

# EUROLAMP®

Pioneers in New Technology !



20  
20

ΚΑΤΑΛΟΓΟΣ ΗΛΕΚΤΡΟΛΟΓΙΚΟΥ ΥΛΙΚΟΥ  
ELECTRICAL EQUIPMENT CATALOGUE



# EUROLAMP®

Pioneers in New Technology !

- ΣΤΟΙΧΕΙΑ ΤΡΑΠΕΖΙΚΩΝ ΛΟΓΑΡΙΑΣΜΩΝ EUROLAMP ABEE
- **EUROLAMP SA BANKING ACCOUNTS**

**ΕΘΝΙΚΗ ΤΡΑΠΕΖΑ:** 224/470122-40  
IBAN: GR79 0110 2240 0000 2244 7012 240

**ΕΘΝΙΚΗ ΤΡΑΠΕΖΑ:** 840/470602-19  
IBAN: GR4801108400000084047060219

**ΤΡΑΠΕΖΑ ΠΕΙΡΑΙΩΣ:** 5229 – 063351 – 500  
IBAN : GR26 0172 2290 0052 2906 3351 500

**ALPHA BANK:** 703 00 2002 016002  
IBAN : GR86 0140 7030 7030 0200 2016 002

**EUROBANK:** 0026.0216.91.0200622333  
IBAN: GR72 0260 2160 0009 1020 0622 333

- ΣΤΟΙΧΕΙΑ ΤΡΑΠΕΖΙΚΩΝ ΛΟΓΑΡΙΑΣΜΩΝ ΒΕΛΓΙΟΥ:  
EUROLAMP BELGIUM SPRL

- **EUROLAMP BELGIUM SPRL BANKING ACCOUNTS**

Beneficiary Name : EUROLAMP BELGIUM SPRL  
Beneficiary Address: 829, Chaussee De Marche BTE2 B-5100  
WIERDE BELGIUM  
**BANK: AXA BANK BELGIUM**  
IBAN ACCOUNT : BE87751207895894  
BIC: AXABBE22

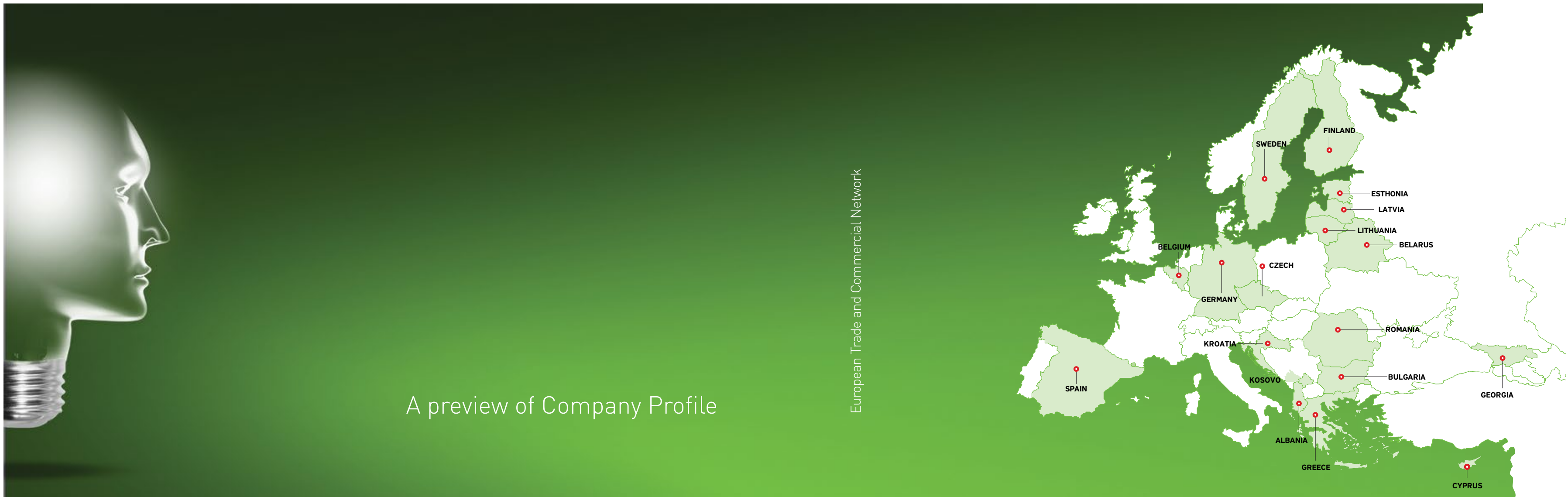

## A preview of Company Profile

**EUROLAMP SA** company was established in 2000 and has its premises in Thessaloniki.

Its increasing route started very early. Initially, only inside Greek territory with items of Lighting and Electrical Equipment.

Then, evolving and constantly worried, by widening its horizons and its products variety, has managed to belong to the leaders of the sector.

Today, as a Leader in **Lighting Technology, Electrical Equipment and Christmas Decoration** items activates in the whole Greek territory as well as in many Balkan and European Union countries. With long lasting and full experience in Production Supervision but also in Trade and Import sector, ensures you directly the supply of :

- **Bulbs and Lighting items of all Technologies,**  
for every domestic and professional demanding use.
- **Electrical Equipment and Accessories,**  
consumables for every domestic and professional need.
- **Christmas Lighting and Decoration Items,**  
with brand name "Magic Christmas" and to a replete codes' variety
- **Electrical Domestic Appliances,**  
such as Heaters, Fans, Dehumidifiers, Air coolers, Insect Repellents and a multitude of other Small Appliances
- **Batteries,**  
for every electric or electronic appliance of domestic use

furthermore, organizes and cares for the whole Production Process of your Private Label (Private Label Production).

Remaining faithfull in its worldview and always in a developing pathway searches, designs and chooses carefully, so as to offer always to its clients...

**the best !**

### EUROLAMP GREECE SA

Diavata Ionia ,  
Thessaloniki Greece P.C 57008  
Tel: 0030 2310 574802  
Fax: 0030 2310 574919  
Site: [www.eurolamp.gr](http://www.eurolamp.gr)  
Email: [info@eurolamp.gr](mailto:info@eurolamp.gr)

### EUROLAMP BELGIUM SPRL

829,B2 Chausse de Marche  
5100 Wierde  
Belgique  
Wallonie +320479172657  
Flandres +320493444162  
email: [info@eurolamp.be](mailto:info@eurolamp.be)

### EUROLAMP CHINA SA

Rm1101-1106. JiuYou Mansion  
No.1158 Huyi Highway  
Nanxiang Town, Jiading District  
201800 Shanghai / P.R. China  
Tel.+86-21-64379558  
Fax: +86-21-64722682  
[www.superwayltd.com](http://www.superwayltd.com)

### EUROLAMP LAMPCENTER

Vastra Finbodavagen 2-4  
130 31 Nacka  
Stockholm  
Svergie  
Tel +46864409800  
Fax +46864409820

• ICONS EXPLANATION • ΕΠΕΞΗΓΗΣΗ ΕΙΚΟΝΙΔΙΩΝ

Voltage		Τάση
	220-240V 50-60Hz	
Amperage		Ένταση Ρεύματος
	2.5A	
Joule		Τζάουλ
	250J	
Herz		Herz
	50-60Hz	
Grounding		Γείωση
	ΓΕΙΩΣΗ GROUNDING	
Cable Cross		Διατομή Καλωδίου
	3x1.5mm	
Cable Length		Μήκος Καλωδίου
	1.5 m	
Ingress Protection		Βαθμός Στεγανότητας
	IP20	
Impact Resist Factor		Δείκτης Ευθραυστότητας
	IK 10	
Schucko Available Holes		Διαθέσιμες Θέσεις Σούκο
	1	
UK Available Holes		Διαθέσιμες Θέσεις UK
	1xUK HOLE	

On-Off Switch		Διακόπτης Λειτουργίας
	ON-OFF SWITCH	
Weight		Βάρος
	1.25	
Color Rendering Index		Δείκτης Χρωματικής Απόδοσης
	(CRI) Ra >80	
Power Factor		Συντελεστής Ισχύος
	PF >0.90	
Life Time Hours		Ώρες Ζωής
	100000h LIFETIME	
On-Off Switches		Κύκλοι Μεταγωγής
	15000 ON-OFF	
Start Time		Χρόνος Έναυσης
	START TIME min: 0.5 sec	
Operating Temperature		Θερμοκρασία Λειτουργίας
	0°C - +50°C OPERATING TEMP.	
Beam Angle		Γωνία Δέσμης Φωτός
	BEAM ANGLE 180° / 360°	
Detection Angle		Γωνία Εύρους Ανίχνευσης
	DETECTION ANGLE 180°	
Bulb Basehold Type		Τύπος Ντουί
	E27	

Installation Height		Ύψος Τοποθέτησης
	INSTALLATION HEIGHT 1.8 - 2.5 m	
Sensor Type		Τύπος Αισθητήρα
	ΑΙΣΘΗΤΗΡΑΣ ΥΠΕΡΥΦΡΩΝ INFRARED MOTION SENSOR	
LED Chip Brand		Μάρκα LED Τσιπ
	CHIP BRAND EPISTAR	
LED Chip Pcs		Αριθμός LED
	LED 30CHIPS	
Sound Alarm Intensity		Ένταση Ήχου Συναγερμού
	SOUND ALARM 85db	
Noise Level		Στάθμη Θορύβου
	ΘΟΡΥΒΟΣ/NOISE 65db	
Sound Volume		Ένταση Ήχου
	SOUND VOLUME 80db	
Day-Night Sensor		Αισθητήρας Ημέρας-Νύχτας
	DAY & NIGHT SENSOR	
Night Light		Φωτάκι Νυχτός
	NIGHT LIGHT	
Easy Reel Button		Κουμπι Αυτόματης Περιέλιξης
	EASY REEL BUTTON	
Διπλή Μόνωση		Double Insulation
	CLASS II	

Timer		Χρονο-Διακόπτης
	ΧΡΟΝΟΔΙΑΚΟΠΤΗΣ TIMER	
Cuting Diameter		Διάμετρος Κοπής για τοποθέτηση
	CUTING DIAMETER 110mm	
Cuting Dimensions		Διαστάσεις Κοπής για τοποθέτηση
	CUTING DIMENSIONS 30x20mm	
Battery Type		Τύπος Μπαταρίας
	LITHIUM 3.7V	
Surge Safe		Προστασία από Υπέρταση
	SURGE SAFE	
Child Safe		Παιδική Προστασία
	CHILD SAFE	
Child Safe		Παιδική Προστασία
	CHILD SAFE	
Child Safe		Παιδική Προστασία
	CHILD SAFE	
Over-Heat Safe		Προστασία από Υπερ-θέρμανση
	OVER HEAT SAFE	
Timer Adjustable Time		Χρόνος Ρύθμισης Χρονοδιακόπτη
	24 HOURS ADJUSTABLE TIME	
Discharge Time		Χρόνος Αποφόρτισης
	150 HOURS DISCHARGE TIME	

• ICONS EXPLANATION • ΕΠΕΞΗΓΗΣΗ ΕΙΚΟΝΙΔΙΩΝ

Air Temper.		Θερμοκρασία Αέρα
	AIR TEMPER. 50°C - 65°C	
Temper. Range of Thermostat		Εύρος Θερμοκρασίας Θερμοστάτη
	TEMPERATURE RANGE OF THERMOSTAT 5°C - 30°C	
Fireproof Material		Πυράντοχο Υλικό
	FIREPROOF MATERIAL UL 94 V-0	
Reset Switch		Κουμπι Επαναφοράς
	RESET SWITCH	
Power Indicator		Φωτεινή Ένδειξη Ισχύος
	POWER INDICATOR	
Function Indicator		Φωτεινή Ένδειξη καλής Λειτουργίας
	FUNCTION INDICATOR	
Data Tranfer Speed		Ταχύτητα Μετάδοσης Δεδομένων
	MAX. 10.2Gbps ETHERNET SPEED	
Telephone Cable Plug		Φις Καλωδίου Τηλεφώνου
	RJ11	
Network Cable Plug		Φις Καλωδίου Δικτύου
	RJ11 RJ45	
Delay Time		Χρόνος Καθυστερήσης
	30sec-10min DELAY TIME	

Energy Class		Ενεργειακή Κλάση
	A+	
Dimmable Device		Δυνατότητα Ρύθμισης Φωτεινότητας
	DIMMABLE	
NOT Dimmable Device		Μη Δυνατότητα Ρύθμισης Φωτεινότητας
	NOT DIMMABLE	
Cable-Reel Wattage		Ισχύς με Καλώδιο τυλιγμένο
	1000W	
Cable NOT Reel Wattage		Ισχύς με Καλώδιο ξετυλιγμένο
	3000W	

• ΠΕΡΙΕΧΟΜΕΝΑ • CONTENTS



PAGES 12 - 14

· ΦΙΣ ΡΕΥΜΑΤΟΣ ΔΙΠΟΛΙΚΑ & ΣΟΥΚΟ  
· PLUG 2 POLE NORMAL & SCHUKO

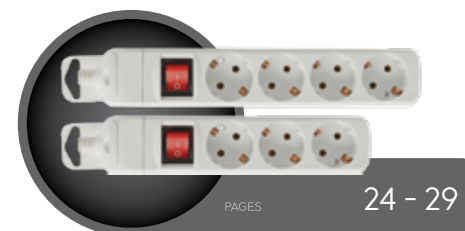

PAGES 24 - 29

· ΠΟΛΥΠΡΙΖΑ ΣΟΥΚΟ  
· SCHUKO SOCKETS



PAGES 38 - 39

· ΓΙΡΛΑΝΤΑ ΕΞΩΤΕΡΙΚΟΥ ΧΩΡΟΥ  
ΕΠΕΚΤΙΝΟΜΗ  
· OUTDOOR STRING LIGHT EXTENDABLE



PAGES 58 - 59

· ΗΛΕΚΤΡ. ΚΟΥΔΟΥΝΙΑ  
· DOORBELLS



PAGES 72

· ΜΟΝΩΤΙΚΕΣ ΤΑΙΝΙΕΣ PVC  
· PVC ELECTRICAL INSULATING TAPES



PAGES 78 - 87

· ΔΙΑΚΟΠΤΕΣ / ΠΡΙΖΕΣ / ΜΠΟΥΤΟΝ  
· SWITCHES / SOCKETS / BUTTONS



PAGES 15 - 17

· ΑΝΤΑΠΟΡΕΣ ΑΣΦΑΛΕΙΑΣ ΣΟΥΚΟ  
· ADAPTORS SCHUKO

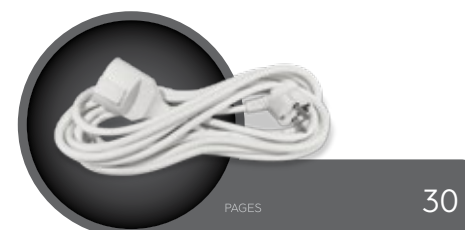

PAGES 30

· ΠΡΟΕΚΤΑΣΕΙΣ ΓΕΡΜΑΝΙΚΩΝ  
ΠΡΟΔΙΑΓΡΑΦΩΝ  
· EXTENSION CORD GERMAN TYPE

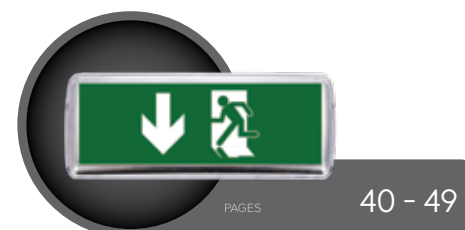

PAGES 40 - 49

· ΕΦΕΔΡΙΚΟΣ ΦΩΤΙΣΜΟΣ  
· EMERGENCY LIGHT



PAGES 60 - 61

· ΘΕΡΜΟΣΤΑΤΕΣ  
· THERMOSTATS

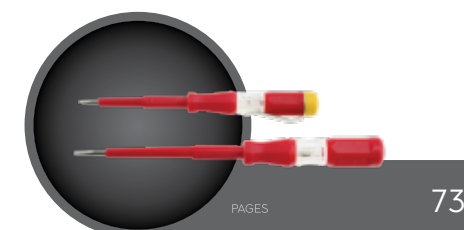

PAGES 73

· ΚΑΤΣΑΒΙΔΙ ΔΟΚΙΜΑΣΤΙΚΟ  
· SCREWDRIVER TESTER

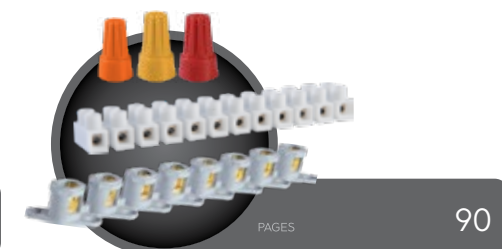

PAGES 90

· ΚΛΕΜΕΣ / ΚΥΠΑΡΙΣΣΑΚΙΑ  
ΚΑΦΕΣ ΚΑΛΩΔΙΩΝ  
· TERMINAL BLOCKS

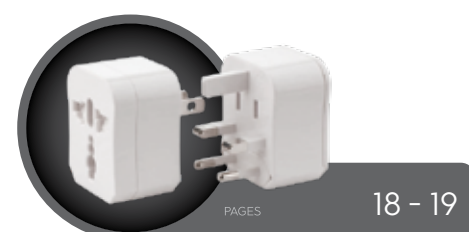

PAGES 18 - 19

· ΤΑΞΙΔΙΟΤΙΚΟΙ ΑΝΤΑΠΟΡΕΣ  
TRAVELING ADAPTORS



PAGES 31 - 35

· ΜΠΑΛΑΝΤΕΖΕΣ  
· CABLE REELS



PAGES 50 - 55

· ΑΝΙΧΝΕΥΤΕΣ ΚΑΠΝΟΥ / ΚΙΝΗΣΗΣ  
· SMOKE ALARMS  
& MOVEMENT DETECTORS



PAGES 62 - 66

· ΕΞΑΕΡΙΣΤΗΡΑΣ ΛΟΥΤΡΟΥ  
· BATH VENTILATION FAN



PAGES 74

· ΨΗΦΙΑΚΑ ΠΟΛΥΜΕΤΡΑ  
· DIGITAL MULTIMETERS

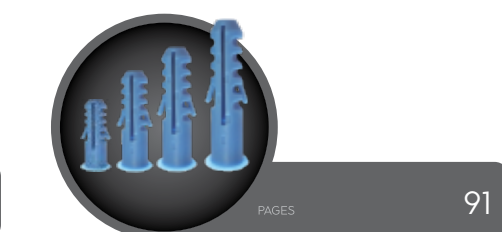

PAGES 91

· ΟΥΠΑ - EXPAND PLUGS

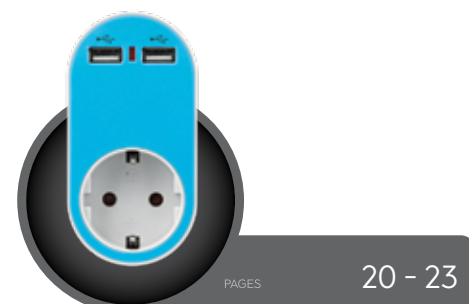

PAGES 20 - 23

· ΑΝΤΑΠΟΡΕΣ ΑΣΦΑΛΕΙΑΣ ΣΟΥΚΟ  
ΜΕ ΘΥΡΕΣ USB  
· SAFETY SCHUKO ADAPTORS  
WITH USB CHARGER



UK TYPE

PAGES 36 - 37

· ΦΙΣ ΡΕΥΜΑΤΟΣ / ΠΟΛΥΠΡΙΖΑ  
ΠΡΟΕΚΤΑΣΗ  
· PLUGS / SOCKETS / EXTENSION



PAGES 56 - 57

· ΦΩΤΟΚΥΤΤΑΡΑ  
· PHOTOCELL SWITCHES



PAGES 67 - 69

· ΣΕΣΟΥΑΡ ΞΕΝΟΔΟΧΕΙΟΥ  
ΣΤΕΓΝΟΤΗΡΑΣ ΧΕΡΙΩΝ  
· HAIR DRYER FOR HOTELS / HAND DRYER

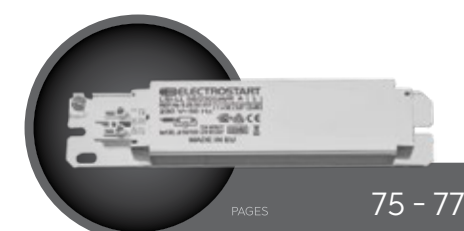

PAGES 75 - 77

· ΜΑΓΝΗΤΙΚΟ BALLAST  
· MAGNETIC BALLAST



PAGES 91

· ΣΥΝΔΕΣΜΟΙ ΚΑΛΩΔΙΩΝ /  
ΔΙΑΚΟΠΤΑΚΙΑ ΕΝΔΙΑΜΕΣΑ  
· WIRE CONNECTORS / MIDDLE SWITCHES



PAGES 92

· ΡΟΚΕΣ · CABLE CLIPS



PAGES 104 - 106

· ΦΩΤΑΚΙΑ ΝΥΧΤΟΣ LED  
· LED NIGHT LIGHTS

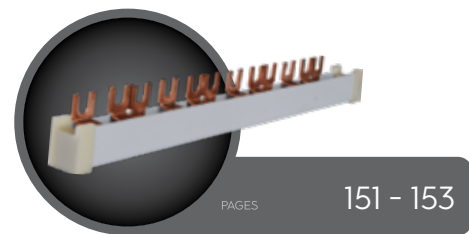

PAGES 151 - 153

· ΓΕΦΥΡΕΣ ΧΑΛΚΟΥ  
· COPPER BUSBARS



PAGES 162 - 164

· ΦΙΣ ΤΗΛΕΦΩΝΟΥ Α.Τ / ΑΝΤΑΠΤΟΡΕΣ  
ΠΡΟΕΚΤΑΣΕΙΣ / ΠΡΙΖΕΣ / ΦΙΛΤΡΑ ADSL  
· TELEPHONE PLUGS / ADAPTORS  
CONNECTORS / ADSL SPLITTER



PAGES 171 - 172

· ΚΑΛΩΔΙΑ ΗΧΕΙΩΝ & ΣΥΝΑΓΕΡΜΟΥ  
· SPEAKER & ALARM CABLES



PAGES 184 - 185

· ΚΥΤΙΑ ΔΙΑΚΟΠΤΟΥ & ΣΥΝΔΕΣΜΟΙ  
· SWITCH BOXES & CONNECTORS

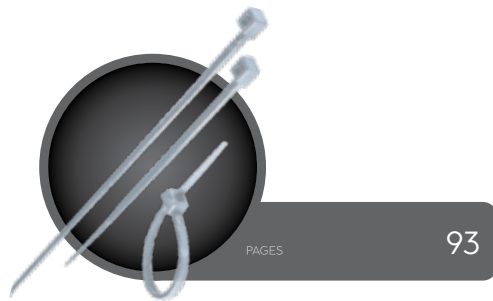

PAGES 93

· ΔΕΜΑΤΙΚΑ · CABLE TIES



PAGES 108 - 133

· ΗΛΕΚΤΡΟΛΟΓΙΚΟ ΥΛΙΚΟ ΡΑΓΑΣ  
· DIN RAIL EQUIPMENT  
FUSE BOXES



PAGES 154 - 155

WALL MOUNTED SOCKETS  
INDUSTRIAL TYPE  
ΠΡΙΖΕΣ ΕΠΙΤΟΙΧΕΣ  
ΒΙΟΜΗΧΑΝΙΚΟΥ ΤΥΠΟΥ



PAGES 165

· ΚΑΛΩΔΙΑ ΤΗΛΕΦΩΝΟΥ /  
ΠΡΟΕΚΤΑΣΕΙΣ ΔΙΚΤΥΟΥ UTP  
· TELEPHONE CABLES / PATCH CORDS UTP

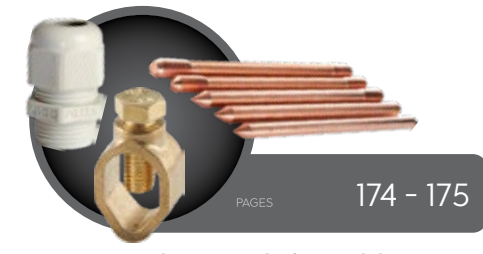

PAGES 174 - 175

· ΓΕΙΩΣΗ ΧΑΛΚΟΥ/ΣΤΥΠΙΟΦΛΗΠΤΕΣ  
ΣΦΙΓΚΤΗΡΑΣ ΓΕΙΩΣΗΣ  
· GROUND CABLE CLAMP/COPPER GROUND  
NYLON CABLE GLANDS



PAGES 186 - 189

· ΣΩΛΗΝΕΣ ΕΥΘΕΙΑΣ & ΣΠΙΡΑΛ  
ΣΤΗΡΙΓΜΑΤΑ ΣΩΛΗΝΩΝ  
· STRAIGHT TUBE & SPIRAL  
SUPPORTS FOR TUBES



PAGES 96 - 98

· ΝΤΟΥΪ ΠΟΡΣΕΛΑΝΗΣ - ΜΕΤΑΛΛΙΚΑ  
ΑΝΤΑΠΤΟΡΕΣ  
· LAMP HOLDERS PORCELAIN - METALLIC  
ADAPTORS



PAGES 134 - 144

· ΚΟΥΤΙΑ ΕΞΩΤΕΡ./ ΗΛΕΚΤΡ. ΠΙΝΑΚΕΣ  
· WATERTIGHT ENCLOSURES  
CONSUMER UNITS



PAGES 156

· ΜΕΤΡΗΤΕΣ ΡΕΥΜΑΤΟΣ ΡΑΓΑΣ  
· DIN RAIL ELECTRIC METERS

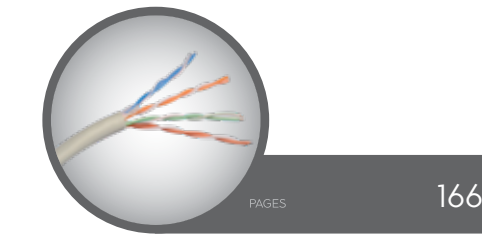

PAGES 166

· ΚΑΛΩΔΙΟ UTP / FTP  
· CABLE UTP / FTP

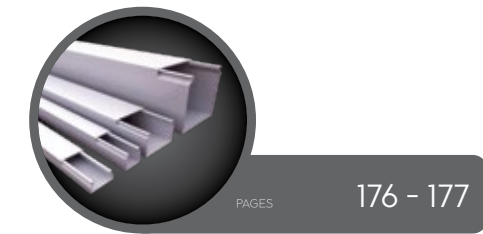

PAGES 176 - 177

· ΚΑΝΑΛΙ ΚΛΕΙΣΤΟΥ ΤΥΠΟΥ  
· CABLE TRUNKING CLOSE TYPE

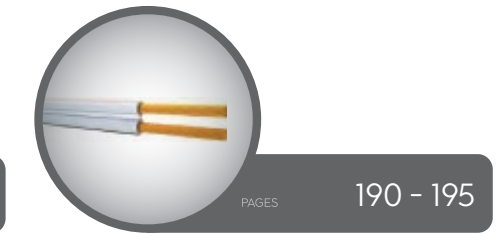

PAGES 190 - 195

· ΚΑΛΩΔΙΑ ΔΙΑΦΟΡΑ  
· SEVERAL CABLES

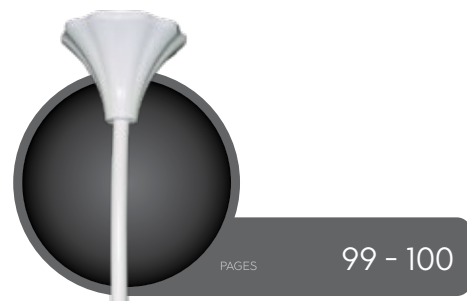

PAGES 99 - 100

· ΝΤΟΥΪ ΚΡΕΜΑΣΤΑ  
· HANGING LAMP HOLDERS



PAGES 145 - 150

· ΑΣΦΑΛΕΙΕΣ LINDNER  
· LINDNER FUSES



PAGES 157

· ΜΕΤΡΗΤΗΣ ΡΕΥΜΑΤΟΣ  
ΑΝΑΛΟΓΙΚΟΣ ΜΟΝΟΦΑΣΙΚΟΣ  
· ELECTRIC METER ANALOG 1 PHASE



PAGES 167 - 169

· ΦΙΣ / ΑΝΤΑΠΤΟΡΕΣ / ΔΙΑΚΛΑΔΩΤΕΣ &  
ΚΑΛΩΔΙΑ ΤΗΛΕΟΡΑΣΗΣ  
· TV PLUGS / ADAPTORS &  
SPLITTERS / CABLES



PAGES 178 - 179

· ΚΑΝΑΛΙΑ ΑΥΤΟΚΟΛΛΗΤΑ / ΔΑΠΕΔΟΥ  
· CABLE TRUNKING ADHESIVE / FLOOR

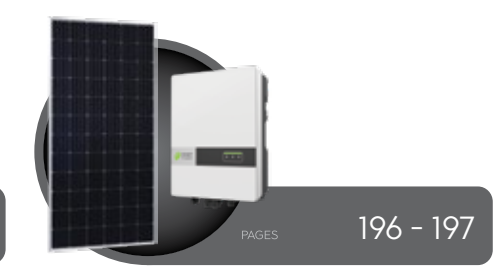

PAGES 196 - 197

· ΦΩΤΟΒΟΛΤΑΪΚΑ ΠΑΝΕΛΣ & INVERTER  
· PHOTOVOLTAIC PANELS & INVERTER



PAGES 101 - 104

· ΝΤΟΥΪ ΜΕΤΑΛΛΙΚΑ / ΡΟΖΕΤΕΣ /  
ΚΑΛΩΔΙΑ ΚΟΡΔΟΝΙ / ΒΑΣΕΙΣ ΓΛΟΜΠΟΥ  
· LAMP HOLDERS METALLIC / CORD CABLE  
IRON CUP PLATES / GLASS GLOBE BASE



PAGES 151 - 153

· ΠΙΝΑΚΕΣ ΕΞΩΤΕΡΙΚΟΙ / ΧΩΝΕΥΤΟΙ  
· FUSE BOXES / NORMAL & MOUNTING



PAGES 158 - 159

· ΧΡΟΝΟΔΙΑΚΟΠΤΗΣ ΡΑΓΑΣ  
· TIMER SWITCH



PAGES 170

· ΚΑΛΩΔΙΑ TV & ΔΟΥΡΥΦΟΡΙΚΑ  
· TV CABLES & SATELLITE



PAGES 180 - 184

· ΚΥΤΙΑ ΓΥΦΟΣΑΝΙΔΑΣ  
· PLASTERBOARD BOXES  
· ΓΩΝΙΕΣ & ΠΛΑΙΣΙΑ ΔΟΜΗΜΕΝΗΣ  
· STRUCTURED ANGLES & ITEMS



PAGES 198 - 205

· ΠΡΟΩΘΗΤΙΚΑ ΣΤΑΝΤ  
· PROMOTIONAL STANDS

Νέα Προϊόντα !  
Brand New Products !



**EUROLAMP®**  
Electrical Equipment

- Φις / Αντάπτορες / Προεκτάσεις / Πολύπριζα / Μπαλαντέζες
- Plugs / Adaptors / Extension Cords / Sockets / Cable Reels

Discover our New Products ►

Discover our Collection ►

• ΦΙΣ ΡΕΥΜΑΤΟΣ ΔΙΠΟΛΙΚΑ & ΣΟΥΚΟ • PLUG 2 POLE NORMAL & SCHUKO



BARCODE	CODE	DESCRIPTION	WATT	REGISTRATION No.	PACKING	PRICE (€)
5206139021489	147-10023	ΦΙΣ ΔΙΠΟΛΙΚΟ ΑΡΣΕΝΙΚΟ PLUG 2 POLE NORMAL MALE	600W	ANAMENETAI IS EXPECTED	1/10/50/200	0.66



BARCODE	CODE	DESCRIPTION	WATT	REGISTRATION No.	PACKING	PRICE (€)
5206139021496	147-10024	ΦΙΣ ΔΙΠΟΛΙΚΟ ΘΥΛΗΚΟ PLUG 2 POLE NORMAL FEMALE	600W	ANAMENETAI IS EXPECTED	1/10/50/200	0.84



BARCODE	CODE	DESCRIPTION	WATT	REGISTRATION No.	PACKING	PRICE (€)
5206139021571	147-10038	ΦΙΣ ΣΟΥΚΟ ΑΡΣΕΝΙΚΟ PLUG SOUKO MALE	3500W	529/5798	1/10/50/200	1.20

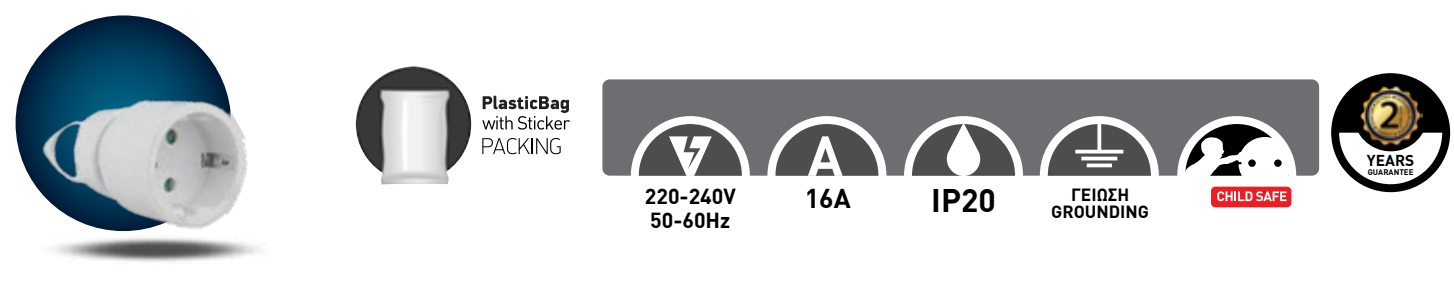

CODE / BARCODE	DESCRIPTION	WATT	REGISTR. No.	PACKING	PRICE (€)
147-10039 5206139021588	ΦΙΣ ΣΟΥΚΟ ΘΥΛΗΚΟ ΜΕ ΠΑΙΔΙΚΗ ΠΡΟΣΤΑΣΙΑ PLUG SCHUKO FEMALE WITH CHILDREN PROTECTION	3840W	529/5799	1/10/50/200	1.26

• ΦΙΣ ΣΟΥΚΟ ΑΡΣΕΝΙΚΟ ΠΛΑΓΕΙΑΣ  
• PLUG SCHUKO MALE RIGHT ANGLE



BARCODE	CODE	DESCRIPTION	WATT	REGISTRATION No.	PACKING	PRICE (€)
5207227048630	147-10025	ΦΙΣ ΣΟΥΚΟ ΑΡΣΕΝΙΚΟ SLIM ΠΛΑΓΕΙΑΣ PLUG SCHUKO MALE SLIM RIGHT ANGLE	3680W	HMPP/00657	1/10/200	1.96



CODE / BARCODE	DESCRIPTION	WATT	REGISTRATION No.	PACKING	PRICE (€)
5206139068118	ΦΙΣ ΣΟΥΚΟ ΑΡΣΕΝΙΚΟ ΠΛΑΓΕΙΑΣ PLUG SCHUKO MALE RIGHT ANGLE	3680W	529/4977	1/10/500	1.13

• ΦΙΣ ΣΟΥΚΟ ΚΑΟΥΤΣΟΥΚ  
• PLUG SCHUKO RUBBER

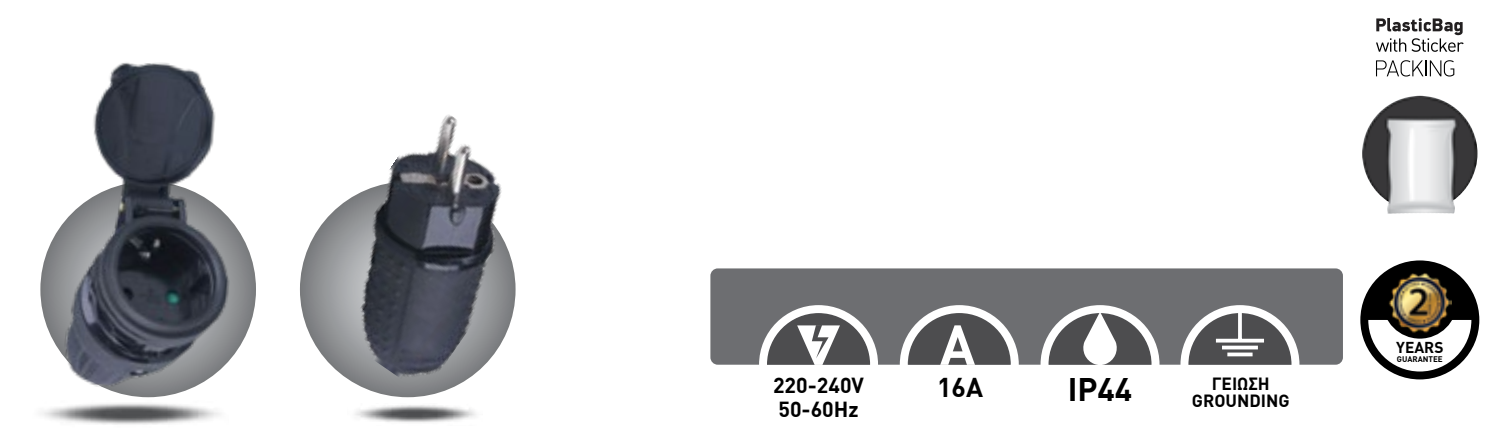

CODE / BARCODE	DESCRIPTION	WATT	REGISTR. No.	PACKING	PRICE (€)
147-10033 5206139021564	ΦΙΣ ΣΟΥΚΟ ΘΥΛΗΚΟ ΚΑΟΥΤΣΟΥΚ ΜΕ ΠΑΙΔΙΚΗ ΠΡΟΣΤΑΣΙΑ PLUG RUBBER FEMALE WITH CHILDREN PROTECTION	3680W	529/5477/2910	1/10/50/100	2.28
147-10032 5206139021557	ΦΙΣ ΣΟΥΚΟ ΑΡΣΕΝΙΚΟ ΚΑΟΥΤΣΟΥΚ PLUG RUBBER MALE IP44 16A 220-240V	3680W	529/5478/2909	1/10/50/100	1.62



- ΦΙΣ ΡΕΥΜΑΤΟΣ ΔΙΠΟΛΙΚΑ & ΣΟΥΚΟ
- PLUG 2 POLE NORMAL & SCHUKO



Nylon Bag & Papercard PACKING

220-240V 50-60Hz 2.5A IP20 2 YEARS GUARANTEE

BARCODE	CODE	DESCRIPTION	WATT	REGISTRATION No.	PACKING	PRICE (€)
5206139099440	800-10023	ΦΙΣ ΔΙΠΟΛΙΚΟ ΑΡΣΕΝΙΚΟ PLUG 2 POLE NORMAL MALE	600W	ANAMENETAI IS EXPECTED	1/10/50/200	0.78



Nylon Bag & Papercard PACKING

220-240V 50-60Hz 2.5A IP20 CHILD SAFE 2 YEARS GUARANTEE

CODE / BARCODE	DESCRIPTION	WATT	REGISTR. No.	PACKING	PRICE (€)
800-10024 5206139081391	ΦΙΣ ΔΙΠΟΛΙΚΟ ΘΥΛΗΚΟ ΜΕ ΠΑΙΔΙΚΗ ΠΡΟΣΤΑΣΙΑ PLUG 2 POLE NORMAL FEMALE WITH CHILDREN PROTECTION	600W	ANAMENETAI IS EXPECTED	1/10/50/200	0.98



Nylon Bag & Papercard PACKING

220-240V 50-60Hz 16A IP20 ΓΕΙΩΣΗ GROUNDING CHILD SAFE 2 YEARS GUARANTEE

BARCODE	CODE	DESCRIPTION	WATT	REGISTRATION No.	PACKING	PRICE (€)
5206139027641	800-10038	ΦΙΣ ΣΟΥΚΟ ΑΡΣΕΝΙΚΟ PLUG SOUKO MALE	3500W	HMPP/00080	1/10/50/200	1.26



Nylon Bag & Papercard PACKING

220-240V 50-60Hz 16A IP20 ΓΕΙΩΣΗ GROUNDING CHILD SAFE 2 YEARS GUARANTEE

CODE / BARCODE	DESCRIPTION	WATT	REGISTR. No.	PACKING	PRICE (€)
800-10039 5206139084460	ΦΙΣ ΣΟΥΚΟ ΘΥΛΗΚΟ ΜΕ ΠΑΙΔΙΚΗ ΠΡΟΣΤΑΣΙΑ PLUG SCHUKO FEMALE WITH CHILDREN PROTECTION	3840W	HMPP/00079	1/10/50/200	1.41

- ΑΝΤΑΠΤΟΡΕΣ ΑΣΦΑΛΕΙΑΣ ΣΟΥΚΟ ΜΕ ΠΑΙΔΙΚΗ ΠΡΟΣΤΑΣΙΑ
- ADAPTORS SCHUKO WITH CHILDREN PROTECTION



Nylon Bag & Papercard PACKING

220-240V 50-60Hz 16A IP20 ΓΕΙΩΣΗ GROUNDING CHILD SAFE 2 YEARS GUARANTEE

CODE / BARCODE	DESCRIPTION	WATT	REGISTR. No.	PACKING	PRICE (€)
147-10000 5206139100009	• ΑΝΤΑΠΤΟΡΑΣ ΑΣΦΑΛΕΙΑΣ ΑΠΟ ΕΝΑ ΣΟΥΚΟ ΣΕ ΔΥΟ ΣΟΥΚΟ ΜΕ ΠΑΙΔΙΚΗ ΠΡΟΣΤΑΣΙΑ • ADAPTOR FROM SCHUKO TO 2 SCHUKO WITH CHILDREN PROTECTION	3500W	529/5733	1/10/200	1.97



Nylon Bag & Papercard PACKING

220-240V 50-60Hz 16A IP20 ΓΕΙΩΣΗ GROUNDING CHILD SAFE 2 YEARS GUARANTEE

CODE / BARCODE	DESCRIPTION	WATT	REGISTR. No.	PACKING	PRICE (€)
147-10001 5206139100016	• ΑΝΤΑΠΤΟΡΑΣ ΑΠΟ ΕΝΑ ΣΟΥΚΟ ΣΕ ΕΝΑ ΣΟΥΚΟ & 2 ΔΙΠΟΛΙΚΑ ΜΕ ΠΑΙΔΙΚΗ ΠΡΟΣΤΑΣΙΑ • ADAPTOR FROM SCHUKO TO 1 SCHUKO & 2 NORMAL WITH CHILDREN PROTECTION	3500W	529/5943	1/10/200	1.98



Nylon Bag & Papercard PACKING

220-240V 50-60Hz 16A IP20 ΓΕΙΩΣΗ GROUNDING CHILD SAFE 2 YEARS GUARANTEE

CODE / BARCODE	DESCRIPTION	WATT	REGISTR. No.	PACKING	PRICE (€)
147-10002 5206139100023	• ΣΟΥΚΟ 3 ΕΞΘΩΝ (ΣΤΑΥΡΟΣ) ΚΑΘΕΤΟ ΜΕ ΠΑΙΔΙΚΗ ΠΡΟΣΤΑΣΙΑ • ADAPTOR SCHUKO TO 3 SCHUKO CROSS VERTICAL WITH CHILDREN PROTECTION	3500W	529/5734	1/10/200	2.58



Nylon Bag & Papercard PACKING

220-240V 50-60Hz 16A IP20 ΓΕΙΩΣΗ GROUNDING CHILD SAFE 2 YEARS GUARANTEE

CODE / BARCODE	DESCRIPTION	WATT	REGISTR. No.	PACKING	PRICE (€)
147-10004 5206139100047	• ΤΑΦ ΣΟΥΚΟ ΣΕ 2 ΣΟΥΚΟ ΜΕ ΠΑΙΔΙΚΗ ΠΡΟΣΤΑΣΙΑ • ADAPTOR SCHUKO TO 2 SCHUKO WITH CHILDREN PROTECTION	3500W	529/5197/2801	1/10/200	2.38

- ΑΝΤΑΠΤΟΡΕΣ ΑΣΦΑΛΕΙΑΣ ΣΟΥΚΟ ΜΕ ΠΑΙΔΙΚΗ ΠΡΟΣΤΑΣΙΑ
- ADAPTORS SCHUKO WITH CHILDREN PROTECTION

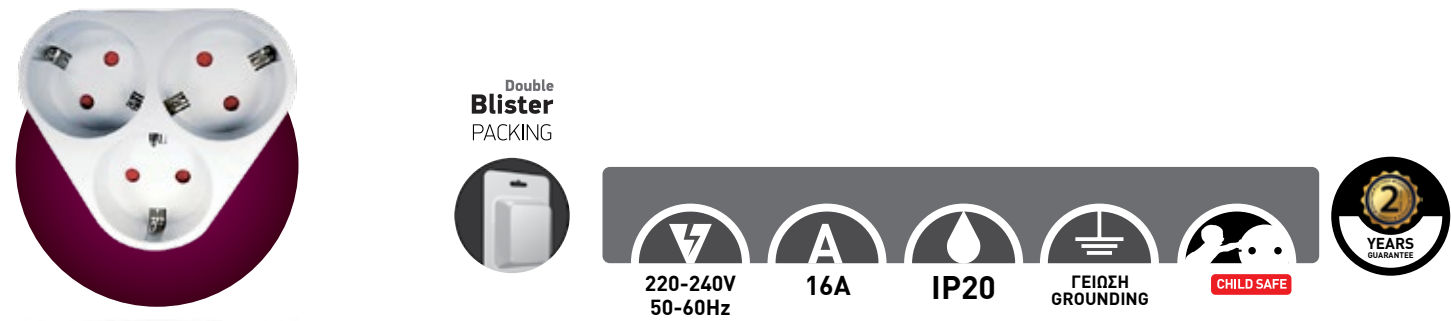

Double Blister PACKING



CODE / BARCODE	DESCRIPTION	WATT	REGISTR. No.	PACKING	PRICE (€)
147-10006 5207227022807	<ul style="list-style-type: none"> <li>• ΑΝΤΑΠΤΟΡΑΣ ΑΠΟ ΣΟΥΚΟ ΣΕ 3 ΣΟΥΚΟ ΟΒΑΛ ΜΕ ΠΑΙΔΙΚΗ ΠΡΟΣΤΑΣΙΑ</li> <li>• ADAPTOR SCHUKO TO 3 SCHUKO OVAL WITH CHILDREN PROTECTION</li> </ul>	3680W	ΑΝΑΜΕΝΕΤΑΙ IS EXPECTED	1/12/48	3.22



Nylon Bag & Papercard PACKING

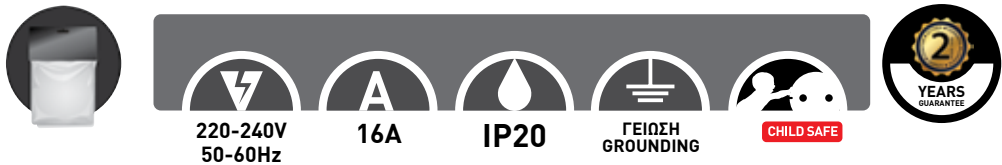

CODE / BARCODE	DESCRIPTION	WATT	REGISTR. No.	PACKING	PRICE (€)
147-10007 5206139052346	<ul style="list-style-type: none"> <li>• ΑΝΤΑΠΤΟΡΑΣ ΑΠΟ ΕΝΑ ΣΟΥΚΟ ΣΕ ΔΥΟ ΣΟΥΚΟ ΜΕ ΔΙΑΚΟΠΤΗ ΜΕ ΠΑΙΔΙΚΗ ΠΡΟΣΤΑΣΙΑ</li> <li>• ADAPTOR FROM SCHUKO TO 2 SCHUKO WITH SWITCH WITH CHILDREN PROTECTION</li> </ul>	3500W	529/4655	1/10/50/200	2.78



Shrink Film PACKING

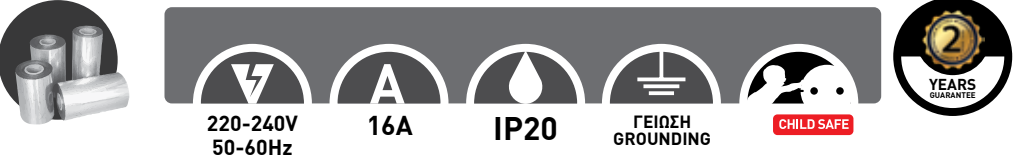

CODE / BARCODE	DESCRIPTION	WATT	REGISTR. No.	PACKING	PRICE (€)
147-10010 5207227004681	<ul style="list-style-type: none"> <li>• ΑΝΤΑΠΤΟΡΑΣ ΑΠΟ ΕΝΑ ΣΟΥΚΟ ΣΕ ΕΝΑ ΣΟΥΚΟ ΜΕ ΔΙΑΚΟΠΤΗ &amp; ΠΑΙΔΙΚΗ ΠΡΟΣΤΑΣΙΑ</li> <li>• ADAPTOR FROM SCHUKO TO 1 SCHUKO WITH SWITCH &amp; WITH CHILDREN PROTECTION</li> </ul>	3680W	529/5945	1/10/200	1.92



Nylon Bag & Papercard PACKING



CODE / BARCODE	DESCRIPTION	WATT	REGISTR. No.	PACKING	PRICE (€)
147-10013 5206139100139	<ul style="list-style-type: none"> <li>• ΑΝΤΑΠΤΟΡΑΣ ΣΟΥΚΟ ΣΕ 2 ΑΠΛΑ ΜΕ ΠΑΙΔΙΚΗ ΠΡΟΣΤΑΣΙΑ</li> <li>• ADAPTOR SCHUKO TO 2 NORMAL WITH CHILDREN PROTECTION</li> </ul>	1100W	529/5942	1/10/200	1.01

- ΑΝΤΑΠΤΟΡΕΣ ΑΣΦΑΛΕΙΑΣ ΣΟΥΚΟ ΜΕ ΠΑΙΔΙΚΗ ΠΡΟΣΤΑΣΙΑ
- ADAPTORS SCHUKO WITH CHILDREN PROTECTION

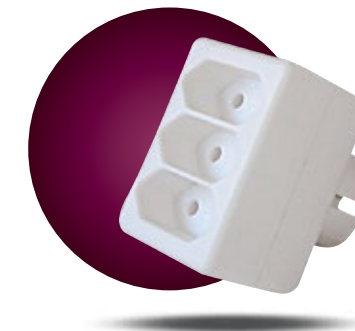

Nylon Bag & Papercard PACKING



CODE / BARCODE	DESCRIPTION	WATT	REGISTR. No.	PACKING	PRICE (€)
147-10014 5206139100146	<ul style="list-style-type: none"> <li>• ΑΝΤΑΠΤΟΡΑΣ ΣΟΥΚΟ ΣΕ 3 ΑΠΛΑ ΜΕ ΠΑΙΔΙΚΗ ΠΡΟΣΤΑΣΙΑ</li> <li>• ADAPTOR SCHUKO TO 3 NORMAL WITH CHILDREN PROTECTION</li> </ul>	1700W	529/5944	1/10/200	1.21



Nylon Bag & Papercard PACKING



CODE / BARCODE	DESCRIPTION	WATT	REGISTR. No.	PACKING	PRICE (€)
147-10019 5206139052384	<ul style="list-style-type: none"> <li>• ΣΟΥΚΟ 3 ΕΞΘΔΩΝ (ΣΤΑΥΡΟΣ) ΟΡΙΖΟΝΤΙΟ ΜΕ ΔΙΑΚΟΠΤΗ &amp; ΠΑΙΔΙΚΗ ΠΡΟΣΤΑΣΙΑ</li> <li>• ADAPTOR SCHUKO TO 3 SCHUKO CROSS HORIZONTAL WITH SWITCH &amp; CHILDREN PROTECTION</li> </ul>	3680W	HMPP/00691	1/5/50/200	3.46

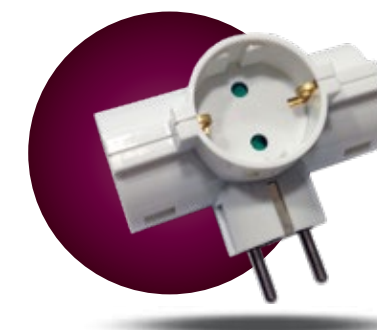

Nylon Bag & Papercard PACKING

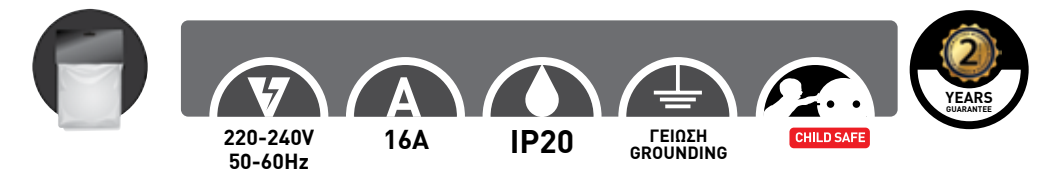

CODE / BARCODE	DESCRIPTION	WATT	REGISTR. No.	PACKING	PRICE (€)
147-10020 5206139051233	<ul style="list-style-type: none"> <li>• ΣΟΥΚΟ 3 ΕΞΘΔΩΝ (ΣΤΑΥΡΟΣ) ΟΡΙΖΟΝΤΙΟ ΜΕ ΠΑΙΔΙΚΗ ΠΡΟΣΤΑΣΙΑ</li> <li>• ADAPTOR SCHUKO TO 3 SCHUKO CROSS HORIZONTAL WITH CHILDREN PROTECTION</li> </ul>	3680W	HMPP/00692	1/5/50/200	3.33

# Ταξιδιωτικοί Αντάπτορες

# Traveling Adaptors

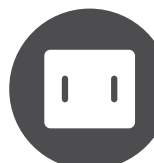
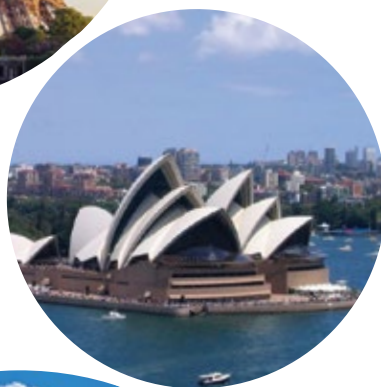

USA / JAPAN  
THAILAND  
TAIWAN



EUROPE  
IRAN / INDIA



GREAT BRITAIN  
HONG KONG  
MALAYSIA  
SINGAPORE



AUSTRALIA  
NEW ZEALAND

\* Παγκόσμια Συμβατότητα  
Καλύπτουν πάνω από 150 Χώρες

\* Worldwide Compatibility  
Cover more than 150 Countries

Discover our Collection ►

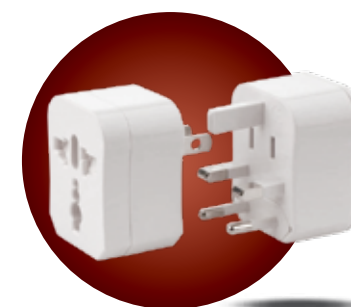

- ΠΑΓΚΟΣΜΙΟΣ ΑΝΤΑΠΤΟΡΑΣ ΤΑΞΙΔΙΟΥ GIFT BOX
- UNIVERSAL TRAVEL ADAPTOR GIFT BOX

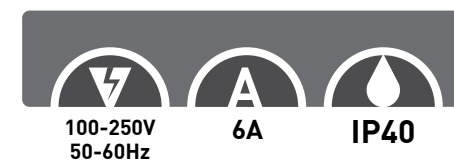

Color  
Box  
PACKING



CODE / BARCODE	DESCRIPTION	WATT	PACKING	PRICE (€)
147-09100 5207227031731	ΤΑΞΙΔΙΩΤΙΚΟΣ ΑΝΤΑΠΤΟΡΑΣ ΑΓΓΛΙΑΣ / TRAVELING ADAPTOR UK	1440W	1/100	5.65



2 USB  
TYPE / CHARGER

5V  
2.1A

Double  
Blister  
PACKING



CODE / BARCODE	DESCRIPTION	WATT	PACKING	PRICE (€)
147-09101 5207227031748	ΤΑΞΙΔΙΩΤΙΚΟΣ ΑΝΤΑΠΤΟΡΑΣ ΑΓΓΛΙΑΣ ΜΕ ΘΥΡΑ USB TRAVELING ADAPTOR UK WITH USB PORT	1440W	1/100	10.85



1 USB  
TYPE / CHARGER

5V • 1A

Double  
Blister  
PACKING

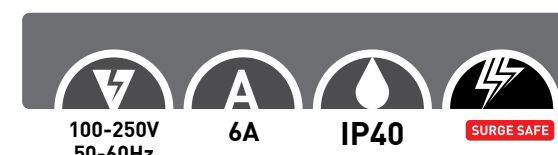

CODE / BARCODE	DESCRIPTION	WATT	PACKING	PRICE (€)
147-09102 5207227031755	ΤΑΞΙΔΙΩΤΙΚΟΣ ΑΝΤΑΠΤΟΡΑΣ ΑΓΓΛΙΑΣ ΜΕ ΘΥΡΑ USB TRAVELING ADAPTOR UK WITH USB PORT	1440W	1/80	8.95



Double  
Blister  
PACKING



CODE / BARCODE	DESCRIPTION	WATT	PACKING	PRICE (€)
147-09103 5207227072468	ΤΑΞΙΔΙΩΤΙΚΟΣ ΑΝΤΑΠΤΟΡΑΣ ΑΓΓΛΙΑΣ ΜΕ ΠΑΙΔΙΚΗ ΠΡΟΣΤΑΣΙΑ TRAVELING ADAPTOR UK WITH CHILDREN PROTECTION	3120W	1/1	1.26



- ΑΝΤΑΠΤΟΡΑΣ ΣΟΥΚΟ ΜΕ ΠΡΟΣΤΑΣΙΑ ΥΠΕΡΤΑΣΗΣ & ΠΑΙΔΙΚΗ ΠΡΟΣΤΑΣΙΑ
- ADAPTOR SCHUKO WITH SURGE PROTECTION & CHILDREN PROTECTION



220-240V 50-60Hz	16A	250J	IP20	1	ΓΕΙΩΣΗ GROUNDING	FUNCTION INDICATOR	SURGE SAFE	CHILD SAFE
CODE / BARCODE	DESCRIPTION	WATT	REGISTR. No.	PACKING	PRICE (€)			
147-09002 5207227018572	• ΑΝΤΑΠΤΟΡΑΣ ΣΟΥΚΟ ΜΕ 3-6 ΜΙΝ ΕΠΑΝΑΦΟΡΑ, ΜΕ ΠΡΟΣΤΑΣΙΑ ΥΠΕΡΤΑΣΗΣ & ΠΑΙΔΙΚΗ ΠΡΟΣΤΑΣΙΑ • ADAPTOR SCHUKO WITH 3-6 MIN RESET, WITH SURGE PROTECTION & CHILDREN PROTECTION	3500W	HMPP/00025	1/10/40	6.27			



- ΑΝΤΑΠΤΟΡΑΣ ΣΟΥΚΟ ΜΕ ΠΡΟΣΤΑΣΙΑ ΥΠΕΡΤΑΣΗΣ & ΠΑΙΔΙΚΗ ΠΡΟΣΤΑΣΙΑ
- ADAPTOR SCHUKO WITH SURGE PROTECTION & CHILDREN PROTECTION



220-240V 50-60Hz	16A	532J	IP20	1	ΓΕΙΩΣΗ GROUNDING	FUNCTION INDICATOR	SURGE SAFE	CHILD SAFE
CODE / BARCODE	DESCRIPTION	WATT	REGISTR. No.	PACKING	PRICE (€)			
147-10029 5206139015198	• ΑΝΤΑΠΤΟΡΑΣ ΣΟΥΚΟ ΜΕ ΠΡΟΣΤΑΣΙΑ ΥΠΕΡΤΑΣΗΣ & ΠΑΙΔΙΚΗ ΠΡΟΣΤΑΣΙΑ • ADAPTOR SCHUKO WITH SURGE PROTECTION & CHILDREN PROTECTION	3680W	529/4029/5941	1/12/48	4.52			



- ΑΝΤΑΠΤΟΡΑΣ ΑΠΟ ΣΟΥΚΟ ΣΕ USB
- ADAPTOR FROM SCHUKO TO USB



				<b>2USB</b> BYΠΕΣ / CHARGER			
220-240V 50-60Hz	16A	IP20	SURGE SAFE		5V DC	2.4 A	
BARCODE	CODE	DESCRIPTION	COLOR	PACKING	PRICE (€)		
5207227018480	147-09000	• ΑΝΤΑΠΤΟΡΑΣ ΑΠΟ ΣΟΥΚΟ ΣΕ 2 USB		1/4/80	9.85		
5207227018510	147-09001	• ADAPTOR FROM SCHUKO TO 2 USB					

- ΑΝΤΑΠΤΟΡΑΣ ΣΟΥΚΟ ΜΕ ΦΩΤΑΚΙ ΝΥΚΤΟΣ, 2 USB, ΒΑΣΗ ΚΙΝΗΤΟΥ
- ADAPTOR SCHUKO WITH NIGHT LIGHT, 2 USB, & MOBILE PHONE STAND



**2USB**  
BYΠΕΣ / CHARGER

5V DC  
 2.4 A



Με στρογγυλό ΦΩΤΑΚΙ ΝΥΧΤΟΣ LED  
With rounded LED NIGHT LIGHT

- Με φωτάκι νυκτός και αισθητήρα μέρας-νύχτας
- With night light and day-night sensor
- Διακόπτης ON/OFF/AUTO για τον αισθητήρα μέρας-νύχτας
- ON / OFF / AUTO Switch for the day-night sensor
- Στην θέση AUTO, το φωτάκι νυκτός ανάβει αυτόματα όταν το φως του περιβάλλοντα χώρου είναι κάτω από 10 LUX
- At AUTO, the night light automatically illuminates when the ambient light is below 10 LUX
- Με βάση στήριξης για το κινητό
- With mobile phone stand

REGISTRATION NUMBER: HMPP/01343

230V 50-60Hz	16A	IP20	1	ΓΕΙΩΣΗ GROUNDING	DAY & NIGHT SENSOR	NIGHT LIGHT	FUNCTION INDICATOR	CHILD SAFE
CODE / BARCODE	DESCRIPTION	WATT	REGISTR. No.	PACKING	PRICE (€)			
147-09003 5207227075681	• ΑΝΤΑΠΤΟΡΑΣ ΣΟΥΚΟ ΜΕ ΦΩΤΑΚΙ ΝΥΚΤΟΣ, 2 USB, ΒΑΣΗ ΚΙΝΗΤΟΥ & ΠΑΙΔΙΚΗ ΠΡΟΣΤΑΣΙΑ • ADAPTOR SCHUKO WITH NIGHT LIGHT, 2 USB, MOBILE PHONE STAND & CHILDREN PROTECTION	3680W	HMPP/01343	1/12/48	12.60			



- ΑΝΤΑΠΤΟΡΕΣ ΑΣΦΑΛΕΙΑΣ ΣΟΥΚΟ ΜΕ 2 ΘΥΡΕΣ USB
- SAFETY SCHUKO ADAPTORS WITH 2 USB CHARGER



**2USB** 5V DC  
ΘΥΡΕΣ / CHARGER 2.4 A

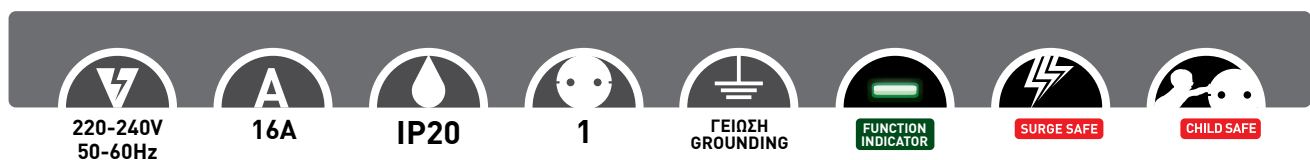

BARCODE	CODE	COLOR	DESCRIPTION	WATT	REGISTR. No.	PACKING	PRICE (€)
5207227018367	147-09010	Grey	• ΑΝΤΑΠΤΟΡΑΣ ΣΟΥΚΟ ΜΕ 2 USB, ΜΕ ΠΡΟΣΤΑΣΙΑ ΥΠΕΡΤΑΣΗΣ & ΠΑΙΔΙΚΗ ΠΡΟΣΤΑΣΙΑ	3680W	HMPP/00008	1/10/40	9.45
5207227018398	147-09011	Pink			HMPP/00009		9.45
5207227018428	147-09012	Green	• ΑΔΑΡΤΟΡ ΣΧΟΥΚΟ ΜΕ 2 USB, ΜΕ ΠΡΟΣΤΑΣΙΑ ΥΠΕΡΤΑΣΗΣ & ΠΑΙΔΙΚΗ ΠΡΟΣΤΑΣΙΑ		HMPP/00011		9.45
5207227018459	147-09013	Blue	• ΑΔΑΡΤΟΡ ΣΧΟΥΚΟ ΜΕ 2 USB, ΜΕ ΠΡΟΣΤΑΣΙΑ ΥΠΕΡΤΑΣΗΣ & ΠΑΙΔΙΚΗ ΠΡΟΣΤΑΣΙΑ		HMPP/00010		9.45

- ΠΟΛΥΠΡΙΖΟ 5 ΘΕΣΕΩΝ ΜΕ ΚΑΛΩΔΙΟ ΚΑΙ ΔΙΑΚΟΠΤΗ, 2 USB, ΒΑΣΗ ΚΙΝΗΤΟΥ & ΠΡΟΣΤΑΣΙΑ ΥΠΕΡΘΕΡΜΑΝΣΗΣ
- SOCKET 5 SCHUKO HOLES, WITH SWITCH, 2 USB, MOBILE PHONE STAND & OVER HEAT PROTECTION
- 3x1.5mm • 1.5m

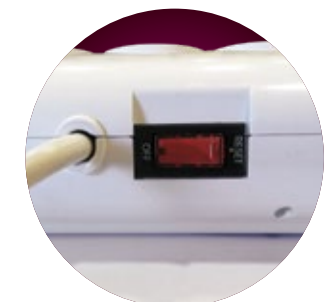

**2USB** 5V DC  
ΘΥΡΕΣ / CHARGER 2.1 A



- Με διακόπτη επαναφοράς • With Reset switch
- Με βάση στήριξης για το κινητό ή το tablet • With mobile phone or tablet stand
- Επιδαπέδια ή επίτοιχνη τοποθέτηση • Floor or wall mounting

REGISTRATION NUMBER: HMPP/01342

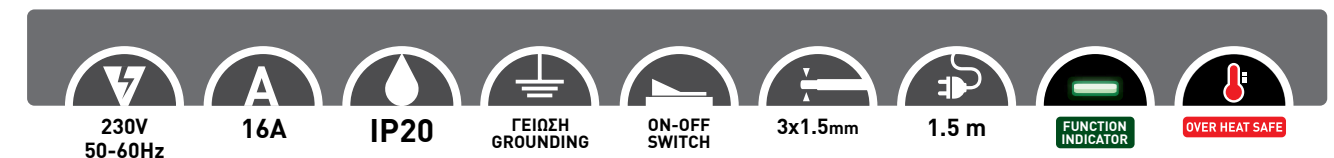

BARCODE	CODE	COLOR	HOLES	WATT	DIMENSIONS (mm):	PACKING	PRICE (€)
5207227075711	147-62170	White	5	3680W	150 x 120 x 55	1/10/30	21.45
5207227075742	147-62171	Black	5	3680W	150 x 120 x 55	1/10/30	21.45

- ΠΟΛΥΠΡΙΖΟ ΣΟΥΚΟ ΜΕ ΠΑΙΔΙΚΗ ΠΡΟΣΤΑΣΙΑ
- SCHUKO SOCKET WITH CHILDREN PROTECTION
- 3x1.5mm
- 1.5m / 3m / 5m



Nylon Bag & Papercard PACKING

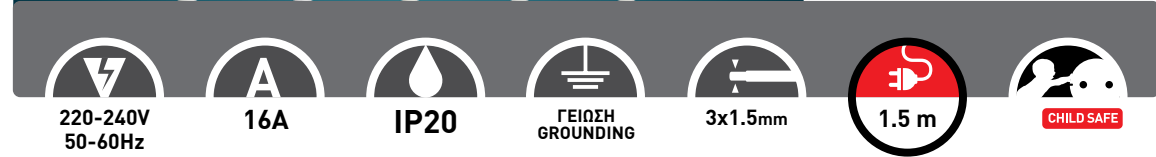

BARCODE	CODE	HOLES	WATT	DIMENSIONS (mm):	REGISTR. No.	PACKING	PRICE (€)
5207227048593	147-62200	2	3680W	110 x 55 x 40	HMPP/00696	1/5/60	3.52
5207227004537	147-62201	3	3680W	145 x 55 x 40	529/5722	1/5/80	3.56
5207227004568	147-62202	4	3680W	195 x 55 x 40	529/5721	1/5/60	4.05
5207227004599	147-62203	5	3680W	240 x 55 x 40	529/5718	1/5/40	4.45
5207227009075	147-62204	6	3680W	280 x 55 x 40	529/5720	1/5/40	4.92



- ΜΗΚΟΣ ΚΑΛΩΔΙΟΥ
- CABLE LENGTH

BARCODE	CODE	HOLES	WATT	DIMENSIONS (mm):	REGISTR. No.	PACKING	PRICE (€)
5207227019593	147-62220	3	3680W	145 x 55 x 40	529/5893	1/5/60	6.12
5207227019623	147-62221	4	3680W	195 x 55 x 40	HMPP/00073	1/5/40	6.46
5207227029806	147-62222	5	3680W	240 x 55 x 40	HMPP/00090	1/5/40	6.56
5207227020841	147-62223	6	3680W	280 x 55 x 40	HMPP/00006	1/5/20	6.82



- ΜΗΚΟΣ ΚΑΛΩΔΙΟΥ
- CABLE LENGTH

BARCODE	CODE	HOLES	WATT	DIMENSIONS (mm):	REGISTR. No.	PACKING	PRICE (€)
5207227030956	147-62240	3	3680W	145 x 55 x 40	HMPP/00739	1/5/40	7.65
5207227009105	147-62241	4	3680W	195 x 55 x 40	529/5719	1/5/30	8.15
5207227020872	147-62242	5	3680W	240 x 55 x 40	HMPP/00007	1/5/30	8.65
5207227072628	147-62243	6	3680W	280 x 55 x 40	ANAMENETAI IS EXPECTED	1/5/30	9.05

- ΠΟΛΥΠΡΙΖΟ ΣΟΥΚΟ ΜΕ ΔΙΑΚΟΠΤΗ & ΠΑΙΔΙΚΗ ΠΡΟΣΤΑΣΙΑ
- SCHUKO SOCKET WITH ON-OFF SWITCH & CHILDREN PROTECTION
- 3x1.5mm
- 1.5m / 3m / 5m



Nylon Bag & Papercard PACKING



BARCODE	CODE	HOLES	WATT	DIMENSIONS (mm):	REGISTR. No.	PACKING	PRICE (€)
5207227009334	147-62210	2	3680W	140 x 55 x 40	529/5479	1/5/60	4.18
5207227008221	147-62211	3	3680W	175 x 55 x 40	529/5723	1/5/80	4.28
5207227008252	147-62212	4	3680W	225 x 55 x 40	529/5716	1/5/60	4.88
5207227008283	147-62213	5	3680W	270 x 55 x 40	529/5724	1/5/40	5.35
5207227004650	147-62214	6	3680W	310 x 55 x 40	HMPP/00740	1/5/40	5.76



- ΜΗΚΟΣ ΚΑΛΩΔΙΟΥ
- CABLE LENGTH

BARCODE	CODE	HOLES	WATT	DIMENSIONS (mm):	REGISTR. No.	PACKING	PRICE (€)
5207227019715	147-62230	3	3680W	175 x 55 x 40	529/5899	1/5/60	5.98
5207227019746	147-62231	4	3680W	225 x 55 x 40	529/5896	1/5/40	6.57
5207227009136	147-62232	5	368W	270 x 55 x 40	529/5900	1/5/40	6.98
5207227072710	147-62233	6	3680W	310 x 55 x 40	ANAMENETAI IS EXPECTED	1/5/40	7.66



- ΜΗΚΟΣ ΚΑΛΩΔΙΟΥ
- CABLE LENGTH

BARCODE	CODE	HOLES	WATT	DIMENSIONS (mm):	REGISTR. No.	PACKING	PRICE (€)
5207227009167	147-62250	3	3680W	175 x 55 x 40	HMPP/00074	1/5/40	7.55
5207227019777	147-62251	4	3680W	225 x 55 x 40	529/5895	1/5/30	8.88
5207227004629	147-62252	5	3680W	270 x 55 x 40	HMPP/00084	1/5/40	9.21
5207227072741	147-62253	6	3680W	310 x 55 x 40	ANAMENETAI IS EXPECTED	1/5/40	9.58



- ΠΟΛΥΠΡΙΖΟ ΣΟΥΚΟ ΜΕ ΔΙΑΚΟΠΤΗ & ΠΑΙΔΙΚΗ ΠΡΟΣΤΑΣΙΑ
- SCHUKO SOCKET WITH ON-OFF SWITCH & CHILDREN PROTECTION
- 3x1.5mm
- 1.5m

Nylon Bag & Papercard PACKING



BARCODE	CODE	HOLES	WATT	DIMENSIONS (mm):	REGISTR. No.	PACKING	PRICE (€)
5207227072659	147-62260	2	3680W	140 x 55 x 40	529/5479	1/5/60	4.12
5207227019654	147-62261	3	3680W	175 x 55 x 40	529/5723	1/5/80	4.28
5207227029776	147-62262	4	3680W	225 x 55 x 40	529/5716	1/5/60	4.88
5207227019685	147-62263	5	3680W	270 x 55 x 40	529/5724	1/5/40	5.35
5207227072680	147-62264	6	3680W	310 x 55 x 40	HMPP/00740	1/5/40	5.76



- ΠΟΛΥΠΡΙΖΟ ΧΡΩΜΑΤΙΣΤΟ / 4 ΣΟΥΚΟ
- COLORED SCHUKO SOCKET / 4 HOLES
- 3x1.5mm • 2m

Nylon Bag & Papercard PACKING



BARCODE	CODE	COLOR	WATT	DIMENSIONS (mm):	REGISTR. No.	PACKING	PRICE (€)
5206139021694	147-62070	Yellow	3680W	225 x 55 x 40	529/5159	1/5/60	6.48
5206139021649	147-62071	Red	3680W	225 x 55 x 40	529/5726	1/5/60	6.48
5206139021687	147-62072	Blue	3680W	225 x 55 x 40	529/5726	1/5/60	6.48
5206139021632	147-62073	Pink	3680W	225 x 55 x 40	529/5726	1/5/60	6.48
5206139021700	147-62074	Black	3680W	225 x 55 x 40	529/5159	1/5/60	6.48

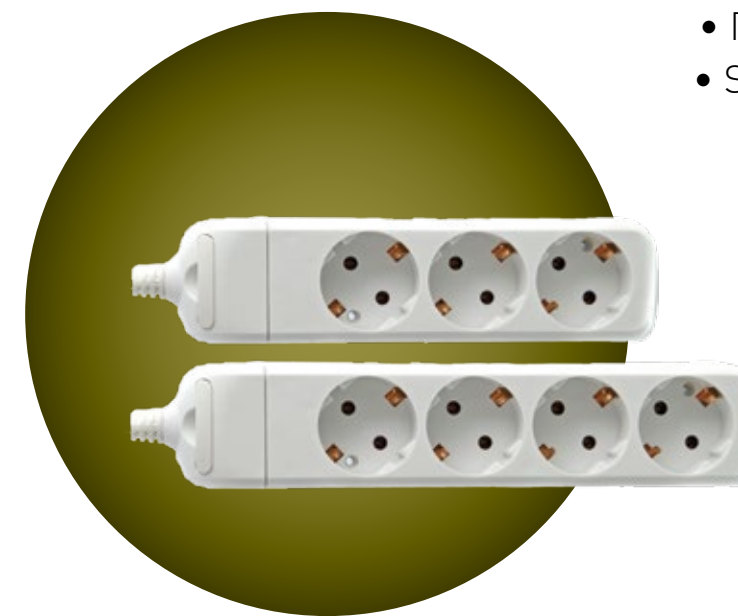

- ΠΟΛΥΠΡΙΖΟ ΣΟΥΚΟ ΧΩΡΙΣ ΚΑΛΩΔΙΟ
- SCHUKO SOCKET WITHOUT CABLE

Nylon Bag & Papercard PACKING



BARCODE	CODE	HOLES	WATT	DIMENSIONS (mm):	REGISTR. No.	PACKING	PRICE (€)
5206139009135	147-62020	3	3680W	215 x 50 x 45	529/5502	1/5/80	2.96
5206139009142	147-62021	4	3680W	260 x 50 x 45	529/5493	1/5/80	3.68

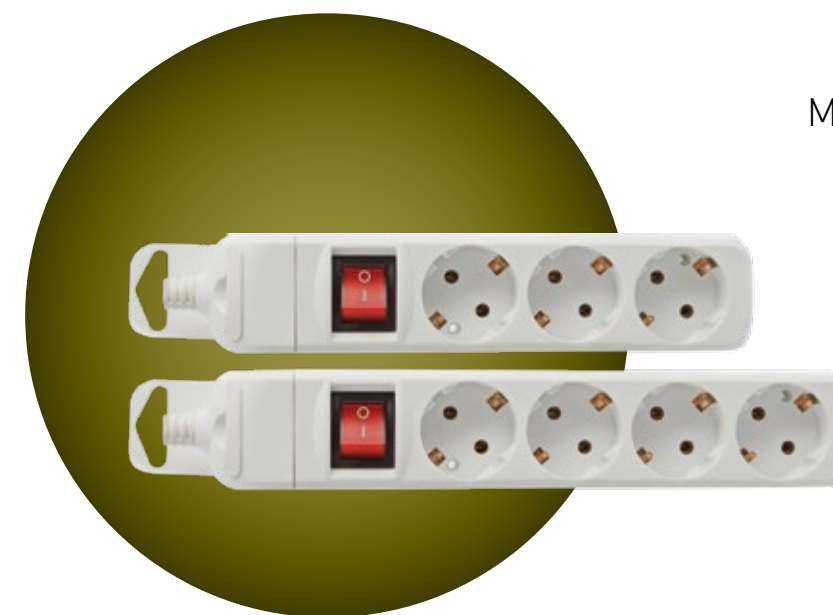

- ΠΟΛΥΠΡΙΖΟ ΣΟΥΚΟ ΜΕ ΔΙΑΚΟΠΤΗ ΧΩΡΙΣ ΚΑΛΩΔΙΟ
- SCHUKO SOCKET WITH ON-OFF SWITCH WITHOUT CABLE

Nylon Bag & Papercard PACKING



BARCODE	CODE	HOLES	WATT	DIMENSIONS (mm):	REGISTR. No.	PACKING	PRICE (€)
5206139009159	147-62025	3	3680W	240 x 50 x 45	529/5488	1/5/80	4.19
5206139009166	147-62026	4	3680W	285 x 50 x 45	529/5503	1/5/80	4.56



**EUROLAMP®**  
Electrical Equipment

- Αποτελεσματική προστασία από ΥΠΕΡΤΑΣΗ, με τα νέας γενιάς Πολύπριζα ΣΟΥΚΟ από την **EUROLAMP**
- Effective protection against SURGE, with the new generation **Schuko Sockets** from **EUROLAMP**

BARCODE	CODE	HOLES	WATT	DIMENSIONS (mm):	REGISTR. No.	PACKING	PRICE (€)
5206139041555	147-62105	3	3500W	280 x 120 x 60	529/4975	1/40	9.70
5206139041579	147-62106	4	3500W	320 x 120 x 60	529/4976	1/40	10.65
5206139077660	147-62107	5	3500W	360 x 120 x 60	529/4030/5940	1/30	11.55





- ΠΡΟΕΚΤΑΣΗ ΜΕ ΠΑΙΔΙΚΗ ΠΡΟΣΤΑΣΙΑ
- EXTENSION CORD WITH CHILDREN PROTECTION
- ΠΛΑΚΕ / FLAT • 2x0.75mm



BARCODE	CODE	CABLE LENGTH (m):	WATT	REGISTRATION. No.	PACKING	PRICE (€)
5207227072772	147-13024	2 m	575	• ANAMENETAI • IS EXPECTED	1/5/50	2.82
5206139201256	147-13025	3 m	575	HMPP/00737	1/5/50	2.92
5206139201263	147-13026	5 m	575	HMPP/00738	1/5/50	3.56

- ΣΟΥΚΟ / SCHUKO • 3x1.5mm

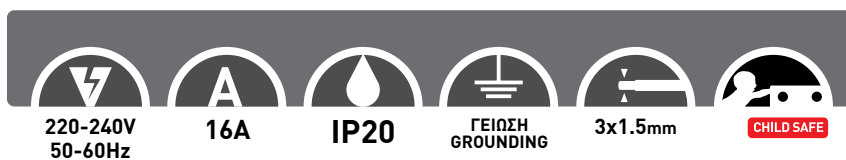
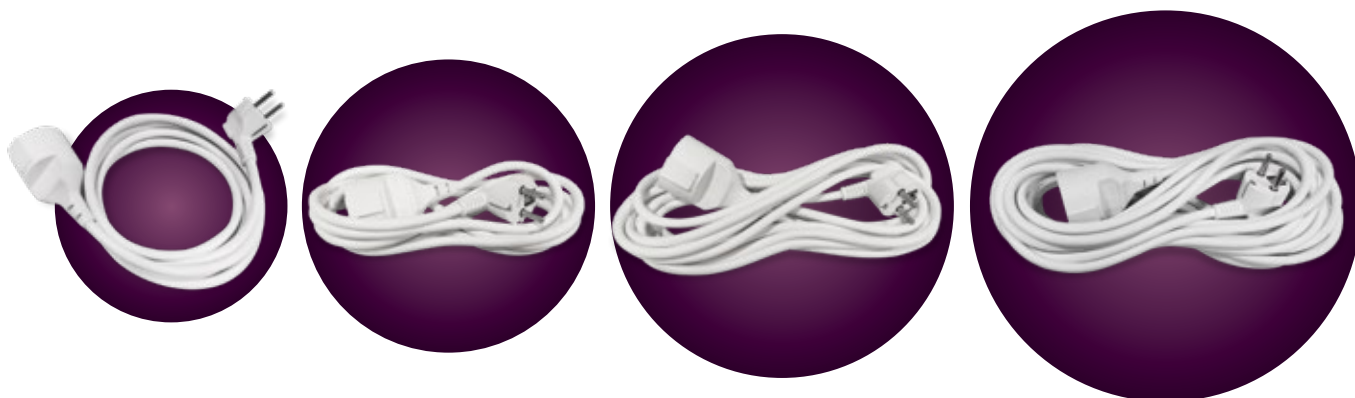

BARCODE	CODE	CABLE LENGTH (m):	WATT	REGISTRATION. No.	PACKING	PRICE (€)
5207227037955	147-13015	2 m	3680W	HMPP/01344	1/5/50	4.78
5206139201164	147-13016	3 m	3680W	HMPP/00082	1/5/50	6.08
5206139201171	147-13017	5 m	3680W	HMPP/00083	1/5/30	8.65
5206139201195	147-13019	10 m	3680W	HMPP/00072	1/5/20	12.96

- ΜΠΑΛΑΝΤΕΖΑ ΣΥΝΕΡΓΕΙΟΥ ΜΕ ΔΙΑΚΟΠΤΗ ΚΑΙ 5m ΚΑΛΩΔΙΟ
- WORKING LAMP WITH SWITCH & EXTENSION 5m

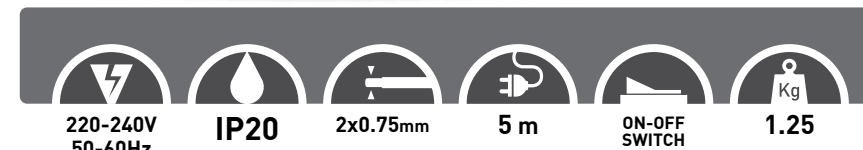

BARCODE	CODE	BULB BASE	BULB TYPE	max. WATT	mm	mm	PACKING	PRICE (€)
5206139440006	147-47000	E27	LED or HALOGEN	10 W 42 W	410	91	1/30	7.85

- ΜΠΑΛΑΝΤΕΖΑ ΜΕ ΠΡΟΣΤΑΣΙΑ ΥΠΕΡΘΕΡΜΑΝΣΗΣ & ΠΑΙΔΙΚΗ ΠΡΟΣΤΑΣΙΑ
- CABLE REEL WITH OVER HEAT PROTECTION & CHILDREN PROTECTION
- ΣΟΥΚΟ / SCHUKO
- 3x1.5mm



REGISTRATION NUMBERS:	
147-47040	HMPP/01324
147-47041	HMPP/01323
147-47042	HMPP/01326
147-47043	HMPP/01325

PlasticBag with Sticker PACKING

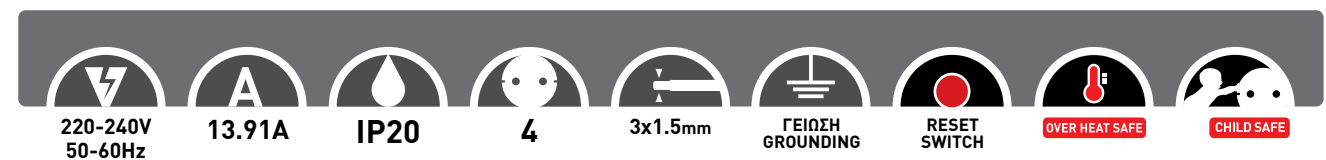

BARCODE	CODE	CABLE LENGTH (m):	WATT	DIMENSIONS (mm):	WEIGHT (kg):	PACKING	PRICE (€)
5206139084163	147-47040	3 m	3200W	220 x 190 x 70	0.560	1/20	9.85
5206139088079	147-47041	5 m	3200W	220 x 275 x 75	0.890	1/10	12.65
5206139088376	147-47042	10 m	3200W	220 x 275 x 75	1.580	1/10	18.60
5206139088796	147-47043	15 m	3200W	220 x 275 x 95	1.900	1/10	23.85



- ΜΠΑΛΑΝΤΕΖΑ ΚΑΡΟΥΛΙ ΧΩΡΙΣ ΚΑΛΩΔΙΟ ΜΕ ΠΡΟΣΤΑΣΙΑ ΥΠΕΡΘΕΡΜΑΝΣΗΣ & ΠΑΙΔΙΚΗ ΠΡΟΣΤΑΣΙΑ
- CABLE REEL COIL WITHOUT CABLE WITH OVER HEAT PROTECTION & CHILDREN PROTECTION

REGISTRATION NUMBER: ANAMENETAI / IS EXPECTED

CartonBox with Sticker PACKING



BARCODE	CODE	WATT	DIMENSIONS (mm):	WEIGHT (kg):	PACKING	PRICE (€)
5207227074714	147-47080	3600W	299 x 380 x 180	1.050	1/4	18.85

- ΜΠΑΛΑΝΤΕΖΑ ΚΑΡΟΥΛΙ, ΠΡΟΣΤΑΣΙΑ ΥΠΕΡΘΕΡΜΑΝΣΗΣ & ΠΑΙΔΙΚΗ ΠΡΟΣΤΑΣΙΑ
  - CABLE REEL COIL, OVER HEAT PROTECTION & CHILDREN PROTECTION
- 3x1.5mm**



- ΜΠΑΛΑΝΤΕΖΑ ΚΑΡΟΥΛΙ, ΠΡΟΣΤΑΣΙΑ ΥΠΕΡΘΕΡΜΑΝΣΗΣ & ΠΑΙΔΙΚΗ ΠΡΟΣΤΑΣΙΑ
  - CABLE REEL COIL, OVER HEAT PROTECTION & CHILDREN PROTECTION
- 3x2.5mm**

BROWNBOX with Sticker PACKING



REGISTRATION NUMBER: HMPP/01322



BARCODE	CODE	CABLE LENGTH (m):	WATT	DIMENSIONS (mm):	WEIGHT (kg):	PACKING	PRICE (€)
5207227048609	147-47031	30 m	3200W	265 x 370 x 175	4.200	1/1	62.20



REGISTRATION NUMBER: HMPP/01366

REGISTRATION NUMBER: HMPP/01367

REGISTRATION NUMBER: HMPP/01365

BROWNBOX with Sticker PACKING

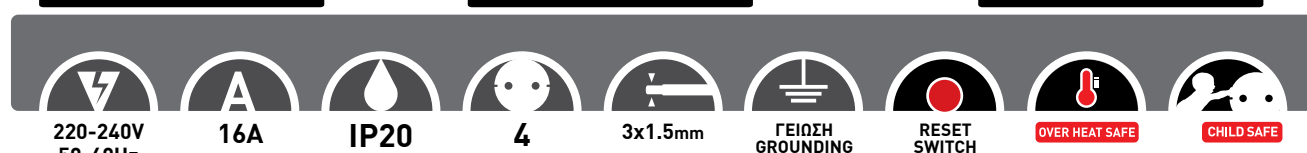

BARCODE	CODE	CABLE LENGTH (m):	WATT	DIMENSIONS (mm):	WEIGHT (kg):	PACKING	PRICE (€)
5206139088970	147-47044	15 m	3000W	210 x 270 x 160	2.350	1/1	25.60
5206139089038	147-47045	25 m	3000W	250 x 320 x 170	3.700	1/1	39.55
5206139110152	147-47025	50 m	3000W	280 x 350 x 200	6.300	1/1	62.45



- ΜΠΑΛΑΝΤΕΖΑ ΚΑΡΟΥΛΙ, ΠΡΟΣΤΑΣΙΑ ΥΠΕΡΘΕΡΜΑΝΣΗΣ & ΠΑΙΔΙΚΗ ΠΡΟΣΤΑΣΙΑ
  - CABLE REEL COIL, OVER HEAT PROTECTION & CHILDREN PROTECTION
- 3x1.5mm**

Color Box PACKING



REGISTRATION NUMBER: HMPP/01361



BARCODE	CODE	CABLE LENGTH (m):	WATT	DIMENSIONS (mm):	WEIGHT (kg):	PACKING	PRICE (€)
5207227041839	147-47046	40 m	3000W	280 x 350 x 210	6.300	1/1	71.80

- ΜΠΑΛΑΝΤΕΖΑ ΧΛΟΟΚΟΠΤΙΚΟΥ ΠΡΟΣΤΑΣΙΑ ΥΠΕΡΘΕΡΜΑΝΣΗΣ & ΠΑΙΔΙΚΗ ΠΡΟΣΤΑΣΙΑ

- CABLE REEL FOR LAWN MOWER, OVER HEAT PROTECTION & CHILDREN PROTECTION

• 3x1.5mm



BROWN BOX with Sticker PACKING



REGISTRATION NUMBER: ANAMENETAI / IS EXPECTED

220-240V 50-60Hz	16A	IP44	1	3x1.5mm	ΓΕΙΩΣΗ GROUNDING	RESET SWITCH	OVER HEAT SAFE	CHILD SAFE	BARCODE	CODE	CABLE LENGTH (m):	WATT	DIMENSIONS (mm):	WEIGHT (Kgr):	PACKING	PRICE (€)
5207227072789	147-47049	27 + 3 m	3000W	280 x 350 x 210	5.400	1/1	34.65									

- ΜΠΑΛΑΝΤΕΖΑ ΤΟΙΧΟΥ, ΜΕ ΕΠΑΝΑΦΟΡΑ & ΠΡΟΣΤΑΣΙΑ ΥΠΕΡΘΕΡΜΑΝΣΗΣ,

- WALL MOUNTED CABLE REEL, RETRACTABLE, WITH OVER HEAT PROTECTION,

• 3x1.5mm

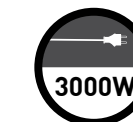

Color Box PACKING



REGISTRATION NUMBER: ANAMENETAI / IS EXPECTED

230V 50Hz	16A	IP20	1	3x1.5mm	ΓΕΙΩΣΗ GROUNDING	FUNCTION INDICATOR	OVER HEAT SAFE	CHILD SAFE	BARCODE	CODE	CABLE LENGTH (m):	WATT	DIMENSIONS (mm):	WEIGHT (Kgr):	PACKING	PRICE (€)
5207227063459	147-47201	8+2 m	1000W 3000W	335 x 285 x 170	4.600	1/2	73.60									

- ΜΠΑΛΑΝΤΕΖΑ ΚΑΡΟΥΛΙ, ΜΕ ΕΠΑΝΑΦΟΡΑ & ΠΡΟΣΤΑΣΙΑ ΥΠΕΡΘΕΡΜΑΝΣΗΣ,

**ΑΥΤΟΜΑΤΗ ΠΕΡΙΕΛΙΞΗ**

- CABLE REEL COIL, RETRACTABLE, WITH OVER HEAT PROTECTION,

**REEL EASY TECHNOLOGY**

• 3x1.5mm • 15m • IP44



Color Box PACKING



REGISTRATION NUMBER: HMPP/01333

230V 50Hz	13.04A	IP44	4	3x1.5mm	ΓΕΙΩΣΗ GROUNDING	EASY REEL BUTTON	OVER HEAT SAFE	CHILD SAFE	BARCODE	CODE	CABLE LENGTH (m):	WATT	DIMENSIONS (mm):	WEIGHT (Kgr):	PACKING	PRICE (€)
5207227063435	147-47200	15 m	1000W 3000W	305 x 345 x 180	5.500	1/2	78.40									



## EUROLAMP®

Electrical Equipment

- ΦΙΣ ΡΕΥΜΑΤΟΣ ΤΥΠΟΥ UK
- PLUG NORMAL TYPE UK

**Nylon Bag & Papercard PACKING**

220-240V 50-60Hz 13A IP20 ΓΕΙΩΣΗ GROUNDING

BARCODE	CODE	DESCRIPTION	WATT	STANDARDS	PACKING	PRICE (€)
5206139067920	147-10021	ΦΙΣ ΡΕΥΜΑΤΟΣ UK PLUG NORMAL MALE UK	3120W	BS1363	1/50/200	1.72
5206139067937	147-10022	ΦΙΣ ΘΗΛΥΚΟ UK ΜΕ ΠΑΙΔΙΚΗ ΠΡΟΣΤΑΣΙΑ PLUG UK WITH CHILDREN PROTECTION	3120W	BS1363	1/50/200	1.56

- ΑΝΤΑΠΤΟΡΑΣ UK 3 ΘΕΣΕΩΝ
- ADAPTOR UK 3 HOLES

**Nylon Bag & Papercard PACKING**

220-240V 50-60Hz 13A IP20 ΓΕΙΩΣΗ GROUNDING CHILD SAFE

BARCODE	CODE	DESCRIPTION	WATT	STANDARDS	PACKING	PRICE (€)
5206139067913	147-10017	ΑΝΤΑΠΤΟΡΑΣ UK 3 ΘΕΣΕΩΝ ΜΕ ΠΑΙΔΙΚΗ ΠΡΟΣΤΑΣΙΑ ADAPTOR UK 3 HOLES WITH CHILDREN PROTECTION	3120W	BS1363	1/50/200	2.58

- ΠΟΛΥΠΡΙΖΑ UK
- SOCKETS UK

**Color Box PACKING**

220-240V 50-60Hz 13A IP20 ΓΕΙΩΣΗ GROUNDING 3x1.25mm 3 m CHILD SAFE

BARCODE	CODE	HOLES	WATT	DIMENSIONS (mm):	STANDARDS	PACKING	PRICE (€)
5206139067852	147-62300	2 UK	3120W	275 x 100 x 50	BS1363-2	1/40	8.15
5206139067869	147-62302	4 UK	3120W	325 x 105 x 50	BS1363-2	1/40	8.95

**Color Box PACKING**

220-240V 50-60Hz 13A IP20 ΓΕΙΩΣΗ GROUNDING 3x1.25mm 3 m ON-OFF SWITCH FOR EACH HOLE CHILD SAFE

BARCODE	CODE	HOLES	WATT	DIMENSIONS (mm):	STANDARDS	PACKING	PRICE (€)
5206139006639	147-62312	4 UK	3120W	350 x 100 x 50	BS1363-2	1/40	10.85
5206139019011	147-62314	6 UK	3120W	475 x 95 x 50	BS1363-2	1/30	12.95

**Color Box PACKING**

220-240V 50-60Hz 13A IP20 530J ΓΕΙΩΣΗ GROUNDING 3x1.25mm 3 m SURGE SAFE CHILD SAFE

BARCODE	CODE	HOLES	WATT	DIMENSIONS (mm):	STANDARDS	PACKING	PRICE (€)
5206139067876	147-62350	2 UK	3120W	275 x 100 x 50	BS1363-2	1/40	8.90
5206139067883	147-62352	4 UK	3120W	325 x 105 x 50	BS1363-2	1/40	10.45

- ΠΡΟΕΚΤΑΣΗ UK
- EXTENSION UK TYPE

**Nylon Bag & Papercard PACKING**

220-240V 50-60Hz 13A IP20 ΓΕΙΩΣΗ GROUNDING 3x1.25mm CHILD SAFE

BARCODE	CODE	CABLE LENGTH (m):	WATT	STANDARDS	PACKING	PRICE (€)
5206139067890	147-13041	3 m	3120W	BS1363	1/5/50	6.85
5206139067906	147-13042	5 m	3120W	BS1363	1/5/50	8.95

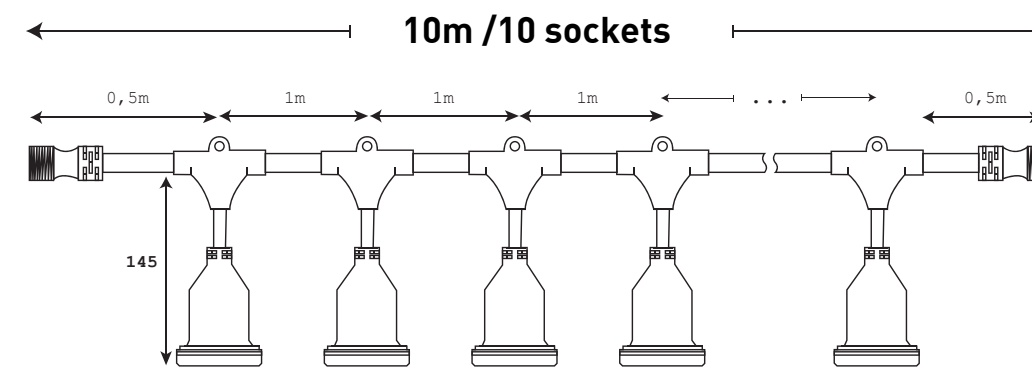

Color  
Box  
PACKING



- ΓΙΡΛΑΝΤΑ ΕΙΣΩΤΕΡΙΚΟΥ ΧΩΡΟΥ **ΕΠΕΚΤΕΙΝΟΜΕΝΗ 10m** / ΜΕ **10** ΝΤΟΥΙ **E27**
- OUTDOOR STRING LIGHT **EXTENDABLE 10m** / WITH **10** LAMP HOLDERS **E27**
- **IP44**

220-240V 50-60Hz	16A	IP44	10xE27	2x1mm	ΓΕΙΩΣΗ GROUNDING	-20°C - +60°C OPERATING TEMP.

BARCODE	CODE	TOTAL LENGTH (m):	WATT	BULB TYPE	max. WATT	WEIGHT (kg):	PACKING	PRICE (€)
5207227026850	147-47090	10+1 m	2000	LED or HALOGEN	10 W 28 W	0.245	1/4	45.25



**EUROLAMP**<sup>®</sup>  
Lighting

- Εφεδρικός Φωτισμός / Πλαφονιέρες με Ανιχνευτή Κίνησης
- Emergency Lights / Ceiling Lights with Movement Sensor

Discover our Collection ►



- ΕΦΕΔΡΙΚΟΣ ΦΩΤΙΣΜΟΣ
- EMERGENCY LIGHT
- LED

• Lumen ανα Επίπεδο Λειτουργίας:  
Χαμηλό: 60-70 lm / Υψηλό: 120-150 lm

• Lumen per Function Level:  
Low: 60-70 lm / High: 120-150 lm

• Χρόνος Φόρτισης Μπαταρίας: 16-24h  
• Battery Charging Time: 16-24h

• Χρόνος Αποφόρτισης Μπαταρίας:  
min:10h, max:6h  
• Battery Discharge Time:  
min:10h, max:6h

COLOR  
Box  
PACKING



110-240V 50-60Hz	100V/15mA 220V/7mA	IP20	LITHIUM 3.7V	30CHIPS	0°C ~ +50°C OPERATING TEMP.	0.186

BARCODE	CODE	WATT	KELVIN	mm	mm	mm	PACKING	PRICE (€)
5206139020819	147-55152	1.5W	6500K	220	65	33	1/30	12.95



- ΕΦΕΔΡΙΚΟΣ ΦΩΤΙΣΜΟΣ
- EMERGENCY LIGHT
- LED

• Χρόνος Φόρτισης Μπαταρίας: 12-15h  
• Battery Charging Time: 12-15h

• Χρόνος Αποφόρτισης Μπαταρίας: 2h  
• Battery Discharge Time: 2h

COLOR  
Box  
PACKING



220-240V 50-60Hz	IP40	Li-ion 2200mA	2CHIPS	FUNCTION INDICATOR	0°C ~ +40°C OPERATING TEMP.	0.275

BARCODE	CODE	WATT	KELVIN	LUMEN/WATT	TOTAL LUMEN	mm	mm	mm	PACKING	PRICE (€)
5207227075599	145-28102	4W	6000K - 7500K	45 lm/Watt	180 lm	40	130		1/10	38.80



• Lumen ανα Επίπεδο Λειτουργίας:  
Χαμηλό: 60 lm / Υψηλό: 120 lm

• Lumen per Function Level:  
Low: 60 lm / High: 120 lm

• Χρόνος Φόρτισης Μπαταρίας: 20-24h  
• Battery Charging Time: 20-24h

• Χρόνος Αποφόρτισης Μπαταρίας: 3-4h  
• Battery Discharge Time: 3-4h

COLOR  
Box  
PACKING



220-240V 50-60Hz	IP20	Li-ion 1200mA	30CHIPS	FUNCTION INDICATOR	0°C ~ +40°C OPERATING TEMP.	0.162

BARCODE	CODE	WATT	KELVIN	LUMEN/WATT	CONNECTION	mm	mm	mm	PACKING	PRICE (€)
5207227075544	145-28000	2W	6000K-7500K	60 lm/Watt	ΦΙΣ / PLUG	202	55	28	1/40	9.75

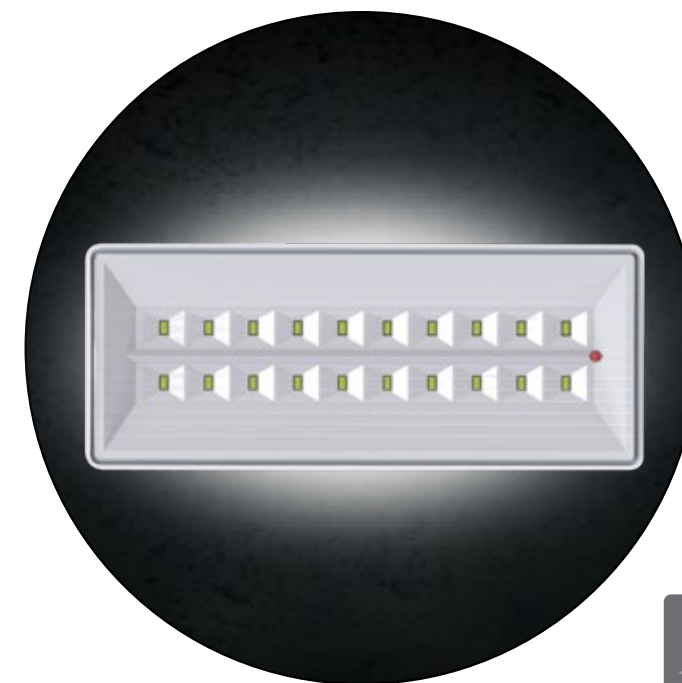

• Χρόνος Φόρτισης Μπαταρίας: 20-24h  
• Battery Charging Time: 20-24h

• Χρόνος Αποφόρτισης Μπαταρίας: 3-4h  
• Battery Discharge Time: 3-4h

COLOR  
Box  
PACKING



220-240V 50-60Hz	IP43	Li-ion 2200mA	20CHIPS	FUNCTION INDICATOR	0°C ~ +40°C OPERATING TEMP.	0.450

BARCODE	CODE	WATT	KELVIN	LUMEN/WATT	TOTAL LUMEN	mm	mm	mm	PACKING	PRICE (€)
5207227075582	145-28101	3W	6000K - 7500K	80 lm/Watt	240 lm	260	108	42	1/20	24.85

• ΕΦΕΔΡΙΚΟΣ ΦΩΤΙΣΜΟΣ • EMERGENCY LIGHT  
• LED

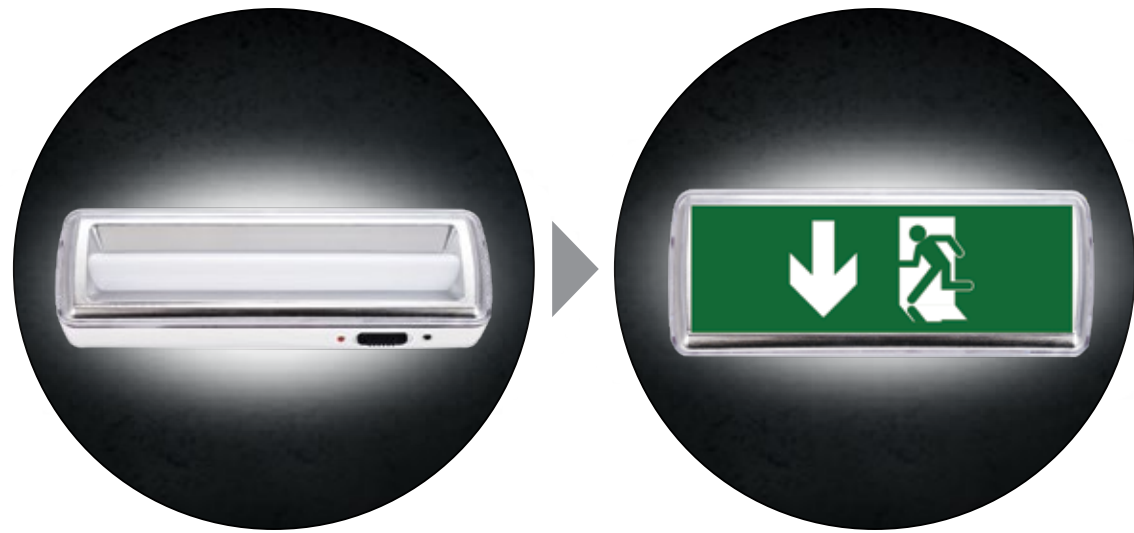

• Χρόνος Φόρτισης Μπαταρίας: 20-24h • Battery Charging Time: 20-24h  
• Χρόνος Αποφόρτισης Μπαταρίας: 2-3h • Battery Discharge Time: 2-3h

• Lumen ανα Επίπεδο Λειτουργίας:  
Χαμηλό: 80 lm / Υψηλό: 200 lm  
• Lumen per Function Level:  
Low: 80 lm / High: 200 lm

220-240V 50-60Hz IP20 20CHIPS Li-ion 1500mA FUNCTION INDICATOR 0°C ~ +40°C OPERATING TEMP. 0.240

BARCODE	CODE	WATT	KELVIN	LUMEN/WATT	CONNECTION	mm	mm	mm	PACKING	PRICE (€)
5207227075568	145-28010	4W	6000K-7500K	50 lm/Watt	ΦΙΣ / PLUG	205	68	31	1/20	12.85

• ΕΦΕΔΡΙΚΟΣ ΦΩΤΙΣΜΟΣ  
• EMERGENCY LIGHT  
• LED



COLOR Box PACKING



• Χρόνος Φόρτισης Μπαταρίας: 20-24h  
• Battery Charging Time: 20-24h  
• Χρόνος Αποφόρτισης Μπαταρίας: 2-3h  
• Battery Discharge Time: 2-3h

220-240V 50-60Hz IP43 Li-ion 1200mA 10CHIPS FUNCTION INDICATOR 0°C ~ +40°C OPERATING TEMP. 0.420

BARCODE	CODE	WATT	KELVIN	LUMEN/WATT	TOTAL LUMEN	mm	mm	mm	PACKING	PRICE (€)
5207227075575	145-28100	3W	6000K-7500K	40 lm/Watt	120 lm	260	108	42	1/20	21.60

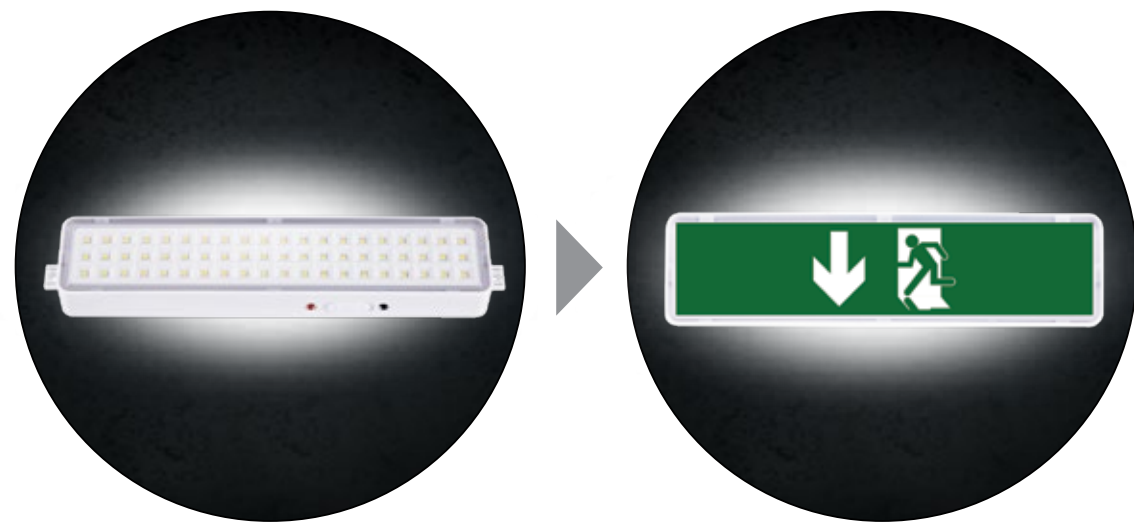

• Χρόνος Φόρτισης Μπαταρίας: 20-24h • Battery Charging Time: 20-24h  
• Χρόνος Αποφόρτισης Μπαταρίας: 2-3h • Battery Discharge Time: 2-3h

• Lumen ανα Επίπεδο Λειτουργίας:  
Χαμηλό: 150 lm / Υψηλό: 300 lm  
• Lumen per Function Level:  
Low: 150 lm / High: 300 lm

220-240V 50-60Hz IP20 Li-ion 1500mA 60CHIPS FUNCTION INDICATOR 0°C ~ +40°C OPERATING TEMP. 0.230

BARCODE	CODE	WATT	KELVIN	LUMEN/WATT	CONNECTION	mm	mm	mm	PACKING	PRICE (€)
5207227075551	145-28001	4W	6000K-7500K	75 lm/Watt	ΦΙΣ / PLUG	250	55	28	1/40	15.85



COLOR Box PACKING



• Χρόνος Φόρτισης Μπαταρίας: 20-24h  
• Battery Charging Time: 20-24h  
• Χρόνος Αποφόρτισης Μπαταρίας: 2-3h  
• Battery Discharge Time: 2-3h

220-240V 50-60Hz IP65 Li-ion 2200mA 40CHIPS FUNCTION INDICATOR 0°C ~ +40°C OPERATING TEMP. 0.650

BARCODE	CODE	WATT	KELVIN	LUMEN/WATT	TOTAL LUMEN	mm	mm	mm	PACKING	PRICE (€)
5207227075605	145-28110	3W	6000K-7500K	100 lm/Watt	300 lm	355	135	55	1/10	25.80





- ΕΦΕΔΡΙΚΟΣ ΦΩΤΙΣΜΟΣ ΧΩΝΕΥΤΟΣ
- EMERGENCY LIGHT RECESSED
- LED

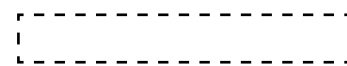

290x45mm

COLOR  
Box  
PACKING



• Χρόνος Φόρτισης Μπαταρίας: 24-48h • Battery Charging Time: 24-48h

• Χρόνος Αποφόρτισης Μπαταρίας: 2-3h • Battery Discharge Time: 2-3h

• Διαστάσεις Κοπής: 290x45mm • Cut Dimensions: 290x45mm

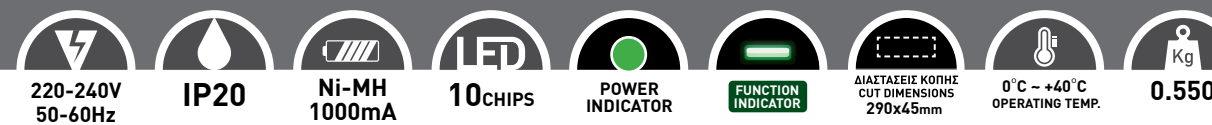

BARCODE	CODE	WATT	KELVIN	LUMEN/WATT	TOTAL LUMEN	mm	mm	mm	PACKING	PRICE (€)
5207227075629	145-28500	2W	6000K-7500K	30 lm/Watt	60 lm	320	180	70	1/10	21.65

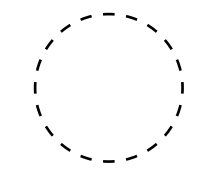

115mm

COLOR  
Box  
PACKING



• Χρόνος Φόρτισης Μπαταρίας: 12-15h • Battery Charging Time: 12-15h

• Χρόνος Αποφόρτισης Μπαταρίας: 2h • Battery Discharge Time: 2h

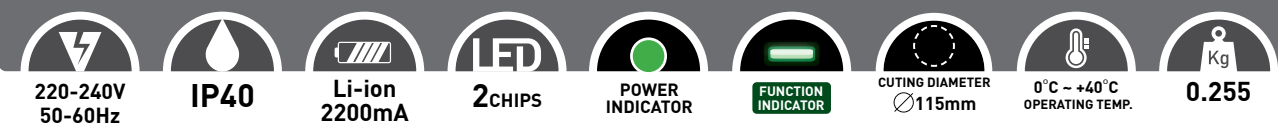

BARCODE	CODE	WATT	KELVIN	LUMEN/WATT	TOTAL LUMEN	mm	mm	mm	PACKING	PRICE (€)	
5207227075636	145-28510	4W	6000K-7500K	45 lm/Watt	180 lm	130	40	130	115	1/10	42.85



- ΕΦΕΔΡΙΚΟΣ ΦΩΤΙΣΜΟΣ
- EMERGENCY LIGHT
- LED



COLOR  
Box  
PACKING



• Χρόνος Φόρτισης Μπαταρίας: 24-48h • Battery Charging Time: 24-48h

• Χρόνος Αποφόρτισης Μπαταρίας: 2-3h • Battery Discharge Time: 2-3h



BARCODE	CODE	WATT	KELVIN	CONNECTION	LUMEN/WATT	TOTAL LUMEN	mm	mm	mm	PACKING	PRICE (€)
5207227075612	145-28400	2W	6000K-7500K	WIRE	30 lm/Watt	60 lm	360	212	32	1/20	26.40



• Lumen ανα Επίπεδο Λειτουργίας:  
Χαμηλό: 150 lm / Υψηλό: 300 lm

• Lumen per Function Level:  
Low: 150 lm / High: 300 lm

COLOR  
Box  
PACKING



• Χρόνος Φόρτισης Μπαταρίας: 20-24h • Battery Charging Time: 20-24h

• Χρόνος Αποφόρτισης Μπαταρίας: 2-3h • Battery Discharge Time: 2-3h



BARCODE	CODE	WATT	KELVIN	LUMEN/WATT	CONNECTION	mm	mm	mm	PACKING	PRICE (€)
5207227075643	145-28600	4W	6000K - 7500K	75 lm/Watt	ΦΙΣ / PLUG	275	260	71	1/5	46.55

• ΠΛΑΦΟΝΙΕΡΑ ΟΡΟΦΗΣ LED ΜΕ ΑΝΙΧΝΕΥΤΗ ΚΙΝΗΣΗΣ ΚΑΙ ΕΦΕΔΡΙΚΟ ΦΩΤΙΣΜΟ  
• LED CEILING LIGHT WITH MOVEMENT SENSOR AND EMERGENCY LIGHT

ΥΛΙΚΟ ΚΑΤΑΣΚΕΥΗΣ / PRODUCTION MATERIAL: **PLASTIC (UV PROOF)**



- Απόσταση Ανίχνευσης: Τοίχος: max 15m / Οροφή: 2 - 8m  
• Detection Distance: Wall: max 15m / Ceiling: 2 - 8m
- Χρόνος Φόρτισης Μπαταρίας: 7 - 10 Ημέρες  
• Battery Charging Time: 7 - 10 Days
- Χρόνος Αποφόρτισης Μπαταρίας: 5h  
• Battery Discharge Time: 5h
- Χρόνος Καθυστέρησης: min:3sec / max:12min  
• Delay Time: min: 3sec / max:12min
- Λειτουργία Έκτακτης Ανάγκης: 1,2W DC / 6Led / 80lm  
• Emergency Load: 1.2W DC / 6Led / 80lm

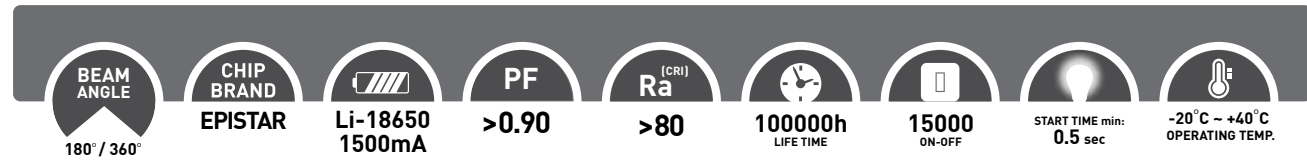
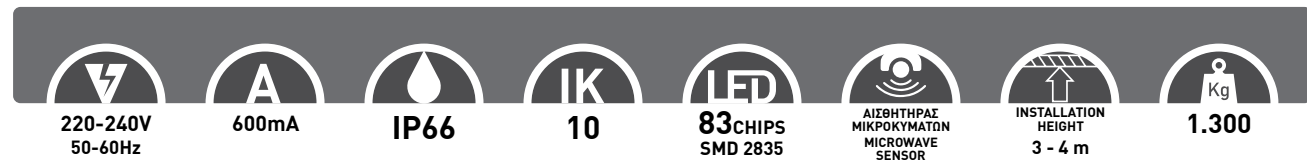

BARCODE	CODE	WATT	DRIVER	KELVIN	LUMEN	mm	mm	PACKING	PRICE (€)
5206139080905	145-55302	16W	(included)	4000K	1200	87	300	1/5	43.20



- Απόσταση Ανίχνευσης: Τοίχος: max 15m / Οροφή: 2 - 8m  
• Detection Distance: Wall: max 15m / Ceiling: 2 - 8m
- Χρόνος Φόρτισης Μπαταρίας: 7 - 10 Ημέρες  
• Battery Charging Time: 7 - 10 Days
- Χρόνος Αποφόρτισης Μπαταρίας: 5h  
• Battery Discharge Time: 5h
- Χρόνος Καθυστέρησης: min:3sec / max:12min  
• Delay Time: min: 3sec / max:12min
- Λειτουργία Έκτακτης Ανάγκης: 1,2W DC / 6Led / 80lm  
• Emergency Load: 1.2W DC / 6Led / 80lm

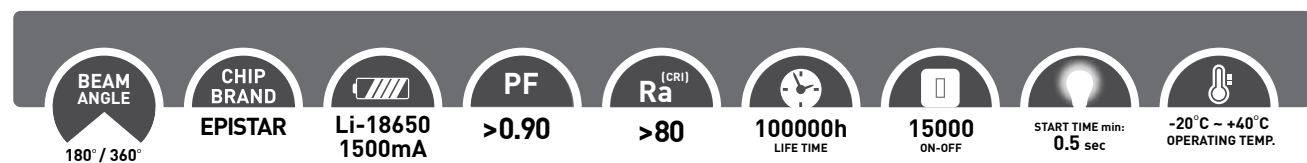
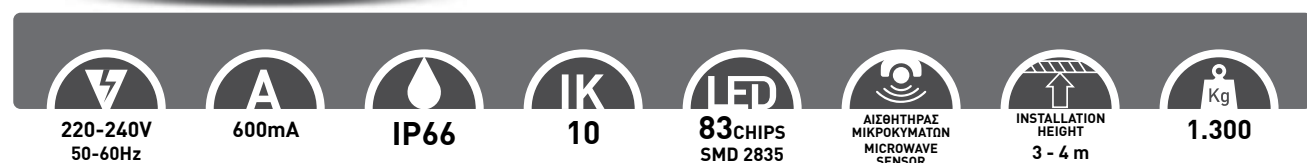

BARCODE	CODE	WATT	DRIVER	KELVIN	LUMEN	mm	mm	PACKING	PRICE (€)
5207227021213	145-55306	16W	(included)	3000K	1200	87	300	1/5	25.15

• ΠΛΑΦΟΝΙΕΡΑ LED ΤΟΙΧΟΥ ΜΕ ΑΝΙΧΝΕΥΤΗ ΚΙΝΗΣΗΣ ΚΑΙ ΕΦΕΔΡΙΚΟ ΦΩΤΙΣΜΟ  
• LED WALL LIGHT WITH MOVEMENT SENSOR AND EMERGENCY LIGHT

ΥΛΙΚΟ ΚΑΤΑΣΚΕΥΗΣ / PRODUCTION MATERIAL: **PLASTIC (UV PROOF)**



- Απόσταση Ανίχνευσης: Τοίχος: max 9m / Οροφή: 2 - 6m  
• Detection Distance: Wall: max 9m / Ceiling: 2 - 6m
- Χρόνος Φόρτισης Μπαταρίας: 7 - 10 Ημέρες  
• Battery Charging Time: 7 - 10 Days
- Χρόνος Αποφόρτισης Μπαταρίας: 5h  
• Battery Discharge Time: 5h
- Χρόνος Καθυστέρησης: min: 3sec / max: 12min  
• Delay Time: min: 3sec / max: 12min
- Λειτουργία Έκτακτης Ανάγκης: 1,2W DC / 6Led / 65lm  
• Emergency Load: 1.2W DC / 6Led / 65lm

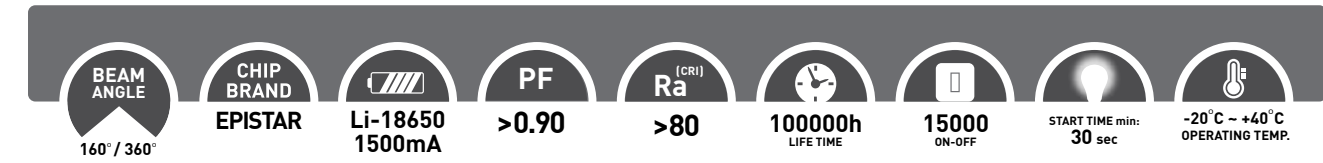

BARCODE	CODE	WATT	DRIVER	KELVIN	LUMEN	mm	mm	PACKING	PRICE (€)
5206139080929	145-55303	15W	(included)	4000K	1250	49	250	1/10	44.55



- Ανιχνευτές Καπνού / Ανιχνευτές Κίνησης / Φωτοκύτταρα  
Ηλεκτρικά Κουδούνια / Θερμοστάτες
- Smoke Alarms / Movement Detectors / Photocell Switches  
Doorbells / Thermostats

**EUROLAMP<sup>®</sup>**  
Electrical Equipment

Discover our Collection ►



- ΑΝΙΧΝΕΥΤΗΣ ΚΑΠΝΟΥ ΑΥΤΟΝΟΜΟΣ
- SMOKE ALARM AUTONOMIC

- Ρεύμα Τροφοδοσίας: <25mA / Στατικό Ρεύμα: <10mA / Ρεύμα Ειδοποίησης: <12mA
- Current: <25mA / Static Current: <10mA / Alarm Current: <12mA
- Λειτουργεί σε Υγρασία Περιβάλλοντος: <95%
- Working Humidity: <95%
- Συναγερμός Χαμηλής Μπαταρίας: 6,2 - 6,8V / Συναγερμός Χαμηλής Τάσης: 5,5-6,2V
- Low Battery Alarm: 6.2 - 6.8V / Low Voltage Alarm: 5.5-6.2V

COLOR  
Box  
PACKING



BARCODE	CODE	mm	WEIGHT (Kgr):	PACKING	PRICE (€)
5207227058912	147-02030	40,5 132	0.235	1/50	8.25



- ΑΝΙΧΝΕΥΤΗΣ ΚΙΝΗΣΗΣ
- MOVEMENT DETECTOR

- Ταχύτητα Ανίχνευσης: 0,6-1,5mtr/sec • Detection Speed: 0,6-1,5mtr/sec
- Απόσταση Ανίχνευσης: 12m • Detection Distance: 12m
- Χρόνος Καθυστέρησης: min:10sec max:15min • Delay Time: min:10sec max:15min

COLOR  
Box  
PACKING

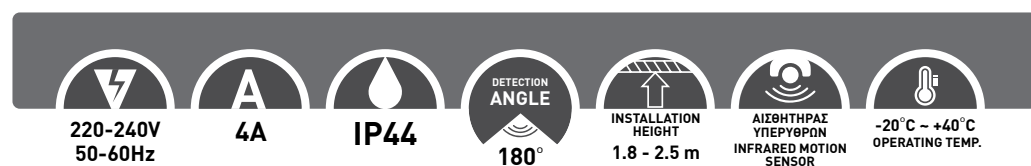

BARCODE	CODE	COLOR	WATT	DIMENSIONS (mm):	WEIGHT (Kgr):	PACKING	PRICE (€)
5206139220004	147-02000	●	800W	55.5 x 68.2 x 80.2	0.097	1/50	8.45
5206139220011	147-02001	○	800W	55.5 x 68.2 x 80.2	0.097	1/50	8.45



- ΑΝΙΧΝΕΥΤΗΣ ΚΙΝΗΣΗΣ
- MOVEMENT DETECTOR

- Ταχύτητα Ανίχνευσης: 0,6-1,5mtr/sec • Detection Speed: 0,6-1,5mtr/sec
- Απόσταση Ανίχνευσης: 12m • Detection Distance: 12m
- Χρόνος Καθυστέρησης: min:10sec max:15min • Delay Time: min:10sec max:15min

COLOR  
Box  
PACKING

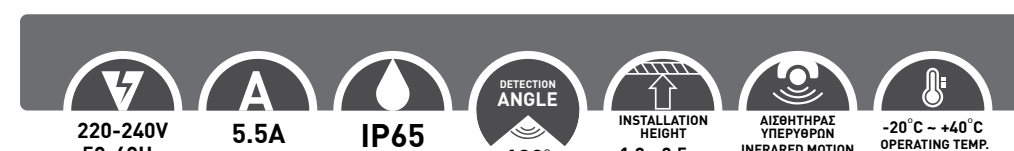

BARCODE	CODE	WATT	DIMENSIONS (mm):	WEIGHT (Kgr):	PACKING	PRICE (€)
5206139038289	147-02003	1200W	119.5 x 51.5 x 80	0.155	1/50	9.15



- ΑΝΙΧΝΕΥΤΗΣ ΚΙΝΗΣΗΣ
- MOVEMENT DETECTOR

- Ταχύτητα Ανίχνευσης: 0,6-1,5mtr/sec • Detection Speed: 0,6-1,5mtr/sec
- Απόσταση Ανίχνευσης: 6m • Detection Distance: 6m
- Χρόνος Καθυστέρησης: min:10sec max:15min • Delay Time: min:10sec max:15min

COLOR  
Box  
PACKING

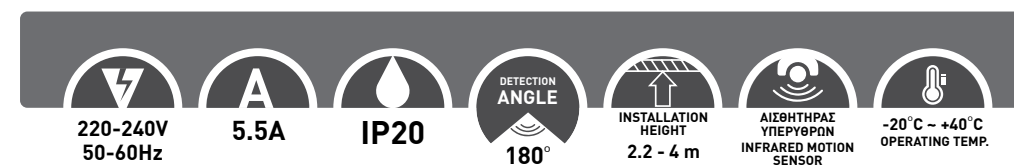

BARCODE	CODE	WATT	mm	WEIGHT (Kgr):	PACKING	PRICE (€)
5206139220042	147-02004	1200W	58.5 115	0.154	1/50	7.85



- ΑΝΙΧΝΕΥΤΗΣ ΚΙΝΗΣΗΣ ΟΡΟΦΗΣ
- CEILING MOVEMENT DETECTOR

• Ταχύτητα Ανίχνευσης: 0,6-1,5mtr/sec • Detection Speed: 0,6-1,5mtr/sec

• Απόσταση Ανίχνευσης: 6m • Detection Distance: 6m

• Χρόνος Καθυστέρησης: min:10sec max:15min • Delay Time: min:10sec max:15min



220-240V 50-60Hz 9A IP20 180° 2,2 - 4 m ΑΙΣΘΗΤΗΡΑΣ ΥΠΕΡΥΘΡΩΝ ΚΙΝΗΣΗΣ -20°C ~ +40°C OPERATING TEMP.



BARCODE	CODE	WATT	mm	WEIGHT (Kgr):	PACKING	PRICE (€)
5206139038395	147-02009	2000W	24.3 115	0.101	1/50	9.35



- ΑΝΙΧΝΕΥΤΗΣ ΠΑΡΟΥΣΙΑΣ ΕΙΩΤΕΡΙΚΟΣ SLIM
- PRESENCE SENSOR SURFACE SLIM

• Ταχύτητα Ανίχνευσης: 0,6-1,5mtr/sec • Detection Speed: 0,6-1,5mtr/sec

• Απόσταση Ανίχνευσης: 2-20m • Detection Distance: 2-20m

• Χρόνος Καθυστέρησης: min:10sec / max: 10min • Delay Time: min:10sec / max: 10min

• Φωτεινότητα Περιβάλλοντος: 10Lux - 2000Lux (Ρυθμιζόμενο)

• Ambient Light: 10Lux - 2000Lux (Adjustable)

COLOR Box PACKING



220-240V 50-60Hz 10A IP20 360° 2.2 - 6 m ΑΙΣΘΗΤΗΡΑΣ ΥΠΕΡΥΘΡΩΝ ΠΑΡΟΥΣΙΑΣ -20°C ~ +40°C OPERATING TEMP.



BARCODE	CODE	POWER	mm	WEIGHT (Kgr):	PACKING	PRICE (€)
5207227058899	147-02016	max 150W / LED	50 120	0.160	1/50	14.65



- ΑΝΙΧΝΕΥΤΗΣ ΚΙΝΗΣΗΣ ΧΩΝΕΥΤΟΣ
- MOVEMENT DETECTOR RECESSED



• Ταχύτητα Ανίχνευσης: 0,6-1,5mtr/sec • Detection Speed: 0,6-1,5mtr/sec

• Απόσταση Ανίχνευσης: 6m • Detection Distance: 6m

• Χρόνος Καθυστέρησης: min:10sec max:15min • Delay Time: min:10sec max:15min



220-240V 50-60Hz 5.5A IP20 180° 2.2 - 4 m ΑΙΣΘΗΤΗΡΑΣ ΥΠΕΡΥΘΡΩΝ ΚΙΝΗΣΗΣ -20°C ~ +40°C OPERATING TEMP.



BARCODE	CODE	WATT	mm	WEIGHT (Kgr):	PACKING	PRICE (€)
5206139038456	147-02007	1200W	75.6 76	0.091	1/50	7.65



- ΑΝΙΧΝΕΥΤΗΣ ΠΑΡΟΥΣΙΑΣ ΧΩΝΕΥΤΟΣ
- PRESENCE SENSOR RECESSED



• Ταχύτητα Ανίχνευσης: 0,6-1,5mtr/sec • Detection Speed: 0,6-1,5mtr/sec

• Απόσταση Ανίχνευσης: 2-20m • Detection Distance: 2-20m

• Χρόνος Καθυστέρησης: min: 10sec / max: 7min • Delay Time: min: 10sec / max: 7min

• Φωτεινότητα Περιβάλλοντος: 10Lux - 2000Lux (Ρυθμιζόμενο)

• Ambient Light: 10Lux - 2000Lux (Adjustable)

COLOR Box PACKING



220-240V 50-60Hz 10A IP20 360° 2.2 - 6 m 76mm ΑΙΣΘΗΤΗΡΑΣ ΥΠΕΡΥΘΡΩΝ ΠΑΡΟΥΣΙΑΣ -20°C ~ +40°C OPERATING TEMP.

BARCODE	CODE	POWER	mm	WEIGHT (Kgr):	PACKING	PRICE (€)
5207227058905	147-02017	max 150W / LED	90 110	0.150	1/50	13.95

- ΦΩΤΟΚΥΤΤΑΡΟ / ΦΩΤΟΔΙΑΚΟΠΤΗΣ ΜΕΡΑΣ-ΝΥΧΤΑΣ
- PHOTOCELL SWITCH DAY AND NIGHT



max. 300W led



COLOR  
Box  
PACKING



BARCODE	CODE	WATT	CONNECTION	DIMENSIONS (mm):	WEIGHT (kgr):	PACKING	PRICE (€)
5206139038487	147-02006	1200	WIRE	44.1 x 46 x 35.5	0.055	1/100	2.95

- ΦΩΤΟΚΥΤΤΑΡΟ / ΦΩΤΟΔΙΑΚΟΠΤΗΣ ΜΕΡΑΣ-ΝΥΧΤΑΣ
- PHOTOCELL SWITCH DAY AND NIGHT



max. 1000W led

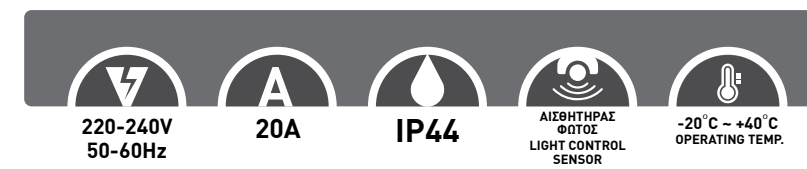

COLOR  
Box  
PACKING



BARCODE	CODE	WATT	CONNECTION	DIMENSIONS (mm):	WEIGHT (kgr):	PACKING	PRICE (€)
5206139038524	147-02008	1200	WIRE	82 x 108	0.115	1/50	7.75

- ΦΩΤΟΚΥΤΤΑΡΟ / ΦΩΤΟΔΙΑΚΟΠΤΗΣ ΜΕΡΑΣ-ΝΥΧΤΑΣ
- PHOTOCELL SWITCH DAY AND NIGHT



max. 500W led



COLOR  
Box  
PACKING



BARCODE	CODE	WATT	CONNECTION	DIMENSIONS (mm):	WEIGHT (kgr):	PACKING	PRICE (€)
5206139220028	147-02002	1200	WIRE	63 x 76.7	0.100	1/100	4.45

- ΦΩΤΟΚΥΤΤΑΡΟ / ΦΩΤΟΔΙΑΚΟΠΤΗΣ ΜΕΡΑΣ-ΝΥΧΤΑΣ
- PHOTOCELL SWITCH DAY AND NIGHT



max. 72W led (12V)

max. 144W led (24V)

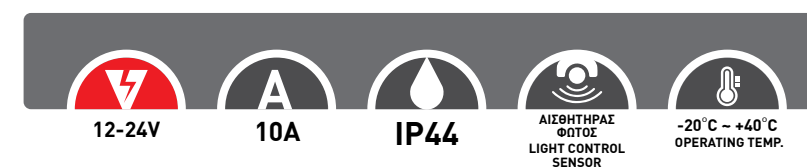

COLOR  
Box  
PACKING



BARCODE	CODE	WATT	CONNECTION	DIMENSIONS (mm):	WEIGHT (kgr):	PACKING	PRICE (€)
5207227002526	147-02018	1200	WIRE	82 x 108	0.115	1/50	5.80



- ΚΟΥΔΟΥΝΙ ΕΝΟΣ ΗΧΟΥ
- ONE SOUND DOORBELL  
"DING DONG"

**EUROLAMP®**  
Electrical Equipment



BARCODE	CODE	DIMENSIONS (mm):	WEIGHT (Kgr):	PACKING	PRICE (€)
5207227032097	147-32000	105 x 170 x 49	0.360	1/12/24	11.65



- ΚΟΥΔΟΥΝΙ ΕΝΟΣ ΗΧΟΥ
- ONE SOUND DOORBELL  
"DING DONG"

**EUROLAMP®**  
Electrical Equipment



BARCODE	CODE	DIMENSIONS (mm):	WEIGHT (Kgr):	PACKING	PRICE (€)
5207227032127	147-32001	105 x 170 x 49	0.650	1/12/24	16.55



- ΚΟΥΔΟΥΝΙ ΑΣΥΡΜΑΤΟ ΜΠΑΤΑΡΙΑΣ
- DOORBELL WIRELESS BATTERY

**EUROLAMP®**  
Electrical Equipment

Double  
Blister  
PACKING



BELL					BUTTON				BARCODE	CODE	BELL (mm):	BUTTON (mm):	WEIGHT (Kgr):	PACKING	PRICE (€)
									5207227032158	147-32020	109 x 155 x 46	39 x 86 x 19	0.193	1/10/40	16.35



- ΚΟΥΔΟΥΝΙ ΑΣΥΡΜΑΤΟ ΠΡΙΖΑΣ
- DOORBELL WIRELESS SOCKET

**EUROLAMP®**  
Electrical Equipment

Double  
Blister  
PACKING



BELL				BUTTON				BARCODE	CODE	BELL (mm):	BUTTON (mm):	WEIGHT (Kgr):	PACKING	PRICE (€)
								5207227032165	147-32021	60 x 98 x 49	32 x 82 x 23	0.100	1/25/50	17.45



- ΘΕΡΜΟΣΤΑΤΗΣ ΜΗΧΑΝΙΚΟΣ
- THERMOSTAT MECHANICAL

COLOR  
Box  
PACKING



220-250V 50-60Hz	4A	IP20	ON-OFF SWITCH	FIREPROOF MATERIAL UL 94 V-0	TEMPERATURE RANGE OF THERMOSTAT 0°C - 40°C	-10°C - +50°C OPERATING TEMP.			
BARCODE	CODE	POWER	CONTACT	DIMENSIONS (mm):		WEIGHT (Kgr):	PACKING	PRICE (€)	
5207227058721	147-44001	2KW	NO & NC	75	75	30	0.080	1/100	11.25



- ΘΕΡΜΟΣΤΑΤΗΣ ΧΩΡΟΥ ΗΜΕΡΗΣΙΟΣ ΗΛΕΚΤΡΟΝΙΚΟΣ
- DAILY INTERNAL DIGITAL THERMOSTAT

Double  
Blister  
PACKING



230V 50-60Hz	16A RESISTIVITY 5A INDUCTIVE	IP20	ON-OFF SWITCH	TEMPERATURE RANGE OF THERMOSTAT 5°C - 30°C	-10°C - +40°C OPERATING TEMP.				
BARCODE	CODE	POWER	CONTACT	DIMENSIONS (mm):		WEIGHT (Kgr):	PACKING	PRICE (€)	
5207227058752	147-44010	3680W	NO	86	86	32.7	0.157	1/10/60	25.55



- ΘΕΡΜΟΣΤΑΤΗΣ ΧΩΡΟΥ ΕΒΔΟΜΑΔΙΑΙΟΣ 24 ΩΡΩΝ ΗΛΕΚΤΡΟΝΙΚΟΣ
- WEEKLY 24 HOURS INTERNAL DIGITAL THERMOSTAT

Double  
Blister  
PACKING



230V 50-60Hz	6A	IP20	ON-OFF SWITCH	TEMPERATURE RANGE OF THERMOSTAT 5°C - 30°C	-10°C - +40°C OPERATING TEMP.				
BARCODE	CODE	POWER	CONTACT	DIMENSIONS (mm):		WEIGHT (Kgr):	PACKING	PRICE (€)	
5207227058783	147-44011	1380W	NO	125	83	30	0.157	1/10/60	37.60

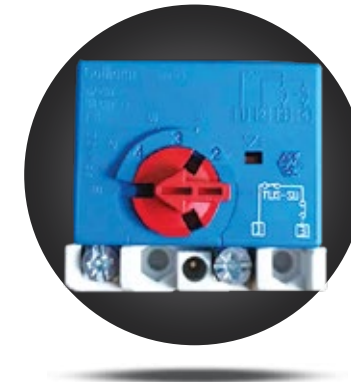

- ΘΕΡΜΟΣΤΑΤΗΣ ΘΕΡΜΟΣΙΦΩΝΟΥ
- WATER HEATER THERMOSTAT
- 2 ΕΠΑΦΩΝ • 2 CONTACTS

PlasticBag  
with Sticker  
PACKING



220-240V	IP20	-20°C - +60°C OPERATING TEMP.	TEMPERATURE RANGE OF THERMOSTAT 30°C - 80°C	OVER HEAT SAFE					
BARCODE	CODE	CONTACT	DIMENSIONS (mm):		WEIGHT (Kgr):	PACKING	PRICE (€)		
5207227059902	147-44500	NO + NC	50	40	30	0.102	1/100	6.95	

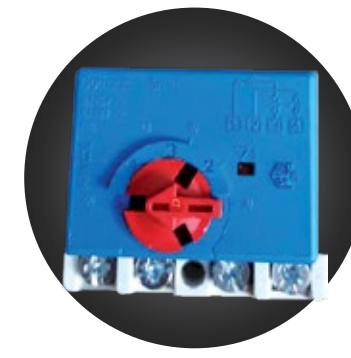

- ΘΕΡΜΟΣΤΑΤΗΣ ΘΕΡΜΟΣΙΦΩΝΟΥ
- WATER HEATER THERMOSTAT
- 4 ΕΠΑΦΩΝ • 4 CONTACTS

PlasticBag  
with Sticker  
PACKING



220-240V	IP20	-20°C - +60°C OPERATING TEMP.	TEMPERATURE RANGE OF THERMOSTAT 30°C - 80°C	OVER HEAT SAFE					
BARCODE	CODE	CONTACT	DIMENSIONS (mm):		WEIGHT (Kgr):	PACKING	PRICE (€)		
5207227059926	147-44501	2NO + 2NC	50	40	30	0.110	1/100	7.85	

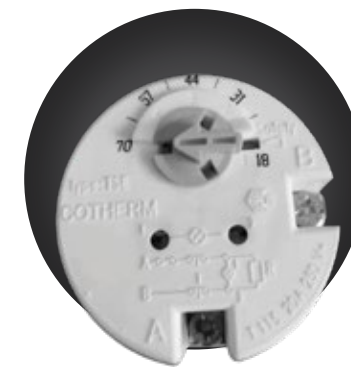

- ΘΕΡΜΟΣΤΑΤΗΣ ΘΕΡΜΟΣΙΦΩΝΟΥ
- WATER HEATER THERMOSTAT
- ΚΟΥΜΠΩΤΟΣ • BUTTONED

PlasticBag  
with Sticker  
PACKING



220-240V	IP20	-20°C - +60°C OPERATING TEMP.	TEMPERATURE RANGE OF THERMOSTAT 18°C - 70°C	OVER HEAT SAFE					
BARCODE	CODE	CONTACT	DIMENSIONS (mm):		WEIGHT (Kgr):	PACKING	PRICE (€)		
5207227059940	147-44502	NO + NC	28	50		0.094	1/100	7.95	





• Εξαεριστήρας Λουτρού / Σεσουάρ Ξενοδοχείου /  
Στεγνωτήρας Χεριών

• Bath Ventilation Fan / Hair Dryer for Hotels / Hand Dryer

**EUROLAMP<sup>®</sup>**

Pioneers in New Technology !

Discover our Collection ►

- ΕΞΑΕΡΙΣΤΗΡΑΣ ΛΟΥΤΡΟΥ
- BATH VENTILATION FAN



147-33210

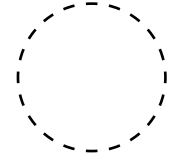

∅ 110mm

147-33211

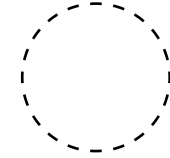

∅ 130mm

COLOR  
Box  
PACKING

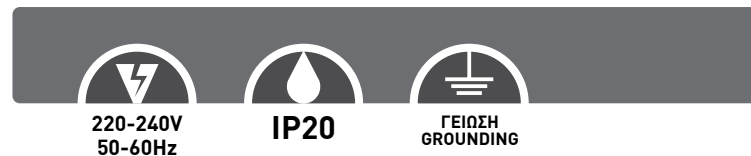

BARCODE	CODE	WATT	max. AIR FLOW	mm	mm	mm	mm	WEIGHT (kg):	PACKING	PRICE (€)
5207227014123	147-33210	15W	100 m <sup>3</sup> /h	158	158	85	100	0.536	1/30	11.25
5207227014130	147-33211	20W	120 m <sup>3</sup> /h	175	175	85	120	0.583	1/24	11.95



147-33240

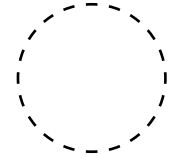

∅ 110mm

147-33241

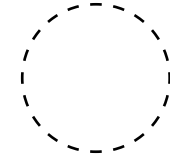

∅ 130mm

COLOR  
Box  
PACKING



BARCODE	CODE	WATT	max. AIR FLOW	mm	mm	mm	mm	WEIGHT (kg):	PACKING	PRICE (€)
5207227069314	147-33240	12W	130 m <sup>3</sup> /h	157	157	100	0.698	0.698	1/20	16.55
5207227069338	147-33241	16W	240 m <sup>3</sup> /h	157	157	120	0.637	0.637	1/20	17.95

- ΕΞΑΕΡΙΣΤΗΡΑΣ ΛΟΥΤΡΟΥ  
**ΜΕ ΧΡΟΝΟΔΙΑΚΟΠΤΗ**
- BATH VENTILATION FAN  
**WITH TIMER**

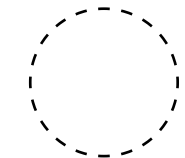

∅ 110mm

COLOR  
Box  
PACKING



- Διαθέτει Αντεπιστροφή Αέρα • Damper NON-Return Air
- Ο χρονοδιακόπτης εξασφαλίζει την λειτουργία του εξαεριστήρα, μετά το κλείσιμο του διακόπτη & ρυθμίζεται από 30sec - 30min
- The timer ensures the ventilator operation after the switch is closed & it is adjusted from 30sec - 30min



BARCODE	CODE	WATT	max. AIR FLOW	mm	mm	mm	mm	WEIGHT (kg):	PACKING	PRICE (€)
5207227069352	147-33242	12W	130 m <sup>3</sup> /h	157	157	100	0.698	0.698	1/20	25.35

- ΕΞΑΕΡΙΣΤΗΡΑΣ ΛΟΥΤΡΟΥ **ΜΕ ΛΕΠΤΗ ΠΡΟΣΩΠΗ**
- BATH VENTILATION FAN  
**ULTRA THIN PANEL**

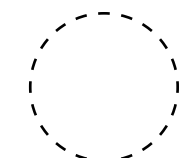

∅ 110mm

COLOR  
Box  
PACKING



- Διαθέτει Αντεπιστροφή Αέρα • Damper NON-Return Air
- 

BARCODE	CODE	WATT	max. AIR FLOW	mm	mm	mm	mm	WEIGHT (kg):	PACKING	PRICE (€)
5207227069277	147-33220	12W	130 m <sup>3</sup> /h	150	150	100	0.642	0.642	1/20	18.45



- ΕΞΑΕΡΙΣΤΗΡΑΣ ΛΟΥΤΡΟΥ
- BATH VENTILATION FAN
- **ULTRA LUX PANEL**



ΔΙΑΣΤΑΣΕΙΣ ΚΟΠΗΣ:  
CUTTING DIMENSIONS:

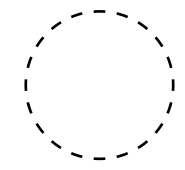

∅ 110mm

• Διαθέτει Αντεπιστροφή Αέρα • Damper NON-Return Air



BARCODE	CODE	WATT	max. AIR FLOW	mm	mm	mm	WEIGHT (Kgr):	PACKING	PRICE (€)
5207227069291	147-33230	12W	95 m³/h	150	150	100	0.696	1/24	19.95



- ΕΞΑΕΡΙΣΤΗΡΑΣ ΛΟΥΤΡΟΥ **ΣΩΛΗΝΩΤΟΣ**
- BATH VENTILATION FAN **TUBULAR**



ΔΙΑΣΤΑΣΕΙΣ ΚΟΠΗΣ:  
CUTTING DIMENSIONS:

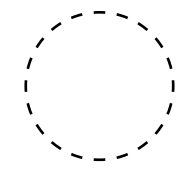

∅ 110mm

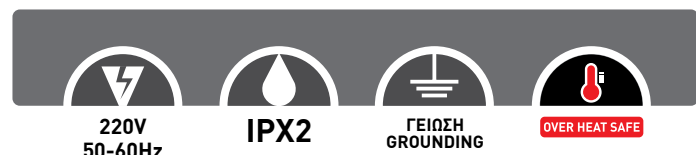

BARCODE	CODE	WATT	max. AIR FLOW	mm	WEIGHT (Kgr):	PACKING	PRICE (€)
5207227069376	147-33250	12W	130 m³/h	100	0.446	1/40	15.85

- ΣΕΣΟΥΑΡ ΞΕΝΟΔΟΧΕΙΟΥ **ΜΕ ΠΡΙΖΑ**
- HAIR DRYER FOR HOTELS
- **WITH SOCKET**



WHITE  
Box  
PACKING



• Ταχύτητα Αέρα: 13m/sec • Air Speed: 13m/sec  
• Μήκος Καλωδίου: 300mm • Cable Length: 300mm



BARCODE	CODE	WATT	mm	mm	mm	WEIGHT (Kgr):	PACKING	PRICE (€)
5207227012624	147-45000	1200W	185	230	95	0.806	1/12	21.85

- ΣΕΣΟΥΑΡ ΞΕΝΟΔΟΧΕΙΟΥ **ΜΕ ΠΡΙΖΑ**
- HAIR DRYER FOR HOTELS
- **WITH SOCKET**



WHITE  
Box  
PACKING



• Ταχύτητα Αέρα: 13m/sec • Air Speed: 13m/sec

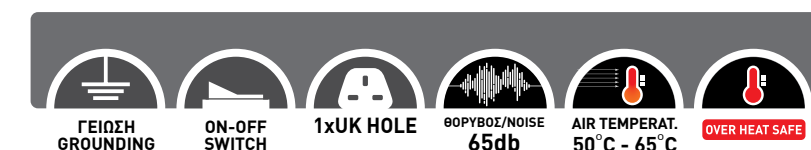

BARCODE	CODE	WATT	mm	mm	mm	WEIGHT (Kgr):	PACKING	PRICE (€)
5207227069413	147-45001	1200W	185	230	95	0.806	1/12	26.85

- ΣΕΣΟΥΑΡ ΞΕΝΟΔΟΧΕΙΟΥ ΜΕ ΠΡΙΖΑ
- HAIR DRYER FOR HOTELS WITH SOCKET



WHITE  
Box  
PACKING



- Ταχύτητα Αέρα: 18m/sec • Air Speed: 18m/sec
- Μήκος Καλωδίου: 300mm • Cable Length: 300mm



220-240V 50-60Hz 7.25A IPX1 3 x 1mm 80 cm



ΓΕΙΩΣΗ GROUNDING ON-OFF SWITCH 1xUK HOLE ΘΟΡΥΒΟΣ/NOISE 65db AIR TEMPERAT. 65°C OVER HEAT SAFE

BARCODE	CODE	WATT	mm	mm	mm	WEIGHT (kg):	PACKING	PRICE (€)
5207227069390	147-45010	1500W	260	250	140	0.922	1/12	37.25

- ΣΤΕΓΝΩΤΗΡΑΣ ΧΕΡΙΩΝ ΠΛΑΣΤΙΚΟΣ  
**ΜΕ ΧΡΟΝΟΔΙΑΚΟΠΤΗ**
- HAND DRYER PLASTIC  
**WITH TIMER**



WHITE  
Box  
PACKING



- Απόσταση Ανίχνευσης: 0,5m • Detection Distance: 0.5m
- Χρόνος Καθυστέρησης: 1sec • Delay Time: 1sec
- Ταχύτητα Αέρα: 20m/sec • Air Speed: 20m/sec



220-240V 50-60Hz 8.20A IPX1 ΓΕΙΩΣΗ GROUNDING



CLASS II ΧΡΟΝΟΔΙΑΚΟΠΤΗΣ TIMER ΘΟΡΥΒΟΣ/NOISE 60db AIR TEMPERAT. 40°C - 65°C

BARCODE	CODE	WATT	mm	mm	mm	WEIGHT (kg):	PACKING	PRICE (€)
5207227069437	147-45100	1800W	230	240	240	2.159	1/8	57.60



• Μονωτικές Ταινίες / Δοκιμαστικά Κατσαβίδια / Ψηφιακά Πολύμετρα / Μαγνητικά Ballast

• PVC Electrical Insulating Tapes / Screwdriver Tester / Multimeter Digital / Magnetic Ballast

**EUROLAMP<sup>®</sup>**  
Electrical Equipment

Discover our Collection ►



• ΜΟΝΩΤΙΚΕΣ ΤΑΙΝΙΕΣ PVC  
• PVC ELECTRICAL INSULATING TAPES

Shrink Film PACKING

PRODUCTION MATERIAL: PVC / FLAME RETARDANT  
ΥΛΙΚΟ ΚΑΤΑΣΚΕΥΗΣ: PVC / ΕΠΙΒΡΑΔΥΝΤΙΚΟ ΦΛΟΓΑΣ

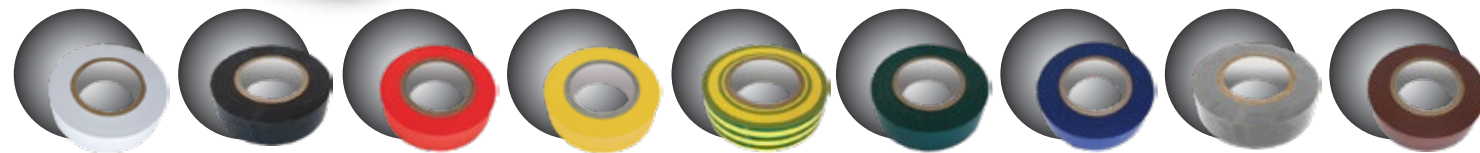
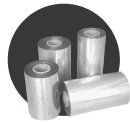

BARCODE	CODE	COLOR	LENGTH m	WIDTH mm	THICKNESS $\frac{1}{2}$ mm	PACKING	PRICE (€)
5206139202000	147-34000	○	20m	19	0.125	1/10/300	0.73
5206139202017	147-34001	●	20m	19	0.125	1/10/300	0.73
5206139202024	147-34002	●	20m	19	0.125	1/10/300	0.73
5206139202031	147-34003	●	20m	19	0.125	1/10/300	0.73
5206139202048	147-34004	◎	20m	19	0.125	1/10/300	0.73
5206139202055	147-34005	●	20m	19	0.125	1/10/300	0.73
5206139202062	147-34006	●	20m	19	0.125	1/10/300	0.73
5206139202079	147-34007	●	20m	19	0.125	1/10/300	0.73
5206139202086	147-34008	●	20m	19	0.125	1/10/300	0.73

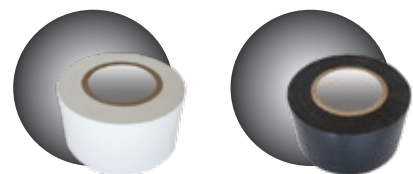

BARCODE	CODE	COLOR	LENGTH m	WIDTH mm	THICKNESS $\frac{1}{2}$ mm	PACKING	PRICE (€)
5206139202109	147-34010	○	20m	38	0.125	1/5/150	1.58
5206139202116	147-34011	●	20m	38	0.125	1/5/150	1.58
5207227080081	147-34030	○	30m	48	0.188	1/3/90	3.42
5207227080098	147-34031	●	30m	48	0.188	1/3/90	3.42

• ΜΟΝΩΤΙΚΕΣ ΤΑΙΝΙΕΣ ΑΥΤΟΒΟΥΛΚΑΝΙΖΟΜΕΝΕΣ  
• PVC TAPES

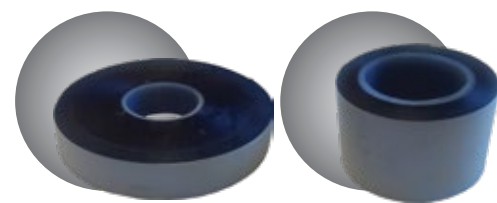

PRODUCTION MATERIAL: PVC  
ΥΛΙΚΟ ΚΑΤΑΣΚΕΥΗΣ: PVC



PlasticBag PACKING



BARCODE	CODE	COLOR	LENGTH m	WIDTH mm	THICKNESS $\frac{1}{2}$ mm	PACKING	PRICE (€)
5206139072948	147-34020	●	9m	19	0.90	1/48	3.28
5206139072986	147-34021	●	1.5m	38	0.90	1/48	1.18

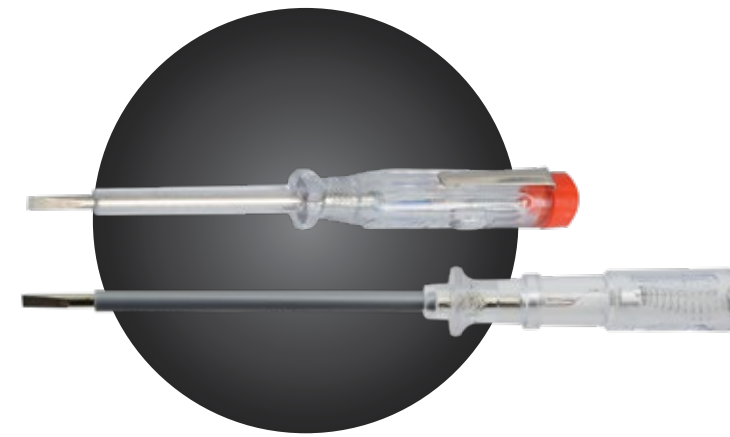

• ΚΑΤΣΑΒΙΔΙ ΔΟΚΙΜΑΣΤΙΚΟ  
• SCREWDRIVER TESTER

PRODUCTION MATERIAL: AS  
ΥΛΙΚΟ ΚΑΤΑΣΚΕΥΗΣ: AS

Bulk PACKING

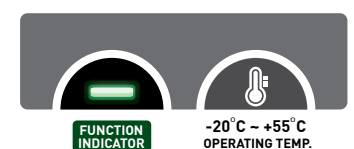

BARCODE	CODE	SUPPLY VOLTAGE	SIZE	mm	mm	WEIGHT (kgr):	PACKING	PRICE (€)
5206139211002	147-18000	100 - 500V / 50-60Hz	SMALL	140	3	0.047	1/20/500	0.70
5206139211019	147-18001	100 - 500V / 50-60Hz	BIG	190	3.5	0.054	1/20/500	1.04

• ΚΑΤΣΑΒΙΔΙ ΔΟΚΙΜΑΣΤΙΚΟ • SCREWDRIVER TESTER

PRODUCTION MATERIAL: AS+ABS  
ΥΛΙΚΟ ΚΑΤΑΣΚΕΥΗΣ: AS+ABS

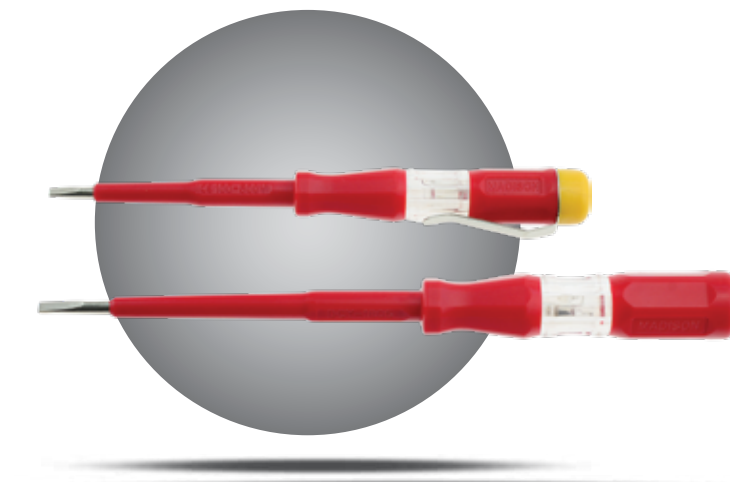

20 PCS / DISPLAY BOX PACKING

**EUROLAMP**<sup>®</sup>  
Electrical Equipment

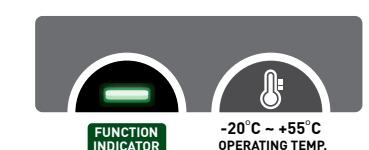

BARCODE	CODE	SUPPLY VOLTAGE	SIZE	mm	mm	WEIGHT (kgr):	PACKING	PRICE (€)
5207227029714	147-18020	100 - 500V / 50-60Hz	SMALL	140	3	0.014	1/20/600	1.64
5207227029745	147-18021	100 - 500V / 50-60Hz	BIG	185	3	0.026	1/20/500	1.84

• ΠΟΛΥΜΕΤΡΟ ΨΗΦΙΑΚΟ • MULTIMETER DIGITAL



- Μήκος Καλωδίου: 300mm
- Cable Length: 300mm
- Εύρος Μέτρησης DC Volt: 2V-20V-200V-500V
- Measurement Range DC Volt: 2V-20V-200V-500V
- Εύρος Μέτρησης AC Volt: 200V-500V
- Measurement Range AC Volt: 200V-500V
- Εύρος Μέτρησης DC A: 5A
- Measurement Range DC A: 5A
- Αντίσταση: 200-2K-20K-200K-2M & Omega
- Resistance: 200-2K-20K-200K-2M & Omega

COLOR  
Box  
PACKING



- 9V DC
- ON-OFF SWITCH
- IP44
- 20°C ~ +50°C OPERATING TEMP.



BARCODE	CODE	DISPLAY	mm	mm	mm	WEIGHT (Kgr):	PACKING	PRICE (€)
5207227059186	147-18500	DIGITAL MONITOR	67	135	33	0.340	1/50	13.75

• ΠΟΛΥΜΕΤΡΟ ΨΗΦΙΑΚΟ ΤΣΕΠΗΣ • MULTIMETER DIGITAL ROCKET



- Μήκος Καλωδίου: 200mm
- Cable Length: 200mm
- Εύρος Μέτρησης DC Volt: 2V-200V-400V
- Measurement Range DC Volt: 2V-200V-400V
- Εύρος Μέτρησης AC Volt: 200V-400V
- Measurement Range AC Volt: 200V-400V
- Εύρος Μέτρησης DC A: 200mA
- Measurement Range DC A: 200mA
- Αντίσταση: 200-2000-20K-200-2000K & Omega
- Resistance: 200-2000-20K-200-2000K & Omega

COLOR  
Box  
PACKING



- 12V DC 23A
- ON-OFF SWITCH
- IP44
- 20°C ~ +50°C OPERATING TEMP.



BARCODE	CODE	DISPLAY	mm	mm	mm	WEIGHT (Kgr):	PACKING	PRICE (€)
5207227059209	147-18501	DIGITAL MONITOR	60	102	24	0.120	1/100	9.15

• ΨΗΦΙΑΚΗ ΑΜΠΕΡΟΤΣΙΜΠΙΔΑ • DIGITAL CLAMP METER



- Μήκος Καλωδίου: 300mm
- Cable Length: 300mm
- Εύρος Μέτρησης DC Volt: 1000V
- Measurement Range DC Volt: 1000V
- Εύρος Μέτρησης AC Volt: 750V
- Measurement Range AC Volt: 750V
- Εύρος Μέτρησης DC A: 200-1000A
- Measurement Range DC A: 200-1000A
- Αντίσταση: 200-20K & Omega
- Resistance: 200-20K & Omega

COLOR  
Box  
PACKING



- 9V DC
- ON-OFF SWITCH
- IP44
- 20°C ~ +50°C OPERATING TEMP.



BARCODE	CODE	DISPLAY	mm	mm	mm	WEIGHT (Kgr):	PACKING	PRICE (€)
5207227059223	147-18502	DIGITAL MONITOR	68	230	37	0.340	1/40	14.85

• ΜΑΓΝΗΤΙΚΟ BALLAST ΥΔΡΑΡΓΥΡΟΥ • MAGNETIC MERCURY BALLAST

• PRODUCTION MATERIAL: **ΜΕΤΑΛΛΟ & ΧΑΛΚΟΣ** • ΥΛΙΚΟ ΚΑΤΑΣΚΕΥΗΣ: **METALLIC & COPPER**



- 230V 50-60Hz
- IP20
- ΓΕΙΩΣΗ GROUNDING
- 25°C ~ +75°C OPERATING TEMP.

PlasticBag  
with Sticker  
PACKING



BARCODE	CODE	POWER (w)	AMPERE	mm	mm	mm	WEIGHT (Kgr):	PACKING	PRICE (€)
5206139332530	147-50253	80	0.80	112	53	69	1.000	1/3	7.45
5206139332554	147-50255	125	1.15	112	53	69	1.100	1/3	10.85
5206139332578	147-50257	250	2.13	145	53	69	1.850	1/3	14.70
5206139332592	147-50259	400	3.25	180	53	69	3.000	1/3	24.35

• ΜΑΓΝΗΤΙΚΟ BALLAST ΝΑΤΡΙΟΥ • MAGNETIC SODIUM BALLAST

• PRODUCTION MATERIAL: **ΜΕΤΑΛΛΟ & ΧΑΛΚΟΣ** • ΥΛΙΚΟ ΚΑΤΑΣΚΕΥΗΣ: **METALLIC & COPPER**

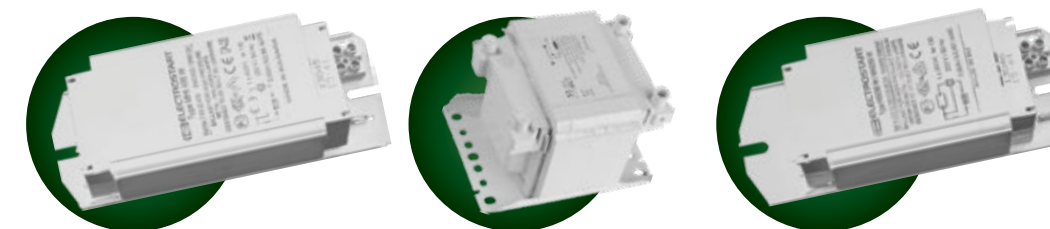

- 230V 50-60Hz
- IP20
- ΓΕΙΩΣΗ GROUNDING
- 25°C ~ +75°C OPERATING TEMP.

PlasticBag  
with Sticker  
PACKING



BARCODE	CODE	POWER (w)	AMPERE	mm	mm	mm	WEIGHT (Kgr):	PACKING	PRICE (€)
5206139332516	147-50251	50	0.76	112	53	69	1.000	1/3	10.45
5206139332523	147-50252	70	1.00	112	53	69	1.150	1/3	10.95
5206139332547	147-50254	100	1.20	112	53	69	1.150	1/3	11.35
5206139332561	147-50256	150	1.80	145	53	69	1.800	1/3	14.70
5206139332585	147-50258	250	3.00	180	53	69	3.000	1/3	24.35
5206139332608	147-50260	400	4.45	148	91	104	4.650	1/2	32.75
5206139332882	147-50261	1000	10.30	248	91	104	11.150	1/1	87.85

• ΜΑΓΝΗΤΙΚΟ BALLAST ΜΕΤΑΛΛΟΥ • MAGNETIC METAL HALIDE BALLAST

• PRODUCTION MATERIAL: **ΜΕΤΑΛΛΟ & ΧΑΛΚΟΣ** • ΥΛΙΚΟ ΚΑΤΑΣΚΕΥΗΣ: **METALLIC & COPPER**

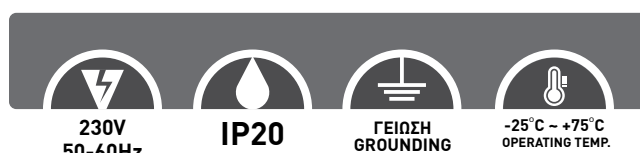

BARCODE	CODE	POWER [w]	AMPERE	mm	mm	mm	WEIGHT [Kgr]:	PACKING	PRICE (€)
5206139005410	147-50263	400	3.50	180	53	69	3.100	1/3	27.15

• ΜΕΤΑΣΧΗΜΑΤΙΣΤΗΣ ΜΑΓΝΗΤΙΚΟΣ ΤΥΠΟΥ BALLAST  
• MAGNETIC TRANSFORMER BALLAST TYPE

• PRODUCTION MATERIAL: **ΜΕΤΑΛΛΟ & ΧΑΛΚΟΣ** • ΥΛΙΚΟ ΚΑΤΑΣΚΕΥΗΣ: **METALLIC & COPPER**

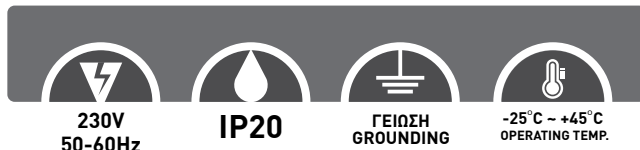
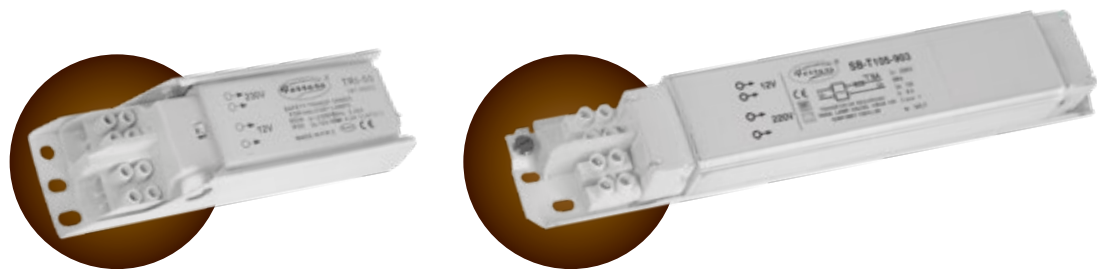

BARCODE	CODE	POWER [w]	AMPERE	mm	mm	mm	WEIGHT [Kgr]:	PACKING	PRICE (€)
5206139330031	147-50003	50	0.50	150	40	40	0.820	1/10	6.75
5206139330048	147-50004	105	0.63	250	40	30	1.300	1/5	11.75

• ΜΕΤΑΣΧΗΜΑΤΙΣΤΗΣ ΗΛΕΚΤΡΟΝΙΚΟΣ  
• ELECTRONIC TRANSFORMER

• ΥΛΙΚΟ ΚΑΤΑΣΚΕΥΗΣ: **ΜΕΤΑΛΛΟ & ΧΑΛΚΟΣ**  
• PRODUCTION MATERIAL: **ΜΕΤΑΛΛΟ & ΧΑΛΚΟΣ**

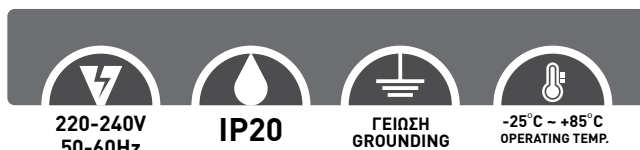

BARCODE	CODE	POWER [w]	AMPERE	mm	mm	mm	WEIGHT [Kgr]:	PACKING	PRICE (€)
5206139009029	147-50005	50	0.30	101	34	25	0.064	1/30	5.35

• ΜΑΓΝΗΤΙΚΟ BALLAST ΦΘΟΡΙΣΜΟΥ • MAGNETIC FLUORESCENT BALLAST

• PRODUCTION MATERIAL: **ΜΕΤΑΛΛΟ & ΧΑΛΚΟΣ** • ΥΛΙΚΟ ΚΑΤΑΣΚΕΥΗΣ: **METALLIC & COPPER**

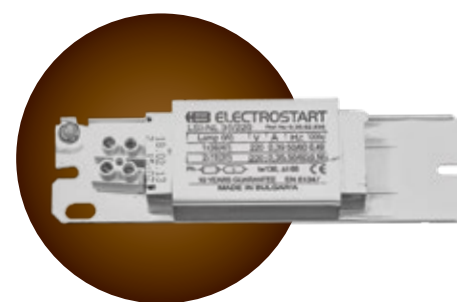

BARCODE	CODE	POWER [w]	AMPERE	mm	mm	mm	WEIGHT [Kgr]:	PACKING	PRICE (€)
5206139005427	147-50012	18	0.37	134	74	61	0.500	1/10	3.42
5206139005434	147-50013	36	0.43	155	41	26	0.500	1/10	3.42
5206139005441	147-50014	58	0.67	155	41	28	0.830	1/10	5.36

• ΕΚΚΙΝΗΤΗΣ ΜΕΤΑΛΛΟΥ ΝΑΤΡΙΟΥ  
• INGIATOR METAL SODIUM

• ΥΛΙΚΟ ΚΑΤΑΣΚΕΥΗΣ: **ΜΕΤΑΛΛΟ & ΧΑΛΚΟΣ**  
• PRODUCTION MATERIAL: **ΜΕΤΑΛΛΟ & ΧΑΛΚΟΣ**

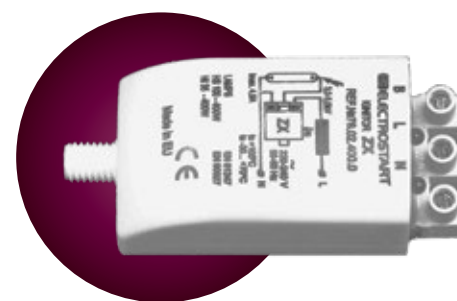

BARCODE	CODE	POWER [w]	AMPERE	mm	mm	mm	WEIGHT [Kgr]:	PACKING	PRICE (€)
5206139005458	147-50015	70-400	4.5	75	34	30	0.115	1/50	5.52
5207227001604	147-50016	600-1000	10.3	95	43	35	0.225	1/40	14.05



BARCODE	CODE	POWER [w]	AMPERE	mm	mm	mm	WEIGHT [Kgr]:	PACKING	PRICE (€)
5206139330406	147-50040	70-400	4.5	75	34	30	0.115	1/50	3.99





**EUROLAMP<sup>®</sup>**  
Electrical Equipment

- Εξωτερικοί Διακόπτες / Πρίζες / Μπουτόν
- External Switches / Sockets / Buttons

Discover our Collection ►

- ΕΞΩΤΕΡΙΚΟΙ ΔΙΑΚΟΠΤΕΣ & ΠΡΙΖΕΣ
- SURFACE SIMPLE SWITCH OUTDOOR

- ΥΛΙΚΟ ΚΑΤΑΣΚΕΥΗΣ: **PLASTIC & COPPER**
- PRODUCTION MATERIAL: **ΠΛΑΣΤΙΚΟ & ΧΑΛΚΟΣ**



	BARCODE	CODE	DESCRIPTION	WATT	mm	mm	mm	PACKING	PRICE (€)
1	5206139105400	147-12240	ΔΙΑΚΟΠΤΗΣ ΕΞΩΤΕΡΙΚΟΣ ΑΠΛΟΣ MINI SURFACE MINI SIMPLE SWITCH OUTDOOR	2400	65	65	30	1/10/200	1.76
2	5206139105417	147-12241	ΔΙΑΚΟΠΤΗΣ ΕΞΩΤΕΡΙΚΟΣ A/R MINI SURFACE MINI A/R SWITCH OUTDOOR	2400	65	65	30	1/10/200	2.22
3	5206139105424	147-12242	ΔΙΑΚΟΠΤΗΣ ΕΞΩΤΕΡΙΚΟΣ K/R MINI SURFACE MINI K/R SWITCH OUTDOOR	2400	65	65	30	1/10/200	2.28

- ΕΞΩΤΕΡΙΚΟΙ ΔΙΑΚΟΠΤΕΣ & ΠΡΙΖΕΣ
- SURFACE SIMPLE SWITCH OUTDOOR

- ΥΛΙΚΟ ΚΑΤΑΣΚΕΥΗΣ: **PLASTIC & COPPER**
- PRODUCTION MATERIAL: **ΠΛΑΣΤΙΚΟ & ΧΑΛΚΟΣ**

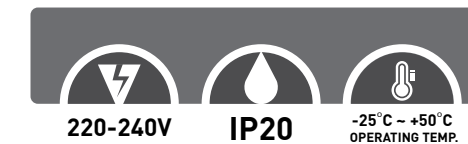

	BARCODE	CODE	DESCRIPTION	mm	mm	mm	PACKING	PRICE (€)
1	5206139106414	147-16241	ΠΡΙΖΑ MINI TV ΤΕΡΜΑΤΙΚΗ SOCKET MINI TV TERMINAL	65	65	30	1/10/200	1.94
2	5206139106421	147-16242	ΠΡΙΖΑ MINI TV & FM ΤΕΡΜΑΤΙΚΗ ΛΕΥΚΗ IP20 SOCKET MINI TV & FM TERMINAL WHITE IP20	65	65	30	1/10/200	2.72
3	5206139106476	147-16247	ΠΡΙΖΑ MINI ΤΗΛΕΦΩΝΟΥ ΔΙΠΛΗ RJ11 ΚΑΙ RJ45 SOCKET MINI PHONE DOUBLE RJ11 AND RJ45	65	65	30	1/10/200	3.42



	BARCODE	CODE	DESCRIPTION	WATT	mm	mm	mm	PACKING	PRICE (€)
1	5206139045904	147-12244	ΜΠΟΥΤΟΝ ΡΟΛΛΩΝ MINI SURFACE MINI SHUTTER CONTROL SWITCH	2400	65	65	30	1/10/200	2.82
2	5206139105455	147-12245	ΜΠΟΥΤΟΝ ΚΟΥΔΟΥΝΙΟΥ MINI SURFACE MINI BELL PUSH-BUTTON OUTDOOR	2400	65	65	30	1/10/200	2.31
3	5206139105462	147-12246	ΜΠΟΥΤΟΝ ΕΞΩΤΕΡΙΚΟΣ ΚΛΙΜΑΚΟΣΤΑΣΙΟΥ-ΛΥΧΝΙΑ MINI SURFACE MINI PUSH-BUTTON WITH INDICATOR OUTDOOR	2400	65	65	30	1/10/200	2.31



	BARCODE	CODE	DESCRIPTION	mm	mm	mm	PACKING	PRICE (€)
1	5206139106438	147-16243	ΠΡΙΖΑ MINI ΤΗΛΕΦΩΝΟΥ ΜΟΝΗ RJ11 6P4C SOCKET MINI PHONE SINGLE RJ11 6P4C	65	65	30	1/10/200	2.21
2	5206139106445	147-16244	ΠΡΙΖΑ MINI ΤΗΛΕΦΩΝΟΥ ΔΙΠΛΗ RJ11 6P4C SOCKET MINI PHONE DOUBLE RJ11 6P4C	65	65	30	1/10/200	3.08

- ΕΞΩΤΕΡΙΚΟΙ ΔΙΑΚΟΠΤΕΣ & ΠΡΙΖΕΣ
- SURFACE SIMPLE SWITCH OUTDOOR

- ΥΛΙΚΟ ΚΑΤΑΣΚΕΥΗΣ: **PLASTIC & COPPER**
- PRODUCTION MATERIAL: **ΠΛΑΣΤΙΚΟ & ΧΑΛΚΟΣ**



	BARCODE	CODE	DESCRIPTION	mm	mm	mm	PACKING	PRICE [€]
1	5206139106452	147-16245	ΠΡΙΖΑ MINI DATA ΜΟΝΗ RJ45 8P8C SOCKET MINI DATA SINGLE RJ45 8P8C	65	65	30	1/10/200	2.72
2	5206139106469	147-16246	ΠΡΙΖΑ MINI DATA ΔΙΠΛΗ RJ45 8P8C SOCKET MINI PHONE DOUBLE RJ45 8P8C	65	65	30	1/10/200	4.16

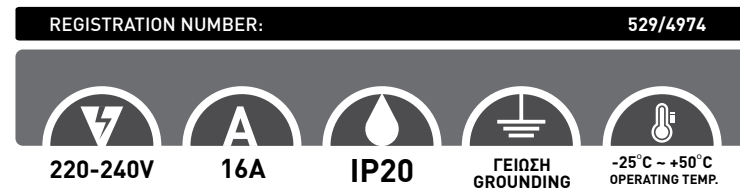
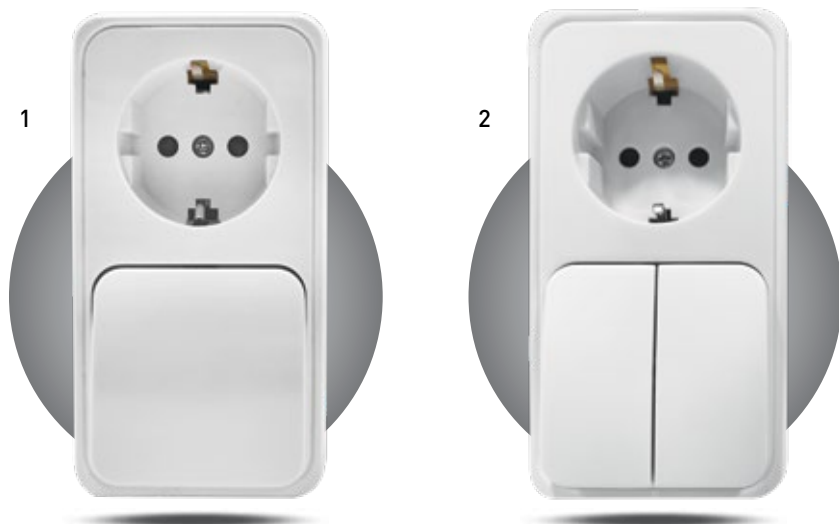

	BARCODE	CODE	DESCRIPTION	WATT	mm	mm	mm	PACKING	PRICE [€]
1	5206139106704	147-16250	ΠΡΙΖΑ ΣΟΥΚΟ ΜΙΝΙ ΚΑΙ ΔΙΑΚΟΠΤΗΣ A/R SCHUKO SOCKET MINI WITH SWITCH A/R	3840	110	65	45	1/5/50	4.85
2	5206139106711	147-16251	ΠΡΙΖΑ ΣΟΥΚΟ ΜΙΝΙ ΚΑΙ ΔΙΑΚΟΠΤΗΣ K/R SCHUKO SOCKET MINI WITH SWITCH K/R	3840	110	65	45	1/5/50	3.90

- ΕΞΩΤΕΡΙΚΟΙ ΔΙΑΚΟΠΤΕΣ & ΠΡΙΖΕΣ
- SURFACE SIMPLE SWITCH OUTDOOR

- ΥΛΙΚΟ ΚΑΤΑΣΚΕΥΗΣ: **PLASTIC & COPPER**
- PRODUCTION MATERIAL: **ΠΛΑΣΤΙΚΟ & ΧΑΛΚΟΣ**

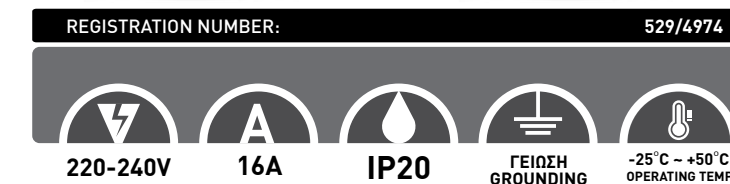
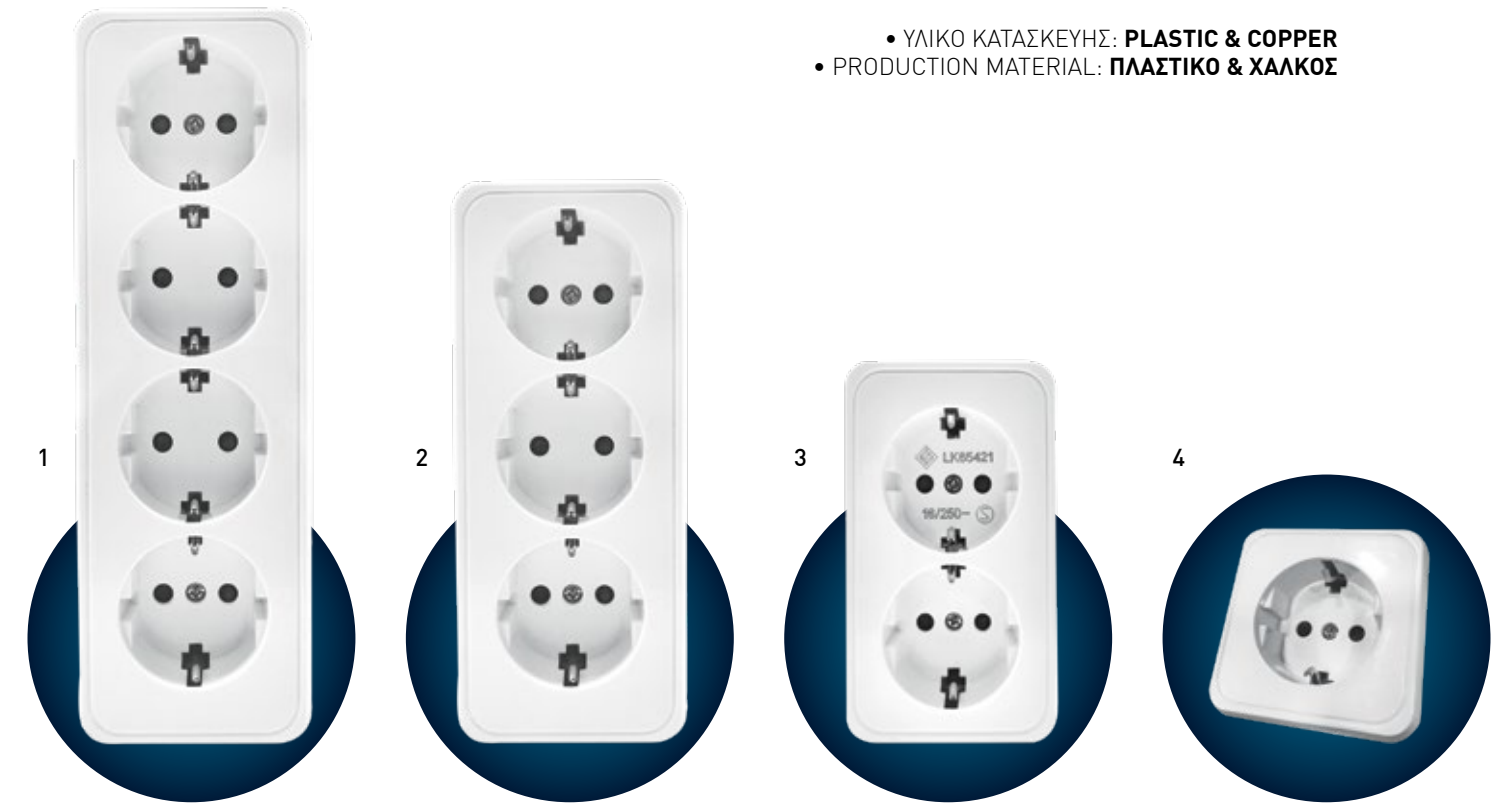

	BARCODE	CODE	DESCRIPTION	WATT	mm	mm	mm	PACKING	PRICE [€]
4	5206139106728	147-16252	ΠΡΙΖΑ ΜΙΝΙ ΣΟΥΚΟ ΜΟΝΗ ΧΩΡΙΣ ΚΑΠΑΚΙ SOCKET MINI SCHUKO SINGLE WITHOUT COVER	3840	65	65	30	1/20/200	2.06
3	5206139106735	147-16253	ΠΡΙΖΑ ΜΙΝΙ ΣΟΥΚΟ ΔΙΠΛΗ ΧΩΡΙΣ ΚΑΠΑΚΙ SOCKET MINI SCHUKO DOUBLE WITHOUT COVER	3840	110	65	45	1/20/160	3.68
2	5206139106742	147-16254	ΠΡΙΖΑ ΜΙΝΙ ΣΟΥΚΟ ΤΡΙΠΛΗ ΧΩΡΙΣ ΚΑΠΑΚΙ SOCKET MINI SCHUKO TRIPLE WITHOUT COVER	3840	145	65	45	1/12/144	4.72
1	5206139106759	147-16255	ΠΡΙΖΑ ΜΙΝΙ ΣΟΥΚΟ ΤΕΤΡΑΠΛΗ ΧΩΡΙΣ ΚΑΠΑΚΙ SOCKET MINI SCHUKO QUADRUPLE WITHOUT COVER	3840	195	65	45	1/10/80	6.32

- ΕΞΩΤΕΡΙΚΟΙ ΔΙΑΚΟΠΤΕΣ & ΠΡΙΖΕΣ / ΛΕΥΚΗ ΣΕΙΡΑ
- SURFACE SIMPLE SWITCH OUTDOOR / WHITE SERIE

• ΥΛΙΚΟ ΚΑΤΑΣΚΕΥΗΣ: **PLASTIC & COPPER**  
 • PRODUCTION MATERIAL: **ΠΛΑΣΤΙΚΟ & ΧΑΛΚΟΣ**



	BARCODE	CODE	DESCRIPTION	WATT	mm	mm	mm	PACKING	PRICE [€]
1	5206139075451	147-12210	ΔΙΑΚΟΠΤΗΣ ΕΞΩΤΕΡΙΚΟΣ ΑΠΛΟΣ SURFACE SIMPLE SWITCH OUTDOOR	2400	70	70	50	1/10/100	2.56
2	5206139075468	147-12211	ΔΙΑΚΟΠΤΗΣ ΕΞΩΤΕΡΙΚΟΣ Α/Ρ SURFACE A/R SWITCH OUTDOOR	2400	70	70	50	1/10/100	2.78
3	5206139075475	147-12212	ΔΙΑΚΟΠΤΗΣ ΕΞΩΤΕΡΙΚΟΣ Κ/Ρ SURFACE K/R SWITCH OUTDOOR	2400	70	70	50	1/10/100	3.06

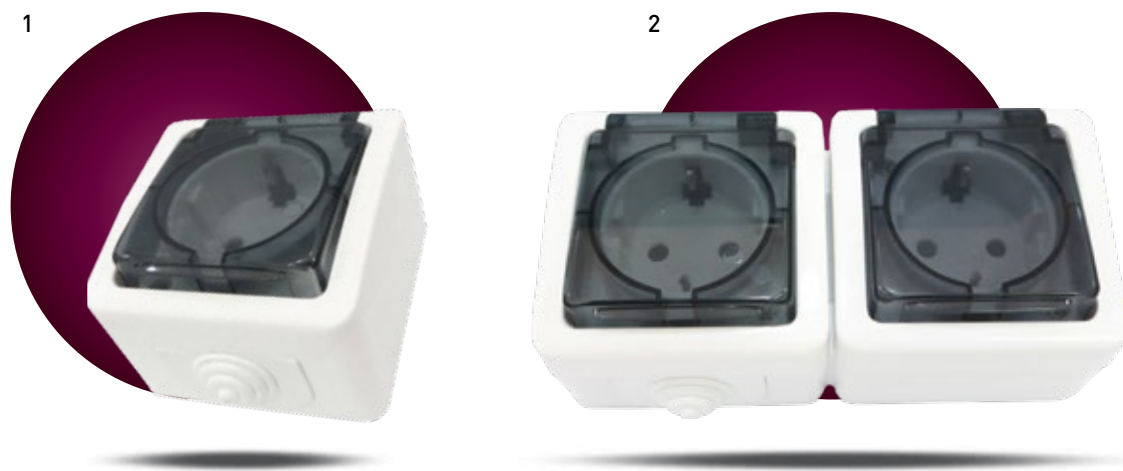

	BARCODE	CODE	DESCRIPTION	WATT	mm	mm	mm	PACKING	PRICE [€]
1	5206139075529	147-16220	ΠΡΙΖΑ ΣΟΥΚΟ ΜΕ ΚΑΠΑΚΙ SCHUKO SOCKET OUTDOOR WITH COVER	3840	70	70	50	1/10/100	3.08
2	5206139075536	147-16221	ΠΡΙΖΑ ΣΟΥΚΟ ΔΙΠΛΗ ΜΕ ΚΑΠΑΚΙ SCHUKO SOCKET OUTDOOR DOUBLE WITH COVER	3840	145	75	50	1/5/50	5.35

- ΕΞΩΤΕΡΙΚΟΙ ΔΙΑΚΟΠΤΕΣ & ΠΡΙΖΕΣ / ΓΚΡΙ ΣΕΙΡΑ
- SURFACE SIMPLE SWITCH OUTDOOR / GRAY SERIE

• ΥΛΙΚΟ ΚΑΤΑΣΚΕΥΗΣ: **PLASTIC & COPPER**  
 • PRODUCTION MATERIAL: **ΠΛΑΣΤΙΚΟ & ΧΑΛΚΟΣ**

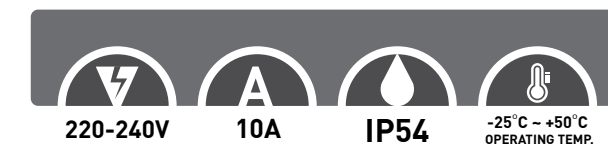
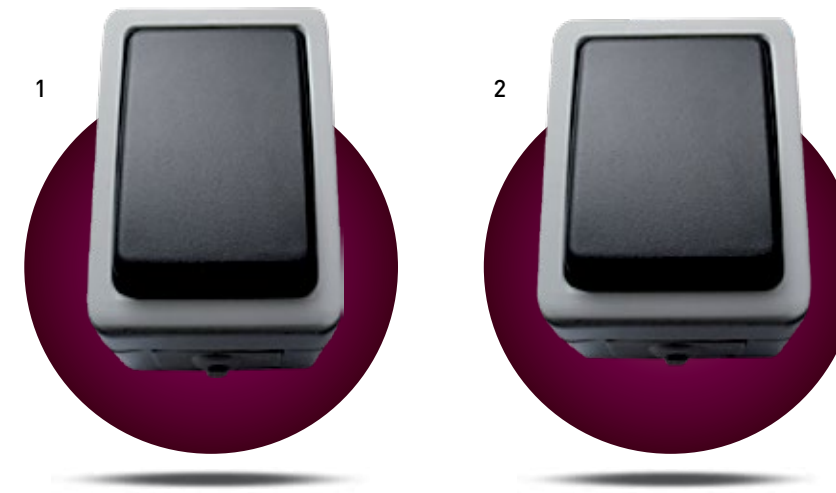

	BARCODE	CODE	DESCRIPTION	WATT	mm	mm	mm	PACKING	PRICE [€]
1	5206139105301	147-12230	ΔΙΑΚΟΠΤΗΣ ΕΞΩΤΕΡΙΚΟΣ ΑΠΛΟΣ SURFACE SIMPLE SWITCH OUTDOOR	2400	70	70	50	1/10/100	2.56
2	5206139105318	147-12231	ΔΙΑΚΟΠΤΗΣ ΕΞΩΤΕΡΙΚΟΣ Α/Ρ SURFACE A/R SWITCH OUTDOOR	2400	70	70	50	1/10/100	2.78

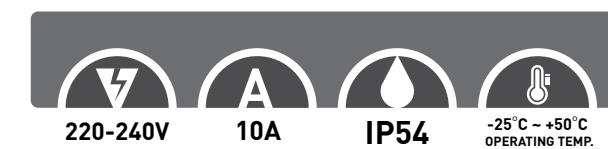
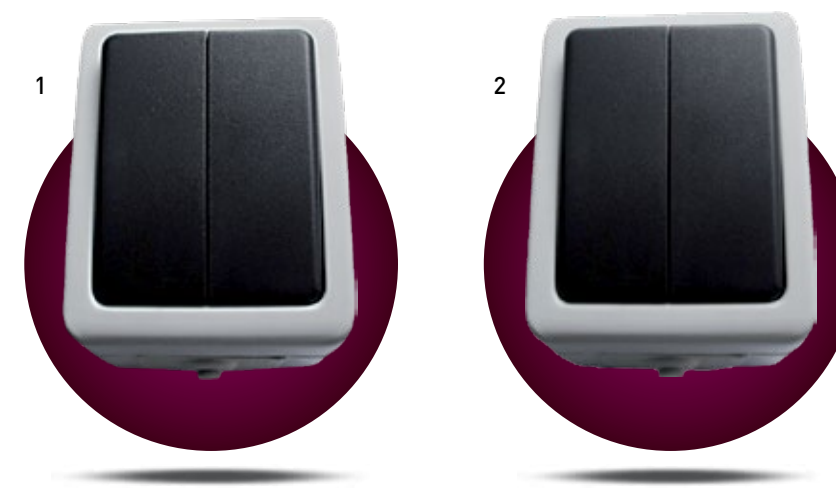

	BARCODE	CODE	DESCRIPTION	WATT	mm	mm	mm	PACKING	PRICE [€]
1	5206139105325	147-12232	ΔΙΑΚΟΠΤΗΣ ΕΞΩΤΕΡΙΚΟΣ Κ/Ρ SURFACE K/R SWITCH OUTDOOR	2400	70	70	50	1/10/100	3.06
2	5206139105332	147-12233	ΔΙΑΚΟΠΤΗΣ ΕΞΩΤΕΡΙΚΟΣ Κ/Ρ - Α/Ρ SURFACE A/R - K/R SWITCH OUTDOOR	2400	70	70	50	1/10/100	3.85

- ΕΞΩΤΕΡΙΚΟΙ ΔΙΑΚΟΠΤΕΣ & ΠΡΙΖΕΣ / ΓΚΡΙ ΣΕΙΡΑ
- SURFACE SIMPLE SWITCH OUTDOOR / GRAY SERIE

- ΥΛΙΚΟ ΚΑΤΑΣΚΕΥΗΣ: **PLASTIC & COPPER**
- PRODUCTION MATERIAL: **ΠΛΑΣΤΙΚΟ & ΧΑΛΚΟΣ**



	BARCODE	CODE	DESCRIPTION	WATT	mm	mm	mm	PACKING	PRICE (€)
1	5206139105363	147-12236	ΜΠΟΥΤΟΝ ΕΞΩΤΕΡΙΚΟ ΚΟΥΔΟΥΝΙΟΥ SURFACE BELL PUSH-BUTTON OUTDOOR	2400	70	70	50	1/10/100	2.85



	BARCODE	CODE	DESCRIPTION	WATT	mm	mm	mm	PACKING	PRICE (€)
1	5206139106100	147-16210	ΠΡΙΖΑ ΕΞΩΤΕΡΙΚΗ ΣΟΥΚΟ ΜΕ ΚΑΠΑΚΙ SCHUKO SOCKET OUTDOOR WITH COVER	3840	70	70	50	1/10/100	3.08
2	5206139106131	147-16213	ΠΡΙΖΑ ΣΟΥΚΟ ΔΙΠΛΗ ΜΕ ΚΑΠΑΚΙ SCHUKO SOCKET OUTDOOR DOUBLE WITH COVER	3840	145	75	50	1/5/50	5.35

- ΕΞΩΤΕΡΙΚΟΙ ΔΙΑΚΟΠΤΕΣ & ΠΡΙΖΕΣ / ΓΚΡΙ ΣΕΙΡΑ
- SURFACE SIMPLE SWITCH OUTDOOR / GRAY SERIE

- ΥΛΙΚΟ ΚΑΤΑΣΚΕΥΗΣ: **PLASTIC & COPPER**
- PRODUCTION MATERIAL: **ΠΛΑΣΤΙΚΟ & ΧΑΛΚΟΣ**



	BARCODE	CODE	DESCRIPTION	WATT	mm	mm	mm	PACKING	PRICE (€)
1	5206139106155	147-16215	ΔΙΑΚΟΠΤΗΣ Α/R ΚΑΙ ΠΡΙΖΑ ΣΟΥΚΟ SCHUKO SOCKET OUTDOOR WITH SWITCH A/R	3840	145	75	50	1/5/50	5.45



	BARCODE	CODE	DESCRIPTION	WATT	mm	mm	mm	PACKING	PRICE (€)
1	5206139106162	147-16216	ΔΙΑΚΟΠΤΗΣ Κ/R - Α/R ΚΑΙ ΠΡΙΖΑ ΣΟΥΚΟ SCHUKO SOCKET OUTDOOR WITH SWITCH K/R - A/R	3840	145	75	50	1/5/50	6.25

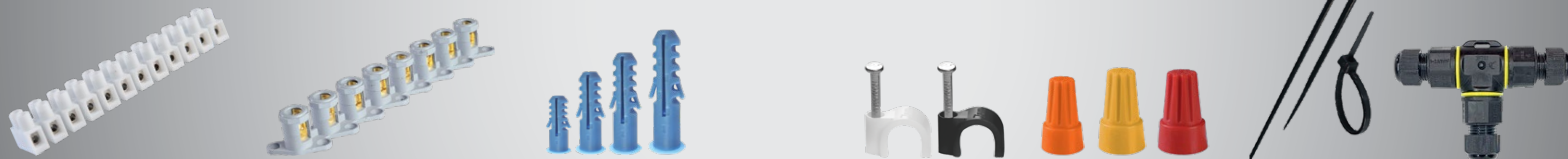

- Κλέμες / Κυπαρισσάκια / Ούπα / Ρόκες / Κάψες Καλωδίων / Δεματικά / Σύνδεσμοι Καλωδίων

- Terminal Blocks / Expand Plugs / Cable Clips / Cable Ties / Wire Connectors

**EUROLAMP<sup>®</sup>**  
Electrical Equipment

Discover our Collection ►

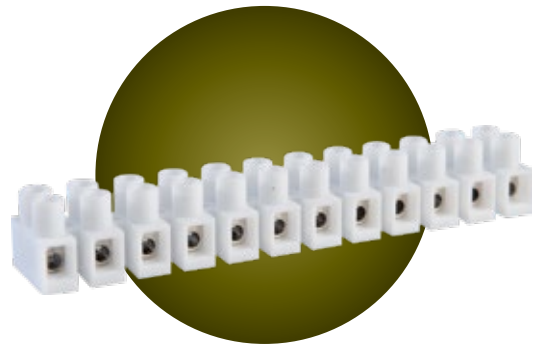

• ΚΛΕΜΑ ΠΟΛΥΠΡΟΠΥΛΕΝΙΟΥ  
• TERMINAL BLOCKS POLYPROPYLENE

• ΥΛΙΚΟ ΚΑΤΑΣΚΕΥΗΣ: PP  
• PRODUCTION MATERIAL: PP

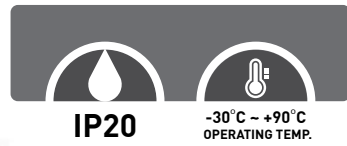

BARCODE	CODE	COLOR	SIZE mm	AMPERE	mm	mm	mm	PACKING	PRICE (€)
5206139111005	147-11000	WHITE	2.5	3	90.3	15.5	11.5	10/1000	0.62
5206139111012	147-11001	WHITE	4	3	90.3	15.5	11.5	10/1000	0.74
5206139111029	147-11002	WHITE	6	6	110.5	15.5	12.4	10/800	0.99
5206139111036	147-11003	WHITE	10	10	116.7	20.0	14.9	10/500	1.42
5206139111043	147-11004	WHITE	16	30	164.6	25.0	18.8	10/300	1.92
5206139111050	147-11005	WHITE	25	60	187.6	29.0	23.5	10/200	2.24

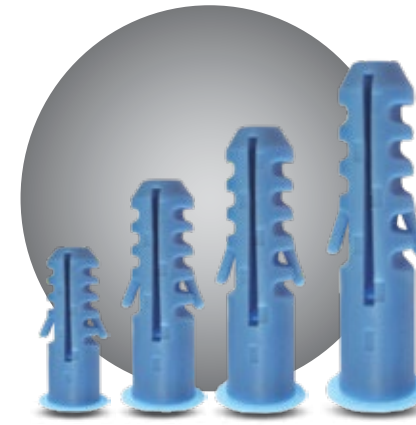

• ΟΥΠΑ • EXPAND PLUG

• ΥΛΙΚΟ ΚΑΤΑΣΚΕΥΗΣ: PE  
• PRODUCTION MATERIAL: PE

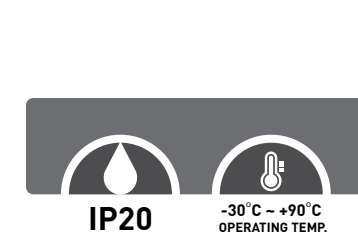

BARCODE	CODE	COLOR	SIZE	mm	mm	PACKING	PRICE (€)
5207227032684	147-11300	Blue	No: 6	29.8	4	100 (Nylon Bag) / 20000	0.88
5207227032714	147-11302	Blue	No: 8	39.2	5	100 (Nylon Bag) / 10000	1.96
5207227032745	147-11303	Blue	No: 10	44	6	50 (Nylon Bag) / 10000	1.48
5207227032776	147-11304	Blue	No: 12	48.3	7	25 (Nylon Bag) / 1000	1.27

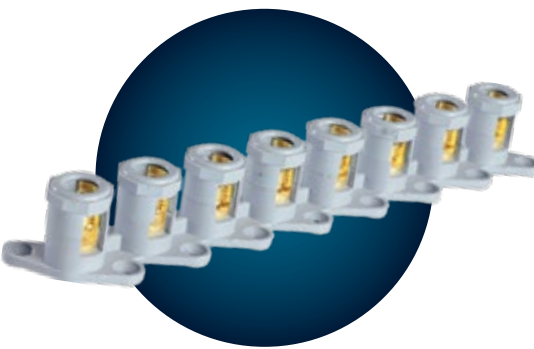

• ΚΥΠΑΡΙΣΣΑΚΙΑ • TERMINAL T8 BLOCKS

• ΥΛΙΚΟ ΚΑΤΑΣΚΕΥΗΣ: ΠΟΛΥΑΜΙΔΙΟ  
• PRODUCTION MATERIAL: POLYAMIDE

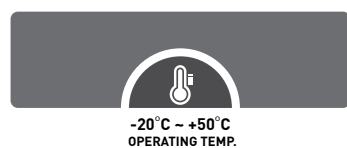

BARCODE	CODE	COLOR	SIZE mm	mm	mm	mm	WEIGHT (kg):	PACKING	PRICE (€)
5206139101006	147-11200	GRAY	16	173	26.4	23.6	0.097	1/10/200	4.86
5207227022715	147-11201	GRAY	25	206	31.4	27.0	0.131	1/10/100	5.85
5207227022708	147-11202	GRAY	35	251	41.5	32.3	0.267	1/10/80	10.60
5206139101044	147-11204	GRAY	70	271	43.5	37.9	0.272	1/10/40	13.35

• ΔΙΑΚΟΠΤΑΚΙΑ ΕΝΔΙΑΜΕΣΑ • MIDDLE SWITCHES

• ΥΛΙΚΟ ΚΑΤΑΣΚΕΥΗΣ: PLASTIC & COPPER  
• PRODUCTION MATERIAL: ΠΛΑΣΤΙΚΟ & ΧΑΛΚΟΣ



BARCODE	CODE	DESCRIPTION	WATT	mm	mm	mm	PACKING	PRICE (€)
5206139100443	147-10044	ΔΙΑΚΟΠΤΑΚΙ ΕΝΔΙΑΜΕΣΟ ΛΕΥΚΟ SWITCH MIDDLE WHITE	1440	12	32	12	10/480	1.32
5206139100450	147-10045	ΔΙΑΚΟΠΤΑΚΙ ΕΝΔΙΑΜΕΣΟ ΜΑΥΡΟ SWITCH MIDDLE BLACK	1440	12	32	12	10/480	1.32

• ΚΑΨΕΣ ΚΑΛΩΔΙΩΝ • WIRE CONNECTORS

• ΥΛΙΚΟ ΚΑΤΑΣΚΕΥΗΣ • PRODUCTION MATERIAL: PA66

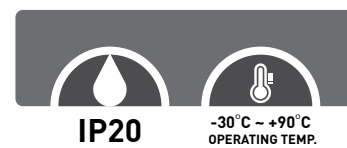
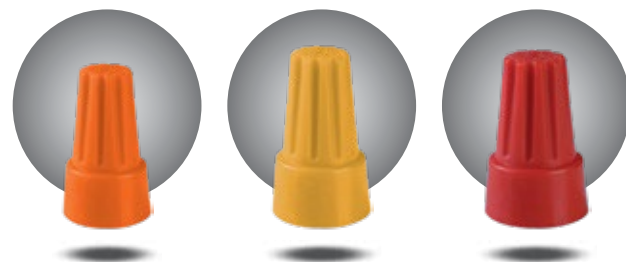

BARCODE	CODE	COLOR	SIZE mm	mm	mm	PACKING	PRICE (€)
5206139220103	147-02010	Orange	1.5	20	11.5	100 (Nylon Bag) / 10000	3.95
5206139220110	147-02011	Yellow	2.5	23.5	13.5	100 (Nylon Bag) / 5000	4.95
5206139220127	147-02012	Red	4	23.5	15.5	100 (Nylon Bag) / 5000	5.90

• ΣΥΝΔΕΣΜΟΣ ΚΑΛΩΔΙΩΝ • WIRE CONNECTOR  
• IP68

• ΥΛΙΚΟ ΚΑΤΑΣΚΕΥΗΣ: ΠΛΑΣΤΙΚΟ & ΧΑΛΚΟΣ  
• PRODUCTION MATERIAL: NYLON & COPPER

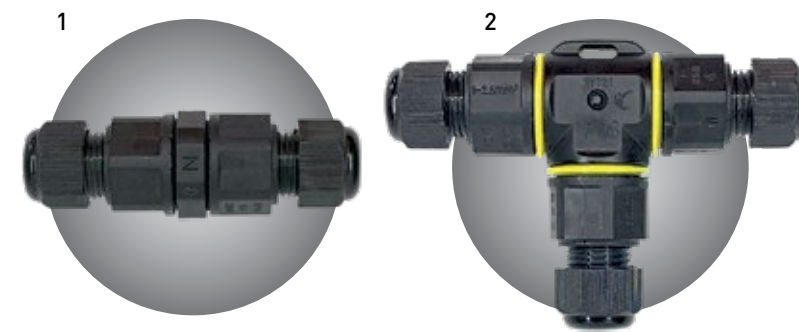

• Κατάλληλο για Καλώδια Διατομής: έως 3x1,5mm  
• Suitable for Cross Cable: to 3x1.5mm

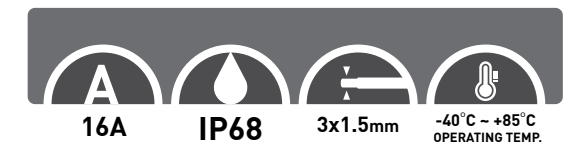

BARCODE	CODE	PACKING	PRICE (€)
1 5207227059339	147-11030	1/30/240	4.95
2 5207227059360	147-11031	1/30/240	7.93

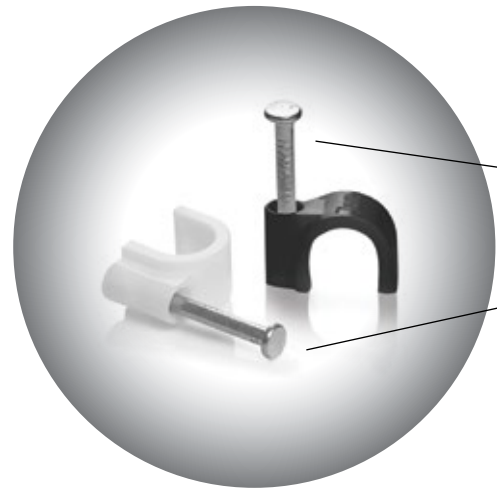

• ΠΟΚΑ • CABLE CLIPS

• ΥΛΙΚΟ ΚΑΤΑΣΚΕΥΗΣ: PE & ΑΤΣΑΛΙ  
• PRODUCTION MATERIAL: PE & STEEL

• Ατσάλοκαρφο Γερμανίας  
• Germany Steel



BARCODE	CODE	COLOR	SIZE	mm	WEIGHT (Kgr):	PACKING	PRICE (€)
5206139067593	147-48000	○	No: 5/20	6	0.065	1x100/300x100	0.85
5206139067609	147-48001	○	No: 6/25	8	0.080	1x100/200x100	1.28
5206139067616	147-48002	○	No: 7/25	8.7	0.085	1x100/200x100	1.42
5206139067623	147-48003	○	No: 8/25	9.5	0.106	1x100/200x100	1.48
5206139067630	147-48004	○	No: 9/25	11	0.121	1x100/100x100	1.68
5206139067647	147-48005	○	No: 10/25	12	0.141	1x100/100x100	1.92
5206139067746	147-48010	○	No: 6/35	8	0.098	1x100/200x100	1.42
5206139067753	147-48011	○	No: 7/35	8.7	0.101	1x100/200x100	1.54
5206139067760	147-48012	○	No: 8/35	9.5	0.128	1x100/100x100	1.58
5206139067777	147-48013	○	No: 9/35	11	0.145	1x100/100x100	1.78
5206139067784	147-48014	○	No: 10/35	12	0.158	1x100/100x100	1.96
5206139067791	147-48015	○	No: 12/35	13.5	0.203	1x100/100x100	2.68
5206139067807	147-48016	○	No: 14/35	16.5	0.258	1x100/100x100	3.48
5206139067814	147-48017	○	No: 16/35	18	0.301	1x100/50x100	3.67
5206139067821	147-48019	○	No: 20/45	22.5	0.251	1x50/50x50	3.82
5206139067845	147-48020	○	No: 22/45	23.5	0.285	1x50/50x50	3.92
5207227060816	147-48031	●	No: 6/25	8	0.080	1x100/200x100	1.28
5207227060830	147-48032	●	No: 7/25	8.7	0.085	1x100/200x100	1.42
5207227060854	147-48033	●	No: 8/25	9.5	0.106	1x100/200x100	1.48
5207227060878	147-48034	●	No: 9/25	11	0.121	1x100/100x100	1.68

• ΑΥΤΟΚΟΛΛΗΤΕΣ ΒΑΣΕΙΣ • SELF ADHESIVE TIE MOUNTS

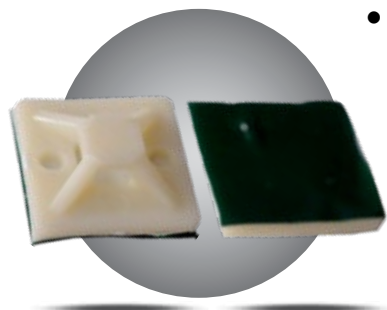

• ΥΛΙΚΟ ΚΑΤΑΣΚΕΥΗΣ: ABS  
• PRODUCTION MATERIAL: ABS

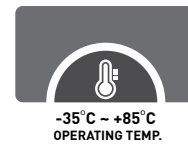

Nylon Bag & Papercard PACKING



BARCODE	CODE	COLOR	mm	mm	mm	PACKING	PRICE (€)
5206139540331	147-54033	○	20	20	6.1	1x100/200x100	3.85
5206139540348	147-54034	○	30	30	8.7	1x100/70x100	5.35

**EUROLAMP®**  
Electrical Equipment

• ΔΕΜΑΤΙΚΑ • CABLE-TIES

• ΥΛΙΚΟ ΚΑΤΑΣΚΕΥΗΣ • PRODUCTION MATERIAL: PA66

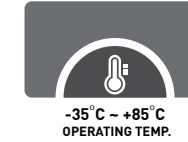

Nylon Bag & Papercard PACKING



• Αντοχή στην διάβρωση

• Erosion Control

• Αντοχή σε υψηλές θερμοκρασίες

• Resistance to high temperatures

• Υλικό Κατασκευής: NYLON 66 94V-2 UL

• Detection Distance: NYLON 66 94V-2 UL

• Χώρα προέλευσης πρώτης ύλης: Vydyne® by USA

• Raw material's country of origin: Vydyne® by USA



BARCODE	CODE	COLOR	mm	PACKING	PRICE (€)
5206139540027	147-54002	○	120 x 2.5	1x100/500x100	0.66
5206139540041	147-54004	○	160 x 2.5	1x100/500x100	0.96
5206139540058	147-54005	○	200 x 2.5	1x100/150x100	1.22
5206139004413	147-54006	○	150 x 3.6	1x100/104x100	1.38
5206139540072	147-54007	○	200 x 3.6	1x100/75x100	1.88
5206139540089	147-54008	○	250 x 3.6	1x100/75x100	2.18
5206139540126	147-54012	○	200 x 4.8	1x100/70x100	2.72
5206139540133	147-54013	○	250 x 4.8	1x100/120x100	3.28
5206139540140	147-54014	○	300 x 4.8	1x100/50x100	3.88
5206139540157	147-54015	○	350 x 4.8	1x100/40x100	4.65
5206139540164	147-54016	○	450 x 4.8	1x100/31x100	5.85
5206139004789	147-54017	○	350 x 7.6	1x100/25x100	9.35
5206139540218	147-54021	○	550 x 7.6	1x100/15x100	18.85
5206139541024	147-54102	●	120 x 2.5	1x100/500x100	0.66
5206139541048	147-54104	●	160 x 2.5	1x100/500x100	0.96
5206139541055	147-54105	●	200 x 2.5	1x100/150x100	1.22
5206139541062	147-54106	●	150 x 3.6	1x100/104x100	1.38
5206139541079	147-54107	●	200 x 3.6	1x100/75x100	1.88
5206139541086	147-54108	●	250 x 3.6	1x100/75x100	2.18
5206139541123	147-54112	●	200 x 4.8	1x100/70x100	2.72
5206139541130	147-54113	●	250 x 4.8	1x100/120x100	3.28
5206139541147	147-54114	●	300 x 4.8	1x100/50x100	3.88
5206139541154	147-54115	●	350 x 4.8	1x100/40x100	4.65
5206139004796	147-54116	●	450 x 4.8	1x100/31x100	5.85
5206139004802	147-54117	●	350 x 7.6	1x100/25x100	9.35
5206139015082	147-54121	●	550 x 7.6	1x100/15x100	18.85
5206139050199	147-54062	●	200 x 2.5	1x100/150x100	1.38





- Ντουί Πορσελάνης - Μεταλλικά - Κρεμαστά / Αντάπτορες / Φωτάκια Νυχτός LED
- Lampholders Porcelain - Metallic - Hanging / Adaptors / LED Night Lights

**EUROLAMP<sup>®</sup>**  
Electrical Equipment

Discover our Collection ►

• ΝΤΟΥΙ • LAMPHOLDERS



BARCODE	CODE	COLOR	SPECIAL DESCRIPTION	BASEHOLD	IP	MATERIAL	PACKING	PRICE (€)
1 5206139108104	147-23010	●	ΡΟΔΕΛΑΣ / RING	E14	IP20	BAKELITE	30/300	0.72
2 5206139108111	147-23011	●	ΡΟΔΕΛΑΣ / RING	E27	IP20	BAKELITE	30/240	0.82
3 5206139108302	147-23030	○		E27	IP20	BAKELITE	1/50/600	0.73
4 5206139108319	147-23031	○		E14	IP20	BAKELITE	1/50/1200	0.49
5 5206139108326	147-23032	●		E14	IP20	BAKELITE	1/50/1200	0.49
6 5206139108333	147-23033	○	ΒΑΡΕΛΑΚΙ	B22	IP20	BAKELITE	1/50/600	0.90
7 5206139108340	147-23034	○	ΣΤΕΓΑΝΟ / WATERPROOF	E27	IP44	BAKELITE	1/50/600	0.68
8 5207227041891	147-23036	●	ΚΟΥΜΠΩΤΟ / FAST CONNECTION	E27	IP20	BAKELITE	1/10/500	0.39
9 5207227068607	147-23037	●	ΓΙΡΛΑΝΤΑΣ ΣΤΕΓΑΝΟ GARLAND WATERPROOF	E27	IP44	BAKELITE	1/12/600	1.52

• ΝΤΟΥΙ ΟΡΕΙΧΑΛΚΙΝΟ  
• LAMPHOLDERS BRASS



BARCODE	CODE	COLOR	SPECIAL DESCRIPTION	BASEHOLD	IP	MATERIAL	PACKING	PRICE (€)
1 5206139108401	147-23040	●	ΟΡΕΙΧΑΛΚΙΝΟ / BRASS	E14	IP20	IRON	50/1000	0.96
2 5206139108418	147-23041	●	ΟΡΕΙΧΑΛΚΙΝΟ / BRASS	E27	IP20	IRON	20/400	1.08

• ΝΤΟΥΙ ΜΕΤΑΛΛΙΚΑ • ΜΕΤΑΛ LAMPHOLDERS  
• NICKEL/GOLD COLORS

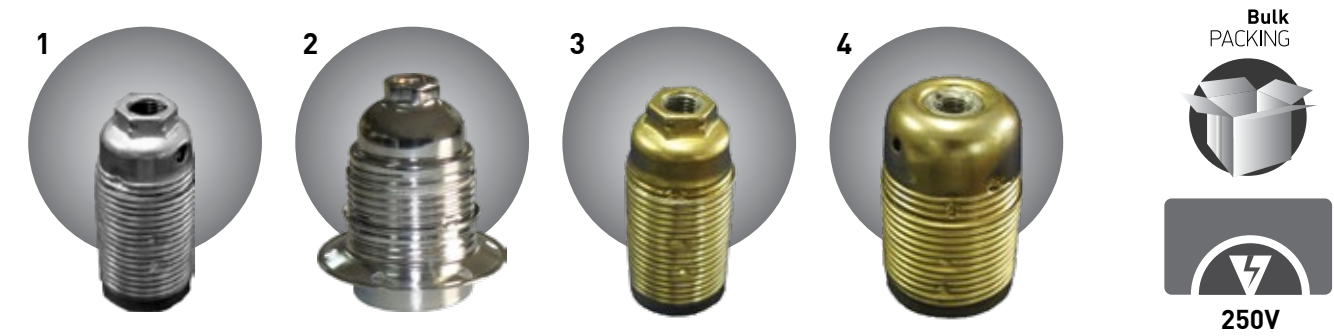

BARCODE	CODE	COLOR	SPECIAL DESCRIPTION	BASEHOLD	IP	MATERIAL	PACKING	PRICE (€)
1 5206139020123	147-23042	●	2 ΔΑΧΤΥΛΙΔΙΑ / 2 RINGS	E14	IP20	IRON	25/200	2.95
2 5206139020130	147-23043	●	2 ΔΑΧΤΥΛΙΔΙΑ / 2 RINGS	E27	IP20	IRON	32/256	3.38
3 5206139020147	147-23044	●	2 ΔΑΧΤΥΛΙΔΙΑ / 2 RINGS	E14	IP20	IRON	25/200	2.95
4 5206139020154	147-23045	●	2 ΔΑΧΤΥΛΙΔΙΑ / 2 RINGS	E27	IP20	IRON	25/200	3.38

• ΝΤΟΥΙ ΠΟΡΣΕΛΑΝΗΣ • LAMPHOLDERS PORCELAIN

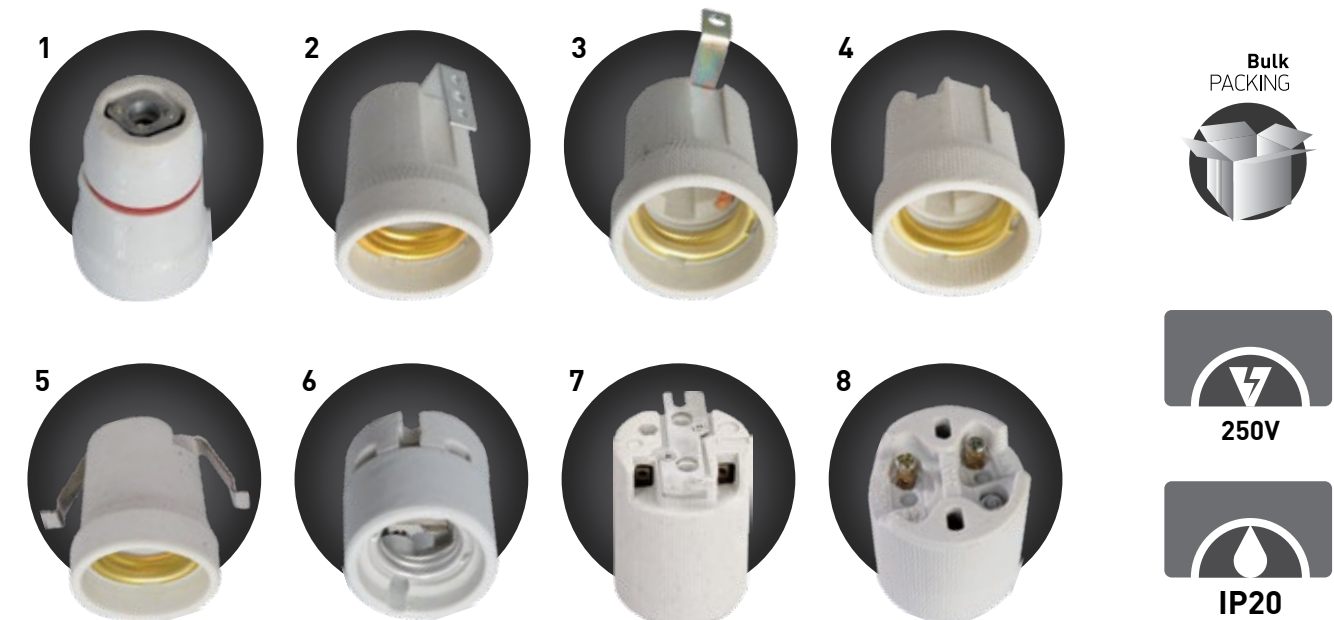

BARCODE	CODE	COLOR	SPECIAL DESCRIPTION	BASEHOLD	MATERIAL	PACKING	PRICE (€)
1 5206139108005	147-23000	○		E27	CERAMIC	20/200	0.43
2 5206139108029	147-23002	○	ΓΙΑ ΣΠΟΤ / FOR SPOT	E27	CERAMIC	20/200	0.35
3 5206139108036	147-23003	○	ΓΙΑ ΚΑΡΑΒΟΧΕΛΩΝΑ / FOR GUTTER	E27	CERAMIC	20/200	0.35
4 5206139108043	147-23004	○	ΣΚΕΤΟ / PLAIN	E27	CERAMIC	1/200	0.28
5 5206139108166	147-23016	○	ΜΕ 2 ΛΑΜΑΚΙΑ ΠΡΟΣ ΤΑ ΚΑΤΩ WITH TWO BARS	E27	CERAMIC	20/200	0.35
6 5206139108180	147-23018	○	ΠΛΑΦΟΝ / CAP	E27	CERAMIC	20/200	0.98
7 5206139108203	147-23020	○	ΣΚΕΤΟ ΜΕ ΛΑΜΑΚΙ / WITH BAR	E40	CERAMIC	1/80	1.62
8 5206139108227	147-23022	○	ΣΚΕΤΟ / PLAIN	E40	CERAMIC	10/100	1.62

• ΝΤΟΥΙ ΠΟΡΣΕΛΑΝΗΣ • LAMPHOLDERS PORCELAIN

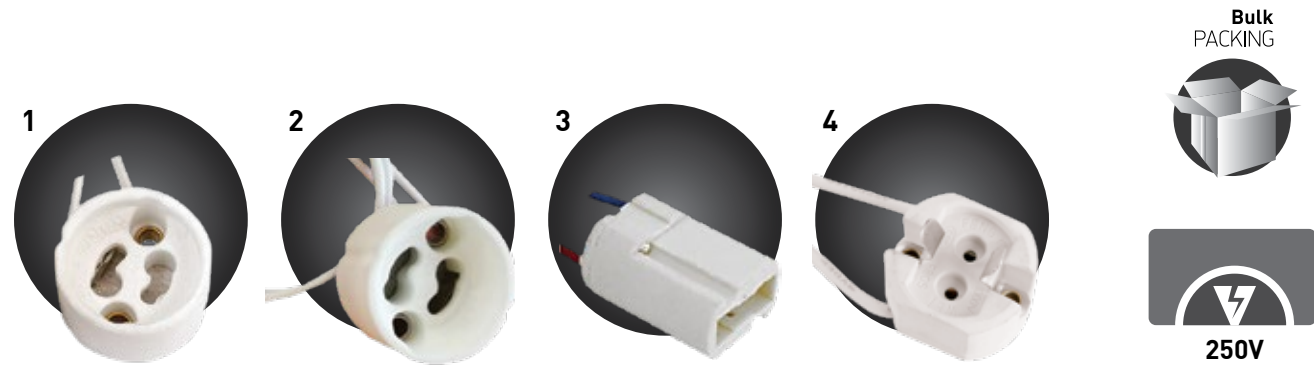

BARCODE	CODE	COLOR	SPECIAL DESCRIPTION	BASEHOLD	IP	MATERIAL	PACKING	PRICE (€)
1 5206139108128	147-23012	○		GU10	IP20	CERAMIC	50/500	0.41
2 5207227069208	147-23013	○	ΚΑΛΩΔΙΟ 25cm / CABLE 25cm	GU10	IP20	CERAMIC	50/500	0.48
3 5206139108142	147-23014	○		G9	IP20	CERAMIC	100/1000	0.52
4 5206139108159	147-23015	○		G12	IP20	CERAMIC	10/200	1.58

• ΝΤΟΥΙ ΑΝΤΑΠΤΟΡΕΣ • LAMPHOLDER ADAPTORS



BARCODE	CODE	SPECIAL DESCRIPTION	MATERIAL	PACKING	PRICE (€)
1 5206139108449	147-23050	ΑΠΟ E27 ΣΕ E40 / FROM E27 TO E40	PLASTIC	20/400	2.07
2 5206139108456	147-23051	ΑΠΟ E40 ΣΕ E27 / FROM E40 TO E27	PLASTIC	25/500	1.38
3 5206139108463	147-23052	ΑΠΟ E14 ΣΕ GU10 / FROM E14 TO GU10	PLASTIC	12/360	1.38
4 5206139108470	147-23053	ΑΠΟ E14 ΣΕ G9 / FROM E14 TO G9	PLASTIC	12/600	1.38
5 5206139108487	147-23054	ΑΠΟ E27 ΣΕ E14 / FROM E27 TO E14	PLASTIC	12/600	1.38
6 5206139108494	147-23055	ΑΠΟ B22 ΣΕ E27 / FROM B22 TO E27	PLASTIC	12/600	1.38
7 5206139009920	147-23056	ΑΠΟ E27 ΣΕ GU10 / FROM E27 TO GU10	PLASTIC	12/360	1.38
8 5206139053817	147-23057	ΑΠΟ E14 ΣΕ E27 / FROM E14 TO E27	PLASTIC	12/600	1.38

• ΝΤΟΥΙ ΚΡΕΜΑΣΤΑ • HANGING LAMPHOLDERS

BARCODE	CODE	DESCRIPTION	BASE	mm	PACKING	PRICE (€)
1 5206139100092	147-10009	ΝΤΟΥΙ ΒΑΚΕΛΙΤΟΥ ΚΡΕΜΑΣΤΟ LAMPHOLDER HANGING	E27	240 60	1/25/300	0.98
2 5206139108432	147-23100	ΝΤΟΥΙ ΚΡΕΜΑΣΤΟ (ΓΙΑ ΦΩΤΙΣΤΙΚΑ) LAMPHOLDER HANGING (FOR LIGHTINGS)	E27	640 74	1/50	2.65
3 5206139025234	147-23110	ΝΤΟΥΙ ΚΡΕΜΑΣΤΟ ΜΕ ΑΝΕΒΑΤΟΡ (ΓΙΑ ΦΩΤΙΣΤΙΚΑ) LAMPHOLDER HANGING WHITE (FOR LIGHTINGS)	E27	400-940 90	1/50	7.85
4 5206139037978	147-23115	ΝΤΟΥΙ ΚΡΕΜΑΣΤΟ ΜΕ ΑΛΥΣΙΔΑ ΓΙΑ ΚΑΜΠΑΝΑ LAMPHOLDER HANGING WHITE (FOR HIGH BAY)	E40	800 100	1/50	6.95

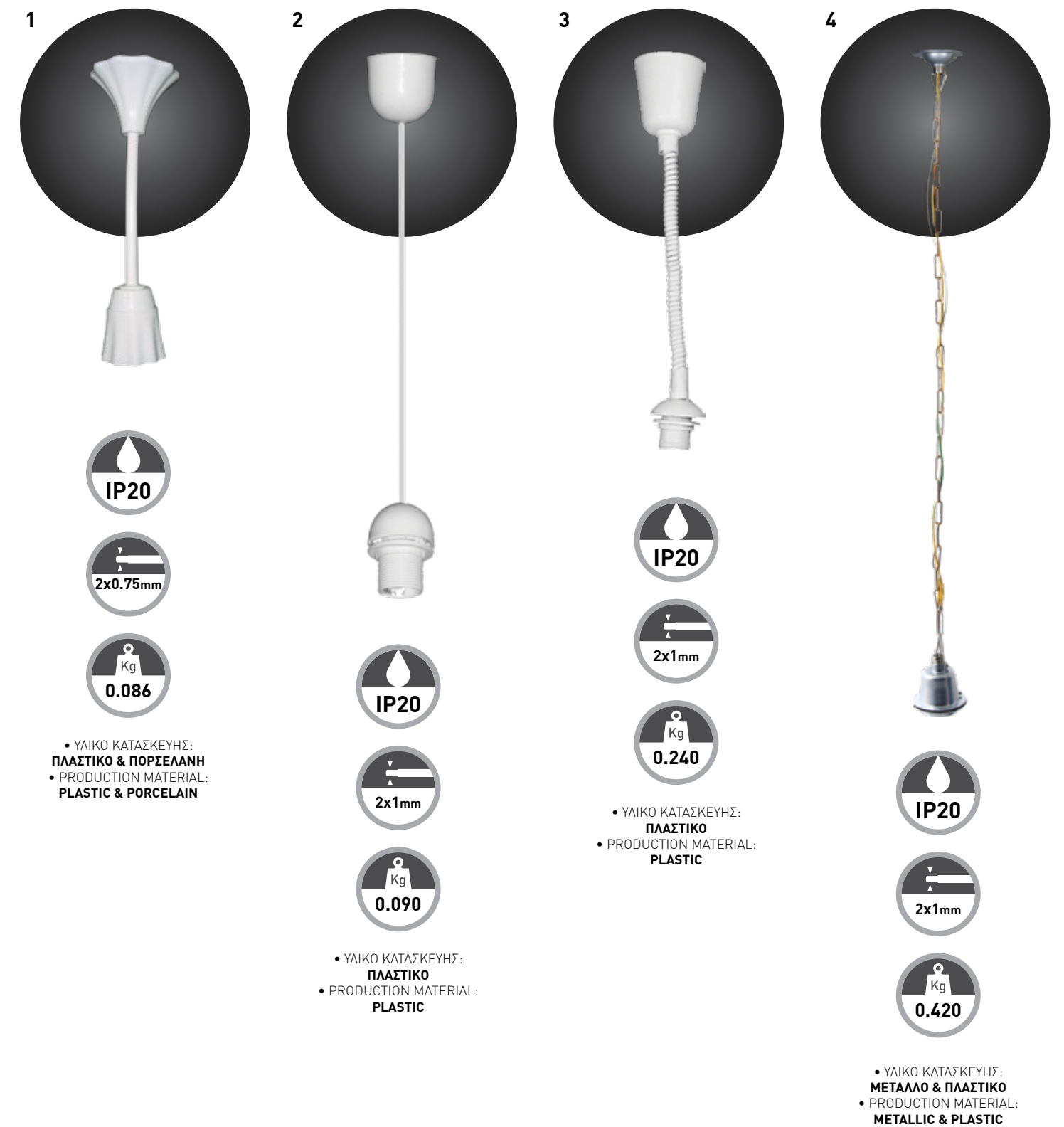

• ΝΤΟΥΙ ΚΡΕΜΑΣΤΑ • HANGING LAMPHOLDERS

	BARCODE	CODE	DESCRIPTION	BASE	⌀ mm	⊘	PACKING	PRICE (€)
1	5206139025241	147-23120	ΝΤΟΥΙ ΚΡΕΜΑΣΤΟ ΝΙΚΕΛ LAMPHOLDER HANGING NICKEL	E27	620	100	1/50	6.35
2	5206139025258	147-23121	ΝΤΟΥΙ ΚΡΕΜΑΣΤΟ ΑΝΤΙΚΕ LAMPHOLDER HANGING ANTIQUE BRASS	E27	620	100	1/50	6.35
3	5206139027764	147-23130	ΝΤΟΥΙ ΚΡΕΜΑΣΤΟ ΣΑΤΙΝΕ LAMPHOLDER HANGING SATIN	E27	620	100	1/50	8.25
4	5206139027771	147-23131	ΝΤΟΥΙ ΚΡΕΜΑΣΤΟ ΜΠΡΟΝΖΕ LAMPHOLDER HANGING ANTIQUE BRASS	E27	620	100	1/50	9.25



• ΥΛΙΚΟ ΚΑΤΑΣΚΕΥΗΣ:  
**ΜΕΤΑΛΛΟ & ΠΛΑΣΤΙΚΟ**  
• PRODUCTION MATERIAL:  
**METALLIC & PLASTIC**

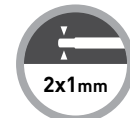

• ΥΛΙΚΟ ΚΑΤΑΣΚΕΥΗΣ:  
**ΜΕΤΑΛΛΟ & ΠΛΑΣΤΙΚΟ**  
• PRODUCTION MATERIAL:  
**METALLIC & PLASTIC**

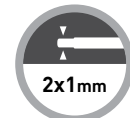

• ΥΛΙΚΟ ΚΑΤΑΣΚΕΥΗΣ:  
**ΜΕΤΑΛΛΟ & ΠΛΑΣΤΙΚΟ**  
• PRODUCTION MATERIAL:  
**METALLIC & PLASTIC**

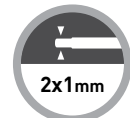

• ΥΛΙΚΟ ΚΑΤΑΣΚΕΥΗΣ:  
**ΜΕΤΑΛΛΟ & ΠΛΑΣΤΙΚΟ**  
• PRODUCTION MATERIAL:  
**METALLIC & PLASTIC**

• ΡΟΖΕΤΑ ΟΡΟΦΗΣ • IRON CUP PLATES

• ΥΛΙΚΟ ΚΑΤΑΣΚΕΥΗΣ: **ΜΕΤΑΛΛΙΚΟ**  
• PRODUCTION MATERIAL: **METALLIC**

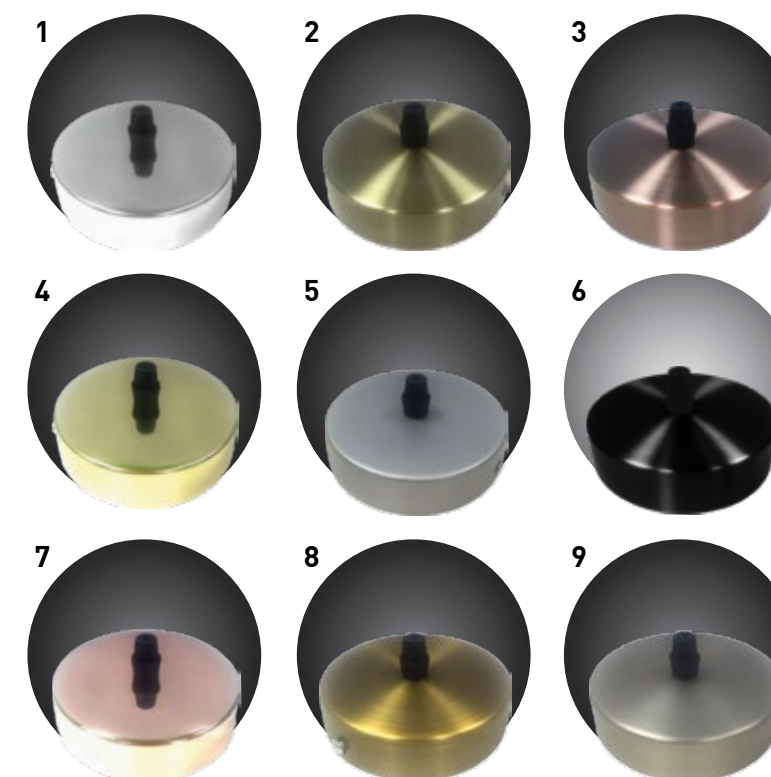

	BARCODE	CODE	COLOR	⌀ mm	⊘	PACKING	PRICE (€)
1	5206139073723	147-23070	ΝΙΚΕΛ / CHROME	25	100	1/20/100	2.65
2	5206139073730	147-23071	ΑΝΤΙΚΕ ΜΠΡΟΝΖΕ / ANTIQUE BRASS	25	100	1/20/100	2.65
3	5206139073747	147-23072	ΑΝΤΙΚΕ ΧΑΛΚΟΥ / ANTIQUE COPPER	25	100	1/20/100	2.65
4	5206139073761	147-23073	ΧΡΥΣΟ / GOLD	25	100	1/20/100	2.65
5	5206139073778	147-23074	ΑΝΤΙΚΕ ΑΣΗΜΙ / ANTIQUE SILVER	25	100	1/20/100	2.65
6	5206139044587	147-23075	ΜΑΥΡΗ / BLACK	25	100	1/20/100	2.65
7	5206139073792	147-23076	ΡΟΖ ΧΡΥΣΟ / PINK GOLD	25	100	1/20/100	2.65
8	5206139073808	147-23077	ΚΑΦΕ ΜΠΡΟΝΖΕ / BROWN BRONZE	25	100	1/20/100	2.65
9	5206139073822	147-23078	ΝΙΚΕΛ ΜΑΤ / CHROME MAT	25	100	1/20/100	2.65

- ΝΤΟΥΙ ΜΕΤΑΛΛΙΚΟ • LAMPHOLDER METALLIC
- **E27** BASEHOLD

- ΥΛΙΚΟ ΚΑΤΑΣΚΕΥΗΣ: **ΜΕΤΑΛΛΙΚΟ**
- PRODUCTION MATERIAL: **METALLIC**



	BARCODE	CODE	COLOR	mm	mm	PACKING	PRICE (€)
1	5206139034533	147-23060	ΝΙΚΕΛ / CHROME	70	50	1/20/100	4.70
2	5206139034540	147-23061	ΑΝΤΙΚΕ ΜΠΡΟΝΖΕ / ANTIQUE BRASS	70	50	1/20/100	4.70
3	5206139034557	147-23062	ΑΝΤΙΚΕ ΧΑΛΚΟΥ / ANTIQUE COPPER	70	50	1/20/100	4.70
4	5206139034564	147-23063	ΧΡΥΣΟ / GOLD	70	50	1/20/100	4.70
5	5206139034571	147-23064	ΑΝΤΙΚΕ ΑΣΗΜΙ / ANTIQUE SILVER	70	50	1/20/100	4.70
6	5206139067340	147-23066	ΡΟΖ ΧΡΥΣΟ / PINK GOLD	70	50	1/20/100	4.70
7	5206139067371	147-23067	ΚΑΦΕ ΜΠΡΟΝΖΕ / BROWN BRONZE	70	50	1/20/100	4.70
8	5206139073600	147-23068	ΝΙΚΕΛ ΜΑΤ / MAT CHROME	70	50	1/20/100	4.70

- ΚΑΛΩΔΙΟ ΚΟΡΔΟΝΙ ΧΡΩΜΑΤΙΣΤΟ
- COLORED CORD TYPE CABLE

- ΥΛΙΚΟ ΚΑΤΑΣΚΕΥΗΣ: **ΣΧΟΙΝΙ, ΑΛΟΥΜΙΝΙΟ & ΠΛΑΣΤΙΚΟ**
- PRODUCTION MATERIAL: **ROPE, ALUMINIUM & PLASTIC**

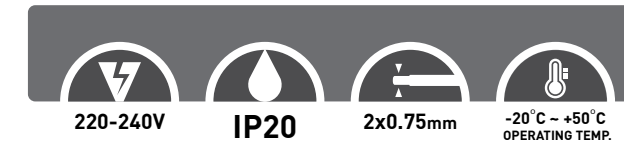
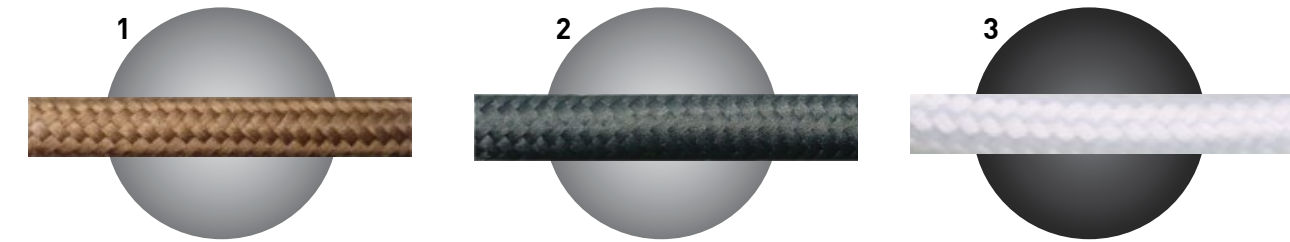

	BARCODE	CODE	COLOR	CABLE LENGTH (m)	PACKING	PRICE (€)
1	5206139033666	147-13305	ΚΑΦΕ / BROWN	50	50m / Roll	0.82
2	5206139033727	147-13310	ΜΑΥΡΟ / BLACK	50	50m / Roll	0.82
3	5206139073846	147-13313	ΛΕΥΚΟ / WHITE	50	50m / Roll	0.82

- ΒΑΣΗ ΓΛΟΜΠΟΥ ΒΑΚΕΛΙΤΟΥ
- GLASS GLOBE BASE BAKELITE WITH LAMPHOLDER

- ΥΛΙΚΟ ΚΑΤΑΣΚΕΥΗΣ: **ΠΛΑΣΤΙΚΟ & ΚΕΡΑΜΙΚΟ**
- PRODUCTION MATERIAL: **PLASTIC & CERAMIC**

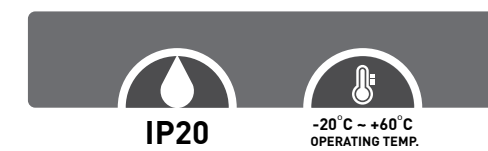
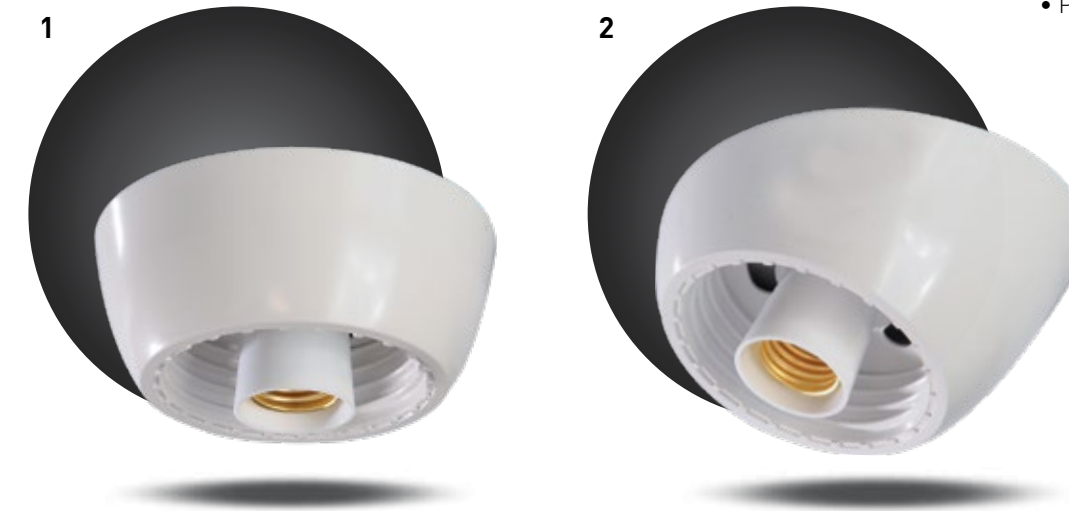

	BARCODE	CODE	DESCRIPTION	BASE	mm	mm	PACKING	PRICE (€)
1	5206139108531	147-22003	ΒΑΣΗ ΓΛΟΜΠΟΥ ΒΑΚΕΛΙΤΟΥ ΙΣΙΑ GLASS GLOBE BASE BAKELITE WITH LAMPHOLDER FLAT	E27	60	130	1/20/100	1.44
2	5206139108548	147-22004	ΒΑΣΗ ΓΛΟΜΠΟΥ ΒΑΚΕΛΙΤΟΥ ΚΥΡΤΗ GLASS GLOBE BASE BAKELITE WITH LAMPHOLDER ANGLE	E27	90	140	1/10/100	1.12



• ΓΥΑΛΙ ΓΛΟΜΠΟΥ • GLASS FOR GLOBE

• ΥΛΙΚΟ ΚΑΤΑΣΚΕΥΗΣ: ΓΥΑΛΙ  
• PRODUCTION MATERIAL: GLASS



BARCODE	CODE	COLOR	SPECIAL DESCRIPTION	DIAMETER	mm	WEIGHT (Kgr):	PACKING	PRICE (€)
5206139519993	153-65999	OPAL	ΟΠΑΛ ΑΡΜΑΤΟΥΡΑΣ OPAL	150	160	0.053	1/16	4.96

• ΦΩΤΑΚΙ ΝΥΚΤΟΣ LED ΜΕ USB ΚΑΙ ΦΩΤΟΚΥΤΤΑΡΟ  
• LED NIGHT LIGHT WITH SENSOR+USB

• ΥΛΙΚΟ ΚΑΤΑΣΚΕΥΗΣ: • PRODUCTION MATERIAL: PBT PLASTIC



• Αυτόματη Ενεργοποίηση • Auto ON/ OFF

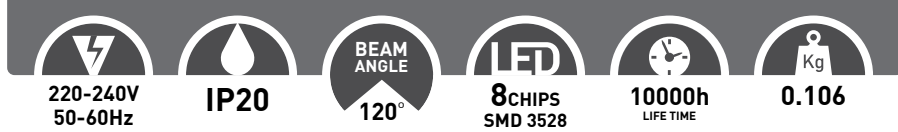

BARCODE	CODE	WATT	KELVIN	LUMEN	mm	mm	mm	PACKING	PRICE (€)
5206139074478	145-15060	1.5W	2700K	100	75	75	25	1/6/100	6.95

• ΦΩΤΑΚΙ ΝΥΚΤΟΣ LED / ΜΕ ΔΙΑΚΟΠΤΗ / 4 ΧΡΩΜΑΤΑ  
• LED NIGHT LIGHT WITH ON-OFF SWITCH / 4 COLORS

• ΥΛΙΚΟ ΚΑΤΑΣΚΕΥΗΣ: • PRODUCTION MATERIAL: PBT PLASTIC



• + 3 Ανταλλακτικά Χρωματιστά Καπάκια  
• + 3 Spare Colored Lids



BARCODE	CODE	WATT	KELVIN	WEIGHT (Kgr):	mm	mm	PACKING	PRICE (€)
5206139092229	147-15053	1W	2700K	0.102	100	28	1/16/64	3.85

• ΦΩΤΑΚΙ ΝΥΚΤΟΣ LED / ΜΕ ΦΩΤΟΚΥΤΤΑΡΟ / 4 ΧΡΩΜΑΤΑ  
• LED NIGHT LIGHT WITH SENSOR / 4 COLORS

• ΥΛΙΚΟ ΚΑΤΑΣΚΕΥΗΣ: • PRODUCTION MATERIAL: PBT PLASTIC



• + 3 Ανταλλακτικά Χρωματιστά Καπάκια  
• + 3 Spare Colored Lids



BARCODE	CODE	WATT	KELVIN	WEIGHT (Kgr):	mm	mm	PACKING	PRICE (€)
5206139092281	147-15054	1W	2700K	0.099	100	28	1/16/64	3.92

• ΦΩΤΑΚΙ ΝΥΚΤΟΣ LED / ΜΕ ΦΩΤΟΚΥΤΤΑΡΟ  
• LED NIGHT LIGHT WITH SENSOR

• ΥΛΙΚΟ ΚΑΤΑΣΚΕΥΗΣ: • PRODUCTION MATERIAL: PBT PLASTIC



• Αυτόματη Ενεργοποίηση  
• Auto ON/ OFF

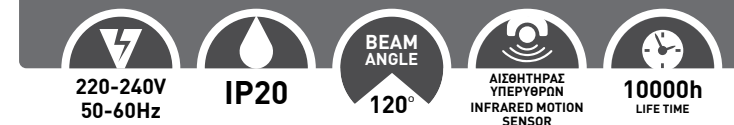

BARCODE	CODE	WATT	KELVIN	LUMEN	WEIGHT (Kgr):	mm	mm	mm	PACKING	PRICE (€)
5206139080691	145-15061	1W	2700K	60	0.067	50	105	20	1/10/100	2.95

• ΦΩΤΑΚΙ ΝΥΚΤΟΣ LED ΑΦΗΣ ΜΕ ΜΠΑΤΑΡΙΑ  
• LED BATTERIES NIGHT TOUCH LIGHT

• ΥΛΙΚΟ ΚΑΤΑΣΚΕΥΗΣ: • PRODUCTION MATERIAL: ABS



• Ιδανικό για φωτισμό κλειστών χώρων  
(ντουλάπα, έπιπλα κουζίνας, χώρους αποθήκευσης)  
• Ideal for indoor lighting  
(closet, kitchen furniture, storage areas)



BARCODE	CODE	WATT	KELVIN	LUMEN	WEIGHT (Kgr):	mm	mm	PACKING	PRICE (€)
5206139080783	145-15062	1W	2700K	60	0.097	30	80	1/10/40	2.75



- ΦΩΤΑΚΙ ΝΥΚΤΟΣ ΜΕ ΔΙΑΚΟΠΤΗ
- NIGHT LAMP WITH SWITCH

• ΥΛΙΚΟ ΚΑΤΑΣΚΕΥΗΣ: • PRODUCTION MATERIAL: **PBT PLASTIC**

Single  
Blister  
PACKING



BARCODE	CODE	WATT	BASEHOLDER	WEIGHT (Kgr):	mm	mm	PACKING	PRICE (€)
5206139000194	147-15050	max 5W	E14	0.079	115	35	1/10/100	2.95

- ΦΩΤΙΣΤΙΚΟ LED ΜΕ ΔΙΑΚΟΠΤΗ ΓΙΑ ΝΤΟΥΛΑΠΙΑ
- LED LIGHT WITH SWITCH FOR CUPBOARDS

• ΥΛΙΚΟ ΚΑΤΑΣΚΕΥΗΣ: • PRODUCTION MATERIAL: **PLASTIC**



4  
PCS



Double  
Blister  
PACKING

- Ιδανικό για ντουλάπια • Ideal for closets
- Συμπεριλαμβάνονται βίδες τοποθέτησης
- Included screws



BARCODE	CODE	WATT	WEIGHT (Kgr):	mm	mm	PACKING	PRICE (€)
5207227019562	145-15063	0.12W	0.088	50	25	1/25/100	4.95

- LED ΣΠΟΤ ΜΠΑΤΑΡΙΑΣ ΠΑΤΗΤΟ
- LED BATTERY SPOT WITH PUSH SWITCH

• ΥΛΙΚΟ ΚΑΤΑΣΚΕΥΗΣ: • PRODUCTION MATERIAL: **PLASTIC**



2  
PCS



Color  
Box  
PACKING

- Ιδανικό για φωτισμό κλειστών χώρων (ντουλάπια, έπιπλα κουζίνας, χώρους αποθήκευσης)
- Ideal for indoor lighting (closet, kitchen furniture, storage areas)



BARCODE	CODE	WATT	LUMEN	WEIGHT (Kgr):	mm	PACKING	PRICE (€)
5206139069443	147-55660	0.2W	15	0.073	25	1/10/100	2.85

# EUROLAMP®

Pioneers in New Technology !

QUALITY BRANDS

**EUROLAMP®**  
Electrical Equipment

**GACIA**  
by EUROLAMP®

**LINDNER**  
by EUROLAMP®

**Marlanvil**  
by EUROLAMP®

MCB



DL



RCBO



ILT



RCCB



**GACIA**  
by EUROLAMP®

- Υλικό Ράγας
- Din Rail Equipment

Discover our Collection ►





Η Ποιότητα  
και η Αξιοπιστία,  
είναι πλέον προσιτές !

Quality  
and Reliability,  
are now affordable!

**GACIA**  
by EUROLAMP®

**Pacemaker**  
of circuit breakers 

• ΠΙΣΤΟΠΟΙΗΜΕΝΗ ΠΟΙΟΤΗΤΑ • CERTIFIED QUALITY

ISO9001 ISO 14001 OHSAS 18001 SA8000





## MCB

- SWITCH SAFETY 1P 3KA
- ΑΥΤΟΜΑΤΑΚΙ ΜΟΝΟΠΟΛΙΚΟ 1P 3KA

**GACIA**  
EUROLAMP

PRODUCTION MATERIAL: **PLASTIC**  
ΥΛΙΚΟ ΚΑΤΑΣΚΕΥΗΣ: **ΠΛΑΣΤΙΚΟ**



BARCODE	CODE	FACTORY CODE	DESCRIPTION	↑ mm	↗ mm	↔ mm	PACKING	PRICE (€)
5207227009587	500-42300	SB6NZ	C 6A 1P 3KA	83	67	18	1/12/120	2.35
5207227009648	500-42301	SB6NZ	C 10A 1P 3KA	83	67	18	1/12/120	2.35
5207227009617	500-42302	SB6NZ	C 16A 1P 3KA	83	67	18	1/12/120	2.35
5207227009679	500-42303	SB6NZ	C 20A 1P 3KA	83	67	18	1/12/120	2.35
5207227009723	500-42304	SB6NZ	C 25A 1P 3KA	83	67	18	1/12/120	2.35
5207227009754	500-42305	SB6NZ	C 32A 1P 3KA	83	67	18	1/12/120	2.35
5207227009785	500-42306	SB6NZ	C 40A 1P 3KA	83	67	18	1/12/120	2.45
5207227009815	500-42307	SB6NZ	C 50A 1P 3KA	83	67	18	1/12/120	2.45
5207227009846	500-42308	SB6NZ	C 63A 1P 3KA	83	67	18	1/12/120	2.45



- SWITCH SAFETY 1P+N 3KA
- ΑΥΤΟΜΑΤΑΚΙ ΜΟΝΟΠΟΛΙΚΟ 1P+N 3KA

**GACIA**  
EUROLAMP

PRODUCTION MATERIAL: **PLASTIC**  
ΥΛΙΚΟ ΚΑΤΑΣΚΕΥΗΣ: **ΠΛΑΣΤΙΚΟ**



BARCODE	CODE	FACTORY CODE	DESCRIPTION	↑ mm	↗ mm	↔ mm	PACKING	PRICE (€)
5207227074837	500-42320	SN6N	C 2x6A 1P+N 3KA	83	77,5	17,8	1/12/120	5.35
5207227074844	500-42321	SN6N	C 2x10A 1P+N 3KA	83	77,5	17,8	1/12/120	5.35
5207227074851	500-42322	SN6N	C 2x16A 1P+N 3KA	83	77,5	17,8	1/12/120	5.35
5207227032202	500-42323	SN6N	C 2x20A 1P+N 3KA	83	77,5	17,8	1/12/120	5.35
5207227032219	500-42324	SN6N	C 2x25A 1P+N 3KA	83	77,5	17,8	1/12/120	5.35
5207227074868	500-42325	SN6N	C 2x32A 1P+N 3KA	83	77,5	17,8	1/12/120	5.35



## MCB

- SWITCH SAFETY 1P+N 3KA
- ΑΥΤΟΜΑΤΑΚΙ ΔΙΠΟΛΙΚΟ 1P+N 3KA

**GACIA**  
EUROLAMP

PRODUCTION MATERIAL: **PLASTIC**  
ΥΛΙΚΟ ΚΑΤΑΣΚΕΥΗΣ: **ΠΛΑΣΤΙΚΟ**



BARCODE	CODE	FACTORY CODE	DESCRIPTION	↑ mm	↗ mm	↔ mm	PACKING	PRICE (€)
5207227074875	500-42310	SB6NZ	C 2x6A 1P+N 3KA	83	67	36	1/6/60	4.25
5207227064685	500-42311	SB6NZ	C 2x10A 1P+N 3KA	83	67	36	1/6/60	4.25
5207227064715	500-42312	SB6NZ	C 2x16A 1P+N 3KA	83	67	36	1/6/60	4.25
5207227009877	500-42313	SB6NZ	C 2x20A 1P+N 3KA	83	67	36	1/6/60	4.25
5207227009907	500-42314	SB6NZ	C 2x25A 1P+N 3KA	83	67	36	1/6/60	4.25
5207227064746	500-42315	SB6NZ	C 2x32A 1P+N 3KA	83	67	36	1/6/60	4.25



- SWITCH SAFETY 1P 6KA
- ΑΥΤΟΜΑΤΑΚΙ ΜΟΝΟΠΟΛΙΚΟ 1P 6KA

**GACIA**  
EUROLAMP

PRODUCTION MATERIAL: **PLASTIC**  
ΥΛΙΚΟ ΚΑΤΑΣΚΕΥΗΣ: **ΠΛΑΣΤΙΚΟ**



BARCODE	CODE	FACTORY CODE	DESCRIPTION	↑ mm	↗ mm	↔ mm	PACKING	PRICE (€)
5206139092700	500-42017	M60H	C 3A 1P 6KA	83	67	18	1/12/120	2.58
5206139092762	500-42018	M60H	C 4A 1P 6KA	83	67	18	1/12/120	2.58
5206139280329	500-43000	SB6L	C 6A 1P 6KA	83	67	18	1/12/120	2.58
5206139280336	500-43001	SB6L	C 10A 1P 6KA	83	67	18	1/12/120	2.58
5206139280343	500-43002	SB6L	C 16A 1P 6KA	83	67	18	1/12/120	2.58
5206139280350	500-43003	SB6L	C 20A 1P 6KA	83	67	18	1/12/120	2.58
5206139280367	500-43004	SB6L	C 25A 1P 6KA	83	67	18	1/12/120	2.58
5206139280374	500-43005	SB6L	C 32A 1P 6KA	83	67	18	1/12/120	2.58
5206139280381	500-43006	SB6L	C 40A 1P 6KA	83	67	18	1/12/120	2.82
5207227074882	500-43007	SB6L	C 50A 1P 6KA	83	67	18	1/12/120	2.82
5206139280404	500-43008	SB6L	C 63A 1P 6KA	83	67	18	1/12/120	2.82



**GACIA**  
by EUROLAMP

### MCB

- SWITCH SAFETY 2P 6KA
- ΑΥΤΟΜΑΤΑΚΙ ΔΙΠΟΛΙΚΟ 2P 6KA

PRODUCTION MATERIAL: **POLYAMIDE**  
ΥΛΙΚΟ ΚΑΤΑΣΚΕΥΗΣ: **ΠΟΛΥΑΜΙΔΙΟ**



BARCODE	CODE	FACTORY CODE	DESCRIPTION	↑ mm	↗ mm	↔ mm	PACKING	PRICE (€)
5207227070242	500-43010	SB6L	C 6A 2P 6KA	83	67	35	1/6/60	5.55
5207227074899	500-43011	SB6L	C 10A 2P 6KA	83	67	35	1/6/60	5.55
5207227070273	500-43012	SB6L	C 16A 2P 6KA	83	67	35	1/6/60	5.55
5207227070303	500-43013	SB6L	C 20A 2P 6KA	83	67	35	1/6/60	5.55
5207227074929	500-43014	SB6L	C 25A 2P 6KA	83	67	35	1/6/60	5.55
5207227070334	500-43015	SB6L	C 32A 2P 6KA	83	67	35	1/6/60	5.55
5207227070365	500-43016	SB6L	C 40A 2P 6KA	83	67	36	1/6/60	5.95
5207227070396	500-43017	SB6L	C 50A 2P 6KA	83	67	35	1/6/60	5.95
5207227070426	500-43018	SB6L	C 63A 2P 6KA	83	67	35	1/6/60	5.95



**GACIA**  
by EUROLAMP

- SWITCH SAFETY 3P 6KA
- ΑΥΤΟΜΑΤΑΚΙ ΤΡΙΠΟΛΙΚΟ 3P 6KA

PRODUCTION MATERIAL: **POLYAMIDE**  
ΥΛΙΚΟ ΚΑΤΑΣΚΕΥΗΣ: **ΠΟΛΥΑΜΙΔΙΟ**



BARCODE	CODE	FACTORY CODE	DESCRIPTION	↑ mm	↗ mm	↔ mm	PACKING	PRICE (€)
5207227074936	500-43020	SB6L	C 6A 3P 6KA	83	67	54	1/4/40	7.95
5207227074943	500-43021	SB6L	C 10A 3P 6KA	83	67	54	1/4/40	7.95
5207227074950	500-43022	SB6L	C 16A 3P 6KA	83	67	54	1/4/40	7.95
5207227074967	500-43023	SB6L	C 20A 3P 6KA	83	67	54	1/4/40	7.95
5207227074974	500-43024	SB6L	C 25A 3P 6KA	83	67	54	1/4/40	7.95
5207227074998	500-43025	SB6L	C 32A 3P 6KA	83	67	54	1/4/40	7.95
5207227075018	500-43026	SB6L	C 40A 3P 6KA	83	67	54	1/4/40	8.75
5207227075025	500-43027	SB6L	C 50A 3P 6KA	83	67	54	1/4/40	8.75
5206139280435	500-43028	SB6L	C 63A 3P 6KA	83	67	54	1/4/40	8.75



**GACIA**  
by EUROLAMP

### MCB

- SWITCH SAFETY 4P 6KA
- ΑΥΤΟΜΑΤΑΚΙ ΤΕΤΡΑΠΟΛΙΚΟ 4P 6KA

PRODUCTION MATERIAL: **POLYAMIDE**  
ΥΛΙΚΟ ΚΑΤΑΣΚΕΥΗΣ: **ΠΟΛΥΑΜΙΔΙΟ**



BARCODE	CODE	FACTORY CODE	DESCRIPTION	↑ mm	↗ mm	↔ mm	PACKING	PRICE (€)
5207227075049	500-43030	SB6L	C 6A 4P 6KA	83	67	70	1/3/30	11.65
5207227075063	500-43031	SB6L	C 10A 4P 6KA	83	67	70	1/3/30	11.65
5207227075070	500-43032	SB6L	C 16A 4P 6KA	83	67	70	1/3/30	11.65
5207227075087	500-43033	SB6L	C 20A 4P 6KA	83	67	70	1/3/30	11.65
5207227075094	500-43034	SB6L	C 25A 4P 6KA	83	67	70	1/3/30	11.65
5207227075100	500-43035	SB6L	C 32A 4P 6KA	83	67	70	1/3/30	11.65
5207227075117	500-43036	SB6L	C 40A 4P 6KA	83	67	70	1/3/30	12.90
5207227075124	500-43037	SB6L	C 50A 4P 6KA	83	67	70	1/3/30	12.90
5207227075131	500-43038	SB6L	C 63A 4P 6KA	83	67	70	1/3/30	12.90



**GACIA**  
by EUROLAMP

- SWITCH SAFETY 1P+N 10KA
- ΑΥΤΟΜΑΤΑΚΙ ΜΟΝΟΠΟΛΙΚΟ 1P+N 10KA

BARCODE	CODE	FACTORY CODE	DESCRIPTION	↑ mm	↗ mm	↔ mm	PACKING	PRICE (€)
5207227070457	500-43300	PB8H	C 20A 1P+N 10KA	87	77,5	35	1/6/60	7.95
5207227070488	500-43301	PB8H	C 32A 1P+N 10KA	87	77,5	35	1/6/60	7.95
5207227070518	500-43302	PB8H	C 40A 1P+N 10KA	87	77,5	35	1/6/60	9.15
5207227070549	500-43303	PB8H	C 63A 1P+N 10KA	87	77,5	35	1/6/60	9.15



**GACIA**  
by EUROLAMP

- SWITCH SAFETY 3P+N 10KA
- ΑΥΤΟΜΑΤΑΚΙ ΤΕΤΡΑΠΟΛΙΚΟ 3P+N 10KA

BARCODE	CODE	FACTORY CODE	DESCRIPTION	↑ mm	↗ mm	↔ mm	PACKING	PRICE (€)
5207227070570	500-43310	PB8H	C 20A 3P+N 10KA	87	77,5	70	1/3/30	14.65
5207227070600	500-43311	PB8H	C 32A 3P+N 10KA	87	77,5	70	1/3/30	14.65
5207227070631	500-43312	PB8H	C 40A 3P+N 10KA	87	77,5	70	1/3/30	16.65
5207227070662	500-43313	PB8H	C 63A 3P+N 10KA	87	77,5	70	1/3/30	16.65



### ILT

- SINGLE RAIL LAMPS 1/2P
- ΕΝΔΕΙΚΤΙΚΕΣ ΛΥΧΝΙΕΣ ΡΑΓΑΣ 1/2P

**GACIA**  
by EUROLAMP

PRODUCTION MATERIAL: **PLASTIC**  
ΥΛΙΚΟ ΚΑΤΑΣΚΕΥΗΣ: **ΠΛΑΣΤΙΚΟ**

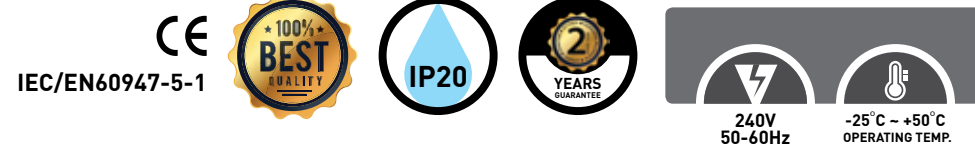

BARCODE	CODE	FACTORY CODE	DESCRIPTION	↑ mm	↗ mm	↖ mm	↔	PACKING	PRICE (€)
5206139009937	500-39001	L60T	ΚΟΚΚΙΝΗ / RED	80	62,4	8,8	1/24/240	2.75	
5206139065414	500-39002	L60T	ΠΡΑΣΙΝΗ / GREEN	80	62,4	8,8	1/24/240	2.75	
5206139065421	500-39003	L60T	ΜΠΛΕ / BLUE	80	62,4	8,8	1/24/240	2.75	

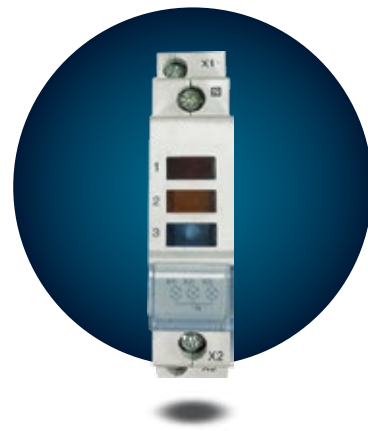

- SINGLE RAIL LAMP 1P
- ΕΝΔΕΙΚΤΙΚΗ ΛΥΧΝΙΑ ΡΑΓΑΣ 1P

**GACIA**  
by EUROLAMP

PRODUCTION MATERIAL: **PLASTIC**  
ΥΛΙΚΟ ΚΑΤΑΣΚΕΥΗΣ: **ΠΛΑΣΤΙΚΟ**



BARCODE	CODE	FACTORY CODE	DESCRIPTION	↑ mm	↗ mm	↖ mm	↔	PACKING	PRICE (€)
5207227030277	500-39005	BX9D-S	ΤΡΙΦΑΣΙΚΗ LED MODULAR 3 PHASE LED	81	89	18	1/12/240	5.18	



### DL

- GENERAL SWITCHES 1P
- ΡΑΓΟΔΙΑΚΟΠΤΕΣ ΜΟΝΟΠΟΛΙΚΟΙ 1P

**GACIA**  
by EUROLAMP

PRODUCTION MATERIAL: **PLASTIC**  
ΥΛΙΚΟ ΚΑΤΑΣΚΕΥΗΣ: **ΠΛΑΣΤΙΚΟ**



BARCODE	CODE	FACTORY CODE	DESCRIPTION	↑ mm	↗ mm	↖ mm	↔	PACKING	PRICE (€)
5207227065163	500-43600	DL	1x25A 1P	83	67	18	1/12/120	2.95	
5206139280251	500-43601	DL	1x40A 1P	83	67	18	1/12/120	2.95	
5206139280459	500-43602	DL	1x63A 1P	83	67	18	1/12/120	2.95	



### DL

- GENERAL SWITCHES 2P
- ΡΑΓΟΔΙΑΚΟΠΤΕΣ ΔΙΠΟΛΙΚΟΙ 2P

**GACIA**  
by EUROLAMP

PRODUCTION MATERIAL: **PLASTIC**  
ΥΛΙΚΟ ΚΑΤΑΣΚΕΥΗΣ: **ΠΛΑΣΤΙΚΟ**



BARCODE	CODE	FACTORY CODE	DESCRIPTION	↑ mm	↗ mm	↖ mm	↔	PACKING	PRICE (€)
5207227065194	500-43603	DL	2x25A 2P	83	67	36	1/6/60	6.25	
5206139280442	500-43604	DL	2x40A 2P	83	67	36	1/6/60	6.25	
5206139280466	500-43605	DL	2x63A 2P	83	67	36	1/6/60	6.25	



- GENERAL SWITCHES 3P
- ΡΑΓΟΔΙΑΚΟΠΤΕΣ ΤΡΙΠΟΛΙΚΟΙ 3P

**GACIA**  
by EUROLAMP

PRODUCTION MATERIAL: **PLASTIC**  
ΥΛΙΚΟ ΚΑΤΑΣΚΕΥΗΣ: **ΠΛΑΣΤΙΚΟ**



BARCODE	CODE	FACTORY CODE	DESCRIPTION	↑ mm	↗ mm	↖ mm	↔	PACKING	PRICE (€)
5206139280268	500-43606	DL	3x40A 3P	83	67	54	1/4/40	9.85	
5206139280275	500-43607	DL	3x63A 3P	83	67	54	1/4/40	9.85	
5206139022097	500-43608	DL	3x80A 3P	83	67	54	1/4/40	10.35	
5207227065224	500-43609	DL	3x100A 3P	83	67	54	1/4/40	10.35	
5207227065255	500-43610	DL	3x125A 3P	83	67	54	1/4/40	10.35	



- GENERAL SWITCHES 4P
- ΡΑΓΟΔΙΑΚΟΠΤΕΣ ΤΕΤΡΑΠΟΛΙΚΟΙ 4P

**GACIA**  
by EUROLAMP

PRODUCTION MATERIAL: **PLASTIC**  
ΥΛΙΚΟ ΚΑΤΑΣΚΕΥΗΣ: **ΠΛΑΣΤΙΚΟ**



BARCODE	CODE	FACTORY CODE	DESCRIPTION	↑ mm	↗ mm	↖ mm	↔	PACKING	PRICE (€)
5207227076107	500-43611	DL	4x40A 4P	83	67	72	1/3/30	10.35	
5206139022158	500-43612	DL	4x63A 4P	83	67	72	1/3/30	12.85	
5207227072932	500-43613	DL	4x80A 4P	83	67	72	1/3/30	12.85	
5207227065286	500-43614	DL	4x100A 4P	83	67	72	1/3/30	14.95	
5207227065316	500-43615	DL	4x125A 4P	83	67	72	1/3/30	14.95	

**GACIA**  
EUROLAMP



## RCBO

- SWITCH 1 POLE 1P+N 4,5KA TYPE AC
- ΡΕΛΕ ΜΟΝΟΠΟΛΙΚΟ 1P+N 4,5KA ΤΥΠΟΥ AC

PRODUCTION MATERIAL: **POLYAMIDE** / PROTECTION TYPE: **ELECTRONIC**  
ΥΛΙΚΟ ΚΑΤΑΣΚΕΥΗΣ: **ΠΟΛΥΑΜΙΔΙΟ** / ΤΥΠΟΣ ΠΡΟΣΤΑΣΙΑΣ: **ΗΛΕΚΤΡΟΝΙΚΟΣ**



BARCODE	CODE	FACTORY CODE	DESCRIPTION	mm	mm	mm	PACKING	PRICE (€)
5207227070150	500-43510	PL8NT	AC 6A 4,5KA 30mA 1P+N	81	77,5	18	1/12/120	17.45
5207227064951	500-43511	PL8NT	AC 10A 4,5KA 30mA 1P+N	81	77,5	18	1/12/120	17.45
5207227064982	500-43512	PL8NT	AC 16A 4,5KA 30mA 1P+N	81	77,5	18	1/12/120	17.45
5207227065019	500-43513	PL8NT	AC 20A 4,5KA 30mA 1P+N	81	77,5	18	1/12/120	17.45
5207227065040	500-43514	PL8NT	AC 25A 4,5KA 30mA 1P+N	81	77,5	18	1/12/120	17.45
5207227065071	500-43515	PL8NT	AC 32A 4,5KA 30mA 1P+N	81	77,5	18	1/12/120	17.45
5207227075148	500-43516	PL8NT	AC 40A 4,5KA 30mA 1P+N	87	77,5	18	1/12/120	17.45

**GACIA**  
EUROLAMP



## RCBO

- SWITCH 1 POLE 1P+N 6KA TYPE AC
- ΡΕΛΕ ΜΟΝΟΠΟΛΙΚΟ 1P+N 6KA ΤΥΠΟΥ AC

PRODUCTION MATERIAL: **POLYAMIDE** / PROTECTION TYPE: **ELECTRONIC**  
ΥΛΙΚΟ ΚΑΤΑΣΚΕΥΗΣ: **ΠΟΛΥΑΜΙΔΙΟ** / ΤΥΠΟΣ ΠΡΟΣΤΑΣΙΑΣ: **ΗΛΕΚΤΡΟΝΙΚΟΣ**



BARCODE	CODE	FACTORY CODE	DESCRIPTION	mm	mm	mm	PACKING	PRICE (€)
5207227070877	500-43530	PL8HT	AC 6A 6KA 30mA 1P+N	82	72	18	1/12/120	23.55
5207227070907	500-43531	PL8HT	AC 10A 6KA 30mA 1P+N	82	72	18	1/12/120	23.55
5207227070938	500-43532	PL8HT	AC 16A 6KA 30mA 1P+N	82	72	18	1/12/120	23.55
5207227070969	500-43533	PL8HT	AC 20A 6KA 30mA 1P+N	82	72	18	1/12/120	23.55
5207227070990	500-43534	PL8HT	AC 25A 6KA 30mA 1P+N	82	72	18	1/12/120	23.55
5207227071027	500-43535	PL8HT	AC 32A 6KA 30mA 1P+N	82	72	18	1/12/120	23.55
5207227075162	500-43536	PL8HT	AC 40A 6KA 30mA 1P+N	82	72	18	1/12/120	23.55

**GACIA**  
EUROLAMP



- SWITCH 2 POLES 1P+N 4,5KA TYPE AC
- ΡΕΛΕ ΔΙΠΟΛΙΚΟ 1P+N 4,5KA ΤΥΠΟΥ AC

PRODUCTION MATERIAL: **POLYAMIDE** / PROTECTION TYPE: **ELECTRONIC**  
ΥΛΙΚΟ ΚΑΤΑΣΚΕΥΗΣ: **ΠΟΛΥΑΜΙΔΙΟ** / ΤΥΠΟΣ ΠΡΟΣΤΑΣΙΑΣ: **ΗΛΕΚΤΡΟΝΙΚΟΣ**



BARCODE	CODE	FACTORY CODE	DESCRIPTION	mm	mm	mm	PACKING	PRICE (€)
5207227064777	500-43500	SL6N	AC 6A 4,5KA 30mA 1P+N	80	75	35	1/6/60	12.15
5207227064807	500-43501	SL6N	AC 10A 4,5KA 30mA 1P+N	80	75	35	1/6/60	12.15
5207227064838	500-43502	SL6N	AC 16A 4,5KA 30mA 1P+N	80	75	35	1/6/60	12.15
5207227064869	500-43503	SL6N	AC 20A 4,5KA 30mA 1P+N	80	75	35	1/6/60	12.15
5207227064890	500-43504	SL6N	AC 25A 4,5KA 30mA 1P+N	80	75	35	1/6/60	12.15
5207227064920	500-43505	SL6N	AC 32A 4,5KA 30mA 1P+N	80	75	35	1/6/60	12.15
5207227075155	500-43506	SL6N	AC 40A 4,5KA 30mA 1P+N	80	75	35	1/6/60	12.15

**GACIA**  
EUROLAMP



- SWITCH 2 POLES 1P+N 6KA TYPE AC
- ΡΕΛΕ ΔΙΠΟΛΙΚΟ 1P+N 6KA ΤΥΠΟΥ AC

PRODUCTION MATERIAL: **POLYAMIDE** / PROTECTION TYPE: **ELECTRONIC**  
ΥΛΙΚΟ ΚΑΤΑΣΚΕΥΗΣ: **ΠΟΛΥΑΜΙΔΙΟ** / ΤΥΠΟΣ ΠΡΟΣΤΑΣΙΑΣ: **ΗΛΕΚΤΡΟΝΙΚΟΣ**



BARCODE	CODE	FACTORY CODE	DESCRIPTION	mm	mm	mm	PACKING	PRICE (€)
5207227070693	500-43520	PL8HE	AC 6A 6KA 30mA 1P+N	81	77,5	36	1/6/60	18.15
5207227070723	500-43521	PL8HE	AC 10A 6KA 30mA 1P+N	81	77,5	36	1/6/60	18.15
5207227070754	500-43522	PL8HE	AC 16A 6KA 30mA 1P+N	81	77,5	36	1/6/60	18.15
5207227070785	500-43523	PL8HE	AC 20A 6KA 30mA 1P+N	81	77,5	36	1/6/60	18.15
5207227070815	500-43524	PL8HE	AC 25A 6KA 30mA 1P+N	81	77,5	36	1/6/60	18.15
5207227070846	500-43525	PL8HE	AC 32A 6KA 30mA 1P+N	81	77,5	36	1/6/60	18.15
5207227075186	500-43526	PL8HE	AC 40A 6KA 30mA 1P+N	81	77,5	36	1/6/60	18.15

**GACIA**  
by EUROLAMP



**RCBO**

- SWITCH 1 POLE 1P+N 6KA TYPE B
- ΡΕΛΕ ΜΟΝΟΠΟΛΙΚΟ 1P+N 6KA ΤΥΠΟΥ Β

PRODUCTION MATERIAL: **POLYAMIDE** / PROTECTION TYPE: **ELECTRONIC**  
ΥΛΙΚΟ ΚΑΤΑΣΚΕΥΗΣ: **ΠΟΛΥΑΜΙΔΙΟ** / ΤΥΠΟΣ ΠΡΟΣΤΑΣΙΑΣ: **ΗΛΕΚΤΡΟΝΙΚΟΣ**

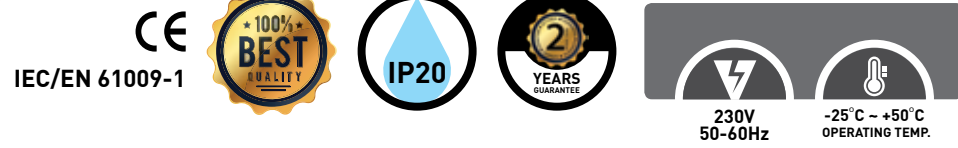

BARCODE	CODE	FACTORY CODE	DESCRIPTION	↑ mm	↗ mm	↔ mm	PACKING	PRICE (€)
5207227071232	500-43550	PL8HT	B 6A 6KA 30mA 1P+N	82	72	18	1/12/120	23.55
5207227071263	500-43551	PL8HT	B 10A 6KA 30mA 1P+N	82	72	18	1/12/120	23.55
5207227071294	500-43552	PL8HT	B 16A 6KA 30mA 1P+N	82	72	18	1/12/120	23.55
5207227071324	500-43553	PL8HT	B 20A 6KA 30mA 1P+N	82	72	18	1/12/120	23.55
5207227071355	500-43554	PL8HT	B 25A 6KA 30mA 1P+N	82	72	18	1/12/120	23.55
5207227071386	500-43555	PL8HT	B 32A 6KA 30mA 1P+N	82	72	18	1/12/120	23.55
5207227075193	500-43556	PL8HT	B 40A 6KA 30mA 1P+N	82	72	18	1/12/120	23.55

**GACIA**  
by EUROLAMP



**RCCB**

- SWITCH 2 POLES 1P+N 6KA TYPE B
- ΡΕΛΕ ΔΙΠΟΛΙΚΟ 1P+N 6KA ΤΥΠΟΥ Β

PRODUCTION MATERIAL: **POLYAMIDE** / PROTECTION TYPE: **ELECTRONIC**  
ΥΛΙΚΟ ΚΑΤΑΣΚΕΥΗΣ: **ΠΟΛΥΑΜΙΔΙΟ** / ΤΥΠΟΣ ΠΡΟΣΤΑΣΙΑΣ: **ΗΛΕΚΤΡΟΝΙΚΟΣ**



BARCODE	CODE	FACTORY CODE	DESCRIPTION	↑ mm	↗ mm	↔ mm	PACKING	PRICE (€)
5207227071058	500-43540	PL8HE	B 6A 6KA 30mA 1P+N	81	77,5	36	1/6/60	18.15
5207227071089	500-43541	PL8HE	B 10A 6KA 30mA 1P+N	81	77,5	36	1/6/60	18.15
5207227071119	500-43542	PL8HE	B 16A 6KA 30mA 1P+N	81	77,5	36	1/6/60	18.15
5207227071140	500-43543	PL8HE	B 20A 6KA 30mA 1P+N	81	77,5	36	1/6/60	18.15
5207227071171	500-43544	PL8HE	B 25A 6KA 30mA 1P+N	81	77,5	36	1/6/60	18.15
5207227071201	500-43545	PL8HE	B 32A 6KA 30mA 1P+N	81	77,5	36	1/6/60	18.15
5207227075209	500-43546	PL8HE	B 40A 6KA 30mA 1P+N	81	77,5	36	1/6/60	18.15

**GACIA**  
by EUROLAMP



**SHOCK RELAY 30mA TYPE AC**  
**ΡΕΛΕ ΔΙΑΡΡΟΗΣ 30mA ΤΥΠΟΥ AC**

PRODUCTION MATERIAL: **PLASTIC** / PROTECTION TYPE: **ELECTROMAGNETIC**  
ΥΛΙΚΟ ΚΑΤΑΣΚΕΥΗΣ: **ΠΛΑΣΤΙΚΟ** / ΤΥΠΟΣ ΠΡΟΣΤΑΣΙΑΣ: **ΗΛΕΚΤΡΟΜΑΓΝΗΤΙΚΟΣ**  
**\*ELECTRONIC/ ΗΛΕΚΤΡΟΝΙΚΟΣ**



BARCODE	CODE	FACTORY CODE	DESCRIPTION	↑ mm	↗ mm	↔ mm	PACKING	PRICE (€)
5207227032196	500-37005 *	PL8NT	AC 1P 2x25A 6KA 30mA 230V	87	77,5	17,7	1/12/120	29.80
5206139280046	500-37000	SR6HM	AC 2P 2X40A 6KA 30mA 230V	81	77,5	35	1/6/60	18.45
5206139280053	500-37001	SR6HM	AC 2P 2X63A 6KA 30mA 230V	81	77,5	35	1/6/60	18.45
5206139280060	500-37002	SR6HM	AC 4P 4X40A 6KA 30mA 400V	81	77,5	70	1/3/30	23.55
5206139280077	500-37003	SR6HM	AC 4P 4X63A 6KA 30mA 400V	81	77,5	70	1/3/30	23.55
5206139082084	500-37004	SR6HM	AC 2P 2x25A 6KA 30mA 230V	81	77,5	35	1/6/60	17.45

Σημείο ροής 3.0Nm. Χρησιμοποιήστε ηλεκτρικό κατσαβίδι για γρήγορη εγκατάσταση. Torque reaches 3.0N-m, use electric screwdriver to achieve quick installation.

Παράθυρο ένδειξης διαρροής  
Κόκκινο: Βλάβη διαρροής  
Λευκό: Κανονική λειτουργία / κλειστό  
**Leakage Indication**  
Red: Leakage fault  
White: Work normally / switch off

Τύπος / Type: A, AC, AC+S

Υποστήριξη επάνω και κάτω για εισερχόμενη καλωδίωση  
Support top incoming wiring and bottom incoming wiring

Κουμπι test  
Test button

Σύμβολο πιστοποίησης  
Certification mark

50/60Hz  
AC  
0.15



### RCCB

- SHOCK RELAY 30mA TYPE A
- ΡΕΛΕ ΔΙΑΡΡΟΗΣ 30mA ΤΥΠΟΥ A

PRODUCTION MATERIAL: **PLASTIC** / PROTECTION TYPE: **ELECTROMAGNETIC**  
 ΥΛΙΚΟ ΚΑΤΑΣΚΕΥΗΣ: **ΠΛΑΣΤΙΚΟ** / ΤΥΠΟΣ ΠΡΟΣΤΑΣΙΑΣ: **ΗΛΕΚΤΡΟΜΑΓΝΗΤΙΚΟΣ**



BARCODE	CODE	FACTORY CODE	DESCRIPTION	mm	mm	mm	PACKING	PRICE (€)
5206139037039	500-37020	SR6HM	A 2P 2x25A 6KA 30mA	81	77,5	35	1/6/60	31.60
5207227020438	500-37021	SR6HM	A 2P 2x40A 6KA 30mA	81	77,5	35	1/6/60	31.60
5206139037046	500-37022	SR6HM	A 2P 2x63A 6KA 30mA	81	77,5	35	1/6/60	31.60



PRODUCTION MATERIAL: **PLASTIC** / PROTECTION TYPE: **ELECTROMAGNETIC**  
 ΥΛΙΚΟ ΚΑΤΑΣΚΕΥΗΣ: **ΠΛΑΣΤΙΚΟ** / ΤΥΠΟΣ ΠΡΟΣΤΑΣΙΑΣ: **ΗΛΕΚΤΡΟΜΑΓΝΗΤΙΚΟΣ**



BARCODE	CODE	FACTORY CODE	DESCRIPTION	mm	mm	mm	PACKING	PRICE (€)
5206139037060	500-37023	SR6HM	A 4P 4x40A 6KA 30mA	81	77,5	70	1/3/30	38.95
5207227020483	500-37024	SR6HM	A 4P 4x63A 6KA 30mA	81	77,5	70	1/3/30	38.95



- SHOCK RELAY 300mA TYPE AC
- ΡΕΛΕ ΔΙΑΡΡΟΗΣ 300mA ΤΥΠΟΥ AC

PRODUCTION MATERIAL: **PLASTIC** / PROTECTION TYPE: **ELECTROMAGNETIC**  
 ΥΛΙΚΟ ΚΑΤΑΣΚΕΥΗΣ: **ΠΛΑΣΤΙΚΟ** / ΤΥΠΟΣ ΠΡΟΣΤΑΣΙΑΣ: **ΗΛΕΚΤΡΟΜΑΓΝΗΤΙΚΟΣ**



BARCODE	CODE	FACTORY CODE	DESCRIPTION	mm	mm	mm	PACKING	PRICE (€)
5206139092588	500-37010	SR6HM	AC 2P 2x40A 6KA 300mA 230V	81	77,5	35	1/6/60	18.85
5206139092649	500-37012	SR6HM	AC 4P 4x40A 6KA 300mA 400V	81	77,5	70	1/3/30	24.25
5206139037770	500-37013	SR6HM	AC 4P 4x63A 6KA 300mA 400V	81	77,5	70	1/3/30	24.25



### RCCB

- SHOCK RELAY 30mA TYPE A
- ΡΕΛΕ ΔΙΑΡΡΟΗΣ 30mA ΤΥΠΟΥ A

PRODUCTION MATERIAL: **POLYAMIDE** / PROTECTION TYPE: **ELECTRONIC**  
 ΥΛΙΚΟ ΚΑΤΑΣΚΕΥΗΣ: **ΠΟΛΥΑΜΙΔΙΟ** / ΤΥΠΟΣ ΠΡΟΣΤΑΣΙΑΣ: **ΗΛΕΚΤΡΟΝΙΚΟΣ**



BARCODE	CODE	FACTORY CODE	DESCRIPTION	mm	mm	mm	PACKING	PRICE (€)
5207227071416	500-37500	PR8NE	A 2P 2x25A 6KA 30mA	81	74	36	1/6/60	19.25
5207227075216	500-37501	PR8NE	A 2P 2x32A 6KA 30mA	81	74	36	1/6/60	19.25
5207227071447	500-37502	PR8NE	A 2P 2x40A 6KA 30mA	81	74	36	1/6/60	19.25
5207227071478	500-37503	PR8NE	A 2P 2x63A 6KA 30mA	81	74	36	1/6/60	19.25



PRODUCTION MATERIAL: **POLYAMIDE** / PROTECTION TYPE: **ELECTRONIC**  
 ΥΛΙΚΟ ΚΑΤΑΣΚΕΥΗΣ: **ΠΟΛΥΑΜΙΔΙΟ** / ΤΥΠΟΣ ΠΡΟΣΤΑΣΙΑΣ: **ΗΛΕΚΤΡΟΝΙΚΟΣ**



BARCODE	CODE	FACTORY CODE	DESCRIPTION	mm	mm	mm	PACKING	PRICE (€)
5207227071508	500-37510	PR8NE	A 4P 4x25A 6KA 30mA	81	74	72	1/3/30	25.90
5207227071539	500-37511	PR8NE	A 4P 4x32A 6KA 30mA	81	74	72	1/3/30	25.90
5207227071560	500-37512	PR8NE	A 4P 4x40A 6KA 30mA	81	74	72	1/3/30	25.90
5207227071591	500-37513	PR8NE	A 4P 4x63A 6KA 30mA	81	74	72	1/3/30	25.90
5207227065101	500-37514	PR8NE	A 4P 4x80A 6KA 30mA	81	74	72	1/3/30	29.60
5207227065132	500-37515	PR8NE	A 4P 4x100A 6KA 30mA	81	74	72	1/3/30	29.60



- SHOCK RELAY 300mA TYPE A
- ΡΕΛΕ ΔΙΑΡΡΟΗΣ 300mA ΤΥΠΟΥ A

PRODUCTION MATERIAL: **POLYAMIDE** / PROTECTION TYPE: **ELECTRONIC**  
 ΥΛΙΚΟ ΚΑΤΑΣΚΕΥΗΣ: **ΠΟΛΥΑΜΙΔΙΟ** / ΤΥΠΟΣ ΠΡΟΣΤΑΣΙΑΣ: **ΗΛΕΚΤΡΟΝΙΚΟΣ**



BARCODE	CODE	FACTORY CODE	DESCRIPTION	mm	mm	mm	PACKING	PRICE (€)
5207227071621	500-37520	PR8NE	A 2P 2x25A 6KA 300mA	81	74	36	1/6/60	21.20
5207227071652	500-37521	PR8NE	A 2P 2x32A 6KA 300mA	81	74	36	1/6/60	21.20
5207227071683	500-37522	PR8NE	A 2P 2x40A 6KA 300mA	81	74	36	1/6/60	21.20
5207227071713	500-37523	PR8NE	A 2P 2x63A 6KA 300mA	81	74	36	1/6/60	21.20



## RCCB



- SHOCK RELAY 300mA TYPE A
- ΡΕΛΕ ΔΙΑΡΡΟΗΣ 300mA ΤΥΠΟΥ A

PRODUCTION MATERIAL: **POLYAMIDE** / PROTECTION TYPE: **ELECTRONIC**  
 ΥΛΙΚΟ ΚΑΤΑΣΚΕΥΗΣ: **ΠΟΛΥΑΜΙΔΙΟ** / ΤΥΠΟΣ ΠΡΟΣΤΑΣΙΑΣ: **ΗΛΕΚΤΡΟΝΙΚΟΣ**



BARCODE	CODE	FACTORY CODE	DESCRIPTION	mm	mm	mm	PACKING	PRICE (€)
5207227071744	500-37530	PR8NE	A 4P 4x25A 6KA 300mA	81	74	72	1/3/30	27.75
5207227071775	500-37531	PR8NE	A 4P 4x32A 6KA 300mA	81	74	72	1/3/30	27.75
5207227071805	500-37532	PR8NE	A 4P 4x40A 6KA 300mA	81	74	72	1/3/30	27.75
5207227071836	500-37533	PR8NE	A 4P 4x63A 6KA 300mA	81	74	72	1/3/30	27.75
5207227075223	500-37534	PR8NE	A 4P 4x80A 6KA 300mA	81	74	72	1/3/30	30.25
5207227075230	500-37535	PR8NE	A 4P 4x100A 6KA 300mA	81	74	72	1/3/30	30.25



- SHOCK RELAY 300mA TYPE AC+S
- ΡΕΛΕ ΔΙΑΡΡΟΗΣ 300mA ΤΥΠΟΥ AC+S

PRODUCTION MATERIAL: **POLYAMIDE** / PROTECTION TYPE: **ELECTRONIC**  
 ΥΛΙΚΟ ΚΑΤΑΣΚΕΥΗΣ: **ΠΟΛΥΑΜΙΔΙΟ** / ΤΥΠΟΣ ΠΡΟΣΤΑΣΙΑΣ: **ΗΛΕΚΤΡΟΝΙΚΟΣ**



BARCODE	CODE	FACTORY CODE	DESCRIPTION	mm	mm	mm	PACKING	PRICE (€)
5207227075247	500-37540	PR8HE	AC+S 2P 2x63A 10KA 300mA	81	74	36	1/6/60	24.60



PRODUCTION MATERIAL: **POLYAMIDE**  
 PROTECTION TYPE: **ELECTRONIC**

ΥΛΙΚΟ ΚΑΤΑΣΚΕΥΗΣ: **ΠΟΛΥΑΜΙΔΙΟ**  
 ΤΥΠΟΣ ΠΡΟΣΤΑΣΙΑΣ: **ΗΛΕΚΤΡΟΝΙΚΟΣ**



BARCODE	CODE	FACTORY CODE	DESCRIPTION	mm	mm	mm	PACKING	PRICE (€)
5207227075254	500-37545	PR8HE	AC+S 4P 4x63A 10KA 300mA	81	74	72	1/3/30	31.20



## HC

- INSTALLATION CONTACTORS 240V
- ΡΕΛΕ ΙΣΧΥΟΣ ΡΑΓΑΣ 240V

PRODUCTION MATERIAL: **PLASTIC**  
 ΥΛΙΚΟ ΚΑΤΑΣΚΕΥΗΣ: **ΠΛΑΣΤΙΚΟ**



BARCODE	CODE	FACTORY CODE	DESCRIPTION	mm	mm	mm	PACKING	PRICE (€)
5206139280084	500-37100	HC	2X20A 2NO 2P AC	90,5	62,5	18	1/6/60	13.65
5206139096876	500-37101	HC	2X40A 2NO 2P AC	90,5	62,5	36	1/6/60	23.85
5206139096883	500-37102	HC	2X63A 2NO 2P AC	90,5	62,5	36	1/6/60	23.85
5206139280091	500-37110	HC	4X25A 4NO 4P AC	90,5	62,5	36	1/4/40	24.65
5206139022059	500-37111	HC	4X40A 4NO 4P AC	90,5	62,5	54	1/4/40	32.60
5206139096890	500-37112	HC	4X63A 4NO 4P AC	90,5	62,5	54	1/4/40	32.60



- INSTALLATION CONTACTORS 24V
- ΡΕΛΕ ΙΣΧΥΟΣ ΡΑΓΑΣ 24V

PRODUCTION MATERIAL: **PLASTIC**  
 ΥΛΙΚΟ ΚΑΤΑΣΚΕΥΗΣ: **ΠΛΑΣΤΙΚΟ**



BARCODE	CODE	FACTORY CODE	DESCRIPTION	mm	mm	mm	PACKING	PRICE (€)
5207227065347	500-37120	HC	2X25A 2NO 2P AC	90,5	62,5	18	1/6/60	13.65
5207227065378	500-37121	HC	2X40A 2NO 2P AC	90,5	62,5	36	1/6/60	23.85
5207227065408	500-37122	HC	2X63A 2NO 2P AC	90,5	62,5	36	1/6/60	23.85
5207227065439	500-37123	HC	4X25A 4NO 4P AC	90,5	62,5	36	1/4/40	24.65
5207227065460	500-37124	HC	4X40A 4NO 4P AC	90,5	62,5	54	1/4/40	32.60
5207227065491	500-37125	HC	4X63A 4NO 4P AC	90,5	62,5	54	1/4/40	32.60



• COPPER BUSBARS • ΓΕΦΥΡΕΣ ΧΑΛΚΟΥ

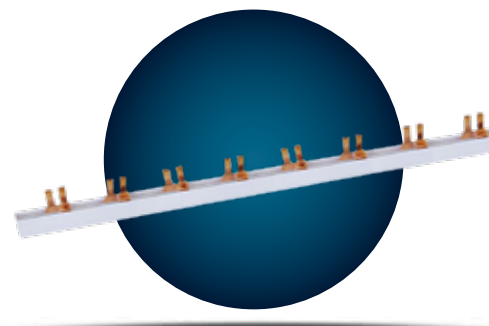

PRODUCTION MATERIAL: **PVC & COPPER**  
ΥΛΙΚΟ ΚΑΤΑΣΚΕΥΗΣ: **PVC & ΧΑΛΚΟΣ**

• L TYPE (1P) L+N • ΤΥΠΟΣ L (1P) L+N



BARCODE	CODE	DESCRIPTION	mm	mm	mm	PACKING	PRICE (€)
5207227076954	500-08000	1P 12θ ΜΕ ΜΟΝΩΣΗ 1P 12 SEATS WITH INSULATION	14,43	14,55	215	1/200	3.85
5207227076961	500-08001	1P 1m ΜΕ ΜΟΝΩΣΗ 1P 1m WITH INSULATION	14,43	14,55	1000	1/50	14.85

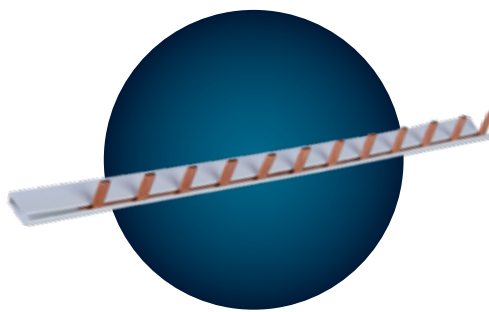

• L TYPE 1P • ΤΥΠΟΣ L 1P



BARCODE	CODE	DESCRIPTION	mm	mm	mm	PACKING	PRICE (€)
5207227076978	500-08002	1P 12θ ΜΕ ΜΟΝΩΣΗ 1P 12 SEATS WITH INSULATION	14,43	14,55	215	1/500	2.05
5207227076985	500-08003	1P 1m ΜΕ ΜΟΝΩΣΗ 1P 1m WITH INSULATION	14,43	14,55	1000	1/100	7.55

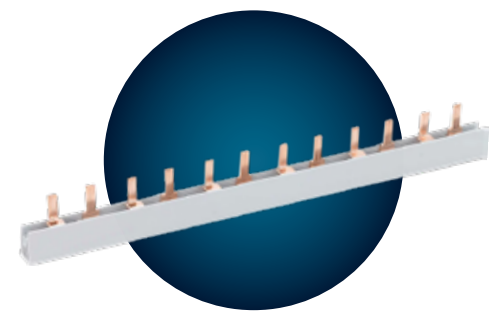

• L TYPE 2P • ΤΥΠΟΣ L 2P



BARCODE	CODE	DESCRIPTION	mm	mm	mm	PACKING	PRICE (€)
5207227076992	500-08004	2P 12θ ΜΕ ΜΟΝΩΣΗ 2P 12 SEATS WITH INSULATION	25	10	215	1/200	3.45
5207227077005	500-08005	2P 1m ΜΕ ΜΟΝΩΣΗ 2P 1m WITH INSULATION	25	10	1000	1/50	13.85

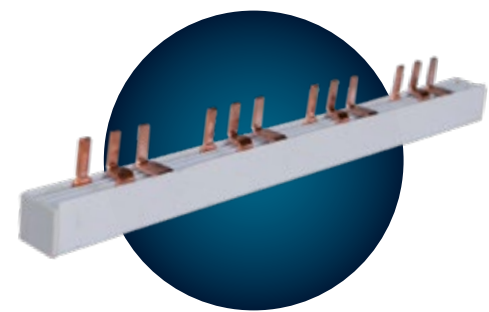

• L TYPE 3P • ΤΥΠΟΣ L 3P



BARCODE	CODE	DESCRIPTION	mm	mm	mm	PACKING	PRICE (€)
5207227077012	500-08006	3P 12θ ΜΕ ΜΟΝΩΣΗ 3P 12 SEATS WITH INSULATION	25,09	15,23	215	1/150	4.55
5207227077029	500-08007	3P 1m ΜΕ ΜΟΝΩΣΗ 3P 1m WITH INSULATION	25,09	15,23	1000	1/50	18.75

• COPPER BUSBARS • ΓΕΦΥΡΕΣ ΧΑΛΚΟΥ

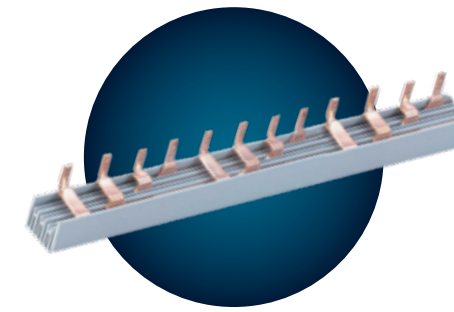

PRODUCTION MATERIAL: **PVC & COPPER**  
ΥΛΙΚΟ ΚΑΤΑΣΚΕΥΗΣ: **PVC & ΧΑΛΚΟΣ**

• L TYPE 4P • ΤΥΠΟΣ L 4P



BARCODE	CODE	DESCRIPTION	mm	mm	mm	PACKING	PRICE (€)
5207227077036	500-08008	4P 12θ ΜΕ ΜΟΝΩΣΗ 4P 12 SEATS WITH INSULATION	25,09	15,23	215	1/120	6.60
5207227077043	500-08009	4P 1m ΜΕ ΜΟΝΩΣΗ 4P 1m WITH INSULATION	25,09	15,23	1000	1/30	27.60

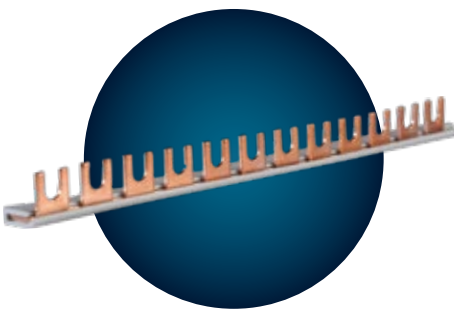

• U TYPE 1P • ΤΥΠΟΣ U 1P



BARCODE	CODE	DESCRIPTION	mm	mm	mm	PACKING	PRICE (€)
5207227077050	500-08010	1P 12θ ΜΕ ΜΟΝΩΣΗ 1P 12 SEATS WITH INSULATION	14,43	14,55	215	1/500	2.05
5207227077067	500-08011	1P 1m ΜΕ ΜΟΝΩΣΗ 1P 1m WITH INSULATION	14,43	14,55	1000	1/100	8.45

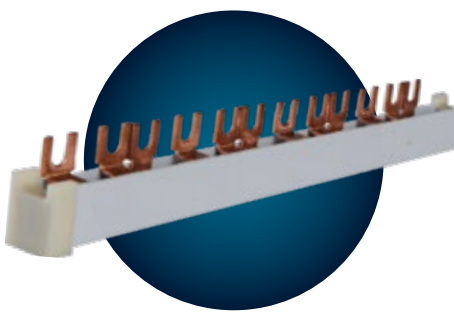

• U TYPE 3P • ΤΥΠΟΣ U 3P



BARCODE	CODE	DESCRIPTION	mm	mm	mm	PACKING	PRICE (€)
5207227077074	500-08012	3P 12θ ΜΕ ΜΟΝΩΣΗ 3P 12 SEATS WITH INSULATION	25,09	15,23	215	1/150	4.85
5207227077081	500-08013	3P 1m ΜΕ ΜΟΝΩΣΗ 3P 1m WITH INSULATION	25,09	15,23	1000	1/50	18.90



## EBS

- VOLTAGE PROTECTORS
- ΕΠΙΤΗΡΗΤΕΣ ΤΑΣΗΣ

**GACIA**  
by EUROLAMP

PRODUCTION MATERIAL: **PLASTIC**  
ΥΛΙΚΟ ΚΑΤΑΣΚΕΥΗΣ: **ΠΛΑΣΤΙΚΟ**



BARCODE	CODE	FACTORY CODE	DESCRIPTION	mm	mm	mm	PACKING	PRICE (€)
5207227031502	500-22500	EBS2P	2P 40A 175-275V	65	77	36	1/6/120	11.65
5207227031533	500-22501	EBS2P	2P 63A 175-275V	65	77	36	1/6/120	18.65
5207227031564	500-22502	EBSTP1	4P 63A 300-460V	65	77	72	1/3/60	71.65



## SPD

- SURGE PROTECTIVE DEVICES 1P
- ΑΝΤΙΚΕΡΑΥΝΙΚΟ ΜΟΝΟΛΙΚΟ 1P

**GACIA**  
by EUROLAMP

PRODUCTION MATERIAL: **PLASTIC**  
ΥΛΙΚΟ ΚΑΤΑΣΚΕΥΗΣ: **ΠΛΑΣΤΙΚΟ**



BARCODE	CODE	FACTORY CODE	DESCRIPTION	mm	mm	mm	PACKING	PRICE (€)
5206139035097	500-22200	SPD	1P 20kA	94,6	67	18	1/4/100	14.65



## SPD

- SURGE PROTECTIVE DEVICE 4P
- ΑΝΤΙΚΕΡΑΥΝΙΚΟ ΤΕΤΡΑΠΟΛΙΚΟ 4P

**GACIA**  
by EUROLAMP

PRODUCTION MATERIAL: **PLASTIC**  
ΥΛΙΚΟ ΚΑΤΑΣΚΕΥΗΣ: **ΠΛΑΣΤΙΚΟ**



BARCODE	CODE	FACTORY CODE	DESCRIPTION	mm	mm	mm	PACKING	PRICE (€)
5206139035103	500-22201	SPD	4P 40kA	94,6	67	72	1/25	83.60



- SURGE PROTECTIVE DEVICE SINGLE PHASE T2
- ΑΝΤΙΚΕΡΑΥΝΙΚΟ ΜΟΝΟΦΑΣΙΚΟ T2

**GACIA**  
by EUROLAMP

PRODUCTION MATERIAL: **PBT**  
ΥΛΙΚΟ ΚΑΤΑΣΚΕΥΗΣ: **PBT**



BARCODE	CODE	FACTORY CODE	DESCRIPTION	mm	mm	mm	PACKING	PRICE (€)
5207227076855	500-22202	N8UE2	2P 20kA-40kA	90	62	36	1/112	24.60



- SURGE PROTECTIVE DEVICE SINGLE PHASE T1-T2
- ΑΝΤΙΚΕΡΑΥΝΙΚΟ ΜΟΝΟΦΑΣΙΚΟ T1-T2

**GACIA**  
by EUROLAMP

PRODUCTION MATERIAL: **PBT**  
ΥΛΙΚΟ ΚΑΤΑΣΚΕΥΗΣ: **PBT**



BARCODE	CODE	FACTORY CODE	DESCRIPTION	mm	mm	mm	PACKING	PRICE (€)
5207227076862	500-22203	N8UE1+2	1P+NPE 12.5kA	90	62	36	1/112	53.30



- SURGE PROTECTIVE DEVICE TRIPLE PHASE T2
- ΑΝΤΙΚΕΡΑΥΝΙΚΟ ΤΡΙΦΑΣΙΚΟ T2

**GACIA**  
by EUROLAMP

PRODUCTION MATERIAL: **PBT**  
ΥΛΙΚΟ ΚΑΤΑΣΚΕΥΗΣ: **PBT**



BARCODE	CODE	FACTORY CODE	DESCRIPTION	mm	mm	mm	PACKING	PRICE (€)
5207227076879	500-22204	N8UE2	4P 20kA-40kA	90	62	72	1/56	48.95



- SURGE PROTECTIVE DEVICE TRIPLE PHASE T1-T2
- ΑΝΤΙΚΕΡΑΥΝΙΚΟ ΤΡΙΦΑΣΙΚΟ T1-T2

**GACIA**  
by EUROLAMP

PRODUCTION MATERIAL: **PBT**  
ΥΛΙΚΟ ΚΑΤΑΣΚΕΥΗΣ: **PBT**



BARCODE	CODE	FACTORY CODE	DESCRIPTION	mm	mm	mm	PACKING	PRICE (€)
5207227076886	500-22205	N8UE1+2	4P 20kA-40kA	90	62	72	1/56	65.60

- ELECTRIC POWER SWITCHES ISOLATOR 3P
- ΔΙΑΚΟΠΤΕΣ ΡΕΥΜΑΤΟΣ ISOLATOR 3P



**GACIA**  
EUROLAMP

PRODUCTION MATERIAL: **PC & PA**  
ΥΛΙΚΟ ΚΑΤΑΣΚΕΥΗΣ: **ΠΟΛΥΚΑΡΒΟΝΙΚΟ & ΠΟΛΥΑΜΙΔΙΟ**



BARCODE	CODE	FACTORY CODE	DESCRIPTION	↑ mm	↗ mm	↔ mm	PACKING	PRICE (€)
5207227076893	500-12101	GKF 3P 20A	3X20A 3P	89	82	175	1/20	16.85
5207227076909	500-12103	GKF 3P 35A	3X35A 3P	89	82	175	1/20	16.85
5207227076916	500-12105	GKF 3P 63A	3X63A 3P	89	82	175	1/20	16.85

- ELECTRIC POWER SWITCHES ISOLATOR 4P
- ΔΙΑΚΟΠΤΕΣ ΡΕΥΜΑΤΟΣ ISOLATOR 4P



**GACIA**  
EUROLAMP

PRODUCTION MATERIAL: **PC & PA**  
ΥΛΙΚΟ ΚΑΤΑΣΚΕΥΗΣ: **ΠΟΛΥΚΑΡΒΟΝΙΚΟ & ΠΟΛΥΑΜΙΔΙΟ**



BARCODE	CODE	FACTORY CODE	DESCRIPTION	↑ mm	↗ mm	↔ mm	PACKING	PRICE (€)
5207227076923	500-12111	GKF 4P 20A	4X20A 4P	89	82	175	1/20	18.80
5207227076930	500-12113	GKF 4P 35A	4X35A 4P	89	82	175	1/20	18.80
5207227076947	500-12115	GKF 4P 63A	4X63A 4P	89	82	175	1/20	18.80

## FS32

- FUSE BASES
- ΑΣΦΑΛΕΙΑΠΟΖΕΥΚΤΕΣ



**GACIA**  
EUROLAMP

PRODUCTION MATERIAL: **PLASTIC**  
ΥΛΙΚΟ ΚΑΤΑΣΚΕΥΗΣ: **ΠΛΑΣΤΙΚΟ**



BARCODE	CODE	FACTORY CODE	DESCRIPTION	↑ mm	↗ mm	↔ mm	PACKING	PRICE (€)
5206139280015	500-22000	FS32	1P 10x38 6-32A	80	78,5	17,5	1/12/120	1.95
5206139280022	500-22001	FS32	3P 10x38 6-32A	80	78,5	52,5	1/4/40	5.85

## SK

- DIN RAIL SOCKET
- ΠΡΙΖΑ ΣΟΥΚΟ ΡΑΓΑΣ



**GACIA**  
EUROLAMP

PRODUCTION MATERIAL: **PLASTIC**  
ΥΛΙΚΟ ΚΑΤΑΣΚΕΥΗΣ: **ΠΛΑΣΤΙΚΟ**



BARCODE	CODE	FACTORY CODE	DESCRIPTION	↑ mm	↗ mm	↔ mm	PACKING	PRICE (€)
5206139280008	500-16000	SK	3P 16A	80	67,5	44,0	1/5/50	3.45

## SR

- MECHANICAL TIMER
- ΧΡΟΝΟΔΙΑΚΟΠΤΗΣ ΡΑΓΑΣ



**GACIA**  
EUROLAMP

ΜΕ ΕΦΕΔΡΕΙΑ 70 ΩΡΕΣ  
DISCHARGE TIME 70 HOURS

PRODUCTION MATERIAL: **PLASTIC**  
ΥΛΙΚΟ ΚΑΤΑΣΚΕΥΗΣ: **ΠΛΑΣΤΙΚΟ**



BARCODE	CODE	FACTORY CODE	DESCRIPTION	↑ mm	↗ mm	↔ mm	PACKING	PRICE (€)
5206139280039	500-35000	SR-3	1P 16A	90	60	17,5	1/100	17.65



## SPD

- SURGE PROTECTIVE DEVICES T2
- ΑΝΤΙΚΕΡΑΥΝΙΚΑ T2

**GACIA**  
by EUROLAMP

PRODUCTION MATERIAL: **PLASTIC**  
ΥΛΙΚΟ ΚΑΤΑΣΚΕΥΗΣ: **ΠΛΑΣΤΙΚΟ**



BARCODE	CODE	FACTORY CODE	DESCRIPTION	mm	mm	mm	PACKING	PRICE (€)
5207227046551	500-22216	EBS2U	T2 20kA-40kA 275V 2P	90	70	36	1/54	24.60
5207227030314	500-22211	EBS2U	T2 20kA-40kA 385V 4P	90	70	72	1/36	52.10



- SURGE PROTECTIVE DEVICES T1-T2
- ΑΝΤΙΚΕΡΑΥΝΙΚΑ T1-T2

**GACIA**  
by EUROLAMP

PRODUCTION MATERIAL: **PLASTIC**  
ΥΛΙΚΟ ΚΑΤΑΣΚΕΥΗΣ: **ΠΛΑΣΤΙΚΟ**



BARCODE	CODE	FACTORY CODE	DESCRIPTION	mm	mm	mm	PACKING	PRICE (€)
5207227046568	500-22217	EBS4U	T1-T2 12.5kA 275V 1P+NPE	90	70	18	1/66	62.85
5207227030338	500-22213	EBS3U	T1-T2 20kA-40kA 385V 4P	90	70	72	1/36	69.80



- SURGE PROTECTIVE DEVICE T1-T2-T3
- ΑΝΤΙΚΕΡΑΥΝΙΚΟ T1-T2-T3

**GACIA**  
by EUROLAMP

PRODUCTION MATERIAL: **PLASTIC**  
ΥΛΙΚΟ ΚΑΤΑΣΚΕΥΗΣ: **ΠΛΑΣΤΙΚΟ**



BARCODE	CODE	FACTORY CODE	DESCRIPTION	mm	mm	mm	PACKING	PRICE (€)
5207227030352	500-22215	EBS4U	T1-T2-T3 12.5kA 4P	90	70	72	1/36	119.60



## BX9G

- GENERAL SWITCH CONVERTERS
- ΡΑΓΟΔΙΑΚΟΠΤΕΣ ΜΕΤΑΓΩΓΙΚΟΙ

**GACIA**  
by EUROLAMP

PRODUCTION MATERIAL: **PLASTIC**  
ΥΛΙΚΟ ΚΑΤΑΣΚΕΥΗΣ: **ΠΛΑΣΤΙΚΟ**



BARCODE	CODE	FACTORY CODE	DESCRIPTION	mm	mm	mm	PACKING	PRICE (€)
5207227030284	500-42160	BX9G	2X40A 1-0-2 2P	82	62	36	1/6/90	8.40
5207227030291	500-42161	BX9G	4X40A 1-0-2 4P	82	62	72	1/3/45	16.80



## DZ47

- CIRCUIT BREAKERS (LONG HANDLE)
- ΡΑΓΟΔΙΑΚΟΠΤΕΣ ΔΕΗ

**GACIA**  
by EUROLAMP

PRODUCTION MATERIAL: **PLASTIC**  
ΥΛΙΚΟ ΚΑΤΑΣΚΕΥΗΣ: **ΠΛΑΣΤΙΚΟ**



BARCODE	CODE	FACTORY CODE	DESCRIPTION	mm	mm	mm	PACKING	PRICE (€)
5206139018694	500-42150	DZ47	C 1P 40A 230-400V	83	67	18	1/12/120	2.80
5206139018717	500-42151	DZ47	C 1P 63A 230-400V	83	67	18	1/12/120	2.80
5206139018724	500-42152	DZ47	C 3P 40A 400V	83	67	54	1/4/40	8.36
5206139018731	500-42153	DZ47	C 3P 63A 400V	83	67	54	1/4/40	8.36



- SWITCH SAFETY 2P 3KA WITH TIME SWITCH
- ΑΥΤΟΜΑΤΑΚΙ ΔΙΠΟΛΙΚΟ 2P 3KA ΜΕ ΧΡΟΝΟΔΙΑΚΟΠΤΗ

**GACIA**  
by EUROLAMP

PRODUCTION MATERIAL: **PLASTIC**  
ΥΛΙΚΟ ΚΑΤΑΣΚΕΥΗΣ: **ΠΛΑΣΤΙΚΟ**



BARCODE	CODE	FACTORY CODE	DESCRIPTION	mm	mm	mm	PACKING	PRICE (€)
5207227031960	500-42351	QJDS-63	2x25A 3KA 2P	79	80	85	1/60	19.60

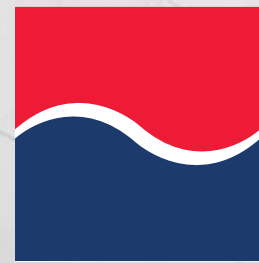

**Marlanvil**  
*Living with More*



## Watertight Enclosures Consumer Units

for Domestic & Professional use

## Κουτιά Εξωτερικά Στεγανά Ηλεκτρικοί Πίνακες

για Οικιακή & Επαγγελματική χρήση

Exclusive representative of selected products from the Italian manufacturer Marlanvil.  
Αποκλειστικός αντιπρόσωπος επιλεγμένων προϊόντων του ιταλικού κατασκευαστικού οίκου Marlanvil.



**Marlanvil**  
*Living with More*



## Κουτιά Εξωτερικά Στεγανά

για Οικιακή & Επαγγελματική χρήση

- Θερμοανθεκτικά τεchnοπολυμερή.
- Υψηλή αντοχή στις χημικές ουσίες και τα υγρά.
- Προστασία από ηλεκτροπληξία.
- Βαθμός στεγανότητας IP.
- Αυτοδιάτρητες Βίδες.
- Ελαστικό παρέμβυσμα EPDM.
- Αυτοκόλλητα μανίκια καλωδίων από PVC, εύκολο άνοιγμα, κατάλληλα για σωλήνες διαφορετικού μεγέθους.
- Μονό πακέτο με θερμοδιαβατική μεμβράνη, πολλαπλή συσκευασία σε κουτί από χαρτόνι.
- Ειδικές εκδόσεις βιομηχανικής χρήσης (με εξατομικευμένες οπές και χρώματα) διατίθενται κατόπιν αιτήματος.

## Watertight Enclosures

for Domestic & Professional use

- Thermoresistant tecnopolymers.
- High resistance to chemicals and weathers.
- Electric shock protected.
- IP Protection.
- Self-tapping screws.
- EPDM rubber gasket.
- Self-extinguishing PVC cable sleeves, easy opening, suitable for different size pipes.
- Single pack with thermoretractable film, multiple pack in cardboard box.
- Industrial use special versions (with personalized holes and colours) are available upon request.

- JUNCTION BOX / IP44
- ΚΟΥΤΙΑ ΕΙΣΩΤΕΡΙΚΑ ΣΤΕΓΑΝΑ / IP44



BARCODE	CODE	FACTORY CODE	COLOR	∅ mm	mm	PACKING	PRICE (€)
8017521110011	151-31500	001	GREY	65	40	1\150	1.28
8017521110035	151-31501	002	GREY	80	40	1\99	1.42

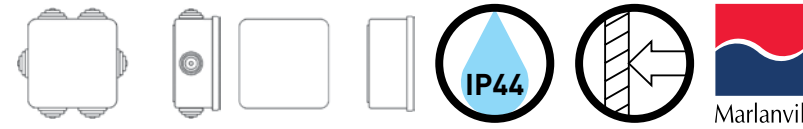

BARCODE	CODE	FACTORY CODE	COLOR	←→ mm	↑ mm	↘ mm	PACKING	PRICE (€)
8017521110042	151-31502	003	GREY	80	80	40	1\60	1.55
8017521110509	151-31503	003.PL	GREY	80	80	40	1\105	1.28



Cover detail  
Λεπτομέρεια καλύμματος

- JUNCTION BOX / IP65
- ΚΟΥΤΙΑ ΕΙΣΩΤΕΡΙΚΑ ΣΤΕΓΑΝΑ / IP65



BARCODE	CODE	FACTORY CODE	COLOR	∅ mm	mm	PACKING	PRICE (€)
8017521110929	151-31510	001.CS	GREY	65	40	1\130	1.64
8017521110936	151-31511	002.CS	GREY	80	40	1\90	2.06
8017521115047	151-31514	002.CS.N	BLACK	80	40	1\90	2.42

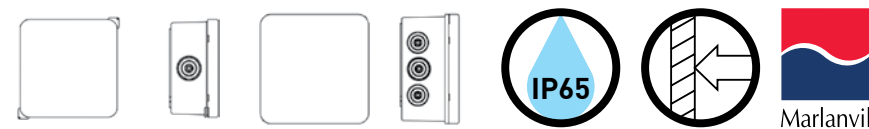

BARCODE	CODE	FACTORY CODE	COLOR	←→ mm	↑ mm	↘ mm	PACKING	PRICE (€)
8017521110943	151-31512	003.CS	GREY	80	80	40	1\90	1.98
8017521110967	151-31513	005.CS	GREY	100	100	50	1\56	3.16
8017521115054	151-31515	003.CS.N	BLACK	85	85	45	1\90	2.33
8017521112305	151-31516	005.PL.N	BLACK	100	100	50	1\100	2.64

- JUNCTION BOX / WITH METALLIC SCREW / IP65
- ΚΟΥΤΙΑ ΕΙΣΩΤΕΡΙΚΑ ΣΤΕΓΑΝΑ / ΜΕ ΜΕΤΑΛΛΙΚΗ ΒΙΔΑ / IP65

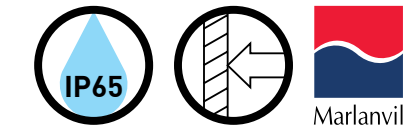
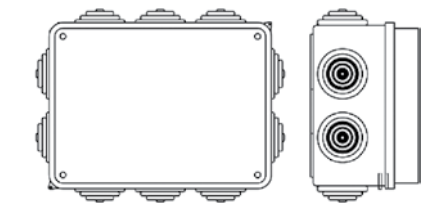

BARCODE	CODE	FACTORY CODE	COLOR	←→ mm	↑ mm	↘ mm	PACKING	PRICE (€)
8017521110073	151-31520	005	GREY	100	100	50	1\60	2.78
8017521110134	151-31521	007	GREY	112	75	51	1\100	3.53
8017521110165	151-31522	008	GREY	150	110	70	1\44	4.85
8017521110240	151-31523	009	GREY	190	145	72	1\25	8.82
8017521110325	151-31524	010	GREY	240	190	90	1\14	14.65
8017521111490	151-31525	011	GREY	243	190	10	1\12	15.75
8017521110998	151-31526	012.A	GREY	300	220	120	1\12	24.25
8017521111001	151-31527	014.A	GREY	376	300	120	1\5	35.35

- JUNCTION BOX / WITH HINGE SCREW / IP66
- ΚΟΥΤΙΑ ΕΙΣΩΤΕΡΙΚΑ ΣΤΕΓΑΝΑ / ΜΕ ΒΙΔΑ ΜΕΝΤΕΣΕ / IP66

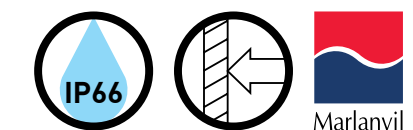

BARCODE	CODE	FACTORY CODE	COLOR	←→ mm	↑ mm	↘ mm	PACKING	PRICE (€)
8017521110097	151-31530	005.PL	GREY	100	100	50	1\100	2.35
8017521110158	151-31531	007.PL	GREY	125	75	50	1\130	2.45
8017521110233	151-31532	008.PL	GREY	150	110	70	1\50	3.85
8017521110318	151-31533	009.PL	GREY	190	145	70	1\28	5.75
8017521110387	151-31534	010.PL	GREY	240	190	90	1\14	11.25
8017521110431	151-31535	011.PL	GREY	240	190	110	1\12	12.60

- JUNCTION BOX / WITH METALLIC SCREW (SHALLOW) / IP66
- ΚΟΥΤΙΑ ΕΞΩΤΕΡΙΚΑ ΣΤΕΓΑΝΑ / ΜΕ ΜΕΤΑΛΛΙΚΗ ΒΙΔΑ (ΡΗΧΟ) / IP66



BARCODE	CODE	FACTORY CODE	COLOR	←→ mm	↑ mm	↗ mm	PACKING	PRICE (€)
8017521111339	151-31540	009.A.PL	GREY	190	140	75	1\30	7.38
8017521111346	151-31541	010.A.PL	GREY	238	190	90	1\14	11.95
8017521111353	151-31542	012.A.PL	GREY	300	220	120	1\7	21.30
8017521111360	151-31543	014.A.PL	GREY	376	300	120	1\6	30.45
8017521111377	151-31544	015.A.PL	GREY	460	380	120	1\4	47.35

- JUNCTION BOX / WITH METALLIC SCREW (DEEP) / IP66
- ΚΟΥΤΙΑ ΕΞΩΤΕΡΙΚΑ ΣΤΕΓΑΝΑ / ΜΕ ΜΕΤΑΛΛΙΚΗ ΒΙΔΑ (ΒΑΘΥ) / IP66

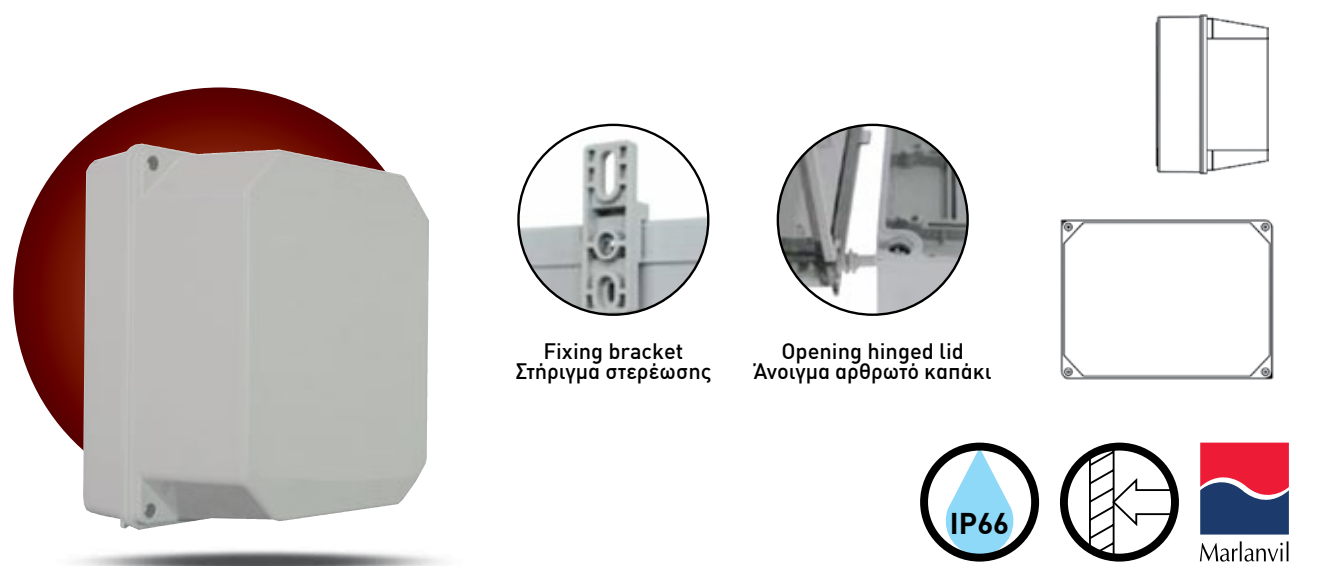

BARCODE	CODE	FACTORY CODE	COLOR	←→ mm	↑ mm	↗ mm	PACKING	PRICE (€)
8017521110172	151-31550	008.CA.G	GREY	150	110	135	1\28	6.55
8017521110257	151-31551	009.CA.G	GREY	190	145	135	1\8	9.65
8017521110332	151-31552	010.CA.G	GREY	243	190	155	1\8	15.55
8017521111452	151-31553	012.CA.G	GREY	310	230	160	1\8	26.15

- JUNCTION BOX FLUSH MOUNTING
- ΚΟΥΤΙΑ ΧΩΝΕΥΤΑ

PRODUCTION MATERIAL: **YELLOW POLYSTYRENE BOX - WHITE COVER RAL 9010**  
 ΥΛΙΚΟ ΚΑΤΑΣΚΕΥΗΣ: **ΚΟΥΤΙ ΑΠΟ ΚΙΤΡΙΝΟ ΠΟΛΥΣΤΥΡΕΝΙΟ - ΛΕΥΚΟ ΚΑΠΑΚΙ RAL 9010**



BARCODE	CODE	FACTORY CODE	COLOR	←→ mm	↑ mm	↗ mm	PACKING	PRICE (€)
8017521160122	151-31590	1611	YELLOW WITH WHITE COVER	92	92	45	1\160	1.42
8017521160153	151-31591	1612	YELLOW WITH WHITE COVER	118	96	50	1\105	1.68
8017521160160	151-31592	1613	YELLOW WITH WHITE COVER	118	96	70	1\80	1.83
8017521160177	151-31593	1614	YELLOW WITH WHITE COVER	157	98	70	1\60	2.23
8017521160184	151-31594	1615	YELLOW WITH WHITE COVER	160	130	70	1\40	2.87
8017521160191	151-31595	1616	YELLOW WITH WHITE COVER	196	152	70	1\26	4.16
8017521160207	151-31596	1617	YELLOW WITH WHITE COVER	297	152	70	1\17	5.55
8017521160214	151-31597	1618	YELLOW WITH WHITE COVER	392	152	70	1\20	7.69
8017521160221	151-31598	1619	YELLOW WITH WHITE COVER	480	160	70	1\16	9.50

- METALLIC MOUNTING PLATES / WITH FIXING SCREWS
- ΜΕΤΑΛΛΙΚΕΣ ΠΛΑΚΕΣ ΣΤΗΡΙΞΗΣ / ΜΕ ΒΙΔΕΣ ΣΤΕΡΕΩΣΗΣ

PRODUCTION MATERIAL: **ZINC-COATED**  
 ΥΛΙΚΟ ΚΑΤΑΣΚΕΥΗΣ: **ΕΠΙΧΡΙΣΜΑ ΜΕ ΨΕΥΔΑΡΓΥΡΟ**



BARCODE	CODE	FACTORY CODE	COLOR	←→ mm	↑ mm	↗ mm	PACKING	PRICE (€)
8017521143668	151-31950	1009.PF	SILVER	180	118	1,5	1\10	5.85
8017521143675	151-31951	1010.PF	SILVER	212	162	1,5	1\30	7.45
8017521143682	151-31952	1012.PF	SILVER	270	190	1,5	1\20	8.65
8017521143699	151-31953	1014.PF	SILVER	358	283	2	1\10	16.55

## THE PERFECT SOLUTION

FOR ANY DOMESTIC  
AND PROFESSIONAL USE

## Η ΤΕΛΕΙΑ ΛΥΣΗ

ΓΙΑ ΚΑΘΕ ΟΙΚΙΑΚΗ  
ΚΑΙ ΕΠΑΓΓΕΛΜΑΤΙΚΗ ΧΡΗΣΗ

- ▶ **Wide range of products suitable for any application**  
Μεγάλη γκάμα προϊόντων κατάλληλα για κάθε εφαρμογή
- ▶ **Many installation capabilities**  
Πολλές δυνατότητες εγκατάστασης
- ▶ **Easy to install**  
Εύκολοι στην εγκατάσταση
- ▶ **Security and reliability**  
Ασφάλεια και αξιοπιστία
- ▶ **Spacious and ergonomic**  
Ευρύχωροι και εργονομικοί
- ▶ **Reliable technology**  
Αξιόπιστη τεχνολογία



**Marlanvil**  
*Living with More*

- FUSE BOXES PLASTIC FLUSH MOUNTING / IP40
- ΠΙΝΑΚΕΣ ΧΩΝΕΥΤΟΙ ΠΛΑΣΤΙΚΟΙ / IP40

COLOR: **WHITE** ΧΡΩΜΑ: **ΛΕΥΚΟ**

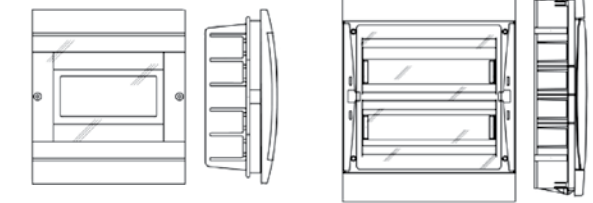
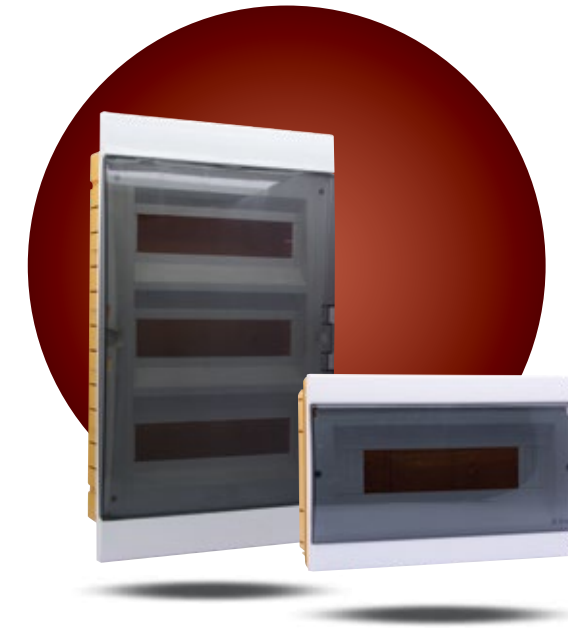

151-31003

151-31004 & 151-31005

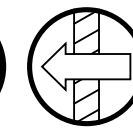

BARCODE	CODE	FACTORY CODE	DESCRIPTION	←→ mm	↑ mm	↗	PACKING	PRICE (€)
8017521071008	151-31003	970.12.B	1 ΣΕΙΡΑΣ 14 ΘΕΣΕΩΝ / 14Μ	300	200	95	1\10	15.30
8017521071077	151-31004	970.24.B	2 ΣΕΙΡΩΝ 26 ΘΕΣΕΩΝ / 26Μ	315	405	110	1	33.85
8017521071121	151-31005	970.36.B	3 ΣΕΙΡΩΝ 39 ΘΕΣΕΩΝ / 39Μ	315	525	110	1	42.60

- FUSE BOXES PLASTERBOARD FLUSH MOUNTING / IP40
- ΠΙΝΑΚΕΣ ΧΩΝΕΥΤΟΙ ΓΥΦΟΣΑΝΙΔΑΣ / IP40

COLOR: **WHITE** ΧΡΩΜΑ: **ΛΕΥΚΟ**

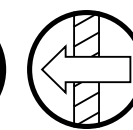
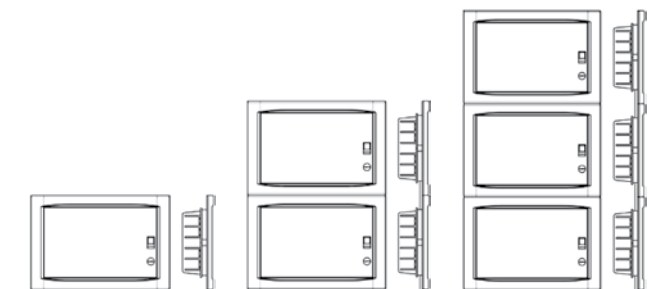

BARCODE	CODE	FACTORY CODE	DESCRIPTION	←→ mm	↑ mm	↗	PACKING	PRICE (€)
8017521270043	151-31010	990.12.CG	1 ΣΕΙΡΑΣ 12 ΘΕΣΕΩΝ / 12Μ	369	250	102	1	31.25
8017521270159	151-31011	990.24.CG	2 ΣΕΙΡΩΝ 24 ΘΕΣΕΩΝ / 24Μ	369	500	102	1	63.85
8017521270388	151-31012	990.36.CG	3 ΣΕΙΡΩΝ 36 ΘΕΣΕΩΝ / 36Μ	369	750	102	1	96.55



- FUSE BOXES / WITH DOOR / IP40
- ΠΙΝΑΚΕΣ ΕΞΩΤΕΡΙΚΟΙ / ΜΕ ΠΟΡΤΑ / IP40

COLOR: **GREY** ΧΡΩΜΑ: **ΓΚΡΙ**

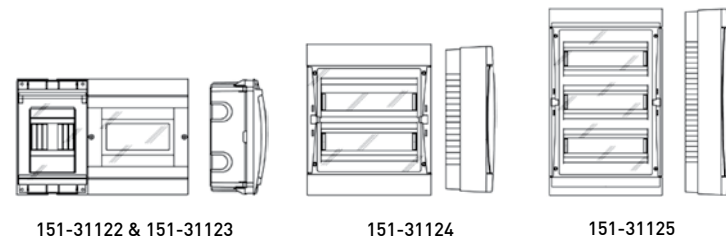
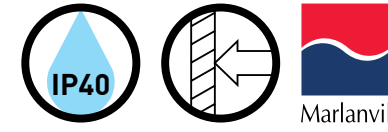

BARCODE	CODE	FACTORY CODE	DESCRIPTION	←→ mm	↑ mm	↗ mm	PACKING	PRICE (€)
8017521071251	151-31122	9700.08	8 ΘΕΣΕΩΝ / 8Μ	230	200	110	1\14	12.60
8017521071299	151-31123	9700.12	12 ΘΕΣΕΩΝ / 12Μ	300	200	110	1\10	16.25
8017521071343	151-31124	9700.24	24 ΘΕΣΕΩΝ / 24Μ	315	400	110	1	39.25
8017521071374	151-31125	9700.36	36 ΘΕΣΕΩΝ / 36Μ	315	525	110	1	53.25

- EARTH-NEUTRAL CONNECTOR
- ΜΠΑΡΕΣ ΟΥΔΕΤΕΡΟΥ & ΓΕΙΩΣΗΣ

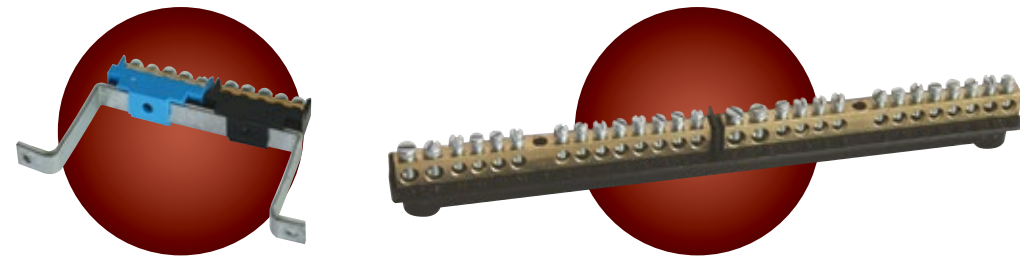

BARCODE	CODE	FACTORY CODE	DESCRIPTION	PACKING	PRICE (€)
8017521140650	151-31900	1006.04	4 ΘΕΣΕΩΝ / 4Μ	1\20	3.90
8017521141763	151-31901	1006.06	6 ΘΕΣΕΩΝ / 6Μ	1\30	4.85
8017521140674	151-31902	1006.08	8 ΘΕΣΕΩΝ / 8Μ	1\20	5.80
8017521140698	151-31903	1006.12	12 ΘΕΣΕΩΝ / 12Μ	1\20	6.95
8017521143361	151-31904	1006.18	18 ΘΕΣΕΩΝ / 18Μ	1\50	9.11
8017521140711	151-31905	1006.24	24 ΘΕΣΕΩΝ / 24Μ	1\10	11.52
8017521140735	151-31906	1006.36	36 ΘΕΣΕΩΝ / 36Μ	1\8	17.18
8017521140575	151-31907	1006.48	48 ΘΕΣΕΩΝ / 48Μ	1\5	19.54
8017521090955	151-31908	1006.940.36	36 ΘΕΣΕΩΝ / 36Μ FOR 151-31155	1\16	29.20
8017521090962	151-31909	1006.940.54	54 ΘΕΣΕΩΝ / 54Μ FOR 151-31156	1\12	43.41
8017521090979	151-31910	1006.940.72	72 ΘΕΣΕΩΝ / 72Μ FOR 151-31157	1\10	57.61

- FUSE BOXES / WITHOUT DOOR / IP40
- ΠΙΝΑΚΕΣ ΕΞΩΤΕΡΙΚΟΙ / ΧΩΡΙΣ ΠΟΡΤΑ / IP40

COLOR: **GREY** ΧΡΩΜΑ: **ΓΚΡΙ**

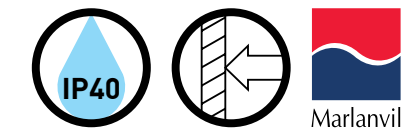
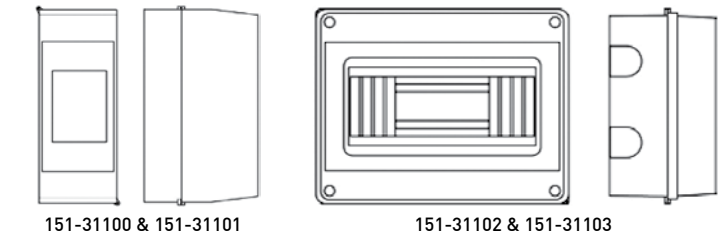

BARCODE	CODE	FACTORY CODE	DESCRIPTION	←→ mm	↑ mm	↗ mm	PACKING	PRICE (€)
8017521090016	151-31100	90.02	2 ΘΕΣΕΩΝ / 2Μ	55	135	80	1\50	2.30
8017521090092	151-31101	90.04	4 ΘΕΣΕΩΝ / 4Μ	100	135	90	1\60	3.15
8017521094472	151-31102	90.06	6 ΘΕΣΕΩΝ / 6Μ	140	135	90	1\44	3.60
8017521090177	151-31103	90.08	8 ΘΕΣΕΩΝ / 8Μ	200	160	90	1\26	6.50

- FUSE BOXES / WITH DOOR / IP65
- ΠΙΝΑΚΕΣ ΕΞΩΤΕΡΙΚΟΙ / ΜΕ ΠΟΡΤΑ

• **IP65**

COLOR: **GREY** ΧΡΩΜΑ: **ΓΚΡΙ**

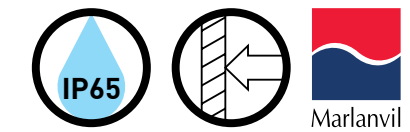
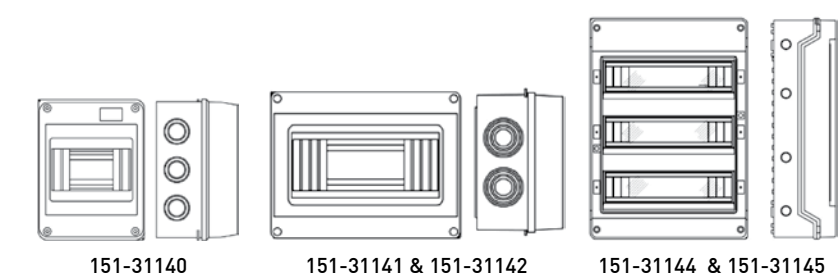

BARCODE	CODE	FACTORY CODE	DESCRIPTION	←→ mm	↑ mm	↗ mm	PACKING	PRICE (€)
8017521090511	151-31140	92.04	4 ΘΕΣΕΩΝ / 4Μ	120	160	90	1\40	8.25
8017521090535	151-31141	92.08	8 ΘΕΣΕΩΝ / 8Μ	200	160	90	1\26	11.75
8017521090559	151-31142	92.12	12 ΘΕΣΕΩΝ / 12Μ	250	200	110	1\14	17.90
8017521090740	151-31144	920.24	24 ΘΕΣΕΩΝ / 24Μ	375	250	140	1	37.80
8017521090764	151-31145	920.48	48 ΘΕΣΕΩΝ / 48Μ	500	355	140	1	93.60

- FUSE BOXES / WITH DOOR
- ΠΙΝΑΚΕΣ ΕΙΩΤΕΡΙΚΟΙ / ΜΕ ΠΟΡΤΑ
- IP65

COLOR: GREY ΧΡΩΜΑ: ΓΚΡΙ

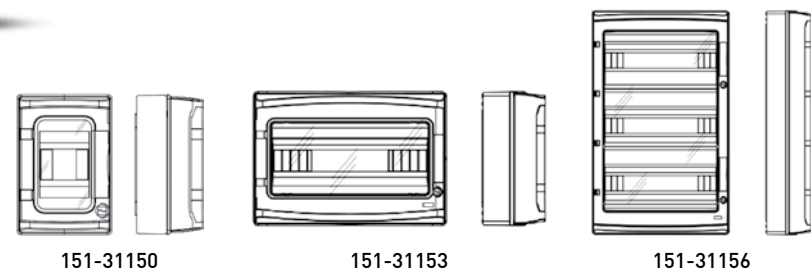
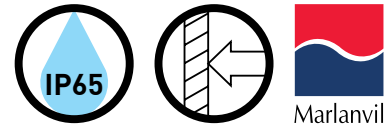

BARCODE	CODE	FACTORY CODE	DESCRIPTION	←→ mm	↑ mm	↗ mm	PACKING	PRICE (€)
8017521094823	151-31150	940.04	4 ΘΕΣΕΩΝ / 4M	142	210	100	1\20	16.95
8017521094830	151-31151	940.08	8 ΘΕΣΕΩΝ / 8M	215	210	100	1\8	23.55
8017521094847	151-31152	940.12	12 ΘΕΣΕΩΝ / 12M	290	260	133	1\4	37.60
8017521094854	151-31153	940.18	18 ΘΕΣΕΩΝ / 18M	410	280	133	1	51.25
8017521094892	151-31154	940.24	24 ΘΕΣΕΩΝ / 24M	290	420	133	1	55.65
8017521094861	151-31155	940.36	36 ΘΕΣΕΩΝ / 36M	432	464	160	1	162.40
8017521094878	151-31156	940.54	54 ΘΕΣΕΩΝ / 54M	432	639	160	1	232.50
8017521094885	151-31157	940.72	72 ΘΕΣΕΩΝ / 72M	432	879	160	1	308.80



- Distribution board with smooth sides for entry with all glands in any point
- Πίνακας ελέγχου με ομαλές πλευρές για είσοδο σε οποιοδήποτε σημείο του τοίχου με οποιοδήποτε τύπο σύνδεσης



- Removable flange to wire easily
- Αφαιρούμενη φλάντζα για εύκολη καλωδίωση



- Security lock with key
- Κλείδωμα ασφαλείας με κλειδί



- Flexible DIN rail fixing
- Ευέλικτη στερέωση στη ράγα



**LINDNER**  
by EUROLAMP®

- Ασφάλειες για Οικιακή & Επαγγελματική χρήση
- Fuses for Domestic & Professional use

Discover our Collection ►

- LINDNER NEOZET FUSES
- ΑΣΦΑΛΕΙΕΣ ΝΕΟΖΕΤ LINDNER

PRODUCTION MATERIAL: **PORCELAIN & METALLIC**  
ΥΛΙΚΟ ΚΑΤΑΣΚΕΥΗΣ: **ΠΟΡΣΕΛΑΝΗ & ΜΕΤΑΛΛΙΚΟ**



BARCODE	CODE	AMPER	∅ mm	↑ mm	PACKING	PRICE (€)
5207227004872	147-61002	6A	11	36	1/10/1000	0.54
5207227006142	147-61003	10A	11	36	1/10/1000	0.54
5207227006159	147-61004	16A	11	36	1/10/1000	0.54
5207227006166	147-61005	20A	16	36	1/10/1000	0.58
5207227006197	147-61006	25A	16	36	1/10/1000	0.58
5207227006210	147-61007	35A	16	36	1/10/1000	0.58
5207227006227	147-61008	50A	16	36	1/10/1000	0.58
5207227006234	147-61009	63A	16	36	1/10/1000	0.58
5207227006241	147-61010	80A	24,5	43	1/10/500	1.92
5207227006258	147-61011	100A	24,5	43	1/10/500	1.98

- LINDNER NORMAL FUSES
- ΑΣΦΑΛΕΙΕΣ NORMAL LINDNER

PRODUCTION MATERIAL: **PORCELAIN & METALLIC**  
ΥΛΙΚΟ ΚΑΤΑΣΚΕΥΗΣ: **ΠΟΡΣΕΛΑΝΗ & ΜΕΤΑΛΛΙΚΟ**



BARCODE	CODE	AMPER	∅ mm	↑ mm	PACKING	PRICE (€)
5207227006265	147-61020	2A	22	50	1/5/500	0.64
5207227006272	147-61021	4A	22	50	1/5/500	0.64
5207227006289	147-61022	6A	22,5	49	1/5/500	0.64
5207227006296	147-61023	10A	22,5	49	1/5/500	0.64
5207227006302	147-61024	16A	22,5	49	1/5/500	0.64
5207227006319	147-61025	20A	22,5	49	1/5/500	0.64
5207227006326	147-61026	25A	22,5	49	1/5/500	0.64
5207227006333	147-61027	35A	27	50	1/5/350	0.81
5207227006340	147-61028	50A	27	50	1/5/350	0.81
5207227006357	147-61029	63A	27	50	1/5/350	0.81
5207227006364	147-61030	80A	37	63	1/10/180	2.12
5207227006371	147-61031	100A	37	63	1/10/180	2.12

- LINDNER DEH FUSES
- ΑΣΦΑΛΕΙΕΣ ΔΕΗ LINDNER

PRODUCTION MATERIAL: **PORCELAIN & METALLIC**  
ΥΛΙΚΟ ΚΑΤΑΣΚΕΥΗΣ: **ΠΟΡΣΕΛΑΝΗ & ΜΕΤΑΛΛΙΚΟ**

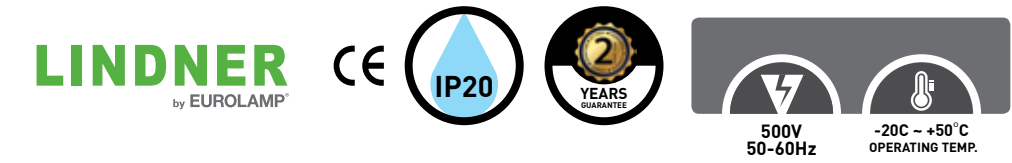

BARCODE	CODE	AMPER	∅ mm	↑ mm	PACKING	PRICE (€)
5207227006456	147-61050	30A	12,5	50	1/10/1000	0.66
5207227006463	147-61051	35A	12,5	50	1/10/1000	0.66
5207227006470	147-61052	40A	12,5	50	1/10/1000	0.71
5207227006487	147-61053	50A	12,5	50	1/10/1000	0.71

- LINDNER BLADE No. 00 FUSES
- ΑΣΦΑΛΕΙΕΣ ΜΑΧΑΙΡΩΤΕΣ No. 00 LINDNER

PRODUCTION MATERIAL: **PORCELAIN & METALLIC**  
ΥΛΙΚΟ ΚΑΤΑΣΚΕΥΗΣ: **ΠΟΡΣΕΛΑΝΗ & ΜΕΤΑΛΛΙΚΟ**

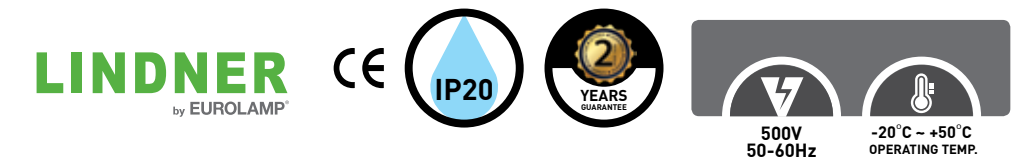

BARCODE	CODE	AMPER	← mm	↑ mm	↗ mm	PACKING	PRICE (€)
5207227006494	147-61304	35A	78	59	29	1/3/90	2.81
5207227006500	147-61305	50A	78	59	29	1/3/90	2.81
5207227006517	147-61306	63A	78	59	29	1/3/90	2.81
5207227006524	147-61307	80A	78	59	29	1/3/90	2.81
5207227006531	147-61308	100A	78	59	29	1/3/90	2.81
5207227006548	147-61309	125A	78	59	29	1/3/90	2.81
5207227006555	147-61310	160A	78	59	29	1/3/90	3.22

- LINDNER CYLINDRICAL FUSES
- ΑΣΦΑΛΕΙΕΣ ΚΥΛΙΝΔΡΙΚΕΣ LINDNER

PRODUCTION MATERIAL: **PORCELAIN & METALLIC**  
ΥΛΙΚΟ ΚΑΤΑΣΚΕΥΗΣ: **ΠΟΡΣΕΛΑΝΗ & ΜΕΤΑΛΛΙΚΟ**

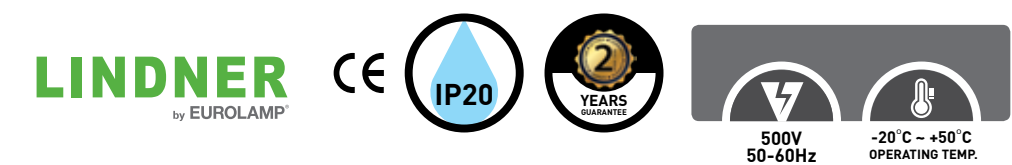

BARCODE	CODE	AMPER	∅ mm	↑ mm	PACKING	PRICE (€)
5206139004710	147-61204	25A	10,3	38	1/10/2000	0.26
5206139004727	147-61205	32A	10,3	38	1/10/2000	0.26

- LINDNER ADAPTER
- ΜΗΤΡΕΣ LINDNER

PRODUCTION MATERIAL: **PORCELAIN & METALLIC**  
ΥΛΙΚΟ ΚΑΤΑΣΚΕΥΗΣ: **ΠΟΡΣΕΛΑΝΗ & ΜΕΤΑΛΛΙΚΟ**



BARCODE	CODE	AMPER	∅ mm	↑ mm	PACKING	PRICE (€)
5207227006388	147-61040	10A	23	17	1/25/500	0.68
5207227006395	147-61041	16A	23	17	1/25/500	0.68
5207227006401	147-61042	20A	23	17	1/25/500	0.92
5207227006418	147-61043	25A	23	17	1/25/500	0.92
5207227006425	147-61044	35A	29	17	1/25/500	1.21
5207227006432	147-61045	50A	29	17	1/25/500	1.36
5207227006449	147-61046	63A	29	17	1/25/500	1.60

- LINDNER NEOZET BASES
- ΒΑΣΕΙΣ NEOZET LINDNER

PRODUCTION MATERIAL: **PORCELAIN & METALLIC**  
ΥΛΙΚΟ ΚΑΤΑΣΚΕΥΗΣ: **ΠΟΡΣΕΛΑΝΗ & ΜΕΤΑΛΛΙΚΟ**

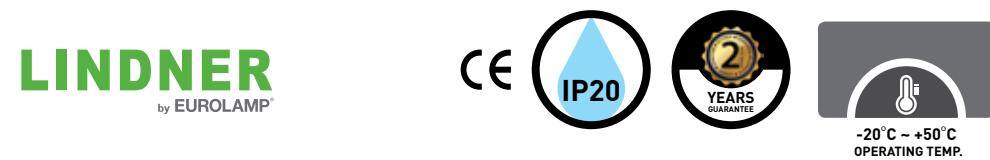

BARCODE	CODE	AMPER	←→ mm	↑ mm	↗ mm	PACKING	PRICE (€)
5207227006562	147-61500	63A	62	47	27	1/20/200	2.39
5207227006579	147-61501	100A	86	60	44	1/5/60	3.65

- LINDNER NEOZET CAPS
- ΠΩΜΑ NEOZET LINDNER

PRODUCTION MATERIAL: **PORCELAIN & METALLIC**  
ΥΛΙΚΟ ΚΑΤΑΣΚΕΥΗΣ: **ΠΟΡΣΕΛΑΝΗ & ΜΕΤΑΛΛΙΚΟ**

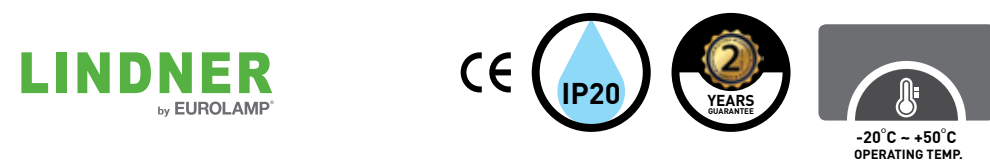

BARCODE	CODE	AMPER	∅ mm	↑ mm	PACKING	PRICE (€)
5207227006616	147-61510	63A	24	32	1/20/500	0.72
5207227006623	147-61511	100A	39,5	40	1/10/240	2.32

- LINDNER NEOZET COVERS
- ΚΑΛΥΜΜΑΤΑ NEOZET LINDNER

PRODUCTION MATERIAL: **PLASTIC**  
ΥΛΙΚΟ ΚΑΤΑΣΚΕΥΗΣ: **ΠΛΑΣΤΙΚΟ**

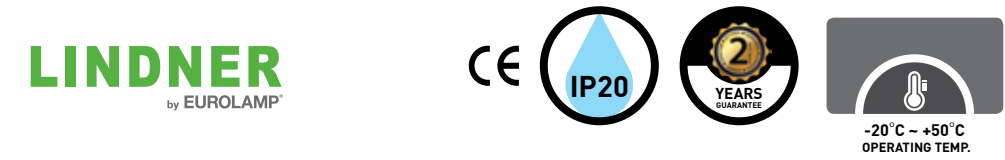

BARCODE	CODE	AMPER	←→ mm	↑ mm	↗ mm	PACKING	PRICE (€)
5207227006678	147-61520	63A	72	22	27	1/40/500	0.53
5207227006685	147-61521	100A	84,5	17	44	1/30/300	0.63

- LINDNER BASES NORMAL
- ΒΑΣΕΙΣ NORMAL LINDNER

PRODUCTION MATERIAL: **PORCELAIN & METALLIC**  
ΥΛΙΚΟ ΚΑΤΑΣΚΕΥΗΣ: **ΠΟΡΣΕΛΑΝΗ & ΜΕΤΑΛΛΙΚΟ**

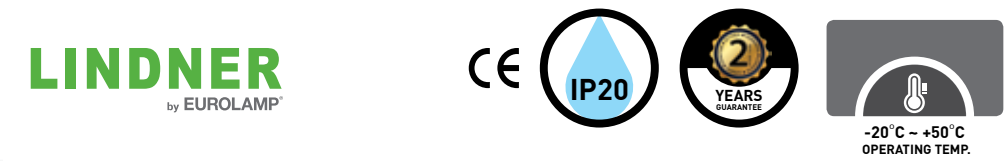

BARCODE	CODE	AMPER	←→ mm	↑ mm	↗ mm	PACKING	PRICE (€)
5207227006586	147-61502	25A	80,5	60,5	39	1/6/120	2.13
5207227006593	147-61503	63A	79	55,5	48	1/10/90	2.84
5207227006609	147-61504	100A	96,5	91	79,5	1/20	12.60

- LINDNER CAP NORMAL
- ΠΩΜΑ NORMAL LINDNER

PRODUCTION MATERIAL: **PORCELAIN & METALLIC**  
ΥΛΙΚΟ ΚΑΤΑΣΚΕΥΗΣ: **ΠΟΡΣΕΛΑΝΗ & ΜΕΤΑΛΛΙΚΟ**

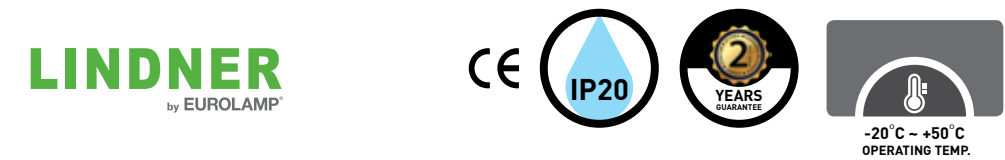

BARCODE	CODE	AMPER	∅ mm	↑ mm	PACKING	PRICE (€)
5207227006630	147-61512	25A	33,5	43	1/10/300	0.92
5207227006647	147-61513	63A	42	43	1/10/300	1.10
5207227006654	147-61514	100A	61	54	1/8/80	2.85

- LINDNER COVER NORMAL
- ΚΑΛΥΜΜΑΤΑ NORMAL LINDNER

PRODUCTION MATERIAL: **PLASTIC**  
ΥΛΙΚΟ ΚΑΤΑΣΚΕΥΗΣ: **ΠΛΑΣΤΙΚΟ**

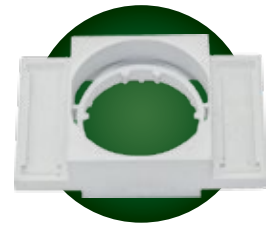

**LINDNER**  
by EUROLAMP



BARCODE	CODE	AMPER	←→ mm	↑ mm	↗ mm	PACKING	PRICE (€)
5207227006692	147-61522	25A	80,5	22,5	39	1/6	0.44
5207227006708	147-61523	63A	81	23	49	1/10	0.46

- LINDNER NEOZET SET
- ΝΕΟΖΕΤ ΠΛΗΡΗΣ LINDNER

PRODUCTION MATERIAL: **PORCELAIN, PLASTIC & METALLIC**  
ΥΛΙΚΟ ΚΑΤΑΣΚΕΥΗΣ: **ΠΟΡΣΕΛΑΝΗ, ΠΛΑΣΤΙΚΟ & ΜΕΤΑΛΛΙΚΟ**



**LINDNER**  
by EUROLAMP



BARCODE	CODE	AMPER	←→ mm	↑ mm	↗ mm	PACKING	PRICE (€)
5207227006715	147-61550	35A	72	67	27	1/10/100	3.96

- LINDNER CAP DEH
- ΠΩΜΑ ΔΕΗ LINDNER

PRODUCTION MATERIAL: **PORCELAIN & METALLIC**  
ΥΛΙΚΟ ΚΑΤΑΣΚΕΥΗΣ: **ΠΟΡΣΕΛΑΝΗ & ΜΕΤΑΛΛΙΚΟ**



**LINDNER**  
by EUROLAMP



BARCODE	CODE	AMPER	∅ mm	↑ mm	PACKING	PRICE (€)
5207227006661	147-61515	30-50A	24	37,5	1/20/600	0.78



- Πίνακες / Γέφυρες χαλκού / Μετρητές ρεύματος / Φις Βιομηχανικού τύπου  
Πρίζες Βιομηχανικού τύπου / Χρονοδιακόπτες ρεύματος
- Fuses Boxes / Busbar Copper / Din rail electric meter / Industrial type plugs  
Industrial type socket / Electric timer switch

Discover our Collection ►

- FUSE BOXES / WITHOUT DOOR
- ΠΙΝΑΚΕΣ ΕΙΩΤΕΡΙΚΟΙ / ΧΩΡΙΣ ΠΟΡΤΑ



COLOR: **WHITE** ΧΡΩΜΑ: **ΛΕΥΚΟ**

PRODUCTION MATERIAL: **ABS**

ΥΛΙΚΟ ΚΑΤΑΣΚΕΥΗΣ: **ABS πλαστικό**



BARCODE	CODE	DESCRIPTION	↔ mm	↑ mm	↗ mm	PACKING	PRICE (€)
5206139022905	147-31000	1-2 ΘΕΣΕΩΝ / 1-2M	50	60	125	1/20	0.98
5206139022929	147-31001	2-4 ΘΕΣΕΩΝ / 2-4M	85	60	125	1/10	1.39

- FUSE BOXES / WITH DOOR
- ΠΙΝΑΚΕΣ ΕΙΩΤΕΡΙΚΟΙ / ΜΕ ΠΟΡΤΑ



COLOR: **WHITE** ΧΡΩΜΑ: **ΛΕΥΚΟ**

PRODUCTION MATERIAL: **ABS**

ΥΛΙΚΟ ΚΑΤΑΣΚΕΥΗΣ: **ABS πλαστικό**



BARCODE	CODE	DESCRIPTION	↔ mm	↑ mm	↗ mm	PACKING	PRICE (€)
5207227077579	147-31009	2 ΘΕΣΕΩΝ / 2M	140	70	130	1/20	3.95
5206139037084	147-31002	4 ΘΕΣΕΩΝ / 4M	140	70	130	1/20	4.56
5206139022936	147-31003	6 ΘΕΣΕΩΝ / 6M	170	95	130	1/20	6.36
5206139022950	147-31005	12 ΘΕΣΕΩΝ / 12M	300	100	195	1/10	8.95
5206139022981	147-31007	24 ΘΕΣΕΩΝ / 24M	300	100	325	1/5	15.90
5206139022998	147-31008	36 ΘΕΣΕΩΝ / 36M	300	100	460	1/5	19.85

- FUSE BAR • ΜΠΑΡΑ ΑΣΦΑΛΕΙΩΝ

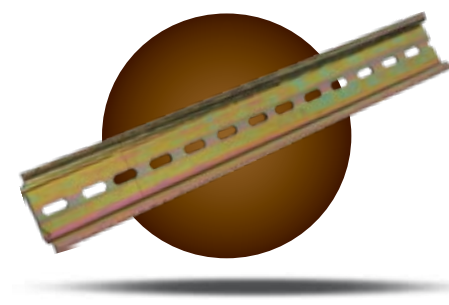

COLOR: **BRASS** ΧΡΩΜΑ: **ΜΠΡΟΥΤΖΙΝΟ**

PRODUCTION MATERIAL: **IRON**

ΥΛΙΚΟ ΚΑΤΑΣΚΕΥΗΣ: **ΣΙΔΕΡΟ**



BARCODE	CODE	DESCRIPTION	↑ mm	↗ mm	↔	PACKING	PRICE (€)
5207227022722	147-08010	ΜΠΑΡΑ ΑΣΦΑΛΕΙΩΝ 1M ΩΜΕΓΑ FUSE BAR 1M OMEGA	7,5	35	1000	1/20/100	1.63

- FUSE BOXES MOUNTING / WITH DOOR
- ΠΙΝΑΚΕΣ ΧΩΝΕΥΤΟΙ / ΜΕ ΠΟΡΤΑ



COLOR: **WHITE** ΧΡΩΜΑ: **ΛΕΥΚΟ**

PRODUCTION MATERIAL: **ABS**

ΥΛΙΚΟ ΚΑΤΑΣΚΕΥΗΣ: **ABS πλαστικό**



BARCODE	CODE	DESCRIPTION	↔ mm	↑ mm	↗ mm	PACKING	PRICE (€)
5206139005595	147-31013	12 ΘΕΣΕΩΝ / 12M	300	100	195	1/10	8.95
5206139005663	147-31015	24 ΘΕΣΕΩΝ / 24M	300	100	325	1/5	15.90
5206139005670	147-31016	36 ΘΕΣΕΩΝ / 36M	300	100	460	1/5	19.87

- COPPER BUSBARS U TYPE • ΓΕΦΥΡΕΣ ΧΑΛΚΟΥ ΤΥΠΟΥ U

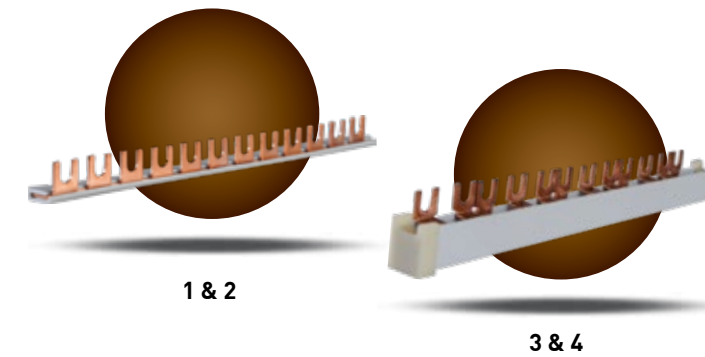

COLOR: **WHITE** ΧΡΩΜΑ: **ΛΕΥΚΟ**

PRODUCTION MATERIAL: **PVC & COPPER**

ΥΛΙΚΟ ΚΑΤΑΣΚΕΥΗΣ: **PVC & ΧΑΛΚΟΣ**



BARCODE	CODE	DESCRIPTION	↑ mm	↗ mm	↔	PACKING	PRICE (€)
1 5206139022745	147-08001	1P 12Θ ΜΕ ΜΟΝΩΣΗ 220-240V 1P 12 SEATS WITH INSULATION 220-240V	14,43	14,55	215	1/20/250	2.05
2 5206139203007	147-08000	1P 1m ΜΕ ΜΟΝΩΣΗ 220-240V 1P 1m WITH INSULATION 220-240V	14,43	14,55	1000	1/10/100	8.45
3 5206139203038	147-08003	3P 12Θ ΜΕ ΜΟΝΩΣΗ 415V 3P 12 SEATS WITH INSULATION 415V	25,09	15,23	215	1/10/150	4.85
4 5206139203021	147-08002	3P 1m ΜΕ ΜΟΝΩΣΗ 415V 3P 1m WITH INSULATION 415V	25,09	15,23	1000	1/5/50	18.90

- COPPER BUSBARS L TYPE
- ΓΕΦΥΡΕΣ ΧΑΛΚΟΥ ΤΥΠΟΥ L

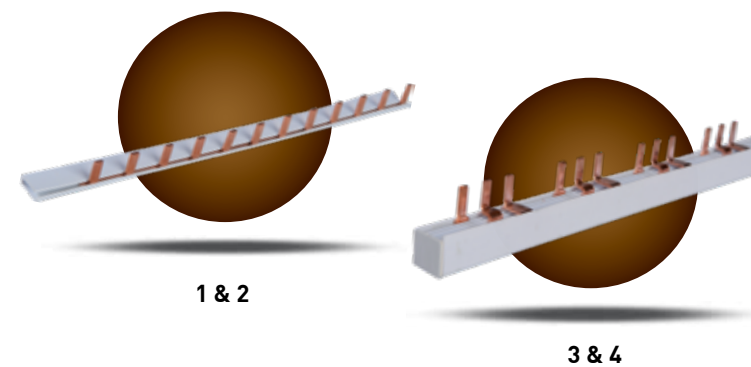

COLOR: **WHITE** ΧΡΩΜΑ: **ΛΕΥΚΟ**

PRODUCTION MATERIAL: **PVC & COPPER**

ΥΛΙΚΟ ΚΑΤΑΣΚΕΥΗΣ: **PVC & ΧΑΛΚΟΣ**



BARCODE	CODE	DESCRIPTION	↑ mm	↗ mm	↔	PACKING	PRICE (€)
1 5206139203052	147-08005	1P 12Θ ΜΕ ΜΟΝΩΣΗ 220-240V 1P 12 SEATS WITH INSULATION 220-240V	14,43	14,55	215	1/20/400	2.05
2 5206139203083	147-08008	1P 1m ΜΕ ΜΟΝΩΣΗ 220-240V 1P 1m WITH INSULATION 220-240V	14,43	14,55	1000	1/20/100	7.55
3 5206139022769	147-08007	3P 12Θ ΜΕ ΜΟΝΩΣΗ 415V 3P 12 SEATS WITH INSULATION 415V	25,09	15,23	215	1/10/100	4.55
4 5206139203090	147-08009	3P 1m ΜΕ ΜΟΝΩΣΗ 415V 3P 1m WITH INSULATION 415V	25,09	15,23	1000	1/10/50	18.75

- PLUGS MALE / INDUSTRIAL TYPE
- ΦΙΣ ΑΡΣΕΝΙΚΑ / ΒΙΟΜΗΧΑΝΙΚΟΥ ΤΥΠΟΥ

PRODUCTION MATERIAL: **PVC & COPPER**  
ΥΛΙΚΟ ΚΑΤΑΣΚΕΥΗΣ: **PVC & ΧΑΛΚΟΣ**

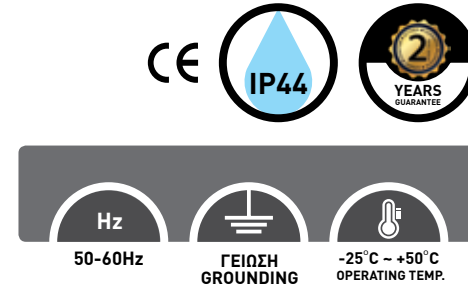
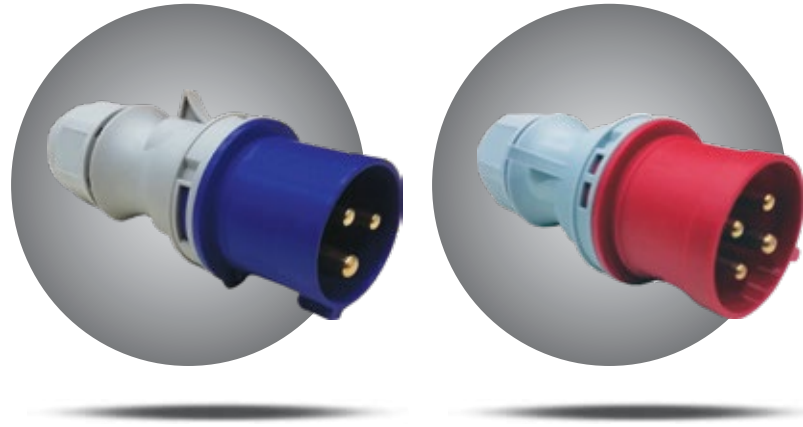

BARCODE	CODE	DESCRIPTION	COLOR	∅ mm	↑ mm	PACKING	PRICE (€)
5207227077098	147-16500	3x16A 220-240V	BLUE & GREY	50	140	1/10/100	3.78
5207227077104	147-16501	3X32A 220-240V	BLUE & GREY	70	165	1/10/60	5.74
5207227077111	147-16502	4X16A 380-415V	RED & GREY	70	145	1/10/60	4.33
5207227077128	147-16503	5X16A 380-415V	RED & GREY	70	145	1/10/60	4.97
5207227077135	147-16504	4X32A 380-415V	RED & GREY	75	160	1/10/60	6.98
5207227077142	147-16505	5X32A 380-415V	RED & GREY	80	170	1/10/60	7.79

- PLUGS FEMALE / INDUSTRIAL TYPE
- ΦΙΣ ΘΗΛΥΚΑ / ΒΙΟΜΗΧΑΝΙΚΟΥ ΤΥΠΟΥ

PRODUCTION MATERIAL: **PVC & COPPER**  
ΥΛΙΚΟ ΚΑΤΑΣΚΕΥΗΣ: **PVC & ΧΑΛΚΟΣ**

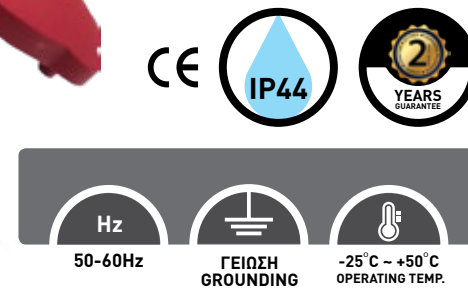
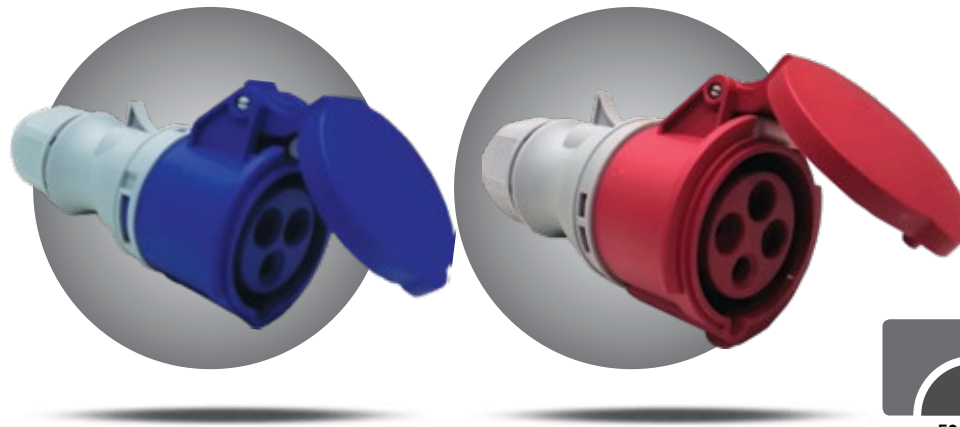

BARCODE	CODE	DESCRIPTION	COLOR	∅ mm	↑ mm	PACKING	PRICE (€)
5207227077159	147-16510	3x16A 220-240V	BLUE & GREY	80	145	1/10/100	4.43
5207227077166	147-16511	3X32A 220-240V	BLUE & GREY	90	170	1/10/60	6.72
5207227077173	147-16512	4X16A 380-415V	RED & GREY	80	150	1/10/60	5.42
5207227077180	147-16513	5X16A 380-415V	RED & GREY	90	150	1/10/60	5.98
5207227077197	147-16514	4X32A 380-415V	RED & GREY	95	170	1/10/60	7.86
5207227077220	147-16515	5X32A 380-415V	RED & GREY	105	180	1/10/60	8.88

- WALL MOUNTED SOCKETS / INDUSTRIAL TYPE
- ΠΡΙΖΕΣ ΕΠΙΤΟΙΧΕΣ / ΒΙΟΜΗΧΑΝΙΚΟΥ ΤΥΠΟΥ

PRODUCTION MATERIAL: **PVC & COPPER**  
ΥΛΙΚΟ ΚΑΤΑΣΚΕΥΗΣ: **PVC & ΧΑΛΚΟΣ**

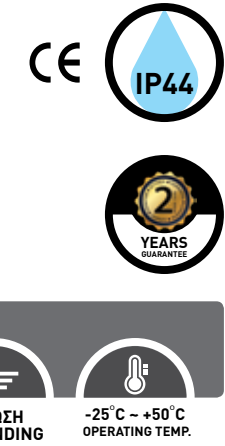

BARCODE	CODE	DESCRIPTION	COLOR	↑ mm	↗ mm	↔ mm	PACKING	PRICE (€)
5207227077258	147-16520	3x16A 220-240V	BLUE & GREY	110	80	140	1/10/60	5.76
5207227077279	147-16521	3X32A 220-240V	BLUE & GREY	110	85	155	1/10/60	7.86
5207227077319	147-16522	4X16A 380-415V	RED & GREY	100	80	145	1/10/60	6.34
5207227077340	147-16523	5X16A 380-415V	RED & GREY	100	80	150	1/10/60	6.62
5207227077378	147-16524	4X32A 380-415V	RED & GREY	110	80	160	1/10/60	8.89
5207227077388	147-16525	5X32A 380-415V	RED & GREY	115	80	155	1/10/60	9.58



- DIN RAIL ELECTRIC METERS ANALOG 1 PHASE
- ΜΕΤΡΗΤΕΣ ΡΕΥΜΑΤΟΣ ΡΑΓΑΣ ΑΝΑΛΟΓΙΚΟΣ ΜΟΝΟΦΑΣΙΚΟΣ

PRODUCTION MATERIAL: **ABS & PLASTIC**  
ΥΛΙΚΟ ΚΑΤΑΣΚΕΥΗΣ: **ABS & ΠΛΑΣΤΙΚΟ**



BARCODE	CODE	DESCRIPTION	WEIGHT	mm	mm	mm	PACKING	PRICE (€)
5206139210043	147-02054	ΣΤΕΝΟΣ / NARROW 30A	0,099kg	60	91	17	1/10/100	23.75
5206139210050	147-02055	ΦΑΡΔΥΣ / WIDE 50A	0,242kg	48	85	73	1/60	21.65



- SOCKET METER 1 PHASE
- ΜΕΤΡΗΤΗΣ ΡΕΥΜΑΤΟΣ ΠΡΙΖΑΣ

PRODUCTION MATERIAL: **ABS & PLASTIC**  
ΥΛΙΚΟ ΚΑΤΑΣΚΕΥΗΣ: **ABS & ΠΛΑΣΤΙΚΟ**

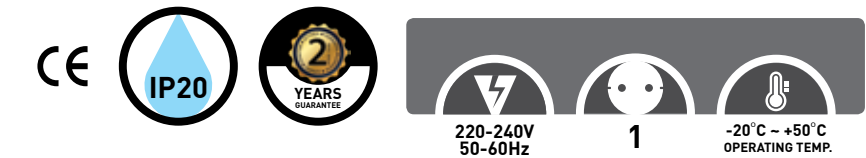

BARCODE	CODE	AMBER	WEIGHT	mm	mm	mm	PACKING	PRICE (€)
5206139210081	147-02058	16A	0,248kg	55	115	80	1/20	29.65



- DIN RAIL ELECTRIC METERS DIGITAL 1 PHASE
- ΜΕΤΡΗΤΕΣ ΡΕΥΜΑΤΟΣ ΡΑΓΑΣ ΨΗΦΙΑΚΟΣ ΜΟΝΟΦΑΣΙΚΟΣ

PRODUCTION MATERIAL: **ABS & PLASTIC**  
ΥΛΙΚΟ ΚΑΤΑΣΚΕΥΗΣ: **ABS & ΠΛΑΣΤΙΚΟ**



BARCODE	CODE	DESCRIPTION	WEIGHT	mm	mm	mm	PACKING	PRICE (€)
5206139210098	147-02060	ΣΤΕΝΟΣ / NARROW 30A	0,092kg	60	91	17	1/10/100	20.65
5206139210104	147-02061	ΦΑΡΔΥΣ / WIDE 50A	0,261kg	62	100	73	1/60	24.90



- ELECTRIC METER ANALOG 1 PHASE
- ΜΕΤΡΗΤΗΣ ΡΕΥΜΑΤΟΣ ΑΝΑΛΟΓΙΚΟΣ ΜΟΝΟΦΑΣΙΚΟΣ

PRODUCTION MATERIAL: **STEEL & PLASTIC**  
ΥΛΙΚΟ ΚΑΤΑΣΚΕΥΗΣ: **ΑΤΣΑΛΙ & ΠΛΑΣΤΙΚΟ**



BARCODE	CODE	AMBER	WEIGHT	mm	mm	mm	PACKING	PRICE (€)
5206139210005	147-02050	30A	0,916kg	161	106	114	1/12	15.25



- DIN RAIL ELECTRIC METER DIGITAL 3 PHASES
- ΜΕΤΡΗΤΗΣ ΡΕΥΜΑΤΟΣ ΡΑΓΑΣ ΨΗΦΙΑΚΟΣ ΤΡΙΦΑΣΙΚΟΣ

PRODUCTION MATERIAL: **ABS & PLASTIC**  
ΥΛΙΚΟ ΚΑΤΑΣΚΕΥΗΣ: **ABS & ΠΛΑΣΤΙΚΟ**



BARCODE	CODE	AMBER	WEIGHT	mm	mm	mm	PACKING	PRICE (€)
5206139210074	147-02057	3/90A	0,492kg	63	100	122	1/32	59.25



- ELECTRIC METERS ANALOG 3 PHASES
- ΜΕΤΡΗΤΕΣ ΡΕΥΜΑΤΟΣ ΑΝΑΛΟΓΙΚΟΣ ΤΡΙΦΑΣΙΚΟΣ

PRODUCTION MATERIAL: **STEEL & PLASTIC**  
ΥΛΙΚΟ ΚΑΤΑΣΚΕΥΗΣ: **ΑΤΣΑΛΙ & ΠΛΑΣΤΙΚΟ**



BARCODE	CODE	AMBER	WEIGHT	mm	mm	mm	PACKING	PRICE (€)
5206139210012	147-02051	3/40A	3,000kg	274	122	167	1/6	46.35
5206139210029	147-02052	3/60A	3,000kg	274	122	167	1/6	48.80
5206139210036	147-02053	3/90A	3,000kg	274	122	167	1/6	51.85





• TIMER SWITCH WIDE DIGITAL  
• ΧΡΟΝΟΔΙΑΚΟΠΤΗΣ ΡΑΓΑΣ ΦΑΡΔΥΣ ΨΗΦΙΑΚΟΣ

PRODUCTION MATERIAL: **ABS & PLASTIC**  
ΥΛΙΚΟ ΚΑΤΑΣΚΕΥΗΣ: **ABS & ΠΛΑΣΤΙΚΟ**



BARCODE	CODE	WATT	WEIGHT	mm	mm	mm	PACKING	PRICE (€)
5207227013324	147-35011	200W LED (MAX)	0,120kg	66	36	86	1/100	18.50



• TIMER SWITCH NARROW  
• ΧΡΟΝΟΔΙΑΚΟΠΤΗΣ ΡΑΓΑΣ ΣΤΕΝΟΣ

PRODUCTION MATERIAL: **ABS & PLASTIC**  
ΥΛΙΚΟ ΚΑΤΑΣΚΕΥΗΣ: **ABS & ΠΛΑΣΤΙΚΟ**

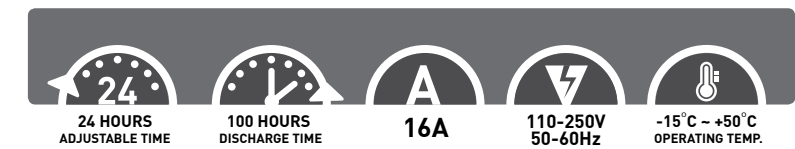

BARCODE	CODE	WATT	WEIGHT	mm	mm	mm	PACKING	PRICE (€)
5207227013294	147-35010	150W LED (MAX)	0,073kg	60	18	90	1/100	17.65



• TIMER SWITCH SURFACE  
• ΧΡΟΝΟΔΙΑΚΟΠΤΗΣ ΕΞΩΤΕΡΙΚΟΣ

PRODUCTION MATERIAL: **ABS & PLASTIC**  
ΥΛΙΚΟ ΚΑΤΑΣΚΕΥΗΣ: **ABS & ΠΛΑΣΤΙΚΟ**

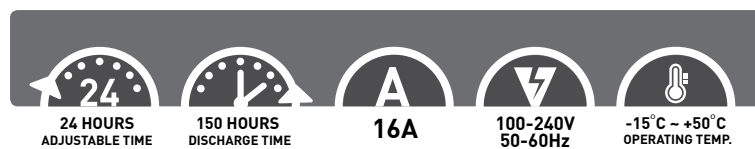

BARCODE	CODE	WATT	WEIGHT	mm	mm	mm	PACKING	PRICE (€)
5207227013331	147-35012	150W LED (MAX)	0,250kg	51,5	83,5	112	1/50	30.50



• AUTOMATIC TIMER STAIRWELL  
• ΑΥΤΟΜΑΤΟΣ ΚΛΙΜΑΚΟΣΤΑΣΙΟΥ

PRODUCTION MATERIAL: **ABS & PLASTIC**  
ΥΛΙΚΟ ΚΑΤΑΣΚΕΥΗΣ: **ABS & ΠΛΑΣΤΙΚΟ**

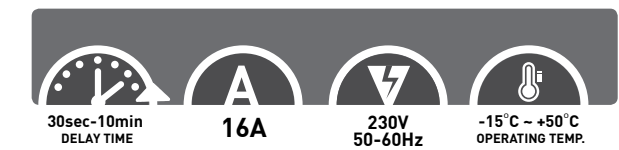

BARCODE	CODE	WATT	WEIGHT	mm	mm	mm	PACKING	PRICE (€)
5207227013317	147-64000	200W LED (MAX)	0,072kg	60	18	83	1/6/240	12.45



• TIMER SWITCH 24 HOURS  
• ΧΡΟΝΟΔΙΑΚΟΠΤΗΣ ΠΡΙΖΑΣ 24ΩΡΕΣ

PRODUCTION MATERIAL: **PLASTIC & COPPER**  
ΥΛΙΚΟ ΚΑΤΑΣΚΕΥΗΣ: **ΠΛΑΣΤΙΚΟ & ΧΑΛΚΙΝΟ**



• Αλλαγή ρύθμισης μετά την πάροδο 30 min από την προηγούμενη  
• Adjustment change after 30 min from previous

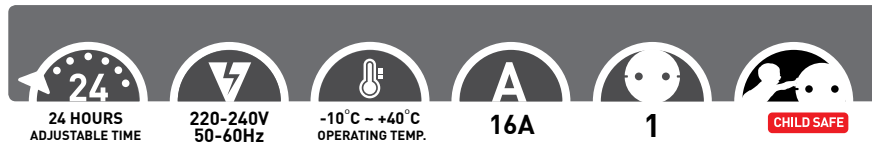

BARCODE	CODE	WATT	WEIGHT	mm	mm	mm	PACKING	PRICE (€)
5206139230003	147-35000	3680W	0,180kg	105	77	56	1/12/48	4.65

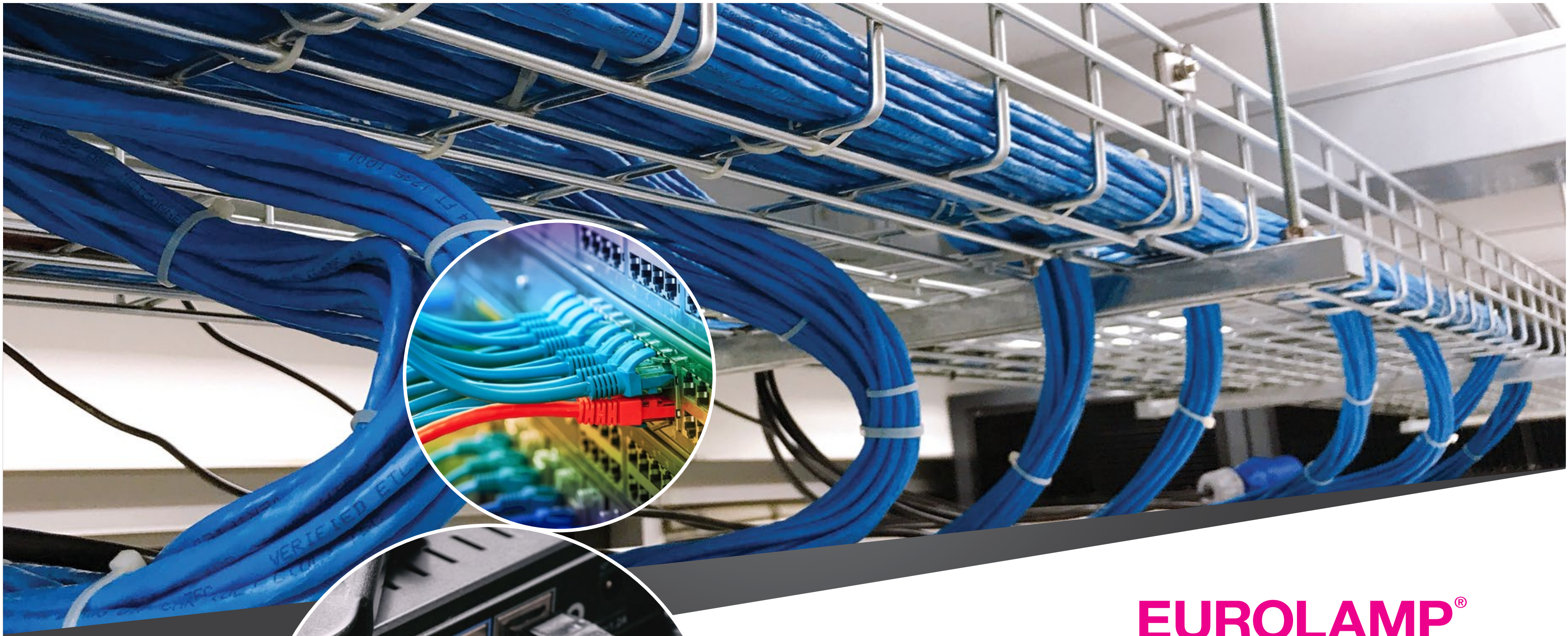

# EUROLAMP®

Electrical Equipment

- Καλώδια Τηλεφώνου / Καλώδια Δικτύου / Καλώδια Τηλεόρασης / Καλώδια Ηχείων / Καλώδια Συναγερμού / Εξαρτήματα
- Telephone cables / Network cables / TV cables / Speaker cables / Alarm cables / Accessories

Discover our Collection ►

• MODULAR TELEPHONE PLUGS • ΦΙΣ ΤΗΛΕΦΩΝΟΥ Α.Τ.

PRODUCTION MATERIAL: **COPPER & PLASTIC**  
ΥΛΙΚΟ ΚΑΤΑΣΚΕΥΗΣ: **ΧΑΛΚΟΣ & ΠΛΑΣΤΙΚΟ**

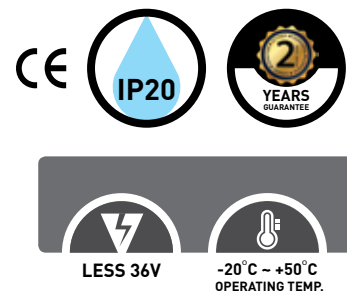
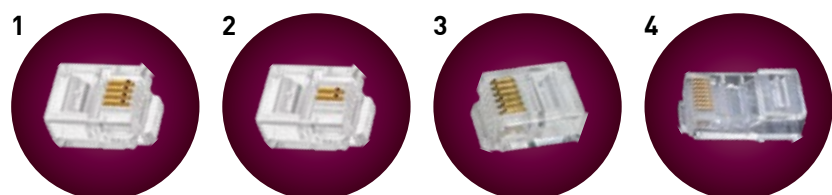

	BARCODE	CODE	DESCRIPTION	PACKING	PRICE (€)
1	5206139107008	147-10050	4P4C	100\1000\25000	0.03
2	5206139107015	147-10051	4P2C	100\1000\25000	0.03
3	5206139107022	147-10052	6P4C	100\1000\20000	0.05
4	5206139107039	147-10053	UTP Cat.5 8P8C	100\1000\10000	0.07

• TELEPHONE ADAPTORS & CONNECTORS  
• ΑΝΤΑΠΤΟΡΕΣ ΤΗΛΕΦΩΝΟΥ & ΣΥΝΔΕΣΜΟΙ

PRODUCTION MATERIAL: **COPPER & PLASTIC**  
ΥΛΙΚΟ ΚΑΤΑΣΚΕΥΗΣ: **ΧΑΛΚΟΣ & ΠΛΑΣΤΙΚΟ**

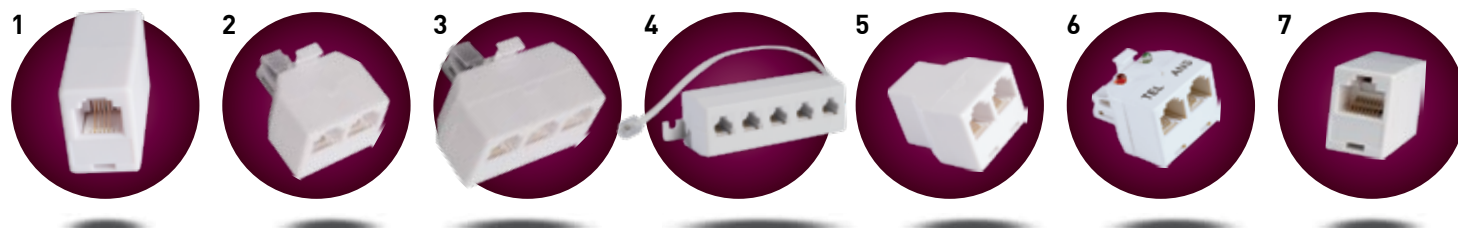

	BARCODE	CODE	DESCRIPTION	PACKING	PRICE (€)
1	5206139107046	147-10054	ΕΝΩΤΙΚΟΣ ΣΥΝΔΕΣΜΟΣ 6P4C / MODULAR CORD COUPLER 6P4C	1/50/1000	0.41
2	5206139107053	147-10055	ΑΡΣΕΝΙΚΟ ΣΕ 2 ΘΗΛΥΚΑ 6P4C / MALE TO 2 FEMALE 6P4C	1/500	0.51
3	5206139107060	147-10056	ΑΡΣΕΝΙΚΟ ΣΕ 3 ΘΗΛΥΚΑ 6P4C / MALE TO 3 FEMALE 6P4C	1/500	0.72
4	5206139107077	147-10057	ΑΡΣΕΝΙΚΟ ΣΕ 5 ΘΗΛΥΚΑ 6P4C / MALE TO 5 FEMALE 6P4C	1/250	1.92
5	5206139107091	147-10059	ΘΗΛΥΚΟ ΣΕ 2 ΘΗΛΥΚΑ 6P4C / FEMALE TO 2 FEMALE 6P4C	1\25\250\1000	0.56
6	5206139107381	147-10090	ΑΡΣΕΝΙΚΟ ΣΕ 2 ΘΗΛΥΚΑ 2 ΓΡΑΜΜΩΝ 6P4C MALE TO 2 FEMALE 2 LINE 6P4C	1\500	1.28
7	5206139107404	147-10091	* ΕΝΩΤΙΚΟΣ ΣΥΝΔΕΣΜΟΣ ΔΙΚΤΥΟΥ 8P8C MODULAR CORD COUPLER 8P8C	1\100\1000	0.44

• EXTENSION TELEPHONE CORDS • ΠΡΟΕΚΤΑΣΕΙΣ ΤΗΛΕΦΩΝΟΥ

PRODUCTION MATERIAL: **COPPER & PLASTIC**  
ΥΛΙΚΟ ΚΑΤΑΣΚΕΥΗΣ: **ΧΑΛΚΟΣ & ΠΛΑΣΤΙΚΟ**

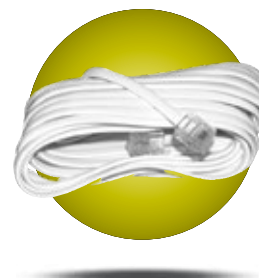

BARCODE	CODE	COLOR	LENGTH	PACKING	PRICE (€)
5206139107121	147-10062	WHITE	3m	1/200	0.72
5206139107138	147-10063	WHITE	5m	1/200	1.08
5206139107183	147-10070	BLACK	3m	1/10/200	0.72
5206139107244	147-10074	WHITE	10m	1/10/300	1.52

• TELEPHONE SPIRAL • ΣΠΙΡΑΛ ΤΗΛΕΦΩΝΟΥ

PRODUCTION MATERIAL: **COPPER & PLASTIC**  
ΥΛΙΚΟ ΚΑΤΑΣΚΕΥΗΣ: **ΧΑΛΚΟΣ & ΠΛΑΣΤΙΚΟ**

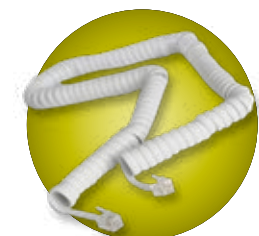

BARCODE	CODE	COLOR	LENGTH	PACKING	PRICE (€)
5206139107145	147-10064	WHITE	2m	1/200	0.72
5206139107152	147-10065	WHITE	4m	1/200	0.92
5206139107169	147-10066	BLACK	2m	1/200	0.72
5206139107206	147-10069	BLACK	4m	1/10/200	0.92

• TELEPHONE SOCKETS • ΠΡΙΖΕΣ ΤΗΛΕΦΩΝΟΥ

PRODUCTION MATERIAL: **COPPER & PLASTIC**  
ΥΛΙΚΟ ΚΑΤΑΣΚΕΥΗΣ: **ΧΑΛΚΟΣ & ΠΛΑΣΤΙΚΟ**



BARCODE	CODE	DESCRIPTION	PACKING	PRICE (€)
5206139107398	147-16050	ΜΟΝΗ 6P4C / SINGLE 6P4C / RJ11	1/500	0.68
5206139107411	147-16051	ΔΙΠΛΗ 6P4C / DOUBLE 6P4C / RJ11	1/500	0.88
5207227016141	147-16052	ΜΟΝΗ RG45 CAT5e / SINGLE RG45 CAT5e	1/500	1.54
5207227016172	147-16053	ΔΙΠΛΗ RG45 CAT5e / DOUBLE RG45 CAT5e	1/250	2.56
5207227016158	147-16054	ΜΟΝΗ RG45 CAT6e / SINGLE RG45 CAT6e	1/500	1.68
5207227016202	147-16055	ΔΙΠΛΗ RG45 CAT6e / DOUBLE RG45 CAT6e	1/250	2.78

- TELEPHONE FILTER ADSL & SPLITTER
- ΦΙΛΤΡΟ ΓΡΑΜΜΗΣ ADSL & SPLITTER



PRODUCTION MATERIAL: **COPPER & PLASTIC**  
ΥΛΙΚΟ ΚΑΤΑΣΚΕΥΗΣ: **ΧΑΛΚΟΣ & ΠΛΑΣΤΙΚΟ**

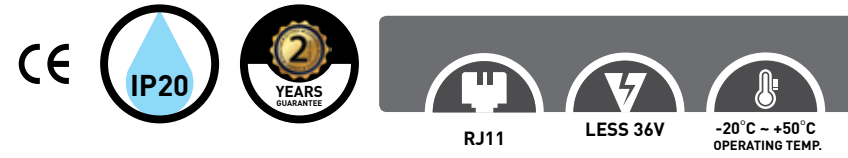

BARCODE	CODE	DESCRIPTION	PACKING	PRICE (€)
5206139091260	147-16021	ΦΙΛΤΡΟ ΓΡΑΜΜΗΣ ADSL & SPLITTER TELEPHONE FILTER ADSL & SPLITTER	1/10/500	2.65

- TELEPHONE CABLES FLAT 2 PAIR • ΚΑΛΩΔΙΑ ΤΗΛΕΦΩΝΟΥ ΠΛΑΚΕ 2 ΖΕΥΓΩΝ

PRODUCTION MATERIAL: **COPPER & PLASTIC**  
ΥΛΙΚΟ ΚΑΤΑΣΚΕΥΗΣ: **ΧΑΛΚΟΣ & ΠΛΑΣΤΙΚΟ**

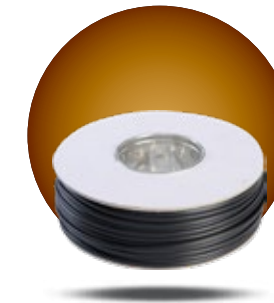

BARCODE	CODE	COLOR	LENGTH	PACKING	PRICE (€)
5206139200006	147-13100	WHITE	100m	100/1000	0.13
5206139200105	147-13110	BLACK	100m	100/1000	0.13

- DISCONNECTION MODULES
- ΟΡΙΟΛΩΡΙΔΕΣ

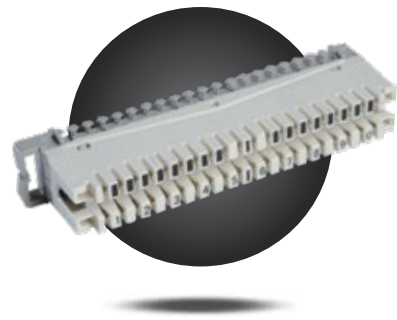

PRODUCTION MATERIAL: **COPPER & PLASTIC**  
ΥΛΙΚΟ ΚΑΤΑΣΚΕΥΗΣ: **ΧΑΛΚΟΣ & ΠΛΑΣΤΙΚΟ**



BARCODE	CODE	DESCRIPTION	PACKING	PRICE (€)
5206139221001	147-02100	10 ΖΕΥΓΩΝ / 10 PAIRS	1/10/500	2.18

- PATCH CORDS UTP CAT.5e • ΠΡΟΕΚΤΑΣΕΙΣ ΔΙΚΤΥΟΥ UTP CAT.5e

PRODUCTION MATERIAL: **COPPER & PLASTIC**  
ΥΛΙΚΟ ΚΑΤΑΣΚΕΥΗΣ: **ΧΑΛΚΟΣ & ΠΛΑΣΤΙΚΟ**



BARCODE	CODE	COLOR	LENGTH	PACKING	PRICE (€)
5206139107503	147-10150	GREY	1m	1/200	0.86
5206139107510	147-10151	GREY	2m	1/200	1.18
5206139107527	147-10152	GREY	3m	1/100	1.46
5206139107534	147-10153	GREY	5m	1/100	1.72
5206139107541	147-10154	GREY	10m	1/50	3.35
5207227016301	147-10155	GREY	15m	1/30	5.45

- CRIMPING TELEPHONE TOOLS • ΠΡΕΣΕΣ ΤΗΛΕΦΩΝΟΥ

PRODUCTION MATERIAL: **COPPER & PLASTIC**  
ΥΛΙΚΟ ΚΑΤΑΣΚΕΥΗΣ: **ΧΑΛΚΟΣ & ΠΛΑΣΤΙΚΟ**

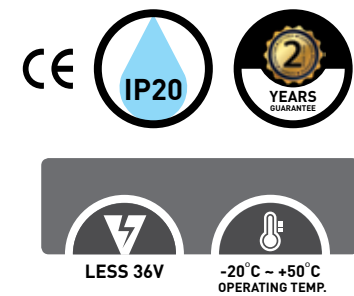
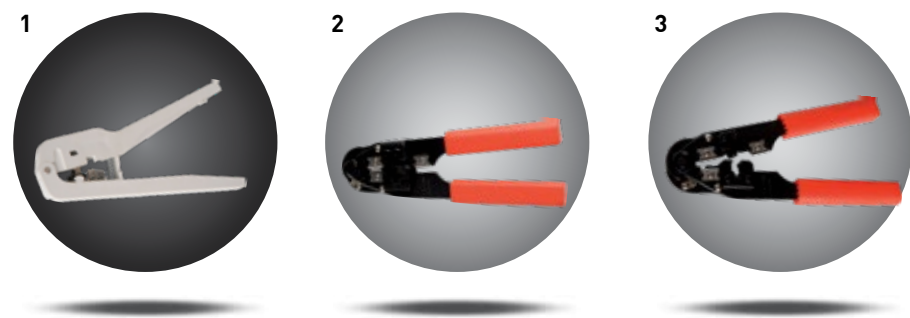

BARCODE	CODE	DESCRIPTION	PACKING	PRICE (€)
5206139107176	147-10067	ΠΛΑΣΤΙΚΗ / PLASTIC 4P4C 6P2C	1/10/100	3.35
5206139107190	147-10068	ΜΕΤΑΛΛΙΚΗ / METALLIC 8P8C	1/10/100	5.35
5206139107213	147-10071	ΜΕΤΑΛΛΙΚΗ / METALLIC 6P6C	1/10/200	5.30

- PATCH CORDS UTP CAT.6e • ΠΡΟΕΚΤΑΣΕΙΣ ΔΙΚΤΥΟΥ UTP CAT.6e

PRODUCTION MATERIAL: **COPPER & PLASTIC**  
ΥΛΙΚΟ ΚΑΤΑΣΚΕΥΗΣ: **ΧΑΛΚΟΣ & ΠΛΑΣΤΙΚΟ**



BARCODE	CODE	COLOR	LENGTH	PACKING	PRICE (€)
5207227016325	147-10170	GREY	0.50m	1/200	0.88
5207227016349	147-10171	GREY	1m	1/200	0.98
5207227016363	147-10172	GREY	2m	1/200	1.27
5207227016387	147-10173	GREY	3m	1/100	1.61
5207227016400	147-10174	GREY	5m	1/100	2.32
5207227016424	147-10175	GREY	10m	1/50	3.96
5207227016448	147-10176	GREY	15m	1/30	5.85

• CABLE UTP • ΚΑΛΩΔΙΟ UTP

PRODUCTION MATERIAL: **COPPER & PLASTIC**  
ΥΛΙΚΟ ΚΑΤΑΣΚΕΥΗΣ: **ΧΑΛΚΟΣ & ΠΛΑΣΤΙΚΟ**

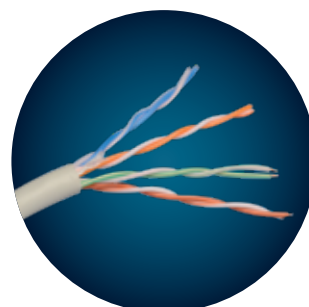

BARCODE	CODE	DESCRIPTION	LENGTH	PACKING	PRICE (€)
5206139200013	147-13101	CAT 5E 24AWG 4x2x0,51mm	305m	305/610	0.21

Αγωγού Υλικό: CCA Copper CLAD Aluminum Κατασκευή: 1/0. 505 +/- 0.015  
Πυκνότητα: 0.15mm Max AVG: 0.22 mm Διάμετρος: 0.96 +/- 0.02  
Επιμήκυνση: MIN 300% Αντοχή στον Εφελκυσμό: MIN 1.682Kg / min Προσάραξη  
Πολυεστέρας: 0,025 x 18mm AL FOIL: 0.035 x 18mm Σύρμα Απαγωγής: 1/0.40mm  
Περίβλημα Υλικό: LSOH Πυκνότητα: 0.40mm MAX AVG: 0.55mm  
Διάμετρος: 5.5 +/- 0.3 Χρώμα: Γκρι

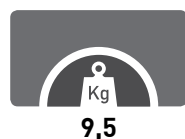

BARCODE	CODE	DESCRIPTION	LENGTH	PACKING	PRICE (€)
5206139200051	147-13105	CAT 6E 23AWG 4X2X0,574mm	305m	305/610	0.31

Καλώδιο patch CAT 6A S/FTP (PiMF).  
- Βύσμα 1: RJ45 (8P8C) male  
- Βύσμα 2: RJ45 (8P8C) male  
- Ιδανικό για δίκτυα: 10 Gigabit (10/100/1000/10000 Mbit)

- Μανδύας: PVC  
- Επιχρυσωμένες επαφές  
- Χρώμα: Γκρι

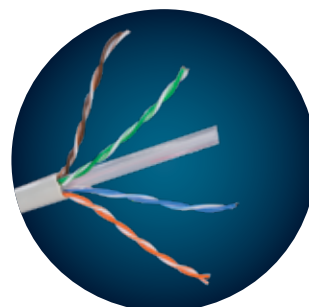

• CABLE FTP • ΚΑΛΩΔΙΟ FTP

PRODUCTION MATERIAL: **COPPER & PLASTIC**  
ΥΛΙΚΟ ΚΑΤΑΣΚΕΥΗΣ: **ΧΑΛΚΟΣ & ΠΛΑΣΤΙΚΟ**

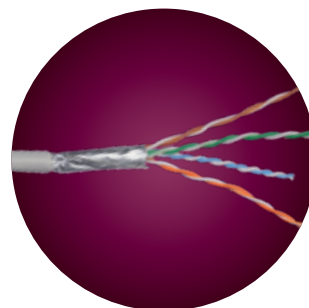

BARCODE	CODE	DESCRIPTION	LENGTH	PACKING	PRICE (€)
5206139200044	147-13104	CAT 5E 24AWG 4x2x0,51mm	305m	305/610	0.26

Αγωγού Υλικό: CCA Copper CLAD Aluminum Κατασκευή: 1/0. 505 +/- 0.015  
Πυκνότητα: 0.15mm Max AVG: 0.22 mm Διάμετρος: 0.96 +/- 0.02  
Επιμήκυνση: MIN 300% Αντοχή στον Εφελκυσμό: MIN 1.682Kg / min Προσάραξη  
Πολυεστέρας: 0,025 x 18mm AL FOIL: 0.035 x 18mm Σύρμα Απαγωγής: 1/0.40mm  
Περίβλημα Υλικό: LSOH Πυκνότητα: 0.40mm MAX AVG: 0.55mm  
Διάμετρος: 5.5 +/- 0.3 Χρώμα: Γκρι

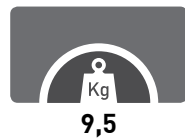

BARCODE	CODE	DESCRIPTION	LENGTH	PACKING	PRICE (€)
5206139200068	147-13106	CAT 6E 23AWG 4X2X0,574mm	305m	305/610	0.38

Καλώδιο patch CAT 6A S/FTP (PiMF).  
- Βύσμα 1: RJ45 (8P8C) male  
- Βύσμα 2: RJ45 (8P8C) male  
- Ιδανικό για δίκτυα: 10 Gigabit (10/100/1000/10000 Mbit)

- Μανδύας: PVC  
- Επιχρυσωμένες επαφές  
- Χρώμα: Γκρι

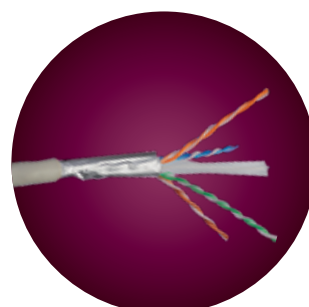

• CABLES HDMI • ΚΑΛΩΔΙΑ ΣΥΝΔΕΣΗΣ HDMI

PRODUCTION MATERIAL: **COPPER & PLASTIC**  
ΥΛΙΚΟ ΚΑΤΑΣΚΕΥΗΣ: **ΧΑΛΚΟΣ & ΠΛΑΣΤΙΚΟ**

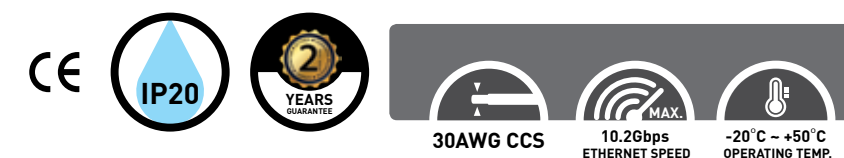

BARCODE	CODE	COLOR	LENGTH	PACKING	PRICE (€)
5206139101402	147-10140	BLACK	1m	1/150	2.16
5206139101419	147-10141	BLACK	2m	1/100	2.82
5206139101426	147-10142	BLACK	3m	1/100	3.26
5206139101433	147-10143	BLACK	5m	1/50	4.63
5206139101440	147-10144	BLACK	10m	1/30	9.68

• HDMI καλώδιο μήκους 1-3m: Υποστηρίζει συσκευές με μέγιστη ανάλυση: 2160p/  
HDMI cable 1-3m: Supports devices with maximum resolution: 2160p

• HDMI καλώδιο μήκους 5-10m: Υποστηρίζει συσκευές με μέγιστη ανάλυση: 1080p/  
HDMI cable 5-10m: Supports devices with maximum resolution: 1080p

• PLUGS TV • ΦΙΣ TV

PRODUCTION MATERIAL: **METALLIC & PLASTIC**  
ΥΛΙΚΟ ΚΑΤΑΣΚΕΥΗΣ: **ΜΕΤΑΛΛΙΚΟ & ΠΛΑΣΤΙΚΟ**

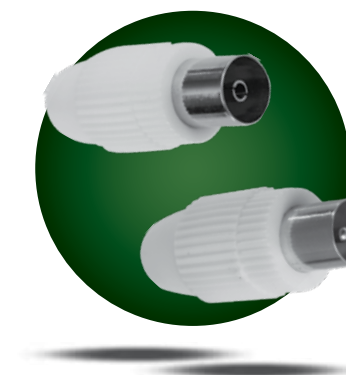

BARCODE	CODE	DESCRIPTION	PACKING	PRICE (€)
5206139104007	147-10100	ΑΡΣΕΝΙΚΟ / MALE	25/250/2000	0.19
5206139104014	147-10101	ΘΗΛΥΚΟ / FEMALE	25/250/2000	0.19

• PLUGS TV ANGLE • ΦΙΣ TV ΠΛΑΓΕΙΑΣ

PRODUCTION MATERIAL: **METALLIC & PLASTIC**  
ΥΛΙΚΟ ΚΑΤΑΣΚΕΥΗΣ: **ΜΕΤΑΛΛΙΚΟ & ΠΛΑΣΤΙΚΟ**



BARCODE	CODE	DESCRIPTION	PACKING	PRICE (€)
5206139104045	147-10104	ΑΡΣΕΝΙΚΟ / MALE	25/2000	0.19
5206139104052	147-10105	ΘΗΛΥΚΟ / FEMALE	25/2000	0.19

• ADAPTORS TV • ΤΑΦ TV

PRODUCTION MATERIAL: **METALLIC & PLASTIC**  
ΥΛΙΚΟ ΚΑΤΑΣΚΕΥΗΣ: **ΜΕΤΑΛΛΙΚΟ & ΠΛΑΣΤΙΚΟ**



BARCODE	CODE	DESCRIPTION	PACKING	PRICE (€)
5206139104021	147-10102	ΑΡΣΕΝΙΚΟ / MALE	25/250/1000	0.24
5206139104038	147-10103	ΘΗΛΥΚΟ / FEMALE	25/250/1000	0.24

• PLUGS TV F TYPE • ΦΙΣ TV ΤΥΠΟΥ F

PRODUCTION MATERIAL: **METALLIC**  
ΥΛΙΚΟ ΚΑΤΑΣΚΕΥΗΣ: **ΜΕΤΑΛΛΙΚΟ**



BARCODE	CODE	DESCRIPTION	PACKING	PRICE (€)
5206139104069	147-10106	ΦΙΣ ΜΕΤΑΛΛΙΚΟΥ ΤΥΠΟΥ F PLUG METALLIC F TYPE MALE	50/500/2000	0.09
5207227033209	147-10107	ΕΝΩΤΙΚΟ ΦΙΣ ΤΥΠΟΥ F PLUG CONNECTOR ZINC F TYPE	100/5000	0.16

• TV SPLITTERS TYPE F • ΔΙΑΚΛΑΔΩΤΕΣ TV ΤΥΠΟΥ F

PRODUCTION MATERIAL: **METALLIC**  
ΥΛΙΚΟ ΚΑΤΑΣΚΕΥΗΣ: **ΜΕΤΑΛΛΙΚΟ**



BARCODE	CODE	DESCRIPTION	LENGTH	WEIGHT	PACKING	PRICE (€)
5207227033230	147-10120	2 WAY - F 1/2	53mm	0,031kg	1/5/200	1.82
5207227033261	147-10121	3 WAY - F 1/3	72mm	0,032kg	1/5/200	2.40
5207227033292	147-10122	4 WAY - F 1/4	72mm	0,044kg	1/5/200	2.65
5207227033322	147-10123	6 WAY - F 1/6	116mm	0,110kg	1/5/100	6.25
5207227033353	147-10124	8 WAY - F 1/8	116mm	0,115kg	1/5/100	6.85

• SATELLITE SPLITTER TV-SAT TYPE F • ΜΙΚΤΗΣ TV-SAT ΤΥΠΟΥ F

PRODUCTION MATERIAL: **METALLIC**  
ΥΛΙΚΟ ΚΑΤΑΣΚΕΥΗΣ: **ΜΕΤΑΛΛΙΚΟ**



BARCODE	CODE	LENGTH	WEIGHT	PACKING	PRICE (€)
5207227033384	147-10125	59mm	0,044kg	1/5/250	2.55

• TV EXTENSION CABLES • ΠΡΟΕΚΤΑΣΕΙΣ TV

PRODUCTION MATERIAL: **COPPER & PLASTIC**  
ΥΛΙΚΟ ΚΑΤΑΣΚΕΥΗΣ: **ΧΑΛΚΟΣ & ΠΛΑΣΤΙΚΟ**

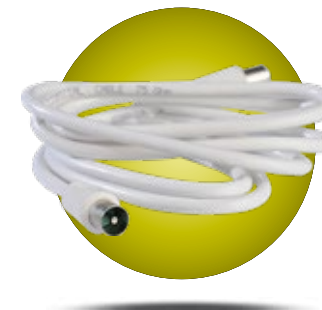
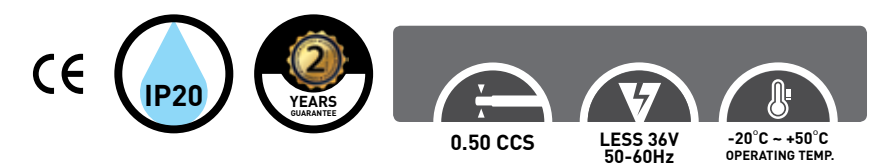

BARCODE	CODE	LENGTH	COLOR	PACKING	PRICE (€)
5206139200266	147-13126	1,5m	WHITE	1/10/250	0.96
5206139200273	147-13127	3m	WHITE	1/10/150	1.18
5207227016516	147-13128	1,5m	BLACK	1/10/250	0.96
5207227016530	147-13129	3m	BLACK	1/10/150	1.18

• SCART TO SCART • SCART ΣΕ SCART

PRODUCTION MATERIAL: **METALLIC & PLASTIC**  
ΥΛΙΚΟ ΚΑΤΑΣΚΕΥΗΣ: **ΜΕΤΑΛΛΙΚΟ & ΠΛΑΣΤΙΚΟ**



BARCODE	CODE	LENGTH	COLOR	PACKING	PRICE (€)
5206139104106	147-10110	1,5m	BLACK	1/100	1.72

• TV CABLES RG 6U • ΚΑΛΩΔΙΑ TV RG 6U



PRODUCTION MATERIAL: **COPPER & PLASTIC**  
ΥΛΙΚΟ ΚΑΤΑΣΚΕΥΗΣ: **ΧΑΛΚΟΣ & ΠΛΑΣΤΙΚΟ**

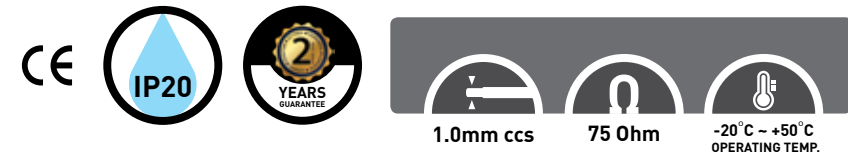

BARCODE	CODE	DESCRIPTION	WEIGHT	LENGTH	PACKING	PRICE (€)
5206139200556	147-13005	ΚΟΥΛΟΥΡΑ / COAXIAL	3,2kg	100m	100/500	0.20
5206139200570	147-13007	ΣΤΡΟΦΕΙΟ / COIL COAXIAL	16kg	500m	500	0.20

• TV SATELLITE CABLES RG 6U  
• ΚΑΛΩΔΙΑ TV ΔΟΡΥΦΟΡΙΚΑ RG 6U



PRODUCTION MATERIAL: **COPPER & PLASTIC**  
ΥΛΙΚΟ ΚΑΤΑΣΚΕΥΗΣ: **ΧΑΛΚΟΣ & ΠΛΑΣΤΙΚΟ**

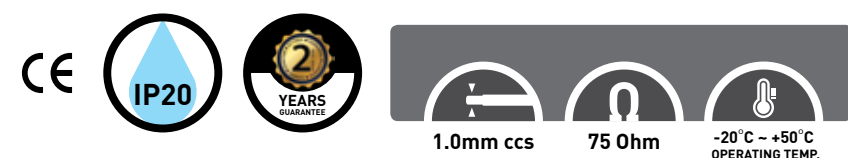

BARCODE	CODE	DESCRIPTION	WEIGHT	LENGTH	PACKING	PRICE (€)
5206139200549	147-13009	ΚΟΥΛΟΥΡΑ / COAXIAL	4,2kg	100m	100/500	0.32
5206139200563	147-13006	ΣΤΡΟΦΕΙΟ / COIL COAXIAL	20kg	500m	500	0.32

• CABLES CCTV • ΚΑΛΩΔΙΑ CCTV

PRODUCTION MATERIAL: **COPPER & PLASTIC**  
ΥΛΙΚΟ ΚΑΤΑΣΚΕΥΗΣ: **ΧΑΛΚΟΣ & ΠΛΑΣΤΙΚΟ**

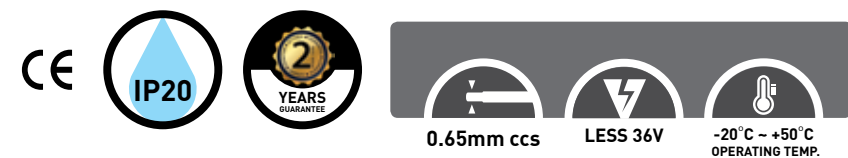

BARCODE	CODE	DESCRIPTION	LENGTH	PACKING	PRICE (€)
5207227016653	147-13140	RG59+2X0,50mm	100m	100/400	0.48
5207227016554	147-13141	RG59+2X0,50+2x0,22mm	100m	100/400	0.56

**- RG59+2X0,50mm**  
Καλώδιο Κάμερας, Μόνο Εικόνας  
Camera Cable, Image Only

**- RG59+2X0,50+2x0,22mm**  
Καλώδιο Κάμερας, Εικόνας και Ήχου  
Camera Cable, Image and Audio

• SPEAKER CABLES BLACK-RED  
• ΚΑΛΩΔΙΑ ΗΧΕΙΩΝ ΜΑΥΡΟ-ΚΟΚΚΙΝΟ

PRODUCTION MATERIAL: **COPPER & PLASTIC**  
ΥΛΙΚΟ ΚΑΤΑΣΚΕΥΗΣ: **ΧΑΛΚΟΣ & ΠΛΑΣΤΙΚΟ**



BARCODE	CODE	CABLE CROSS SECTION	WEIGHT	LENGTH	PACKING	PRICE (€)
5206139201560	147-13206	2x0,50mm	1,6kg	100m	100/500	0.14
5206139201577	147-13207	2x0,75mm	1,8kg	100m	100/500	0.18
5206139201584	147-13208	2x1mm	2kg	100m	100/500	0.24
5206139201591	147-13209	2X1,5mm	2,6kg	100m	100/500	0.33
5206139201607	147-13210	2X2,5mm	4kg	100m	100/500	0.52
5206139201614	147-13211	2X4mm	6kg	100m	100/300	0.76

• SPEAKER CABLES CLEAR  
• ΚΑΛΩΔΙΑ ΗΧΕΙΩΝ ΔΙΑΦΑΝΟ

PRODUCTION MATERIAL: **COPPER & PLASTIC**  
ΥΛΙΚΟ ΚΑΤΑΣΚΕΥΗΣ: **ΧΑΛΚΟΣ & ΠΛΑΣΤΙΚΟ**

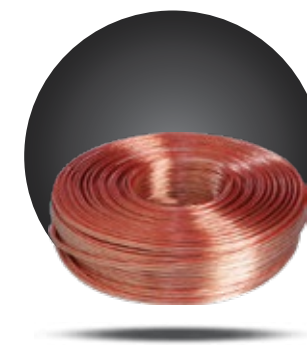

BARCODE	CODE	CABLE CROSS SECTION	WEIGHT	LENGTH	PACKING	PRICE (€)
5206139201508	147-13200	2x0,50mm	1,2kg	100m	100/500	0.15
5206139201515	147-13201	2x0,75mm	1,2kg	100m	100/500	0.19
5206139201522	147-13202	2x1mm	1,8kg	100m	100/500	0.26
5206139201539	147-13203	2X1,5mm	2,3kg	100m	100/500	0.34
5206139201546	147-13204	2X2,5mm	3,8kg	100m	100/500	0.52
5206139201553	147-13205	2X4mm	5,6kg	100m	100/400	0.76

## ALARM CABLES ΚΑΛΩΔΙΑ ΣΥΝΑΓΕΡΜΟΥ

PRODUCTION MATERIAL: **COPPER & PLASTIC**  
ΥΛΙΚΟ ΚΑΤΑΣΚΕΥΗΣ: **ΧΑΛΚΟΣ & ΠΛΑΣΤΙΚΟ**



BARCODE	CODE	CABLE CROSS SECTION	WEIGHT	LENGTH	PACKING	PRICE (€)
5206139200020	147-13102	4x0,22+2x0,50mm	1,6kg	100m	100/800	0.32
5206139200303	147-13130	4x0,22mm	1,4kg	100m	100/1000	0.14
5206139200310	147-13131	8x0,22mm	2,7kg	100m	100/800	0.25
5206139200327	147-13132	6x0,22mm	3,35kg	100m	100/500	0.18

- ALARM CABLES WITH BLANCHED COPPER
- ΚΑΛΩΔΙΑ ΣΥΝΑΓΕΡΜΟΥ ΜΕ ΕΠΙΚΑΣΣΙΤΕΡΩΜΕΝΟ ΧΑΛΚΟ

PRODUCTION MATERIAL: **GALVANIZED IRON & PLASTIC**  
ΥΛΙΚΟ ΚΑΤΑΣΚΕΥΗΣ: **ΓΑΛΒΑΝΙΣΜΕΝΟ ΣΙΔΕΡΟ & ΠΛΑΣΤΙΚΟ**



BARCODE	CODE	CABLE CROSS SECTION	WEIGHT	LENGTH	PACKING	PRICE (€)
5206139200334	147-13133	4x0,22mm	1,92kg	100m	100/500	0.21
5206139200341	147-13134	6x0,22mm	2,64kg	100m	100/500	0.28
5206139200358	147-13135	8x0,22mm	3,36kg	100m	100/500	0.36



**EUROLAMP®**  
Electrical Equipment

- Ατσαλίνες / Στυπιοθλήπτες / Γείωση χαλκού / Θερμοσυστελλόμενα / Κανάλια / Δομημένη Καλωδίωση / Μπουάτ / Εξαρτήματα / Σωλήνες ευθείας & Σπιδράλ
- Steels / Cable glands / Copper ground / Heat shrinkable / Cable trunking / Structured wiring / Boxes / Accessories / Straight tubes & Spiral

Discover our Collection ►



- SEALING WATERPROOF BOX FOR SCHUKO
- ΒΟΧ ΣΤΕΓΑΝΟΠΟΙΗΣΗΣ ΓΙΑ ΣΟΥΚΟ ΦΙΣ



PRODUCTION MATERIAL: **POLYPROPYLENE**  
ΥΛΙΚΟ ΚΑΤΑΣΚΕΥΗΣ: **ΠΟΛΥΠΡΟΠΥΛΕΝΙΟ**



BARCODE	CODE	COLOR	WEIGHT	∅ mm	↔	PACKING	PRICE (€)
520722700058	147-62095	ORANGE	0,13kg	210	70	1/50	2.65

- Περιβλήμα για αδιάβροχη σύνδεση ρεύματος / Housing for waterproof power connection.
- Ιδανικό για εσωτερικούς & εξωτερικούς χώρους / Ideal for indoor and outdoor use.
- Με δύο στυπιοθλήπτες από καουτσούκ για την είσοδο & έξοδο του καλωδίου / Two rubber seals for the cable entry and exit.

- HEAT SHRINKABLE TUBINGS SET
- ΣΕΤ ΘΕΡΜΟΣΥΣΤΕΛΛΟΜΕΝΩΝ ΚΑΛΩΔΙΩΝ

PRODUCTION MATERIAL: **EVA**  
ΥΛΙΚΟ ΚΑΤΑΣΚΕΥΗΣ: **EVA**



BARCODE	CODE	I.D(mm)	THICKNESS	COLOR	PACKING	PRICE (€)
5206139082589	147-11020	2,5	0,25	RED	1/16	8.65
		4,0	0,25	YELLOW		
		6,0	0,35	BLUE		
		8,0	0,35	RED		
		10,0	0,35	GREEN		
		12,0	0,35	BLACK		
		16,0	0,35	BLUE		
		18,0	0,4	WHITE		
		20,0	0,5	BLACK		



- PLASTIC STEELS GERMAN
- ΑΤΣΑΛΙΝΕΣ ΠΛΑΣΤΙΚΕΣ ΓΕΡΜΑΝΙΑΣ

PRODUCTION MATERIAL: **POLYAMIDE**  
ΥΛΙΚΟ ΚΑΤΑΣΚΕΥΗΣ: **ΠΟΛΥΑΜΙΔΙΟ**



BARCODE	CODE	WEIGHT	∅ mm	↔	PACKING	PRICE (€)
5206139005328	147-58000	0,064kg	3	5m	1/10/200	2.96
5206139005373	147-58001	0,103kg	3	10m	1/10/150	3.78
5206139014610	147-58002	0,143kg	3	15m	1/10/120	5.60
5206139018342	147-58003	0,165kg	3	20m	1/10/80	7.60



- COPPER GROUND
- ΓΕΙΩΣΗ ΧΑΛΚΟΥ

PRODUCTION MATERIAL: **METALLIC & COPPER**  
ΥΛΙΚΟ ΚΑΤΑΣΚΕΥΗΣ: **ΜΕΤΑΛΛΙΚΟ & ΧΑΛΚΟΣ**

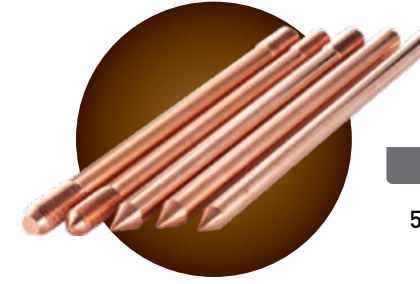
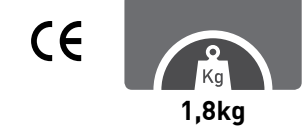

BARCODE	CODE	THICKNESS	∅ mm	↔	PACKING	PRICE (€)
5207227031762	147-08500	0.025mm	16	1.5m	1/10	9.30

- GROUND CABLE CLAMP
- ΣΦΙΓΚΤΗΡΑΣ ΓΕΙΩΣΗΣ

PRODUCTION MATERIAL: **METALLIC & BRASS**  
ΥΛΙΚΟ ΚΑΤΑΣΚΕΥΗΣ: **ΜΕΤΑΛΛΙΚΟ & ΜΠΡΟΥΤΖΙΝΟ**

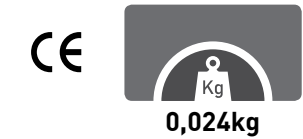

BARCODE	CODE	COLOR	∅ mm	↔	PACKING	PRICE (€)
5207227031779	147-08501	BRASS	16	42m	1/10	1.98

- NYLON CABLE GLANDS
- ΣΤΥΠΙΟΘΛΗΠΤΕΣ

PRODUCTION MATERIAL: **PA66**  
ΥΛΙΚΟ ΚΑΤΑΣΚΕΥΗΣ: **PA66**



BARCODE	CODE	WEIGHT	∅ mm	↔	PACKING	PRICE (€)
5206139204004	147-60000	0,012kg	13,5	37	1/100/2000	0.19
5206139204011	147-60001	0,011kg	16	40	1/100/1500	0.23
5206139204028	147-60002	0,019kg	21	43	1/50/800	0.29
5206139204035	147-60003	0,035kg	29	46	1/50/500	0.69
5206139004932	147-60004	0,062kg	36	58	1/10/300	1.13

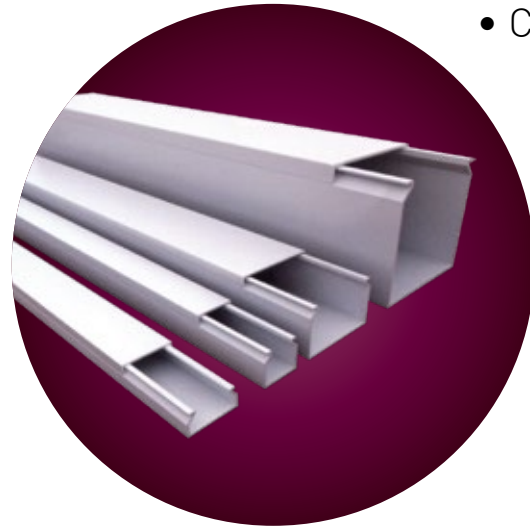

- CABLE TRUNKING CLOSE TYPE CARTON BOX
- ΚΑΝΑΛΙ ΚΛΕΙΣΤΟΥ ΤΥΠΟΥ CARTON BOX

PRODUCTION MATERIAL: **PVC UL 94,VO M1**  
 ΥΛΙΚΟ ΚΑΤΑΣΚΕΥΗΣ: **PVC UL 94,VO M1**



BARCODE	CODE	WEIGHT	↑ mm	↘ mm	↔	PACKING	PRICE (€)
5206139560001	160-56000	0,055kg	12	12	2000	112m	0.35
5206139560018	160-56001	0,060kg	10	15	2000	108m	0.37
5206139560025	160-56002	0,080kg	16	16	2000	72m	0.48
5206139560032	160-56003	0,080kg	10	20	2000	100m	0.48
5206139560049	160-56004	0,125kg	16	25	2000	154m	0.66
5206139560056	160-56005	0,155kg	25	25	2000	96m	0.77
5206139560094	160-56009	0,180kg	16	40	2000	84m	1.02
5206139560100	160-56010	0,200kg	25	40	2000	80m	1.18
5206139560117	160-56011	0,260kg	40	40	2000	72m	1.42
5206139560131	160-56013	0,390kg	40	60	2000	48m	1.93
5206139560148	160-56014	0,475kg	60	60	2000	40m	2.58
5206139560155	160-56015	0,480kg	40	80	2000	36m	2.72
5206139560162	160-56016	0,620kg	60	80	2000	32m	3.26
5206139560179	160-56017	0,630kg	40	100	2000	28m	3.28
5206139560186	160-56018	0,750kg	60	100	2000	24m	4.48

- CABLE TRUNKING CLOSE TYPE NYLON BAG
- ΚΑΝΑΛΙ ΚΛΕΙΣΤΟΥ ΤΥΠΟΥ NYLON BAG

BARCODE	CODE	WEIGHT	↑ mm	↘ mm	↔	PACKING	PRICE (€)
5207227038129	160-56030	0,055kg	12	12	2000	30m	0.38
5207227038143	160-56031	0,060kg	10	15	2000	30m	0.37
5207227038167	160-56032	0,080kg	16	16	2000	30m	0.48
5207227038181	160-56033	0,080kg	10	20	2000	30m	0.48
5207227038204	160-56034	0,125kg	16	25	2000	20m	0.77
5207227038228	160-56035	0,155kg	25	25	2000	20m	1.02
5207227038242	160-56037	0,180kg	16	40	2000	20m	1.02
5207227038266	160-56038	0,200kg	25	40	2000	20m	1.18
5207227038280	160-56039	0,260kg	40	40	2000	20m	1.42
5207227039652	160-56040	0,390kg	40	60	2000	20m	1.93
5207227039676	160-56041	0,475kg	60	60	2000	20m	2.58

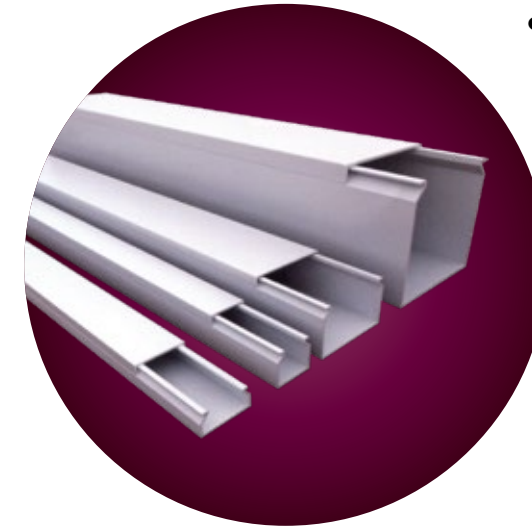

- CABLE TRUNKING ADHESIVE CARTON BOX
- ΚΑΝΑΛΙ ΑΥΤΟΚΟΛΛΗΤΟ CARTON BOX

PRODUCTION MATERIAL: **PVC UL 94,VO M1**  
 ΥΛΙΚΟ ΚΑΤΑΣΚΕΥΗΣ: **PVC UL 94,VO M1**



BARCODE	CODE	WEIGHT	↑ mm	↘ mm	↔	PACKING	PRICE (€)
5206139561008	160-56100	0,058kg	12	12	2000	112m	0.40
5206139561015	160-56101	0,065kg	10	15	2000	108m	0.45
5206139561022	160-56102	0,088kg	16	16	2000	72m	0.56
5206139561039	160-56103	0,082kg	10	20	2000	100m	0.61
5206139561046	160-56104	0,134kg	16	25	2000	154m	0.78
5206139561053	160-56105	0,165kg	25	25	2000	96m	1.06
5206139561091	160-56109	0,195kg	16	40	2000	84m	1.14
5206139561107	160-56110	0,245kg	25	40	2000	80m	1.36
5206139561114	160-56111	0,275kg	40	40	2000	72m	1.53

- CABLE TRUNKING ADHESIVE NYLON BAG
- ΚΑΝΑΛΙ ΑΥΤΟΚΟΛΛΗΤΟ NYLON BAG

PRODUCTION MATERIAL: **PVC UL 94,VO M1**  
 ΥΛΙΚΟ ΚΑΤΑΣΚΕΥΗΣ: **PVC UL 94,VO M1**



BARCODE	CODE	WEIGHT	↑ mm	↘ mm	↔	PACKING	PRICE (€)
5207227038303	160-56130	0,058kg	12	12	2000	30m	0.40
5207227038327	160-56131	0,065kg	10	15	2000	30m	0.45
5207227038341	160-56132	0,088kg	16	16	2000	30m	0.56
5207227038365	160-56133	0,082kg	10	20	2000	30m	0.61
5207227038389	160-56134	0,134kg	16	25	2000	20m	0.78
5207227038402	160-56135	0,165kg	25	25	2000	20m	1.06
5207227038426	160-56137	0,195kg	16	40	2000	20m	1.14
5207227038440	160-56138	0,245kg	25	40	2000	20m	1.36
5207227038464	160-56139	0,275kg	40	40	2000	20m	1.53

- CABLE TRUNKING ADHESIVE CARTON BOX
- ΚΑΝΑΛΙ ΑΥΤΟΚΟΛΛΗΤΟ CARTON BOX

PRODUCTION MATERIAL: **PVC**  
ΥΛΙΚΟ ΚΑΤΑΣΚΕΥΗΣ: **PVC**



### HONEY / ΜΕΛΙ No01



BARCODE	CODE	WEIGHT	↑ mm	↘ mm	↔	PACKING	PRICE (€)
8699430045235	160-56400	0,138kg	12	12	2000	250m	1.08
8699430002504	160-56402	0,185kg	16	16	2000	250m	1.52
8699430002825	160-56404	0,250kg	16	25	2000	140m	2.18

### WALLNUT / ΚΑΡΥΔΙΑ No03



BARCODE	CODE	WEIGHT	↑ mm	↘ mm	↔	PACKING	PRICE (€)
8699430045259	160-56410	0,138kg	12	12	2000	250m	1.08
8699430002528	160-56412	0,185kg	16	16	2000	250m	1.52
8699430002849	160-56414	0,250kg	16	25	2000	140m	2.18

### BEECH / ΟΪΥΑ No04



BARCODE	CODE	WEIGHT	↑ mm	↘ mm	↔	PACKING	PRICE (€)
8699430045266	160-56420	0,138kg	12	12	2000	250m	1.08
8699430002535	160-56422	0,185kg	16	16	2000	250m	1.52
8699430002856	160-56424	0,250kg	16	25	2000	140m	2.18

### SILVER / ΑΣΗΜΙ No01



BARCODE	CODE	WEIGHT	↑ mm	↘ mm	↔	PACKING	PRICE (€)
5207227003974	160-56430	0,185kg	16	16	2000	72m	1.38

- CABLE TRUNKING FLOOR GREY
- ΚΑΝΑΛΙ ΔΑΠΕΔΟΥ ΓΚΡΙ

PRODUCTION MATERIAL: **PVC UL 94, VO M1**  
ΥΛΙΚΟ ΚΑΤΑΣΚΕΥΗΣ: **PVC UL 94, VO M1**

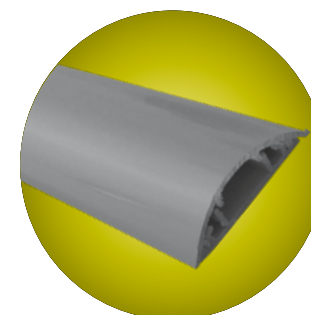

BARCODE	CODE	WEIGHT	↑ mm	↘ mm	↔	PACKING	PRICE (€)
5206139560506	160-56050	0,253kg	12	50	2000	60m	2.58
5206139560513	160-56051	0,465kg	20	70	2000	60m	3.56

- CABLE TRUNKING FLOOR ADHESIVE GREY
- ΚΑΝΑΛΙ ΔΑΠΕΔΟΥ ΑΥΤΟΚΟΛΛΗΤΟ ΓΚΡΙ

BARCODE	CODE	WEIGHT	↑ mm	↘ mm	↔	PACKING	PRICE (€)
5206139561503	160-56150	0,300kg	12	50	2000	60m	3.53
5206139561510	160-56151	0,480kg	20	70	2000	60m	5.18

- CABLE TRUNKING SLOTTED TYPE CARTON BOX
- ΚΑΝΑΛΙ ΔΙΑΤΡΗΤΟ CARTON BOX

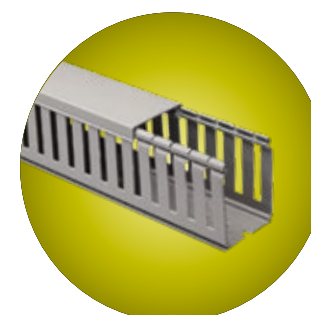

BARCODE	CODE	WEIGHT	↑ mm	↘ mm	↔	PACKING	PRICE (€)
5206139562005	160-56200	0,189kg	25	25	2000	100m	1.88
5206139562029	160-56202	0,331kg	40	40	2000	40m	2.08
5206139562043	160-56204	0,452kg	40	60	2000	30m	2.93
5206139562050	160-56205	0,575kg	60	60	2000	32m	3.43
5206139562067	160-56206	0,556kg	40	80	2000	24m	3.56
5206139562074	160-56207	0,713kg	60	80	2000	24m	4.28

- CABLE TRUNKING STRUCTURED CARTON BOX
- ΚΑΝΑΛΙ ΔΟΜΗΜΕΝΗΣ CARTON BOX

PRODUCTION MATERIAL: **PVC UL 94, VO M1**  
ΥΛΙΚΟ ΚΑΤΑΣΚΕΥΗΣ: **PVC UL 94, VO M1**

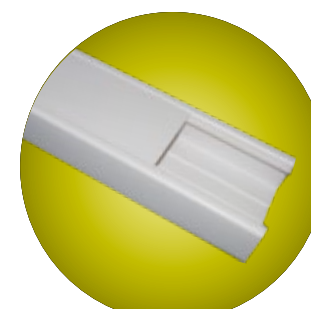

BARCODE	CODE	WEIGHT	↑ mm	↘ mm	↔	PACKING	PRICE (€)
5206139563002	160-56300	1,100kg	50	100	2000	16m	6.38

• PLUG CONNECTOR • ΦΙΣ CONNECTOR

PRODUCTION MATERIAL: **ABS**  
ΥΛΙΚΟ ΚΑΤΑΣΚΕΥΗΣ: **ABS**

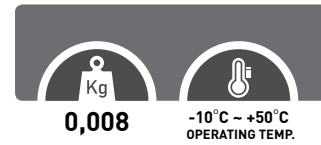
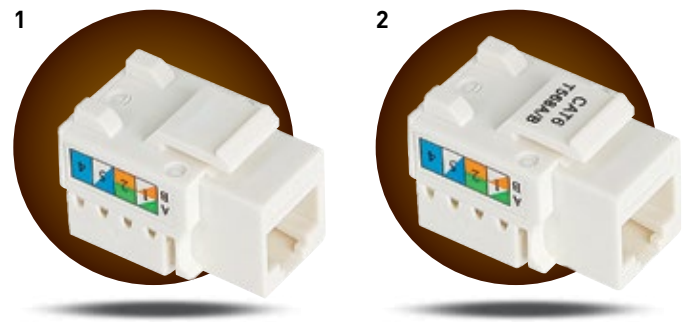

	BARCODE	CODE	DESCRIPTION	mm	mm	mm	PACKING	PRICE (€)
1	5206139800008	160-10000	RG 11 CAT 3	19	17	35	1/100	2.85
2	5206139800015	160-10001	RG 45 CAT 6	18	15	30	1/100	3.20

• SCHUKO SOCKETS • ΠΡΙΖΕΣ ΣΟΥΚΟ

PRODUCTION MATERIAL: **ABS**  
ΥΛΙΚΟ ΚΑΤΑΣΚΕΥΗΣ: **ABS**

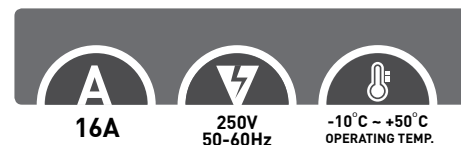
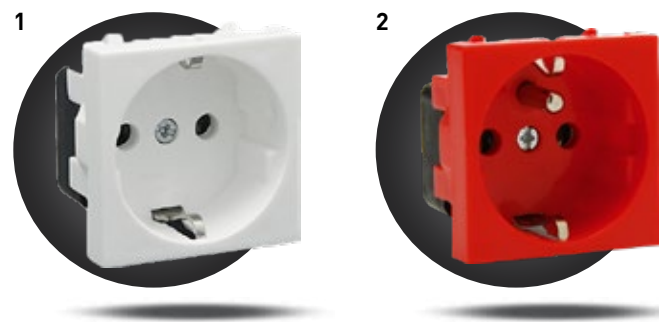

	BARCODE	CODE	DESCRIPTION	WEIGHT	mm	mm	mm	PACKING	PRICE (€)
1	5206139160003	160-16000	16A	0,037kg	33	45	45	1/50	2.90
2	5206139160010	160-16001	UPS 16A	0,040kg	33	45	45	1/50	4.15

• TELEVISION SOCKETS • ΠΡΙΖΕΣ ΤΗΛΕΟΡΑΣΗΣ

PRODUCTION MATERIAL: **PLASTIC & ALUMINIUM**  
ΥΛΙΚΟ ΚΑΤΑΣΚΕΥΗΣ: **ΠΛΑΣΤΙΚΟ & ΑΛΟΥΜΙΝΙΟ**

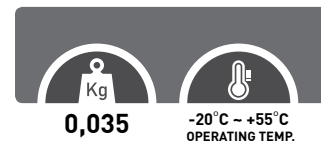
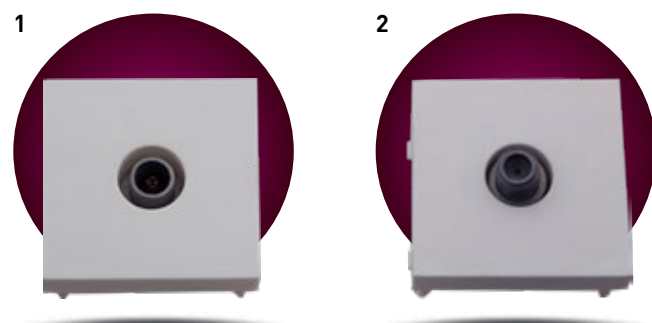

	BARCODE	CODE	DESCRIPTION	mm	mm	mm	PACKING	PRICE (€)
1	5206139160058	160-16005	ΔΙΕΛΕΥΣΕΩΣ / TRANSIT	30	45	45	1/50	10.60
2	5206139160065	160-16006	ΔΙΕΛΕΥΣΕΩΣ / TRANSIT	30	45	45	1/50	10.60

• TELEPHONE KEYS DATA • ΠΛΗΚΤΡΑ ΤΗΛΕΦΩΝΟΥ DATA

PRODUCTION MATERIAL: **ABS**  
ΥΛΙΚΟ ΚΑΤΑΣΚΕΥΗΣ: **ABS**

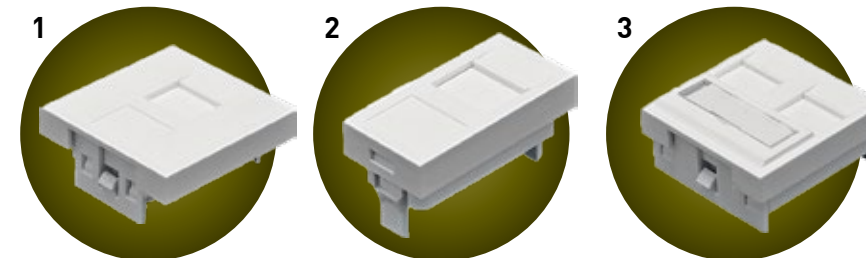

	BARCODE	CODE	DESCRIPTION	PACKING	PRICE (€)
1	5206139160027	160-16002	MONO / SINGLE 45X45	1/100	1.15
2	5206139160034	160-16003	MONO / SINGLE 22,5X45	1/100	1.25
3	5206139160041	160-16004	ΔΙΠΛΟ / DOUBLE 45X45	1/100	1.90

• STRUCTURED ANGLES • ΓΩΝΙΕΣ ΔΟΜΗΜΕΝΗΣ

PRODUCTION MATERIAL: **PVC UL 94, V0 M1**  
ΥΛΙΚΟ ΚΑΤΑΣΚΕΥΗΣ: **PVC UL 94, V0 M1**

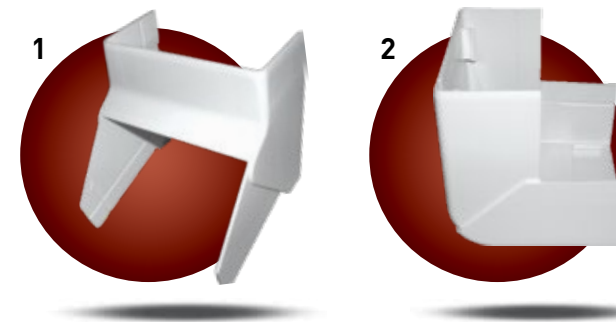

	BARCODE	CODE	DESCRIPTION	WEIGHT	PACKING	PRICE (€)
1	5206139563101	160-56310	ΕΣΩΤΕΡΙΚΗ / INNER	0,060kg	1/12	1.85
2	5206139563118	160-56311	ΕΞΩΤΕΡΙΚΗ / EXTERNAL	0,075kg	1/12	1.85

• T STRUCTURED • ΤΑΦ ΔΟΜΗΜΕΝΗΣ

PRODUCTION MATERIAL: **PVC UL 94, V0 M1**  
ΥΛΙΚΟ ΚΑΤΑΣΚΕΥΗΣ: **PVC UL 94, V0 M1**

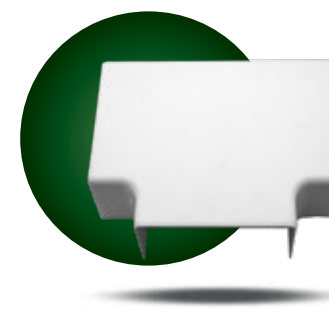

	BARCODE	CODE	COLOR	WEIGHT	PACKING	PRICE (€)
	5206139563125	160-56312	WHITE	0,069kg	1/10	2.85

• ANGLE 90° STRUCTURED • ΓΩΝΙΑ 90° ΔΟΜΗΜΕΝΗΣ



PRODUCTION MATERIAL: **PVC UL 94, V0 M1**  
ΥΛΙΚΟ ΚΑΤΑΣΚΕΥΗΣ: **PVC UL 94, V0 M1**



BARCODE	CODE	COLOR	WEIGHT	PACKING	PRICE (€)
5206139563132	160-56313	WHITE	0,060kg	1/12	1.85

• CAP STRUCTURED • ΤΑΠΑ ΔΟΜΗΜΕΝΗΣ

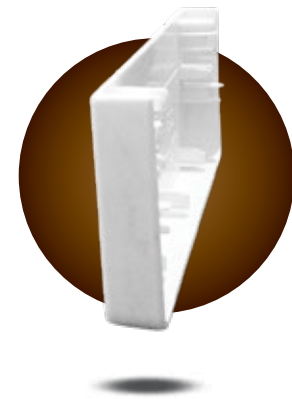

PRODUCTION MATERIAL: **PVC UL 94, V0 M1**  
ΥΛΙΚΟ ΚΑΤΑΣΚΕΥΗΣ: **PVC UL 94, V0 M1**



BARCODE	CODE	COLOR	WEIGHT	PACKING	PRICE (€)
5206139563149	160-56314	WHITE	0,009kg	1/24	0.66

• JUNCTION FOR COVER • ΕΝΩΤΙΚΟ ΓΙΑ ΚΑΠΑΚΙ



PRODUCTION MATERIAL: **PVC UL 94, V0 M1**  
ΥΛΙΚΟ ΚΑΤΑΣΚΕΥΗΣ: **PVC UL 94, V0 M1**



BARCODE	CODE	COLOR	WEIGHT	PACKING	PRICE (€)
5206139563156	160-56315	WHITE	0,009kg	1/24	0.82

• SEPERATOR FOR CABLE TRUNKING • ΔΙΑΧΩΡΙΣΤΙΚΟ ΓΙΑ ΚΑΝΑΛΙ



PRODUCTION MATERIAL: **PVC UL 94, V0 M1**  
ΥΛΙΚΟ ΚΑΤΑΣΚΕΥΗΣ: **PVC UL 94, V0 M1**



BARCODE	CODE	COLOR	WEIGHT	PACKING	PRICE (€)
5206139563163	160-56316	WHITE	0,055kg	100m	1.60

• ASSEMBLY SET FOR STRUCTURED • ΠΛΑΙΣΙΑ ΔΟΜΗΜΕΝΗΣ

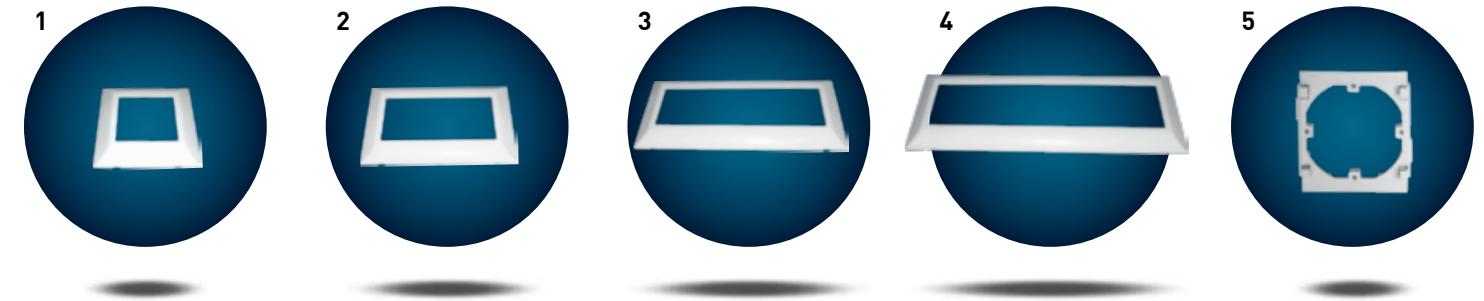

PRODUCTION MATERIAL: **PVC UL 94, V0 M1**  
ΥΛΙΚΟ ΚΑΤΑΣΚΕΥΗΣ: **PVC UL 94, V0 M1**



	BARCODE	CODE	DESCRIPTION	WEIGHT	PACKING	PRICE (€)
1	5206139563200	160-56320	ΜΟΝΟ / SINGLE	0,018kg	1/12	1.06
2	5206139563217	160-56321	ΔΙΠΛΟ / DOUBLE	0,025kg	1/12	1.42
3	5206139563224	160-56322	ΤΡΙΠΛΟ / TRIPLE	0,041kg	1/12	1.86
4	5206139563231	160-56323	ΤΕΤΡΑΠΛΟ / QUADRUPLE	0,056kg	1/20	2.26
5	5206139563248	160-56324	ΜΟΝΟ ΔΙΑΦΟΡΩΝ ΔΙΑΚΟΠΤΩΝ SINGLE FOR DIFFERENT KINDS OF SWITCHES	0,018kg	1/24	0.98

• PLASTERBOARD BOXES • ΚΥΤΙΑ ΓΥΦΟΣΑΝΙΔΑΣ

PRODUCTION MATERIAL: **POLYPROPYLENE**  
ΥΛΙΚΟ ΚΑΤΑΣΚΕΥΗΣ: **ΠΟΛΥΠΡΟΠΥΛΕΝΙΟ**



	BARCODE	CODE	DESCRIPTION	WEIGHT	PACKING	PRICE (€)
1	5206139006967	151-21032	ΜΟΝΟ / SINGLE	0,028kg	1/100	0.58
2	5206139068422	151-21035	ΔΙΠΛΟ / DOUBLE	0,044kg	1/100	0.92
3	5206139068439	151-21036	ΤΡΙΠΛΟ / TRIPLE	0,064kg	1/100	1.48

• SHEATHING SCREW ANCHOR • ΟΥΠΑ ΓΥΦΟΣΑΝΙΔΑΣ



PRODUCTION MATERIAL: **PLASTIC**  
ΥΛΙΚΟ ΚΑΤΑΣΚΕΥΗΣ: **ΠΛΑΣΤΙΚΟ**



CODE	COLOR	PACKING	PRICE (€)
151-08000	SILVER	1/100	4.85



• TOP WITH EARS • ΚΑΠΑΚΙ ΜΕ ΑΥΤΙΑ

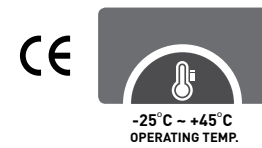

BARCODE	CODE	DESCRIPTION	PACKING	PRICE (€)
5206139630209	151-21020	Φ80mm	1/250	0.19
5206139630216	151-21021	SUPER Φ110mm	1/150	0.29

• SWITCH BOXES & CONNECTORS • ΚΥΤΙΑ ΔΙΑΚΟΠΤΟΥ & ΣΥΝΔΕΣΜΟΙ

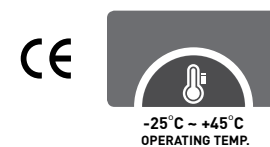
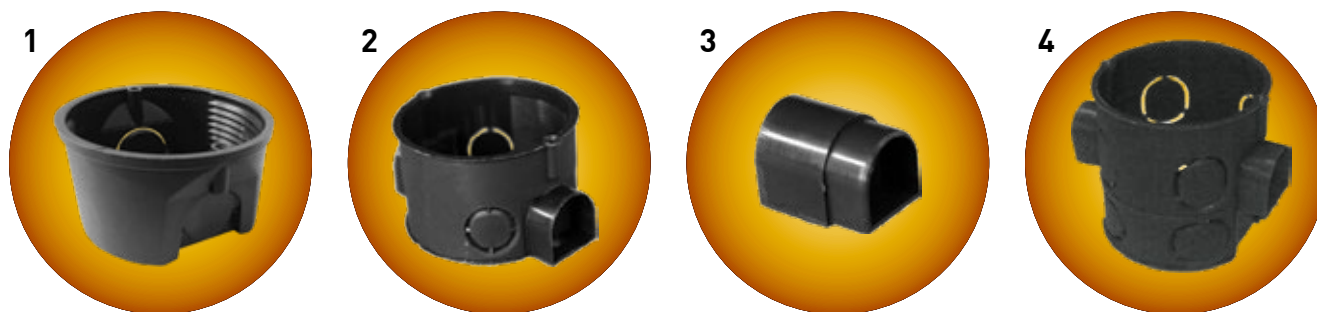

	BARCODE	CODE	DESCRIPTION	PACKING	PRICE (€)
1	5206139630001	151-21000	ΚΟΥΤΙ ΔΙΑΚΟΠΤΟΥ / SWITCH BOX	1/100	0.14
2	5206139068149	151-21003	ΚΟΥΤΙ ΣΥΝΔΕΟΜΕΝΟ / SWITCH BOX CONNECTED	1/100	0.23
3	5206139068163	151-21004	ΣΥΝΔΕΣΜΟΣ ΚΥΤΙΟΥ / CONJUNCTION BOX	1/100	0.08
4	5207227029318	151-21008	ΚΟΥΤΙ ΔΙΑΚΟΠΤΟΥ ΒΑΘΥ / DEEP SWITCH BOX	1/100	0.40

• JUNCTION BOXES ROUND • ΚΟΥΤΙΑ ΔΙΑΚΛΑΔΩΣΗΣ ΣΤΡΟΓΓΥΛΑ

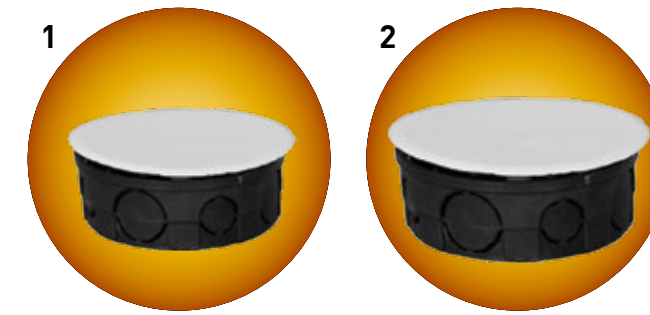

COLOR: **BLACK**  
ΧΡΩΜΑ: **ΜΑΥΡΟ**

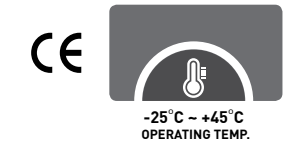

	BARCODE	CODE	Ø mm	↑	PACKING	PRICE (€)
1	5206139630018	151-21001	70	35	1/100	0.21
2	5206139630025	151-21002	100	35	1/150	0.42

• JUNCTION BOXES SQUARE • ΚΟΥΤΙΑ ΔΙΑΚΛΑΔΩΣΗΣ ΤΕΤΡΑΓΩΝΑ

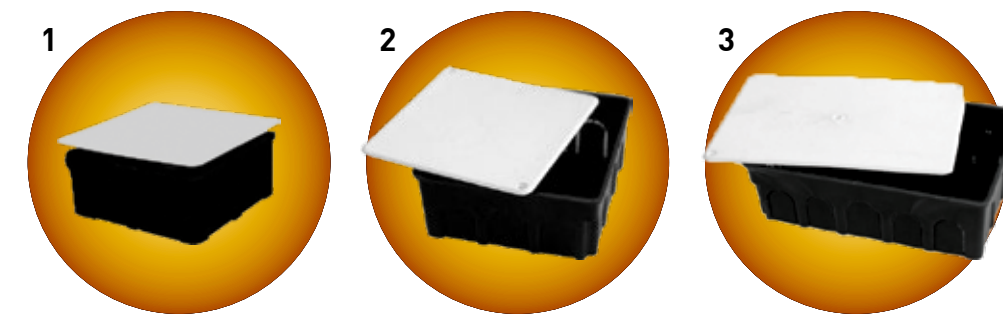

COLOR: **BLACK**  
ΧΡΩΜΑ: **ΜΑΥΡΟ**

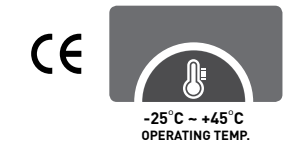

	BARCODE	CODE	DIMENSIONS (mm)	PACKING	PRICE (€)
1	5206139068170	151-21005	75x75	1/50	0.52
2	5206139068187	151-21006	100x100	1/30	0.65
3	5206139068194	151-21007	100x150	1/20	1.09

• LIGHT BOXES • ΚΟΥΤΙΑ ΦΩΤΙΣΤΙΚΩΝ

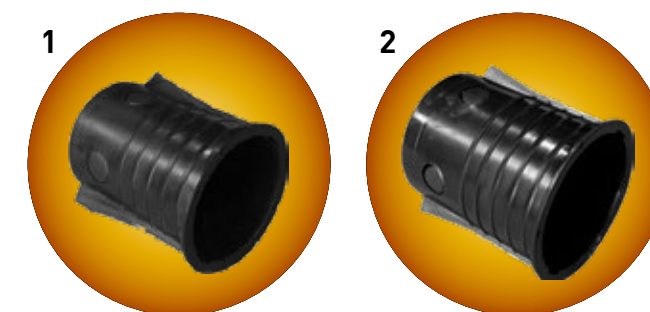

COLOR: **BLACK**  
ΧΡΩΜΑ: **ΜΑΥΡΟ**

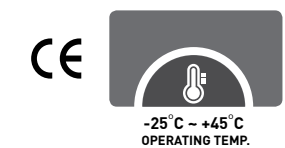

	BARCODE	CODE	DESCRIPTION	PACKING	PRICE (€)
1	5203730061401	151-21030	R50	1/30	0.66
2	5203730061500	151-21031	R80-R63	1/20	0.69

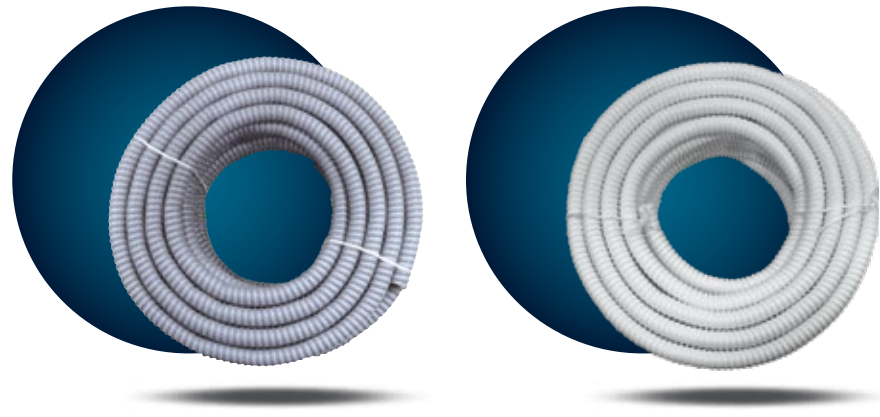

- SPIRAL CONDUITS
- ΣΩΛΗΝΕΣ ΧΕΛΙΦΛΕΞ

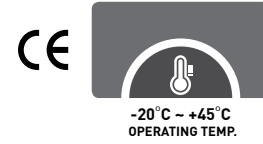

BARCODE	CODE	COLOR	∅ mm	←→	PACKING	PRICE (€)
5206139638007	151-21800	GRAY	10	25m	25m	0.61
5206139638014	151-21801	GRAY	12	25m	25m	0.58
5206139638021	151-21802	GRAY	14	25m	25m	0.62
5206139638038	151-21803	GRAY	16	25m	25m	0.64
5206139638045	151-21804	GRAY	18	25m	25m	0.76
5206139638052	151-21805	GRAY	20	25m	25m	0.79
5206139638069	151-21806	GRAY	22	25m	25m	0.94
5206139638076	151-21807	GRAY	25	25m	25m	1.08
5206139638083	151-21808	GRAY	28	25m	25m	1.38
5206139638106	151-21810	GRAY	32	25m	25m	1.54
5207227033131	151-21812	GRAY	38	25m	25m	2.02
5207227033148	151-21813	GRAY	40	25m	25m	2.42
5206139009098	151-21815	WHITE	16	25m	25m	0.64
5206139009104	151-21816	WHITE	18	25m	25m	0.76
5207227033155	151-21817	WHITE	20	25m	25m	0.79

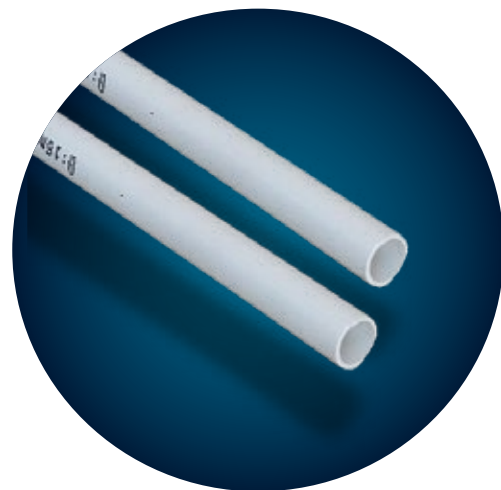

- STRAIGHT TUBES MEDIUM TYPE
- ΣΩΛΗΝΕΣ ΕΥΘΕΙΑΣ ΜΕΣΑΙΟΥ ΤΥΠΟΥ

PRODUCTION MATERIAL: **PVC**  
ΥΛΙΚΟ ΚΑΤΑΣΚΕΥΗΣ: **PVC**



BARCODE	CODE	COLOR	∅ mm	←→	PACKING	PRICE (€)
5206139633002	151-21300	GRAY	16	3m	90m	0.42
5206139633019	151-21301	GRAY	20	3m	90m	0.63
5206139633026	151-21302	GRAY	25	3m	90m	0.92
5206139633033	151-21303	GRAY	32	3m	90m	1.09

- SUPPORTS FOR TUBES MEDIUM TYPE
- ΣΤΗΡΙΓΜΑΤΑ ΓΙΑ ΣΩΛΗΝΕΣ ΜΕΣΑΙΟΥ ΤΥΠΟΥ

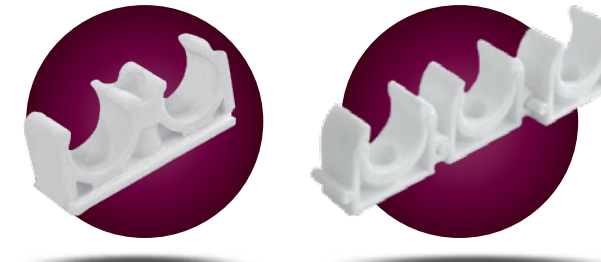

PRODUCTION MATERIAL: **PVC**  
ΥΛΙΚΟ ΚΑΤΑΣΚΕΥΗΣ: **PVC**



BARCODE	CODE	DIAMETER	WEIGHT	PACKING	PRICE (€)
5206139008862	151-21400	16mm	0,008kg	1/100	0.08
5206139008879	151-21401	20mm	0,010kg	1/100	0.09
5206139008886	151-21402	25mm	0,013kg	1/50	0.11
5207227075261	151-21403	32mm	0,015kg	1/50	0.17

- CORNERS FOR TUBES MEDIUM TYPE
- ΓΩΝΙΕΣ ΓΙΑ ΣΩΛΗΝΕΣ ΜΕΣΑΙΟΥ ΤΥΠΟΥ



PRODUCTION MATERIAL: **PVC**  
ΥΛΙΚΟ ΚΑΤΑΣΚΕΥΗΣ: **PVC**



BARCODE	CODE	DIAMETER	COLOR	PACKING	PRICE (€)
5206139008893	151-21410	16mm	GREY	1/50	0.26
5206139008923	151-21411	20mm	GREY	1/50	0.38
5206139008961	151-21412	25mm	GREY	1/50	0.52
5207227075278	151-21413	32mm	GREY	1/20	0.66

- COUPLERS FOR TUBES MEDIUM TYPE
- ΜΟΥΦΕΣ ΓΙΑ ΣΩΛΗΝΕΣ ΜΕΣΑΙΟΥ ΤΥΠΟΥ



PRODUCTION MATERIAL: **PVC**  
ΥΛΙΚΟ ΚΑΤΑΣΚΕΥΗΣ: **PVC**



BARCODE	CODE	DIAMETER	WEIGHT	PACKING	PRICE (€)
5206139008978	151-21420	16mm	0,010kg	1/20	0.18
5206139008985	151-21421	20mm	0,012kg	1/20	0.28
5206139008992	151-21422	25mm	0,014kg	1/50	0.31
5207227075285	151-21423	32mm	0,016kg	1/20	0.36

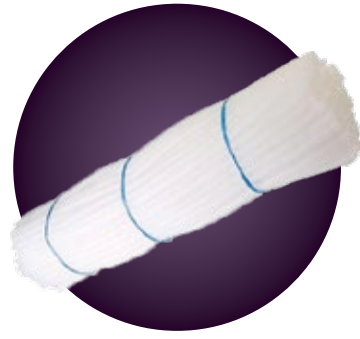

- STRAIGHT TUBE LIGHT TYPE
- ΣΩΛΗΝΕΣ ΕΥΘΕΙΑΣ ΕΛΑΦΡΟΥ ΤΥΠΟΥ

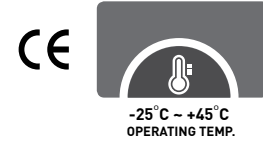

BARCODE	CODE	COLOR	∅ mm	← →	PACKING	PRICE (€)
5206139632005	151-21200	WHITE	11	3m	102m	0.33
5206139632012	151-21201	WHITE	13,5	3m	102m	0.42
5206139632029	151-21202	WHITE	16	3m	60m	0.49
5206139632036	151-21203	WHITE	23	3m	60m	0.82



- SPIRAL TUBE LIGHT TYPE
- ΣΩΛΗΝΕΣ ΣΠΙΡΑΛ ΕΛΑΦΡΟΥ ΤΥΠΟΥ

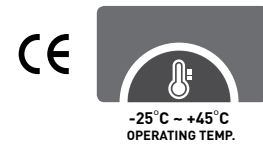

BARCODE	CODE	COLOR	∅ mm	← →	PACKING	PRICE (€)
5206139620002	151-51000	WHITE	11	50m	50m	0.19
5206139620101	151-51010	WHITE	13,5	50m	50m	0.23
5206139620200	151-51020	WHITE	16	50m	50m	0.29
5206139620309	151-51030	WHITE	23	50m	50m	0.49



- CONCRETE TUBES
- ΣΩΛΗΝΕΣ ΜΠΕΤΟΥ

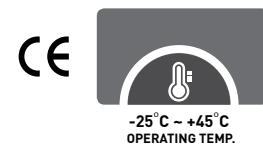

BARCODE	CODE	COLOR	∅ mm	← →	PACKING	PRICE (€)
5206139621009	151-51100	GRAY	13,5	50m	50m	0.56
5206139621016	151-51101	GRAY	16	50m	50m	0.60
5206139621023	151-51102	GRAY	23	50m	50m	0.85
5206139621092	151-51109	GRAY	11	50m	50m	0.29

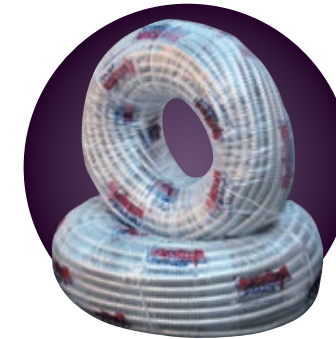

- METAL SPIRAL
- ΜΕΤΑΛΛΙΚΑ ΣΠΙΡΑΛ



BARCODE	CODE	DESCRIPTION	DIAMETER	COLOR	PACKING	PRICE (€)
5206139006011	151-21500	No9	9mm	IRON	50m	0.43
5206139006028	151-21501	No11	11mm	IRON	50m	0.52
5206139006035	151-21502	No14	14mm	IRON	50m	0.58
5206139006042	151-21503	No16	16mm	IRON	50m	0.63
5206139006110	151-21504	No18	18mm	IRON	50m	0.78
5206139006127	151-21505	No21	21mm	IRON	50m	1.18
5206139006134	151-21506	No26	26mm	IRON	30m	1.32



• FLAT CABLES WHITE • ΚΑΛΩΔΙΑ ΠΛΑΚΕ ΛΕΥΚΑ NYIFY-R

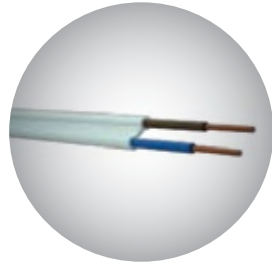

BARCODE	CODE	DIMENSION (mm <sup>2</sup> )	WEIGHT	PACKING
5206139055132	150-13000	2x1,5	0,082kg/1m	100m/Roll
5206139055149	150-13001	3x1,5	0,123kg/1m	100m/Roll
5206139055156	150-13002	3x2,5	0,156kg/1m	100m/Roll
5207227075537	150-13004	4x1,5	0,135kg/1m	100m/Roll

• CABLES WHITE WITH RED LINE • ΚΑΛΩΔΙΑ ΛΕΥΚΑ ΜΕ ΚΟΚΚΙΝΗ ΓΡΑΜΜΗ NYFAZ H03VH-H



BARCODE	CODE	DIMENSION (mm <sup>2</sup> )	WEIGHT	PACKING
5207227020278	150-13050	2x0,50	0,022kg/1m	100m/Roll
5207227020261	150-13051	2x0,75	0,028kg/1m	100m/Roll

• FLEXIBLE CABLES BLACK • ΕΥΚΑΜΠΤΑ ΚΑΛΩΔΙΑ ΜΑΥΡΑ H03VV-F / H05VV-F\*

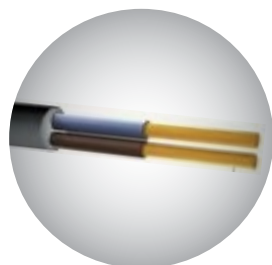

BARCODE	CODE	DIMENSION (mm <sup>2</sup> )	WEIGHT	PACKING
5207227074769	150-13150	2x0,50	0,037kg/1m	100m/Roll
5207227074776	150-13151	2x0,75	0,048kg/1m	100m/Roll
5207227032653	150-13152	* 2x1	0,066kg/1m	100m/Roll
5207227032660	150-13153	* 2x1,5	0,085kg/1m	100m/Roll
5206139004345	150-13157	* 3x1	0,079kg/1m	100m/Roll
5207227029301	150-13158	* 3x1,5	0,108kg/1m	100m/Roll
5206139004352	150-13159	* 3x2,5	0,167kg/1m	100m/Roll

• FLEXIBLE CABLES WHITE • ΕΥΚΑΜΠΤΑ ΚΑΛΩΔΙΑ ΛΕΥΚΑ H03VV-F / H05VV-F\*

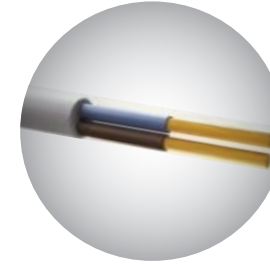

BARCODE	CODE	DIMENSION (mm <sup>2</sup> )	WEIGHT	PACKING
5206139055095	150-13100	2x0,50	0,037kg/1m	100m/Roll
5206139055118	150-13101	2x0,75	0,048kg/1m	100m/Roll
5206139043528	150-13102	* 2x1	0,066kg/1m	100m/Roll
5206139045591	150-13103	* 2x1,5	0,085kg/1m	100m/Roll
5206139043535	150-13106	3x0,75	0,058kg/1m	100m/Roll
5206139043542	150-13107	* 3x1	0,079kg/1m	100m/Roll
5206139043566	150-13108	* 3x1,5	0,108kg/1m	100m/Roll
5206139045607	150-13109	* 3x2,5	0,167kg/1m	100m/Roll
5206139043573	150-13110	* 3x4	0,230kg/1m	100m/Roll
5206139045614	150-13111	* * 3x6	0,297kg/1m	100m/Roll
5206139043580	150-13113	* 4x0,75	0,086kg/1m	100m/Roll
5206139043597	150-13114	* 4x1	0,101kg/1m	100m/Roll
5206139043603	150-13115	* 4x1,5	0,136kg/1m	100m/Roll
5206139043627	150-13116	* 4x2,5	0,206kg/1m	100m/Roll
5206139043634	150-13122	* 5x1,5	0,169kg/1m	100m/Roll
5206139043641	150-13123	* 5x2,5	0,256kg/1m	100m/Roll
5206139055125	150-13124	* 5x4	0,360kg/1m	100m/Roll
5207227020889	150-13125	* * 5x6	0,504kg/1m	100m/Roll
5207227074745	150-13127	* 7x1,5	0,205kg/1m	100m/Roll
5207227074752	150-13128	* 7x2,5	0,312kg/1m	100m/Roll

• CABLES NYA • ΚΑΛΩΔΙΑ NYA H07V-U 1x1,5mm<sup>2</sup>



BARCODE	CODE	COLOR	WEIGHT	PACKING
5206139055170	150-13310	BLACK	0,020kg/1m	100m/Roll
5206139055187	150-13311	BLUE	0,020kg/1m	100m/Roll
5206139055194	150-13312	GREEN / YELLOW	0,020kg/1m	100m/Roll
5206139055200	150-13313	BROWN	0,020kg/1m	100m/Roll
5206139055217	150-13314	RED	0,020kg/1m	100m/Roll
5206139088925	150-13315	WHITE	0,020kg/1m	100m/Roll

• CABLES • ΚΑΛΩΔΙΑ  
NYA H07V-U 1x2,5mm<sup>2</sup>



BARCODE	CODE	COLOR	WEIGHT	PACKING
5206139055231	150-13320	BLACK	0,032kg/1m	100m/Roll
5206139055248	150-13321	BLUE	0,032kg/1m	100m/Roll
5206139055255	150-13322	GREEN / YELLOW	0,032kg/1m	100m/Roll
5207227020896	150-13323	BROWN	0,032kg/1m	100m/Roll
5207227020902	150-13324	RED	0,032kg/1m	100m/Roll

• CABLES • ΚΑΛΩΔΙΑ  
NYA H07V-U 1x4mm<sup>2</sup>

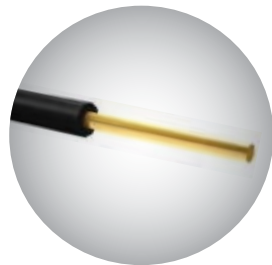

BARCODE	CODE	COLOR	WEIGHT	PACKING
5207227020919	150-13330	BLACK	0,046kg/1m	100m/Roll
5207227020926	150-13331	BLUE	0,046kg/1m	100m/Roll
5207227020933	150-13332	GREEN / YELLOW	0,046kg/1m	100m/Roll
5207227074721	150-13333	BROWN	0,046kg/1m	100m/Roll
5207227074738	150-13334	RED	0,046kg/1m	100m/Roll

• CABLES • ΚΑΛΩΔΙΑ  
NYA H07V-R 1x6mm<sup>2</sup>

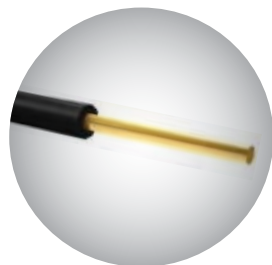

BARCODE	CODE	COLOR	WEIGHT	PACKING
5207227020292	150-13340	BLACK	0,066kg/1m	100m/Roll
5207227020285	150-13341	BLUE	0,066kg/1m	100m/Roll
5206139088895	150-13342	GREEN / YELLOW	0,066kg/1m	100m/Roll
5207227059131	150-13343	BROWN	0,066kg/1m	100m/Roll
5207227059148	150-13344	RED	0,066kg/1m	100m/Roll

• CABLES • ΚΑΛΩΔΙΑ  
NYA H07V-R 1x10mm<sup>2</sup>

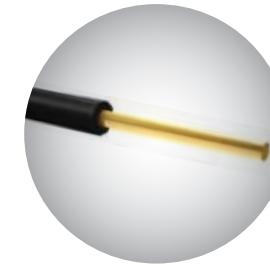

BARCODE	CODE	COLOR	WEIGHT	PACKING
5206139088963	150-13350	BLACK	0,110kg/1m	100m/Roll
5206139088932	150-13351	BLUE	0,110kg/1m	100m/Roll
5207227020308	150-13352	GREEN / YELLOW	0,110kg/1m	100m/Roll
5207227020940	150-13353	BROWN	0,110kg/1m	100m/Roll
5207227020957	150-13354	RED	0,110kg/1m	100m/Roll

• CABLES • ΚΑΛΩΔΙΑ  
NYA H07V-R 1x16mm<sup>2</sup>

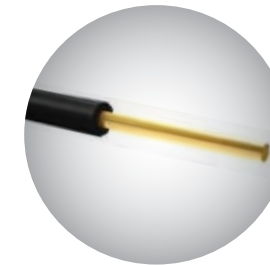

BARCODE	CODE	COLOR	WEIGHT	PACKING
5207227058622	150-13360	BLACK	0,165kg/1m	100m/Roll
5207227074783	150-13361	BLUE	0,165kg/1m	100m/Roll
5207227074790	150-13362	GREEN / YELLOW	0,165kg/1m	100m/Roll

• CABLES WHITE • ΚΑΛΩΔΙΑ ΛΕΥΚΑ  
NYM H05VV-U / H05VV-R\*

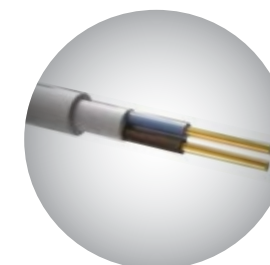

BARCODE	CODE	DIMENSION (mm <sup>2</sup> )	WEIGHT	PACKING
5206139055262	150-13600	2x1,5	0,124kg/1m	100m/Roll
5206139616029	150-13602	3x1,5	0,134kg/1m	100m/Roll
5206139045621	150-13603	3x2,5	0,186kg/1m	100m/Roll
5206139057648	150-13604	3x4	0,258kg/1m	100m/Roll
5206139088949	150-13605 *	3x6	0,328kg/1m	100m/Roll
5206139045638	150-13609	4x1,5	0,161kg/1m	100m/Roll
5206139055279	150-13610	4x2,5	0,226kg/1m	100m/Roll
5207227074806	150-13611 *	4x4	0,312kg/1m	100m/Roll
5206139616159	150-13615	5x1,5	0,193kg/1m	100m/Roll
5206139616166	150-13616	5x2,5	0,273kg/1m	100m/Roll
5206139055293	150-13617 *	5x4	0,416kg/1m	1000m/Drum
5206139088956	150-13618 *	5x6	0,538kg/1m	1000m/Drum

• COPPER GROUND CU • ΧΑΛΚΟΣ ΓΕΙΩΣΗΣ CU

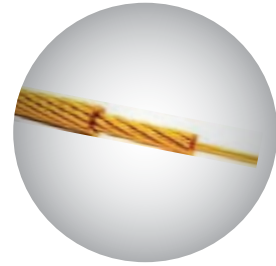

BARCODE	CODE	DIMENSION (mm <sup>2</sup> )	1kg= X m
5206139089106	150-13651	16mm <sup>2</sup>	1kg=7,3m
5206139089120	150-13652	25mm <sup>2</sup>	1kg=4,6m
5206139089137	150-13653	35mm <sup>2</sup>	1kg=3,4m
5206139082596	150-13654	50mm <sup>2</sup>	1kg=2,4m
5207227055898	150-13655	70mm <sup>2</sup>	1kg=1,7m
5206139082602	150-13656	95mm <sup>2</sup>	1kg=1,25m

• SOLAR CABLES • ΚΑΛΩΔΙΑ SOLAR H1Z2Z2-K



BARCODE	CODE	DIMENSION (mm <sup>2</sup> )	COLOR	PACKING
5207227066399	150-12002	6mm <sup>2</sup>	RED	100m/Roll
5207227066405	150-12003	6mm <sup>2</sup>	RED - BLACK	100m/Roll

• DATA CABLES PET • ΚΑΛΩΔΙΑ ΑΣΘΕΝΗ PET UTP - FTP

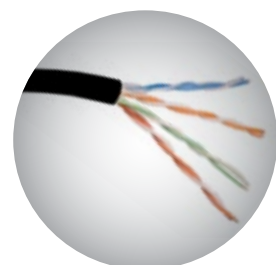

BARCODE	CODE	DESCRIPTION	WEIGHT	PACKING
5207227054907	150-14000	CAT-5e FTP	0,031kg/1m	500m/Drum
5207227054914	150-14001	CAT-5e UTP	0,029kg/1m	1000m/Drum
5207227054921	150-14002	CAT-6e FTP	0,039kg/1m	500m/Drum
5207227054938	150-14003	CAT-6e UTP	0,033kg/1m	1000m/Drum
5207227066382	150-14010	CAT-5e SFTP	0,038kg/1m	1000m/Drum

• CABLES BLACK • ΚΑΛΩΔΙΑ ΜΑΥΡΑ NYY J1W-U / J1W-R\*

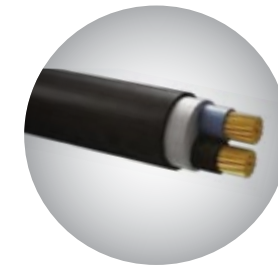

BARCODE	CODE	DIMENSION (mm <sup>2</sup> )	WEIGHT	PACKING
5206139055309	150-13700	2x1,5	0,148kg/1m	100m/Roll
5206139054197	150-13702	3x1,5	0,171kg/1m	100m/Roll
5206139617033	150-13703	3x2,5	0,214kg/1m	100m/Roll
5206139054203	150-13704	3x4	0,312kg/1m	100m/Roll
5206139088987	150-13705 *	3x6	0,393kg/1m	100m/Roll
5207227029851	150-13706 *	3x10	0,586kg/1m	1000m/Drum
5206139088994	150-13707 *	3x10+1,5	0,632kg/1m	1000m/Drum
5207227039621	150-13708 *	3x16	0,804kg/1m	1000m/Drum
5206139089007	150-13709 *	3x16+1,5	0,804kg/1m	1000m/Drum
5207227055225	150-13710 *	3x25	1,177kg/1m	1000m/Drum
5207227058646	150-13715 *	3x50+25	2,444kg/1m	1000m/Drum
5206139054210	150-13725	4x1,5	0,204kg/1m	100m/Roll
5206139089021	150-13726	4x2,5	0,267kg/1m	100m/Roll
5207227074813	150-13727	4x4	0,380kg/1m	100m/Roll
5207227029868	150-13728 *	4x6	0,482kg/1m	100m/Roll
5207227028496	150-13729 *	4x10	0,730kg/1m	1000m/Drum
5207227074820	150-13730 *	4x16	1,008kg/1m	1000m/Drum
5206139054227	150-13734	5x1,5	0,250kg/1m	100m/Roll
5206139054234	150-13735	5x2,5	0,319kg/1m	100m/Roll
5206139089045	150-13736	5x4	0,453kg/1m	1000m/Drum
5206139089052	150-13737 *	5x6	0,629kg/1m	1000m/Drum
5207227029875	150-13738 *	5x10	0,885kg/1m	1000m/Drum
5206139089069	150-13739 *	5x10+1,5	0,936kg/1m	1000m/Drum
5207227029882	150-13740 *	5x16	1,247kg/1m	1000m/Drum
5206139089076	150-13741 *	5x16+1,5	1,288kg/1m	1000m/Drum
5207227058202	150-13742 *	5x25	1,820kg/1m	1000m/Drum
5206139089083	150-13743 *	5x25+2,5	1,960kg/1m	1000m/Drum

• IRON CABLE • ΚΑΛΩΔΙΟ ΣΙΔΗΡΟΥ

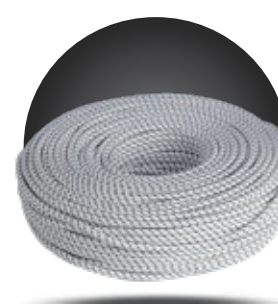

BARCODE	CODE	DIMENSION (mm <sup>2</sup> )	WEIGHT	PACKING	PRICE (€)
5206139201805	147-13250	3x0,75	3,500kg/100m	100/400m	1.46

# EUROLAMP®

Pioneers in New Technology !

Νέα Σειρά Φωτο-Βολταϊκών Panels / New Photovoltaic Panels Series



Μono-κρυσταλλικές & Πολυ-κρυσταλλικές Κυψέλες,  
με εξαιρετική ποιότητα κατασκευής και ιδανικούς δείκτες απόδοσης ισχύος !

Mono-crystalline & Multi-crystalline Blisters,  
with excellent build quality and ideal power efficiency indicators!

manufactured and supported by

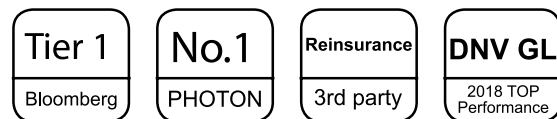

**10-year** Warranty for Material & Processing  
**25-year** Warranty for Extra Linear Power Output  
(1<sup>st</sup> year ≤ 3%, 2<sup>nd</sup>~25<sup>th</sup> years ≤ 0.7% / year)



# CHINT

INVERTER για χρήση σε Δίκτυο και σε Οικίες

INVERTER for Network and Home use



ΚΩΔΙΚΟΙ ΗΛΙΑΚΩΝ ΠΑΝΕΛ				
EUROLAMP CODE	SOLAR PANEL TYPE	RANGE WATTAGE	EFFICIENT WATTAGE	MODEL
200-80000 *	MONOCRYSTALLINE PV MODULE	290W-310W	310W	CHSM6610M
200-80001 *	MONOCRYSTALLINE PV MODULE	320W-340W	335W	CHSM60M-HC
200-80002 *	POLYCRYSTALLINE PV MODULE	275W-290W	280W	CHSM6610P0

ΚΩΔΙΚΟΙ INVERTER		
EUROLAMP CODE	INVERTER TYPE	ΧΡΗΣΗ / USAGE
200-80003	CPS ECH 3.6K-GB	ΣΤΕΓΗ ΣΠΙΤΙΩΝ / HOUSE ROOF
200-80004	CPS SCA1-3.6KTL-S/EU	ΦΩΤΟΒΟΛΤΑΪΚΑ ΠΑΡΚΑ / PHOTOVOLTAIC PARKS

\* Άμεση διαθεσιμότητα λόγω επαρκούς αποθέματος σε Logistic Center στην Γερμανία  
Για περισσότερες πληροφορίες, παρακαλούμε επικοινωνήστε με τα κεντρικά γραφεία της EUROLAMP

\* Available at once, due to sufficient stock at Logistic Center in Germany  
For more information, please contact EUROLAMP Head Office

ΠΙΣΤΟΠΟΙΗΜΕΝΗ ΠΟΙΟΤΗΤΑ





## • ΠΡΟΩΘΗΤΙΚΟ STAND ΠΡΟΪΟΝΤΩΝ ΗΛΕΚΤΡΟΛΟΓΙΚΟΥ ΥΛΙΚΟΥ

Η **EUROLAMP**, σας διαθέτει **ΔΩΡΕΑΝ** αυτό το Προωθητικό Σταντ Προϊόντων, κομψό και λειτουργικό, κατάλληλο για κάθε επαγγελματικό χώρο.

Η διάθεση του προϋποθέτει **ελάχιστη ποσότητα παραγγελίας** προϊόντων, τα οποία εμφανίζονται στον διπλανό πίνακα.

Για περισσότερες πληροφορίες παρακαλούμε απευθυνθείτε στον πωλητή που σας εξυπηρετεί.

## • PROMOTIONAL STAND ELECTRICAL EQUIPMENT PRODUCTS

**EUROLAMP** is able to provide you for FREE this Promotional Product Stand, smart and practical, suitable for all business facilities.

For order placing requirements, please check minimum quantities which appear in the table on the right.

For more information please contact our associate sales representative.

### 147-99805

- STAND ΠΡΟΪΟΝΤΩΝ ΗΛΕΚΤΡΟΛΟΓΙΚΟΥ ΥΛΙΚΟΥ
- ELECTRICAL EQUIPMENT PRODUCTS STAND

### ΕΛΑΧΙΣΤΗ ΑΠΑΙΤΟΥΜΕΝΗ ΠΑΡΑΓΓΕΛΙΑ ΓΙΑ ΤΗΝ ΔΩΡΕΑΝ ΔΙΑΘΕΣΗ ΤΟΥ ΣΤΑΝΤ

ΚΩΔΙΚΟΣ	ΠΕΡΙΓΡΑΦΗ	ΤΕΜ.
147-09013	ΑΝΤΑΠΤΟΡΑΣ ΣΟΥΚΟ ΜΕ 2 USB ΜΠΛΕ, ΜΕ ΠΡΟΣΤΑΣΙΑ ΥΠΕΡΤΑΣΗΣ & ΠΑΙΔΙΚΗ ΠΡΟΣΤΑΣΙΑ	5
147-10002	ΣΟΥΚΟ 3 ΕΞΟΔΩΝ (ΣΤΑΥΡΟΣ) ΚΑΘΕΤΟ ΜΕ ΠΑΙΔΙΚΗ ΠΡΟΣΤΑΣΙΑ	10
147-10004	ΤΑΦ ΣΟΥΚΟ ΜΕ ΠΑΙΔΙΚΗ ΠΡΟΣΤΑΣΙΑ	10
147-10019	ΣΟΥΚΟ 3 ΕΞΟΔΩΝ (ΣΤΑΥΡΟΣ) ΟΡΙΖΟΝΤΙΟ ΜΕ ΔΙΑΚΟΠΤΗ & ΠΑΙΔΙΚΗ ΠΡΟΣΤΑΣΙΑ	10
147-10020	ΣΟΥΚΟ 3 ΕΞΟΔΩΝ (ΣΤΑΥΡΟΣ) ΟΡΙΖΟΝΤΙΟ ΜΕ ΠΑΙΔΙΚΗ ΠΡΟΣΤΑΣΙΑ	10
147-10025	ΦΙΣ ΣΟΥΚΟ ΑΡΣΕΝΙΚΟ SLIM ΠΛΑΓΕΙΑΣ ΛΕΥΚΟ 16A 220-240V	10
147-10029	ΑΝΤΑΠΤΟΡΑΣ ΣΟΥΚΟ ΜΕ ΠΡΟΣΤΑΣΙΑ ΥΠΕΡΤΑΣΗΣ & ΠΑΙΔΙΚΗ ΠΡΟΣΤΑΣΙΑ ΣΕ ΣΥΣΚΕΥΑΣΙΑ BLISTER	5
147-13016	ΠΡΟΕΚΤΑΣΗ ΓΕΡΜΑΝΙΚΩΝ ΠΡΟΔΙΑΓΡΑΦΩΝ 3m 3X1.5mm ΜΕ ΠΑΙΔΙΚΗ ΠΡΟΣΤΑΣΙΑ	10
147-13017	ΠΡΟΕΚΤΑΣΗ ΓΕΡΜΑΝΙΚΩΝ ΠΡΟΔΙΑΓΡΑΦΩΝ 5m 3X1.5mm ΜΕ ΠΑΙΔΙΚΗ ΠΡΟΣΤΑΣΙΑ	10
147-13019	ΠΡΟΕΚΤΑΣΗ ΓΕΡΜΑΝΙΚΩΝ ΠΡΟΔΙΑΓΡΑΦΩΝ 10m 3X1.5mm ΜΕ ΠΑΙΔΙΚΗ ΠΡΟΣΤΑΣΙΑ	5
147-13025	ΠΡΟΕΚΤΑΣΗ ΠΛΑΚΕ ΓΕΡΜΑΝΙΚΩΝ ΠΡΟΔΙΑΓΡΑΦΩΝ 3m 2X0.75mm ΜΕ ΠΑΙΔΙΚΗ ΠΡΟΣΤΑΣΙΑ	5
147-13026	ΠΡΟΕΚΤΑΣΗ ΠΛΑΚΕ ΓΕΡΜΑΝΙΚΩΝ ΠΡΟΔΙΑΓΡΑΦΩΝ 5m 2X0.75mm ΜΕ ΠΑΙΔΙΚΗ ΠΡΟΣΤΑΣΙΑ	5
147-62107	ΠΟΛΥΠΡΙΖΟ ΥΠΕΡΤΑΣΗΣ 5 ΘΕΣΕΩΝ ΜΕ ΚΑΛΩΔΙΟ ΚΑΙ ΔΙΑΚΟΠΤΗ 1,5m, 3X1,5mm, ΜΕ ΠΑΙΔΙΚΗ ΠΡΟΣΤΑΣΙΑ	5
147-62150	ΠΟΛΥΠΡΙΖΟ 3 ΘΕΣΕΩΝ 3500W, 2 USB 2.1A, ΚΑΛΩΔΙΟ 3X1,5mm 1,5m ΜΕ ΠΑΙΔΙΚΗ ΠΡΟΣΤΑΣΙΑ	5
147-62201	ΠΟΛΥΠΡΙΖΟ 3 ΘΕΣΕΩΝ ΜΕ ΚΑΛΩΔΙΟ 3X1,5mm 1,5m ΜΕ ΠΑΙΔΙΚΗ ΠΡΟΣΤΑΣΙΑ	10
147-62202	ΠΟΛΥΠΡΙΖΟ 4 ΘΕΣΕΩΝ ΜΕ ΚΑΛΩΔΙΟ 3X1,5mm 1,5m ΜΕ ΠΑΙΔΙΚΗ ΠΡΟΣΤΑΣΙΑ	10
147-62203	ΠΟΛΥΠΡΙΖΟ 5 ΘΕΣΕΩΝ ΜΕ ΚΑΛΩΔΙΟ 3X1,5mm 1,5m ΜΕ ΠΑΙΔΙΚΗ ΠΡΟΣΤΑΣΙΑ	10
147-62211	ΠΟΛΥΠΡΙΖΟ 3 ΘΕΣΕΩΝ ΜΕ ΚΑΛΩΔΙΟ ΚΑΙ ΔΙΑΚΟΠΤΗ 3X1,5mm 1,5m ΜΕ ΠΑΙΔΙΚΗ ΠΡΟΣΤΑΣΙΑ	10
147-62212	ΠΟΛΥΠΡΙΖΟ 4 ΘΕΣΕΩΝ ΜΕ ΚΑΛΩΔΙΟ ΚΑΙ ΔΙΑΚΟΠΤΗ 3X1,5mm 1,5m ΜΕ ΠΑΙΔΙΚΗ ΠΡΟΣΤΑΣΙΑ	10
147-62213	ΠΟΛΥΠΡΙΖΟ 5 ΘΕΣΕΩΝ ΜΕ ΚΑΛΩΔΙΟ ΚΑΙ ΔΙΑΚΟΠΤΗ 3X1,5mm 1,5m ΜΕ ΠΑΙΔΙΚΗ ΠΡΟΣΤΑΣΙΑ	10
800-10023	ΦΙΣ ΔΙΠΟΛΙΚΟ ΑΡΣΕΝΙΚΟ ΣΕ BLISTER	10
800-10024	ΦΙΣ ΔΙΠΟΛΙΚΟ ΘΗΛΥΚΟ ΜΕ ΠΑΙΔΙΚΗ ΠΡΟΣΤΑΣΙΑ ΣΕ BLISTER ΣΥΣΚΕΥΑΣΙΑ	10
800-10038	ΦΙΣ ΣΟΥΚΟ ΑΡΣΕΝΙΚΟ ΣΕ BLISTER	10
800-10039	ΦΙΣ ΣΟΥΚΟ ΘΗΛΥΚΟ ΜΕ ΠΑΙΔΙΚΗ ΠΡΟΣΤΑΣΙΑ ΣΕ BLISTER ΣΥΣΚΕΥΑΣΙΑ	10

### MINIMUM ORDER REQUIRED FOR FREE STAND DISPOSAL

CODE	DESCRIPTION	PCS
147-09013	ADAPTOR SCHUKO WITH 2 USB BLUE, WITH SURGE PROTECTION & CHILDREN PROTECTION	5
147-10002	ADAPTOR SCHUKO TO 3 SCHUKO CROSS VERTICAL WITH CHILDREN PROTECTION	10
147-10004	ADAPTOR SCHUKO TO 2 SCHUKO WITH CHILDREN PROTECTION	10
147-10019	ADAPTOR SCHUKO TO 3 SCHUKO CROSS HORIZONTAL WITH SWITCH & CHILDREN PROTECTION	10
147-10020	ADAPTOR SCHUKO TO 3 SCHUKO CROSS HORIZONTAL WITH CHILDREN PROTECTION	10
147-10025	PLUG SCHUKO MALE SLIM RIGHT ANGLE WHITE 16A 220-240V	10
147-10029	ADAPTOR SCHUKO WITH SURGE PROTECTION & CHILDREN PROTECTION IN BLISTER PACKAGING	5
147-13016	EXTENSION CORD GERMAN TYPE 3m 3X1.5mm WITH CHILDREN PROTECTION	10
147-13017	EXTENSION CORD GERMAN TYPE 5m 3X1.5mm WITH CHILDREN PROTECTION	10
147-13019	EXTENSION CORD GERMAN TYPE 10m 3X1.5mm WITH CHILDREN PROTECTION	5
147-13025	EXTENSION CORD FLAT GERMAN TYPE 3m 2X0.75mm WITH CHILDREN PROTECTION	5
147-13026	EXTENSION CORD FLAT GERMAN TYPE 5m 2X0.75mm WITH CHILDREN PROTECTION	5
147-62107	SOCKET SURGE PROTECTOR 5 HOLES WITH CABLE & SWITCH 3X1,5mm EXTENSION 1,5m, WITH CHILDREN PROTECTION	5
147-62150	SOCKET 3 SCHUKO HOLES 3500W, 2 USB 2.1A, CABLE 3X1,5mm EXTENSION 1,5m WITH CHILDREN PROTECTION	5
147-62201	SOCKET 3 SCHUKO HOLES CABLE 3X1,5mm EXTENSION 1,5m WITH CHILDREN PROTECTION	10
147-62202	SOCKET 4 SCHUKO HOLES CABLE 3X1,5mm EXTENSION 1,5m WITH CHILDREN PROTECTION	10
147-62203	SOCKET 5 SCHUKO HOLES CABLE 3X1,5mm EXTENSION 1,5m WITH CHILDREN PROTECTION	10
147-62211	SOCKET 3 SCHUKO HOLES CABLE 3X1,5mm EXTENSION 1,5m WITH SWITCH & CHILDREN PROTECTION	10
147-62212	SOCKET 4 SCHUKO HOLES CABLE 3X1,5mm EXTENSION 1,5m WITH SWITCH & CHILDREN PROTECTION	10
147-62213	SOCKET 5 SCHUKO HOLES CABLE 3X1,5mm EXTENSION 1,5m WITH SWITCH & CHILDREN PROTECTION	10
800-10023	PLUG 2 POLE NORMAL MALE 2.5A 240V BLISTER	10
800-10024	PLUG 2 POLE NORMAL FEMALE 6A 240V WITH CHILDREN PROTECTION IN BLISTER PACKING	10
800-10038	PLUG SCHUKO MALE 16A 240V BLISTER	10
800-10039	PLUG SCHUKO FEMALE 16A 240V WITH CHILDREN PROTECTION IN BLISTER PACKING	10

# EUROLAMP®

Pioneers in New Technology !

- ΠΡΟΩΘΗΤΙΚΑ STANDS
- PROMOTIONAL STANDS



## • ΠΡΟΩΘΗΤΙΚΟ STAND ΛΑΜΠΤΗΡΩΝ LED FILAMENT & LED SMD

Η **EUROLAMP**, σας διαθέτει **ΔΩΡΕΑΝ** αυτό το Προωθητικό Σταντ Προϊόντων, κομψό και λειτουργικό, κατάλληλο για κάθε επαγγελματικό χώρο.

Η διάθεση του προϋποθέτει **ελάχιστη ποσότητα παραγγελίας** προϊόντων, τα οποία εμφανίζονται στον διπλανό πίνακα.

Για περισσότερες πληροφορίες παρακαλούμε απευθυνθείτε στον πωλητή που σας εξυπηρετεί.

## • PROMOTIONAL STAND LED FILAMENT BULBS & LED SMD BULBS

**EUROLAMP** is able to provide you for FREE this Promotional Product Stand, smart and practical, suitable for all business facilities.

For order placing requirements, please check minimum quantities which appear in the table on the right.

For more information please contact our associate sales representative.

**147-99804**

- STAND ΛΑΜΠΤΗΡΩΝ LED FILAMENT & LED SMD
- BULBS PRODUCTS STAND / LED FILAMNE & LED SMD

# LED SMD

- ΕΛΑΧΙΣΤΗ ΑΠΑΙΤΟΥΜΕΝΗ ΠΑΡΑΓΓΕΛΙΑ ΓΙΑ ΤΗΝ ΔΩΡΕΑΝ ΔΙΑΘΕΣΗ ΤΟΥ ΣΤΑΝΤ
- MINIMUM ORDER REQUIRED FOR FREE STAND DISPOSAL

CODE	ΠΕΡΙΓΡΑΦΗ	DESCRIPTION	PCS
147-80222	ΛΑΜΠΑ LED MINION 5W E14 6500K 220-240V	LED LAMP CANDLE 5W E14 6500K 220-240V	50
147-80223	ΛΑΜΠΑ LED MINION 5W E14 2700K 220-240V	LED LAMP CANDLE 5W E14 2700K 220-240V	30
147-80224	ΛΑΜΠΑ LED MINION 7W E14 6500K 220-240V	LED LAMP CANDLE 7W E14 6500K 220-240V	50
147-80226	ΛΑΜΠΑ LED MINION 7W E14 2700K 220-240V	LED LAMP CANDLE 7W E14 2700K 220-240V	30
147-80230	ΛΑΜΠΑ LED ΣΦΑΙΡΙΚΗ 5W E14 6500K 220-240V	BULB LED GLOBE G45 5W E14 6500K 220-240V	20
147-80231	ΛΑΜΠΑ LED ΣΦΑΙΡΙΚΗ 5W E14 2700K 220-240V	BULB LED GLOBE G45 5W E14 2700K 220-240V	20
147-80234	ΛΑΜΠΑ LED ΣΦΑΙΡΙΚΗ 7W E14 6500K 220-240V	BULB LED GLOBE G45 7W E14 6500K 220-240V	20
147-80236	ΛΑΜΠΑ LED ΣΦΑΙΡΙΚΗ 7W E14 2700K 220-240V	BULB LED GLOBE G45 7W E14 2700K 220-240V	20
147-80201	ΛΑΜΠΑ LED ΚΟΙΝΗ 8W E27 6500K 220-240V	BULB LED A60 8W E27 6500K 220-240V	50
147-80203	ΛΑΜΠΑ LED ΚΟΙΝΗ 12W E27 6500K 220-240V	BULB LED A60 12W E27 6500K 220-240V	50
147-80204	ΛΑΜΠΑ LED ΚΟΙΝΗ 15W E27 6500K 220-240V	BULB LED A60 15W E27 6500K 220-240V	30
147-80211	ΛΑΜΠΑ LED ΚΟΙΝΗ 8W E27 2700K 220-240V	BULB LED A60 8W E27 2700K 220-240V	50
147-80213	ΛΑΜΠΑ LED ΚΟΙΝΗ 12W E27 2700K 220-240V	BULB LED A60 12W E27 2700K 220-240V	50
147-80214	ΛΑΜΠΑ LED ΚΟΙΝΗ 15W E27 2700K 220-240V	BULB LED A60 15W E27 2700K 220-240V	30
147-84490	ΛΑΜΠΑ LED SMD ΓΛΟΜΠΟΣ Φ95 12W E27 6500K 220-240V	BULB LED SMD GLOBE G95 12W E27 6500K 220-240V	10
147-84491	ΛΑΜΠΑ LED SMD ΓΛΟΜΠΟΣ Φ95 12W E27 2700K 220-240V	BULB LED SMD GLOBE G95 12W E27 2700K 220-240V	10

• Για το συγκεκριμένο STAND μπορείτε να επιλέξετε τη ομάδα λαμπτήρων **LED SMD** από τον πίνακα επάνω, ή την ομάδα λαμπτήρων **LED CROSS FILAMENT** από τον πίνακα κάτω.

• For this STAND you can select the group of **LED SMD** lamps from the table above, or the group of **LED CROSS FILAMENT** lamps from the table below.

# LED CROSS Filament

- ΕΛΑΧΙΣΤΗ ΑΠΑΙΤΟΥΜΕΝΗ ΠΑΡΑΓΓΕΛΙΑ ΓΙΑ ΤΗΝ ΔΩΡΕΑΝ ΔΙΑΘΕΣΗ ΤΟΥ ΣΤΑΝΤ
- MINIMUM ORDER REQUIRED FOR FREE STAND DISPOSAL

CODE	ΠΕΡΙΓΡΑΦΗ / DESCRIPTION	PCS
147-78111	LED LAMP C37 CROSSED FILAMENT 4.5W E14 4000K 220-240V	25
147-78121	LED LAMP C37 CROSSED FILAMENT 4.5W E14 3000K 220-240V	25
147-78114	LED LAMP C37 CROSSED FILAMENT 4.5W E14 4000K 220-240V FROST	25
147-78124	LED LAMP C37 CROSSED FILAMENT 4.5W E14 3000K 220-240V FROST	25
147-78251	LED LAMP G45 CROSSED FILAMENT 4.5W E27 4000K 220-240V	25
147-78261	LED LAMP G45 CROSSED FILAMENT 4.5W E27 3000K 220-240V	25
147-78224	LED LAMP G45 CROSSED FILAMENT 4.5W E14 3000K 220-240V FROST	25
147-78264	LED LAMP G45 CROSSED FILAMENT 4.5W E27 3000K 220-240V FROST	25
147-78012	LED LAMP A60 CROSSED FILAMENT 7W E27 4000K 220-240V CLEAR	20
147-78032	LED LAMP CROSSED FILAMENT A60 7W E27 3000K 220-240V CLEAR	20
147-78013	LED LAMP A60 CROSSED FILAMENT 9W E27 4000K 220-240V CLEAR	20
147-78033	LED LAMP CROSSED FILAMENT A60 9W E27 3000K 220-240V CLEAR	20
147-78015	LED LAMP A67 CROSSED FILAMENT 11W E27 4000K 220-240V CLEAR	20
147-78035	LED LAMP A67 CROSSED FILAMENT 11W E27 3000K 220-240V CLEAR	20
147-78412	LED LAMP GLOBE G95 CROSSED FILAMENT 11W E27 4000K 220-240V MILKY	20
147-78442	LED LAMP GLOBE G120 CROSSED FILAMENT 11W E27 4000K 220-240V MILKY	20

- ΠΡΟΩΘΗΤΙΚΑ STANDS • PROMOTIONAL STANDS



- ΠΡΟΩΘΗΤΙΚΟ STAND  
ΑΛΚΑΛΙΚΩΝ  
ΜΠΑΤΑΡΙΩΝ

Η **EUROLAMP**, σας διαθέτει **ΔΩΡΕΑΝ** αυτό το Προωθητικό Σταντ Προϊόντων, κομψό και λειτουργικό, κατάλληλο για κάθε επαγγελματικό χώρο.

Η διάθεση του προϋποθέτει **ελάχιστη ποσότητα παραγγελίας** προϊόντων, τα οποία εμφανίζονται στον διπλανό πίνακα.

Για περισσότερες πληροφορίες παρακαλούμε απευθυνθείτε στον πωλητή που σας εξυπηρετεί.

- PROMOTIONAL STAND  
ALKALINE  
BATTERIES

**EUROLAMP** is able to provide you for FREE this Promotional Product Stand, smart and practical, suitable for all business facilities.

For order placing requirements, please check minimum quantities which appear in the table on the right.

For more information please contact our associate sales representative.

**147-99806**

- ΣΤΑΝΤ ΑΛΚΑΛΙΚΩΝ ΜΠΑΤΑΡΙΩΝ
- ALKALINE BATTERIES STAND

Super  
Power



#### ΕΛΑΧΙΣΤΗ ΑΠΑΙΤΟΥΜΕΝΗ ΠΑΡΑΓΓΕΛΙΑ ΓΙΑ ΤΗΝ ΔΩΡΕΑΝ ΔΙΑΘΕΣΗ ΤΟΥ ΣΤΑΝΤ

CODE	DESCRIPTION	PCS
147-24100	ΜΠΑΤΑΡΙΑ ΑΛΚΑΛΙΚΗ 1.5 V AAA LR03	60
147-24101	ΜΠΑΤΑΡΙΑ ΑΛΚΑΛΙΚΗ 1.5 V AA LR6	60
147-24102	ΜΠΑΤΑΡΙΑ ΑΛΚΑΛΙΚΗ 1.5 V C LR14	24
147-24103	ΜΠΑΤΑΡΙΑ ΑΛΚΑΛΙΚΗ 1.5 V D LR20	24
147-24104	ΜΠΑΤΑΡΙΑ ΑΛΚΑΛΙΚΗ 9V 6LR61	24
147-24152	ΜΠΑΤΑΡΙΑ ΑΛΚΑΛΙΚΗ 1.5 V AAA LR03 (4+1)	36
147-24153	ΜΠΑΤΑΡΙΑ ΑΛΚΑΛΙΚΗ 1.5 V AA LR6 (4+1)	36
147-24162	ΜΠΑΤΑΡΙΑ ΑΛΚΑΛΙΚΗ 24 ΤΕΜ 1,5 V AAA LR03	10
147-24163	ΜΠΑΤΑΡΙΑ ΑΛΚΑΛΙΚΗ 24 ΤΕΜ 1,5 V AA LR6	10
147-24110	ΜΠΑΤΑΡΙΑ ΛΙΘΙΟΥ CR2032 3V 5 τεμ	12
147-24111	ΜΠΑΤΑΡΙΑ ΛΙΘΙΟΥ CR2025 3V 5 τεμ	12
147-24112	ΜΠΑΤΑΡΙΑ ΑΛΚΑΛΙΚΗ A76 LR44 1.5V 5pcs	12
147-24105	ΜΠΑΤΑΡΙΑ ΑΛΚΑΛΙΚΗ 12V 23A 5pcs	5

#### MINIMUM ORDER REQUIRED FOR FREE STAND DISPOSAL

CODE	DESCRIPTION	PCS
147-24100	ALKALINE BATTERIES 1.5 V AAA LR03	60
147-24101	ALKALINE BATTERIES 1.5 V AA LR6	60
147-24102	ALKALINE BATTERIES 1.5 V C LR14	24
147-24103	ALKALINE BATTERIES 1.5 V D LR20	24
147-24104	ALKALINE BATTERIES 9V 6LR61	24
147-24152	ALKALINE BATTERIES 1.5 V AAA LR03 (4+1)	36
147-24153	ALKALINE BATTERIES 1.5 V AA LR6 (4+1)	36
147-24162	ALKALINE BATTERIES 24PCS 1,5 V AAA LR03	10
147-24163	ALKALINE BATTERIES 24PCS 1,5 V AA LR6	10
147-24110	BATTERIES CR2032 3V blister 5pcs	12
147-24111	BATTERIES CR2025 3V blister 5pcs	12
147-24112	ALKALINE BATTERIES A76 LR44 1.5V 5pcs blister	12
147-24105	ALKALINE BATTERIES 12V 23A 5pcs	5

# EUROLAMP®

Pioneers in New Technology !

- ΠΡΟΩΘΗΤΙΚΑ STANDS • PROMOTIONAL STANDS



147-99807

- ΣΤΑΝΤ ΚΑΛΑΘΙ ΔΙΑΦΟΡΩΝ ΠΡΟΪΟΝΤΩΝ
- SEVERAL PRODUCTS BASKET STAND

204

## • ΠΡΟΩΘΗΤΙΚΟ STAND ΔΙΑΦΟΡΩΝ ΠΡΟΪΟΝΤΩΝ

Η **EUROLAMP**, σας διαθέτει **ΔΩΡΕΑΝ** αυτό το Προωθητικό Σταντ Προϊόντων, κομψό και λειτουργικό, κατάλληλο για κάθε επαγγελματικό χώρο.

Η διάθεση του προϋποθέτει **ελάχιστη ποσότητα παραγγελίας** προϊόντων, τα οποία εμφανίζονται στον παρακάτω πίνακα.

Για περισσότερες πληροφορίες παρακαλούμε απευθυνθείτε στον πωλητή που σας εξυπηρετεί.

## • PROMOTIONAL STAND SEVERAL PRODUCTS

**EUROLAMP** is able to provide you for FREE this Promotional Product Stand, smart and practical, suitable for all business facilities.

For order placing requirements, please check minimum quantities which appear in the table below.

For more information please contact our associate sales representative.

Το καλάθι δίνεται **ΔΩΡΟ** με όποια επιλογή κωδικών ροής γίνει από τον πελάτη.

Απαραίτητη προϋπόθεση αποτελεί το σύνολο της παραγγελίας να έχει **ελάχιστη καθαρή αξία: 250€**

The basket is FREE given any combination in flow codes (ή products) selected by the customer.

Necessary condition:  
**Total minimum net worth (ή value) of order: 250€**

205





Ζητήστε να σας αποσταλλεί ο Νέος Κατάλογος της **MAGIC CHRISTMAS**.  
Πλήρης γκάμα κωδικών για κάθε κατηγορία ειδών Χριστουγεννιάτικου Διάκοσμου  
Βρείτε τον και σε Ψηφιακή μορφή στο:  
[www.eurolamp.gr](http://www.eurolamp.gr)

Ask for the new **MAGIC CHRISTMAS** Catalog to be sent to you.  
Complete range of codes for each category of Christmas decorations.  
Find it also in Digital form at:  
[www.eurolampglobal.com](http://www.eurolampglobal.com)

Handwriting practice area consisting of multiple horizontal dotted lines.

# EUROLAMP®

Pioneers in New Technology !

EUROLAMP A.B.E.E.  
Κάμπος ΔΙΑΒΑΤΩΝ / ΙΩΝΙΑ  
Τ.Θ. 515 / 570 08  
ΘΕΣΣΑΛΟΝΙΚΗ  
T: 2310 574802  
F: 2310 574919  
info@eurolamp.gr

[www.eurolamp.gr](http://www.eurolamp.gr)

EUROLAMP SA  
Kampos Diavata / IONIA  
P.O. 515 / 570 08  
THESSALONIKI - GREECE  
T: +30 2310 574802  
F: +30 2310 574919  
info@eurolamp.gr

[www.eurolampglobal.com](http://www.eurolampglobal.com)

EUROLAMP BELGIUM SPRL  
829, B2 Chausse de Marche  
5100 Wierde  
Belgique  
Wallonie T: +320479172657  
Flandres T: +320493444162  
email: info@eurolamp.be

[www.eurolamp.be](http://www.eurolamp.be)



 <https://www.facebook.com/eurolampSA/>

 [https://www.instagram.com/eurolamp\\_sa/](https://www.instagram.com/eurolamp_sa/)