



CATALOGUE /2017

 KUNDALINI



CATALOGUE /2017

 **KUNDALINI**

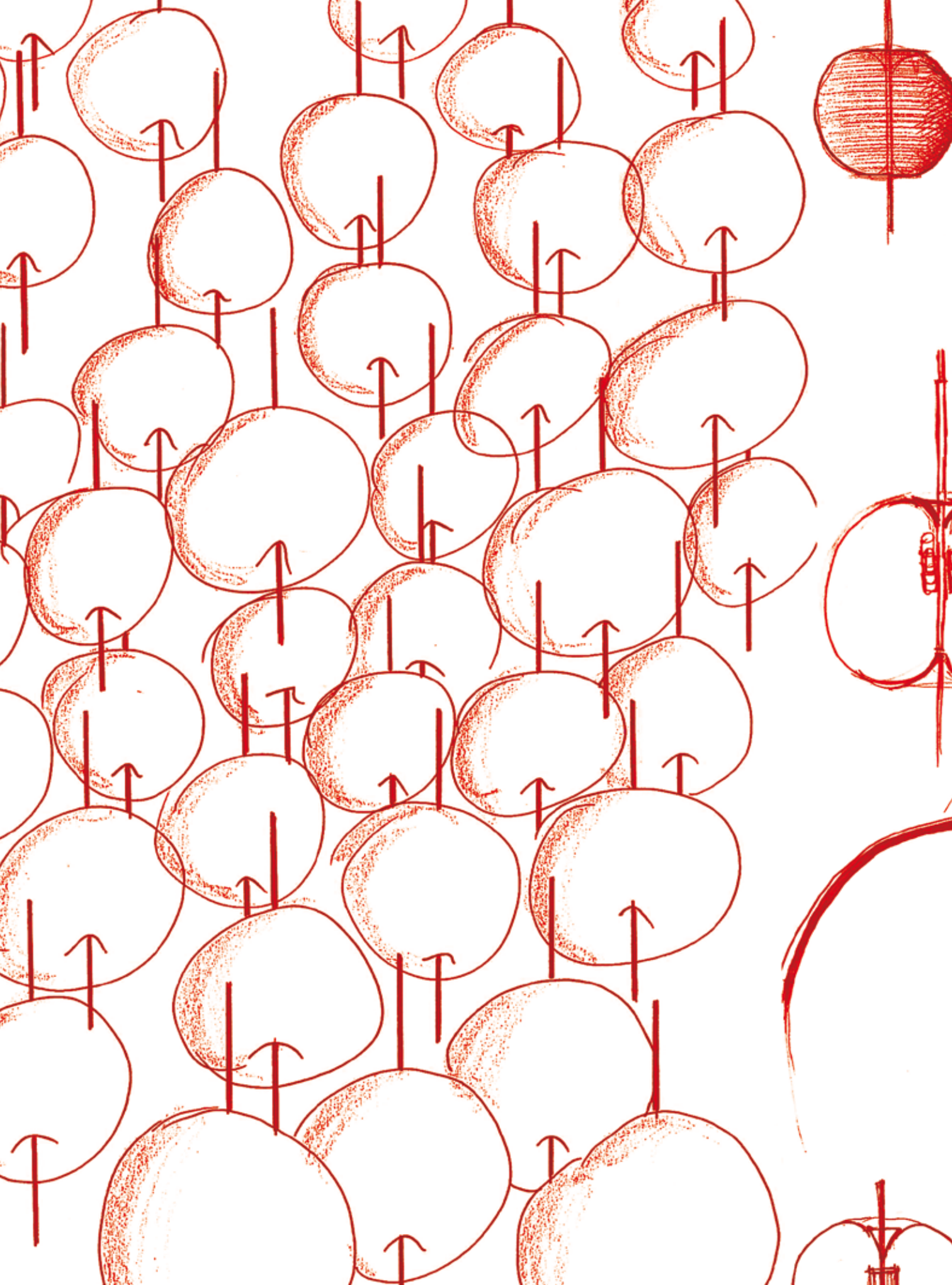



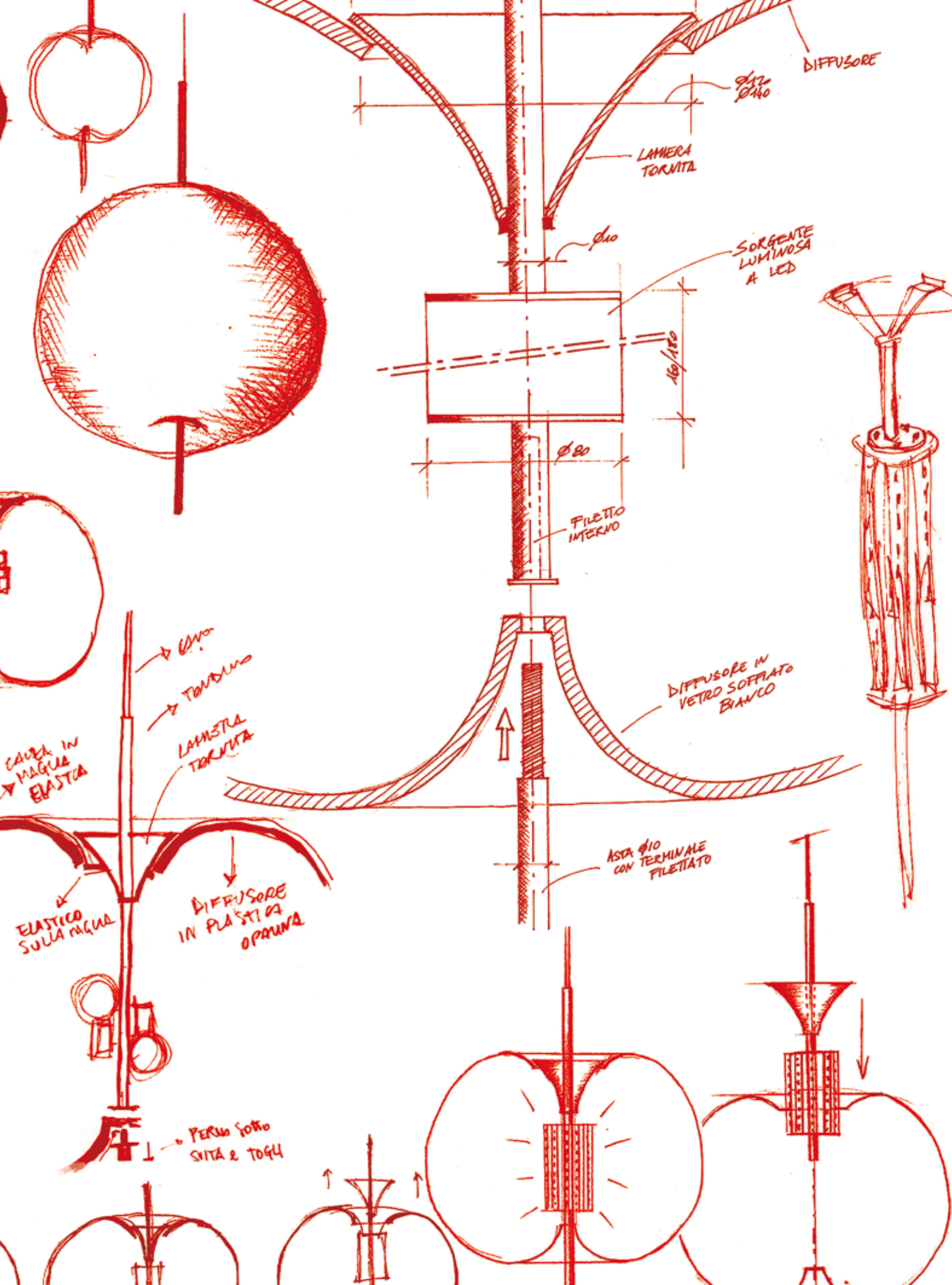



# VISION

*... besides being designed, light in turn designs  
our perception of the world and of life itself ...*

Kundalini is a company with a strong identity and a cosmopolitan style, innovative and sophisticated. A company that speaks a universal yet extremely recognisable language. Its unconventional spirit has always merged the subtle poetry of shape to maximum functionality and handiness, moulding the finest materials through cutting-edge processes.

Every Kundalini product is the fruit of a strong concept and tells the story of a specific creative and technological journey. All are consistent with the corporate philosophy that has always combined an unconventional approach and the search for new aesthetics with a deep knowledge of materials and technologies. Kundalini lamps are characterised by a sense of colour and geometry that is always fresh and with high creative content, drawing inspiration from time to time from different worlds. Nature, industrial scenarios, the visual arts are just a few of the contexts observed and reinterpreted to create lamps where shape and function are intertwined and complement each other to become inseparable elements, a synthesis that is always perfectly balanced between function and emotion.

The rich and varied collection of Kundalini lamps, always in the making, is the fruit of the collaborative effort of designers and architects of international renown, but also emerging talents who share and enhance the company's mission.

*... la luce non solo è disegnata, ma a sua volta  
disegna la nostra percezione del mondo e della vita ...*

Kundalini è un'azienda caratterizzata da una forte identità e da uno stile cosmopolita, innovativo e sofisticato. È un'azienda che parla un linguaggio universale e al contempo estremamente riconoscibile. Il suo spirito anticonvenzionale unisce da sempre alla sottile poesia della forma la massima funzionalità e praticità d'uso plasmando i migliori materiali attraverso lavorazioni d'avanguardia.

Ogni prodotto Kundalini nasce da un'idea forte e racconta uno specifico percorso creativo e tecnologico. Tutti sono coerenti con la filosofia aziendale che unisce da sempre l'approccio anticonvenzionale e la ricerca di nuove estetiche con una profonda conoscenza dei materiali e delle tecnologie. Le lampade Kundalini sono caratterizzate da un senso del colore e della geometria sempre inedito e ad alto tasso creativo e traggono ispirazione di volta in volta da mondi diversi. La natura, gli scenari industriali, le arti visive sono solo alcuni dei contesti osservati e reinterpretati per dar vita a lampade in cui forma e funzione si intrecciano e si completano fino a divenire elementi inscindibili, una sintesi sempre perfettamente calibrata tra funzione ed emozione.

La ricca e variegata collezione di lampade Kundalini, sempre in divenire, è frutto della collaborazione di designer e architetti di fama internazionale ma anche di talenti emergenti, che condividono ed esaltano la mission dell'azienda.

*... Licht wird nicht nur entworfen,  
Licht entwirft wiederum die Welt und das Leben so wie wir beides wahrnehmen ...*

Das Unternehmen Kundalini zeichnet sich durch eine ganz eigene Identität und einen weltoffenen, innovativen und raffinierten Stil aus. Seine Sprache ist universell und hat gleichzeitig Wiedererkennungswert. Herrschend ist ein unkonventioneller Geist, der seit jeher die zarte Poesie der Form mit größtmöglicher Funktionalität und Zweckmäßigkeit vereint; hierfür werden die besten Materialien in fortschrittlichen Verfahren verarbeitet.

Jedes Kundalini-Produkt entsteht aus einer eigenen Idee und hat seine Geschichte von Kreativität und Technologie. Alle entsprechen der Unternehmensphilosophie, die seit jeher einen unkonventionellen Ansatz und die Suche nach einer neuen Ästhetik mit einer gründlichen Kenntnis der Materialien und Technologien verbindet. Die Lampen von Kundalini zeichnen sich durch einen immer wieder neuen Sinn für Farbe und Geometrie aus, stecken voller Kreativität und sind jedes Mal von anderen Welten inspiriert. Natur, Industrie und darstellende Kunst sind nur einige der Bereiche, die beobachtet und neu interpretiert wurden, um Lampen zu erschaffen, in denen sich Form und Funktion verbinden und ergänzen, so dass sie gar nicht mehr voneinander zu unterscheiden sind - das perfekte Gleichgewicht von Zweckmäßigkeit und Emotion.

Die vielfältige, abwechslungsreiche Lampenkollektion von Kundalini, die sich ständig neu erfindet, ist das Ergebnis einer Zusammenarbeit von Designern und Architekten von Weltruhm, aber auch von Nachwuchstalenten, die ihre Begeisterung für die Mission des Unternehmens teilen.

*... la lumière non seulement est dessinée, mais  
dessine à son tour notre perception du monde et de la vie ...*

Kundalini est une société caractérisée par une forte identité et par un style cosmopolite, innovant et sophistiqué. C'est une société qui parle un langage universel et en même temps extrêmement reconnaissable. Son esprit anti-conventionnel unit depuis toujours à la poésie fine de la forme la fonctionnalité et praticité maximale en modelant les meilleurs matériaux à travers des travaux d'avant-garde.

Chaque produit Kundalini naît d'une idée forte et raconte un parcours créatif et technologique spécifique. Tous sont cohérents avec la philosophie de la société qui unit depuis toujours l'approche anti-conventionnelle et la recherche de nouvelles esthétiques à une connaissance approfondie des matériaux et des technologies. Les lampes Kundalini sont caractérisées par un sens de la couleur et de la géométrie toujours inédit et un niveau de créativité élevé et tirent leur inspiration à chaque fois de mondes différents. La nature, les scénarios industriels, les arts visuels sont seulement quelques-uns des contextes observés et réinterprétés pour donner vie à des lampes dont la forme et fonction se mêlent et se complètent jusqu'à devenir des éléments indivisibles, une synthèse toujours parfaitement calibrée entre fonction et émotion.

La collection riche et variée de lampes Kundalini, toujours en devenir, est le fruit de la collaboration de designers et architectes de réputation internationale mais aussi de talents émergents, qui partagent et exaltent la mission de la société.

*... la luz no está sólo diseñada,  
sino que a su vez diseña nuestra percepción del mundo y de la vida ...*

Kundalini es una empresa que se caracteriza por una fuerte identidad y por un estilo cosmopolita, innovador y sofisticado. Es una empresa que habla un lenguaje universal y contemporáneamente extremadamente reconocible. Su espíritu anticonvencional une, desde siempre, a la sutil poesía de la forma la máxima funcionalidad y el uso práctico plasmando los mejores materiales a través de obras de vanguardia.

Cada producto Kundalini nace de una fuerte idea y relata una específica trayectoria creativa y tecnológica. Todos son coherentes con la filosofía de la empresa que une desde siempre un enfoque anticonvencional y la búsqueda de nuevas estéticas con un profundo conocimiento de los materiales y de las tecnologías. Las lámparas Kundalini están caracterizadas por un sentido del color y de la geometría siempre inédito y con un alto índice creativo y extraen la inspiración, en cada ocasión, de mundos diversos. La naturaleza, los escenarios industriales, las artes visuales son sólo algunos de los contextos observados y reinterpretados para dar vida a las lámparas donde la forma y la función se entrelazan y se completan hasta dar lugar a elementos indivisibles, una síntesis siempre perfectamente calibrada entre función y emoción.

La rica y variada colección de lámparas Kundalini, en constante transformación, es fruto de la colaboración de diseñadores y arquitectos de fama internacional, pero también de talentos emergentes, que comparten y resaltan la misión de la empresa.

# DESIGNERS



Noé Duchaufour Lawrance



Karim Rashid



Sebastian Herkner



Alberto Saggia &  
Valerio Sommella



David Pompa



Ini Archibong



Marco Merendi



Peter Jamieson



Patricia Urquiola



Hansandfranz



Jean Marie Massaud



Patrick Norguet



Norman Foster



Paola Navone



AquiliAlberg



Alessandro Mendini



Brodie Neill



Christophe Pillet



Emmanuel Babled



Benjamin Hopf  
Constantin Wortmann



Helen Kontouris



Osko+Deichmann



John Sebastian



Benjamin Hubert



Serge & Robert Cornelissen



Gregorio Spini



De-Signum



Giorgio Gurioli



Studio 14



Future Systems



Guglielmo Berchicci



Marzio Rusconi Clerici &  
Laura Agnoletto

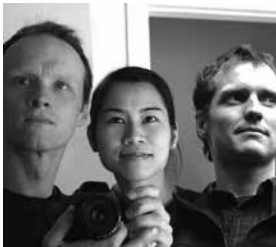

Bakery Group



# INDEX

## FLOOR



Evita / 18



E.T.A. / 56



Floob / 36



Kushi floor / 14

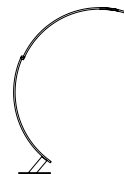

Kyudo / 22



La La Lamp / 40

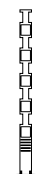

Sama / 52



Shakti / 48



Spillo floor / 26



Spillo outdoor / 30



Tripod floor / 44

TABLE

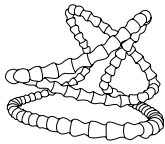

Abyss / 88

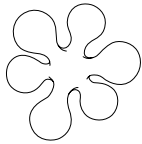

Atomium / 84



Gherkin / 96



Hive / 68

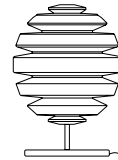

Honeymoon table / 92

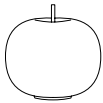

Kushi mobile / 72

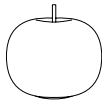

Kushi table / 76

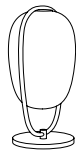

Lannà table / 64

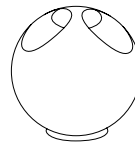

Noglobe table / 100

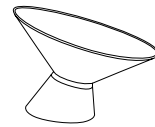

Shen / 80

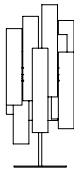

Toot table / 60

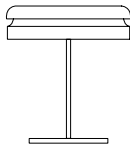

Toric table / 104

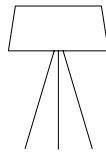

Tripod table / 108

# SUSPENSION

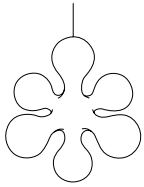

Atomium ceiling / 188

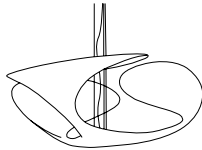

Clover / 164

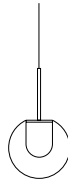

Dew / 176

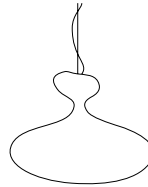

E.T.A. Sat / 224

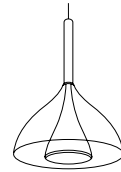

Floob ceiling / 200



Giass / 136



Honeymoon ceiling / 192

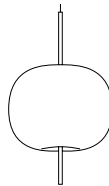

Kushi suspension / 140

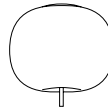

Kushi ceiling / 144



Lannà suspension / 116

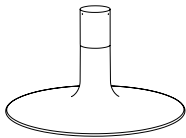

Louis / 160



Minimal / 132

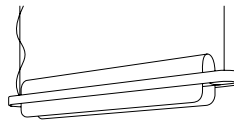

Nami / 120



New York ceiling / 152



Noglobe ceiling / 208

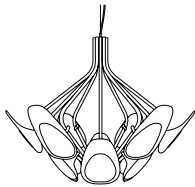

Peacock / 148

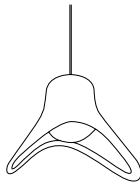

Pluto ceiling / 196



Pipe / 220

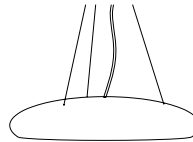

Red Label / 156



Sama ceiling / 216

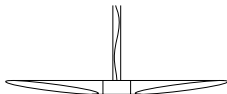

Shakti Sky / 204



Spillo ceiling / 172

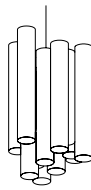

Toot suspension / 112

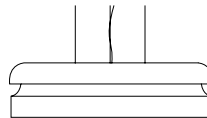

Toric ceiling / 212



Treis / 168

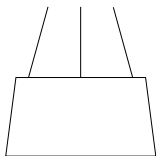

Tripod ceiling / 228

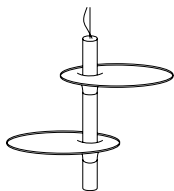

Victoria / 124



Yuma / 128

WALL

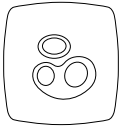

Alone / 268

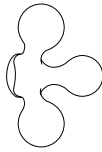

Atomium wall / 260

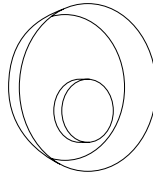

Dawn / 236

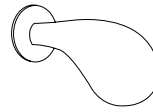

Drop / 264



Evita wall / 252

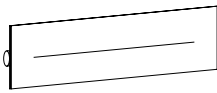

Flap / 276



Frame / 248

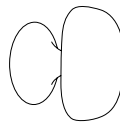

Kinoko / 244

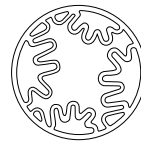

Mandala Mendini / 280

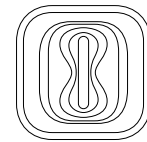

Mandala Rashid / 284

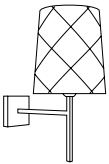

New York wall / 232

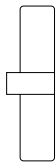

Pastilla / 288

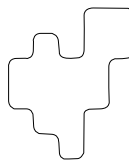

Pixel / 256

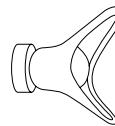

Pluto wall / 292

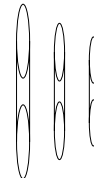

Shakti wall / 272



Tua / 240

# KUSHI floor

ALBERTO SAGGIA & VALERIO SOMMELLA / 2016





# KUSHI<sub>floor</sub>

ALBERTO SAGGIA & VALERIO SOMMELLA / 2016

Dimmable floor lamp. Opal diffuser made of two layers of mouth blown glass. Metallic body available in three coating finishes: black, copper and brass.

Lampada da terra dimmerabile. Diffusore in vetro opale incamiciato e soffiato. Struttura in metallo verniciato in tre versioni: nero, rame e ottone.

Dimmbare Stehleuchte. Schirm aus Opalglas, mundgeblasen und zweischichtig. Struktur aus Metall in drei Glanzlackfarben lieferbar: Schwarz, Kupfer und Messing.

Lampadaire avec variation de lumière. diffuseur en verre opalin soufflé double couche. Corps en métal verni disponible en trois finitions: noir, cuivre et laiton.

Lámpara de pie dimerable. difusor de vidrio ópalo enfundado y soplado. Cuerpo de metal barnizado disponible en tres acabados: negro, cobre y latón.

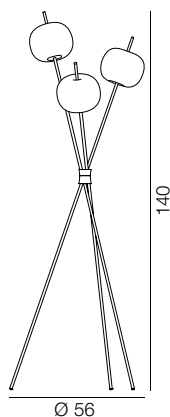

## colours

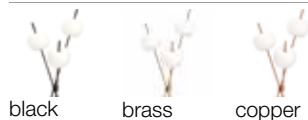

black

brass

copper

## finishing

acid etched glass

## dimensions

Ø 56 - H 140 cm

## bulbs

board led 3x4,6W - 2700K - 1900lm

## feeding

220-240 / 120 V

## dimmer

yes

## certifications

☐ CE IP20  
energy efficiency class A+





# EVITA

AQUILIALBERG / 2011





# EVITA

AQUILIALBERG / 2011

Dimmable floor lamp. Composite body structure of multilayered steel and technopolymers, opal matt diffuser.

Lampada da terra dimmerabile. Struttura composta in multistrato accoppiato di acciaio e tecnopolimeri, diffusore opalino satinato.

Dimmbare Stehleuchte. Struktur aus mehrschichtiger Paarung von Stahl und Technopolymer, Diffusor opalin satiniert.

Lampadaire avec variation de lumière. Structure composite en multicouche acier et technopolymère, diffuseur opalin satiné.

Lámpara de pie dimerable. Estructura compuesta de un multiestrato apareado de acero y tecnopolímero, difusor en opalino satinado.

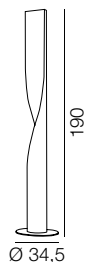

## colours



## finishing

gloss

## dimensions

Ø 34,5 - H 190 cm

## bulbs

evita

fluo  $\longleftrightarrow$  2x54W T5

evita led

board led 4x15W - 2700K - 6000lm - CRI>80

## feeding

220-240 / 120 V

## dimmer

yes

## certifications

Ⓢ CE IP20

energy efficiency class A+





# KYUDO

HANSANDFRANZ / 2010







# KYUDO

HANSANDFRANZ / 2010

Floor lamp with diffuser mounted on adjustable sliding track. Extruded aluminium body with glossy varnish coating. Low voltage Led strip.

Lampada da terra con diffusore montato su binario scorrevole regolabile a piacere. Struttura in estruso di alluminio verniciato lucido. Led strip a bassa tensione.

Stehleuchte, mit einem Diffusor auf einer Gleitschiene montiert, beliebig regulierbar. Struktur aus glanzlackiertem Aluminiumdruckguss. Led Leuchtstreifen mit Niederspannung.

Lampadaire avec diffuseur réglable monté sur rail coulissant. Structure en aluminium extrudé avec application de vernis lucide. Led strip basse tension.

Lámpara de pie con difusor montado sobre un riel corredizo, regulable. Estructura en extruido de aluminio barnizado brillo. Cable de Led de baja tensión.

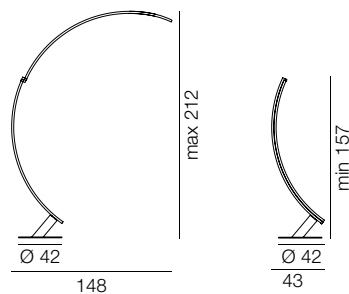

## colours

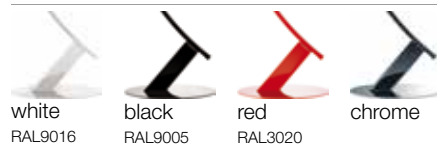

## finishing

gloss powder coated or chromed

## dimensions

Ø 42 - L 43/148 - H 157/212 cm

## bulbs

led strip 2x21,6W - 2700K - 4.200lm - CRI>80

## feeding

220-240 / 120 V

## dimmer

yes

## certifications

CE IP20  
energy efficiency class A+

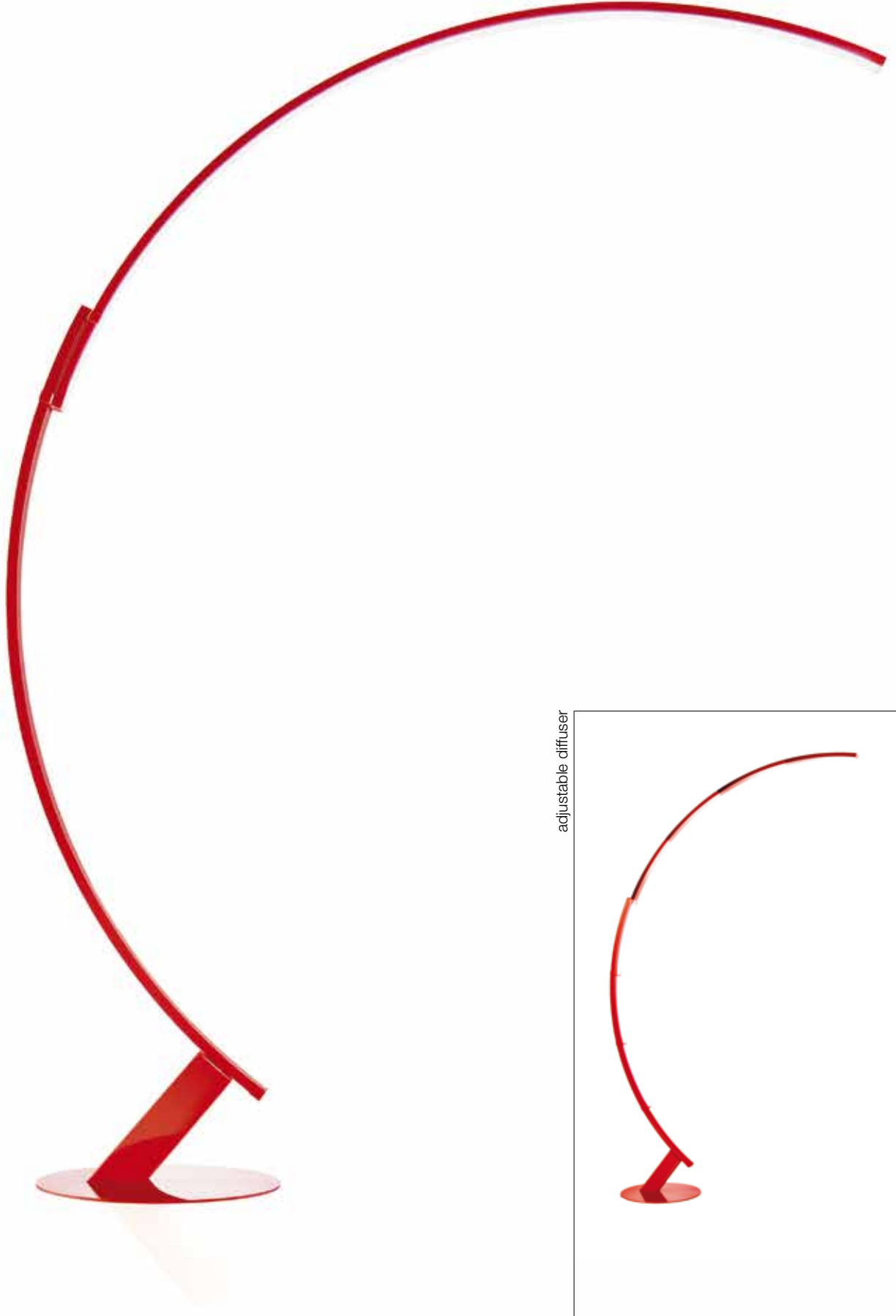

adjustable diffuser



# SPILLO floor

CONSTANTIN WORTMANN / 2010





# SPILLO<sub>floor</sub>

CONSTANTIN WORTMANN / 2010

Floor lamp. Rotational-moulded polyethylene diffuser. Powder coated metal structure and base.

Lampada da terra. Diffusore in polietilene stampato in rotazionale. Struttura e base in metallo verniciato a polveri.

Stehleuchte. Mit Polyethylen diffusor im Rotationsgussverfahren hergestellt. Struktur und Basis aus pulverlackiertem Stahl.

Lampadaire. Diffuseur en polyéthylène moulé par rotation. Structure et base en métal avec application de peinture en poudre.

Lámpara de pie. Difusor en polietileno estampado en rotacional. Estructura y base de metal barnizado con polvos.

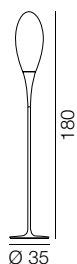

## colours



white

## finishing

gloss powder coated

## dimensions

Ø 35 - H 180 cm

## bulbs

fluo  1x21W E27 (E26US) max Ø50 mm



## feeding

220-240 / 120 V

## dimmer

no

## certifications

  IP20

energy efficiency class from A+ to E





# SPILLO outdoor

CONSTANTIN WORTMANN / 2010







# SPILLO outdoor

CONSTANTIN WORTMANN / 2010





# SPILLO outdoor

CONSTANTIN WORTMANN / 2010

Outdoor floor lamp (IP65). Rotational-moulded polyethylene diffuser. Orange neoprene cord set with IP65 connector. Available with either a peg to enable installation into the ground, a base or a surface mounted base.

Lampada da terra per esterni (IP65). Diffusore in polietilene stampato in rotazionale. Cavo elettrico in neoprene arancione con connettore IP65. Disponibile nella versione a picchetto, con base o con dispositivo fissabile a pavimento.

Außenbodenleuchte (IP65). Mit Polyethylendiffusor im Rotationsgussverfahren hergestellt. Orangefarbenes Neoprenkabel mit IP 65 Verbindungseinheit. Wahlweise verfügbar mit Bodenspieß, Bodenplatte oder verschraubbarer Bodenplatte.

Lampadaire pour extérieur (IP65). Diffuseur en polyéthylène moulé par rotation. Câble électrique en néoprène orange avec dispositif de connexion IP65. Disponible avec piquet, à poser ou avec une système de fixation au sol.

Lámpara de pie para exterior (IP65). Difusor de polietileno estampado en rotacional. Cable eléctrico de neopreno color naranja con conexión IP65. Disponible en la version con piquete, con base o con dispositivo de fijación a suelo.

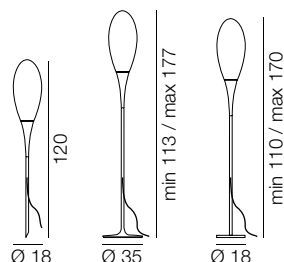

## colours



white

## finishing

gloss powder coated

## dimensions

|               |                     |
|---------------|---------------------|
| outdoor peg   | Ø 18 - H 120 cm     |
| outdoor floor | Ø 35 - H 113/177 cm |
| outdoor fix   | Ø 18 - H 110/170 cm |

## bulbs

fluo  1x21W E27 (E26US) max Ø50 mm



## feeding

220-240 / 120 V

## dimmer

no

## certifications

  IP65  
energy efficiency class from A+ to E





# FLOOR

KARIM RASHID / 2005







# FLOOB

KARIM RASHID / 2005

Uplighter in thermoformed and extruded Plexiglas with spun aluminum reflector.

Lampada da terra a luce indiretta in Plexiglas termoformato ed estruso con riflettore in alluminio tornito.

Stehleuchte aus thermogeformtem, extrudiertem und geblasenem Plexiglas, mit Reflektor aus Aluminiumdrehspäne.

Lampadaire en Plexiglas thermoformé, extrudé et soufflé, avec un réflecteur en aluminium fait au tour.

Lámpara de pie de luz indirecta de Plexiglás termoformado y extruido con reflector de aluminio torneado.

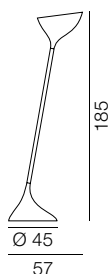

## colours



transp.

orange

fuchsia

## finishing

gloss

## dimensions

Ø 45 - L 57- H 185 cm

## bulbs

halogen  1x105W E27 (E26US) clear tubular

fluo  1x32W E27 (E26US)

led  1x16W E27 (E26US)



## feeding

220-240 / 120 V

## dimmer

no

## certifications

   IP20

energy efficiency class from A+ to E



# LA LA LAMP

HELEN KONTOURIS / 2004





# LA LA LAMP

HELEN KONTOURIS / 2004

Floor lamp made of two conic fabric shades, coated inside with opaline plastic material.

Lampada da terra composta da due riflettori conici in tessuto accoppiato a materiale plastico opalino.

Stehleuchte aus zwei konischen, außen textilbezogenen Plastikreflektoren.

Lampadaire composée de deux réflecteurs coniques en tissu couplé à du matériel plastique opalin.

Lámpara de pie compuesta por dos reflectores cónicos de tejido combinado con material plástico opalino.

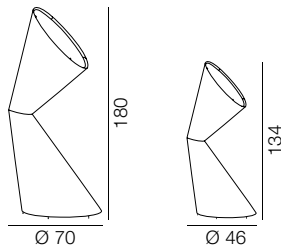

## colours



white

red

## finishing

fabric

## dimensions

la la lamp L      Ø 70 - H 180 cm

la la lamp S      Ø 46 - H 134 cm

## certifications

CE IP20

energy efficiency class from A+ to E

## bulbs

la la lamp L

fluo      2x25W E27 (E26US)

led      2x16W E27 (E26US)

la la lamp S

fluo      2x21W E27 (E26US)

led      2x16W E27 (E26US)

## feeding

220-240 / 120 V

## dimmer

no

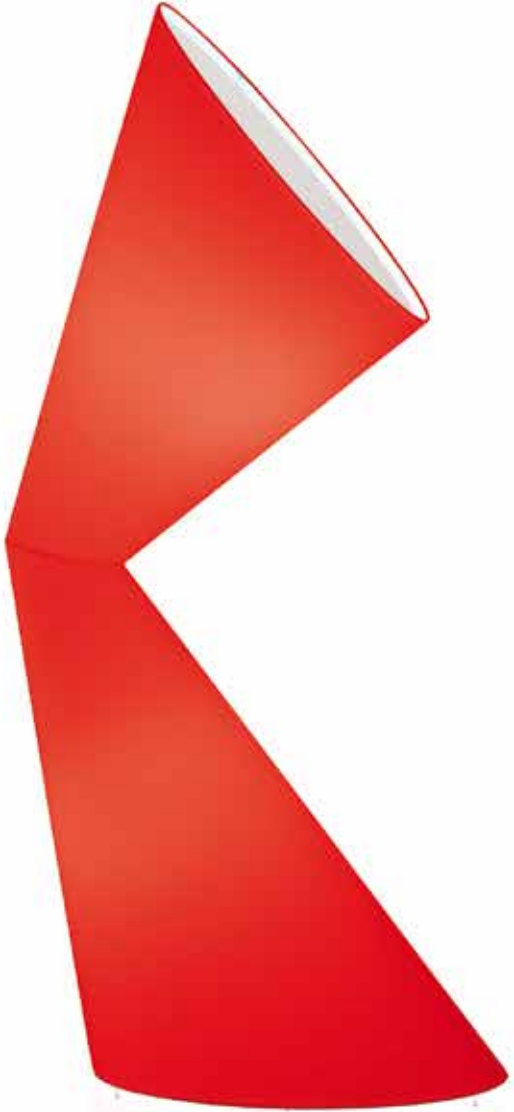



# TRIPOD<sub>floor</sub>

CHRISTOPHE PILLET / 2002







# TRIPOD<sub>floor</sub>

CHRISTOPHE PILLET / 2002

Floor lamp, structure in grey or white painted metal. Shade in fire resistant fabric closed by a painted perforated metal disc.

Lampada da terra, struttura in metallo verniciato grigio o bianco. Paralume in tessuto ignifugo chiuso da disco in metallo microforato e verniciato.

Stehleuchte, grau oder weiss lackierte Metallstruktur. Diffusor aus feuerfestem Stoff, von durchlöcherter eloxierter Aluminiumscheibe verschlossen.

Lampadaire, structure en métal verni gris ou blanc. Diffuseur en tissu ignifuge fermé par un disc en métal micropercé verni.

Lámpara de pie, estructura de metal barnizado gris o blanco. Pantalla de tejido ignifugo fijada con disco de metal microperforado y barnizado.

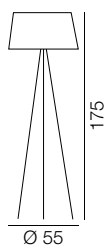

## colours



white

ecru

moka

## finishing

fabric + painted metal

## dimensions

Ø 55 - H 175 cm

## bulbs

halogen  3x70W E27 (E26US) clear tubular

fluo  3x21W E27 (E26US)

led  3x16W E27 (E26US)



## feeding

220-240 / 120 V

## dimmer

yes

## certifications

   IP20

energy efficiency class from A+ to E

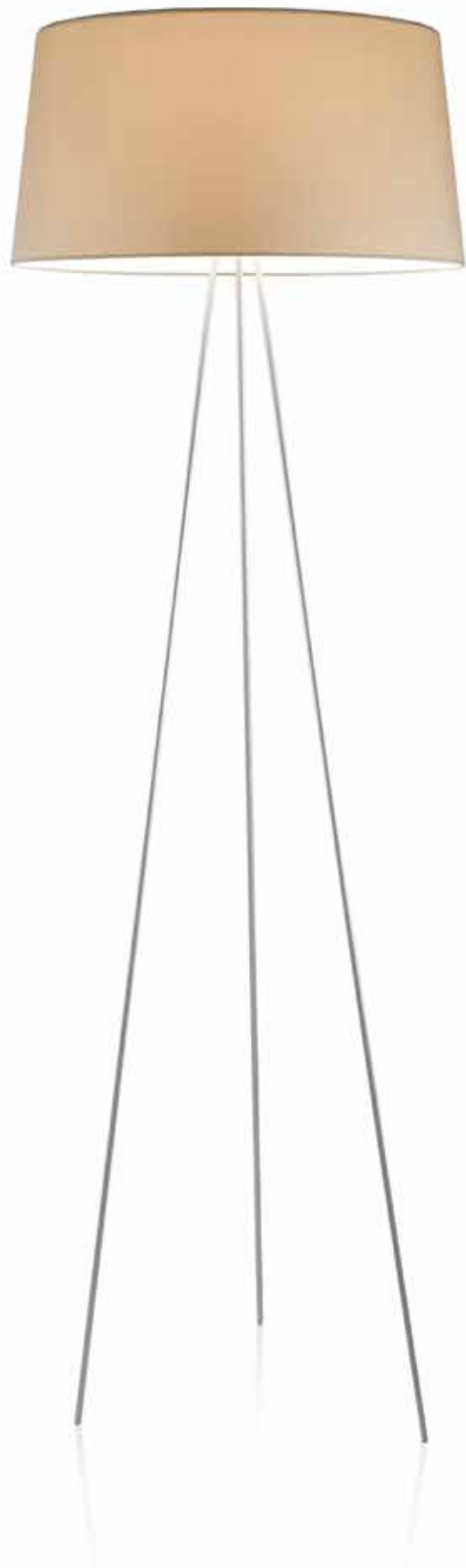

# SHAKTI

MARZIO RUSCONI CLERICI / 2001







# SHAKTI

MARZIO RUSCONI CLERICI / 2001

Shakti is a floor lamp with two lights for reading and ambient that can be dimmed. The light diffuser is a laser cut extruded Plexiglas tube, fixed into a satin finished or polished stainless steel base.

Lampada da terra dimmerabile a due luci, lettura e ambiente, con diffusore tubolare in Plexiglas tagliato a laser e fissato su base d'acciaio satinata o lucidata.

Shakti ist eine Stehleuchte mit zwei dimmbaren Glühlampen, die sowohl Leselicht als auch Umgebungslicht spendet. Der Diffusor ist eine extrudierte und lasergeschnittene Plexiglasröhre, welche wahlweise in einer satinierten oder aus Edelstahl polierten Basis fixiert werden kann.

Lampadaire à deux sources dimmables et un variateur de lumière, pour la lecture et l'ambiance, avec un diffuseur tubulaire en Plexiglas extrudé et coupé laser, qui est fixé sur un socle satiné ou en acier poli.

Lámpara con dimmer de dos luces, para lectura y ambiente, con difusor tubular de Plexiglas extruido y cortado con láser y fijado sobre base de acero satinado o brillo.

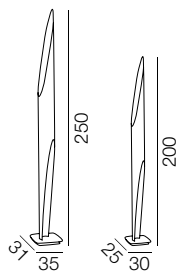

## colours

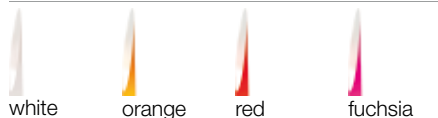

## finishing

gloss



satin base polished base

## dimensions

shakti 200 L 30 - W 25 - H 200 cm  
shakti 250 L 35 - W 31 - H 250 cm

## bulbs

shakti 200  
halogen 2x70W E27 (E26US) clear tubular  
fluo 2x21W E27 (E26US)  
led 2x16W E27 (E26US)  
shakti 250  
halogen 2x105W E27 (E26US) clear tubular  
fluo 2x25W E27 (E26US)  
led 2x16W E27 (E26US)

## feeding

220-240 / 120 V

## dimmer

yes

## certifications

IP20  
energy efficiency class from A+ to E





# SAMA

GREGORIO SPINI / 2003



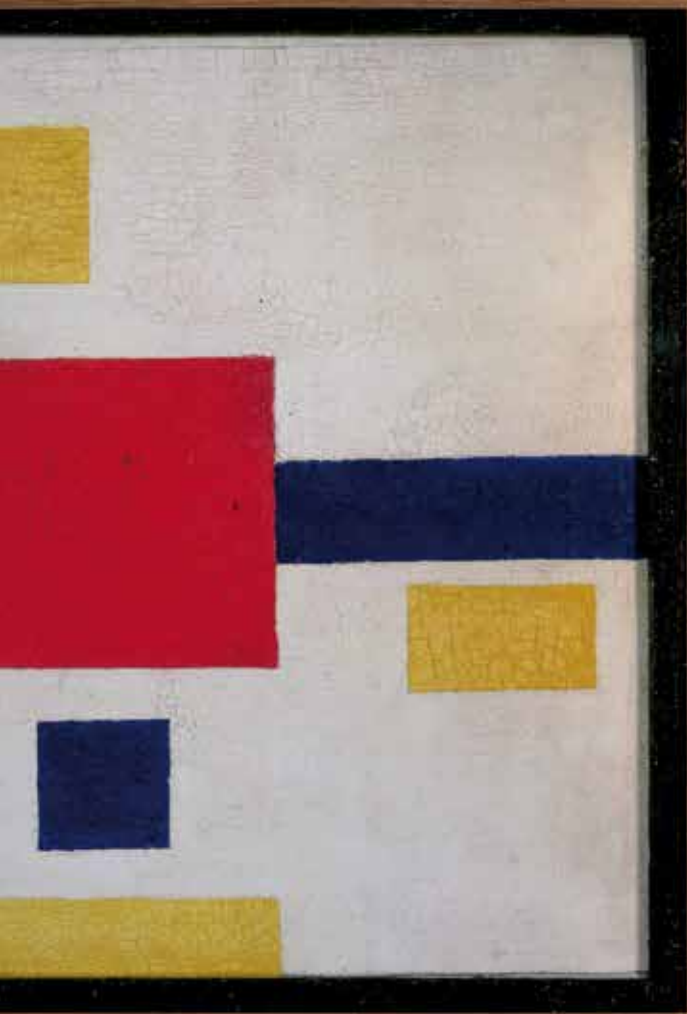

# SAMA

GREGORIO SPINI / 2003

Floor lamp in two tone coextruded and laser cut Plexiglas, inserted in a chrome plated steel base.

Lampada da terra in Plexiglas bicolore coestruso e tagliato a laser, inserita in una base d'acciaio cromato.

Stehleuchte mit einem zweifarbig coextrudierten lasergeschnittenen Plexiglasdiffusor. Stahlfuß verchromt.

Lampadaire en Plexiglas co-extrudé bicolore et coupé laser, encastré dans un socle en acier chromé.

Lámpara de pie de Plexiglás bicolor co-extruido y cortado con láser, colocada sobre una base de acero cromado.

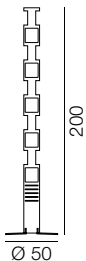

## colours



orange



red



fuchsia



## finishing

gloss

## dimensions

Ø 50 - H 200 cm

## bulbs

halogen  1x75W E27 (E26US) PAR30 dichroic  
led  1x9W E27 (E26US) PAR30



## feeding

220-240 / 120 V

## dimmer

yes

## certifications

  IP20  
energy efficiency class from A+ to E





E.T.A.

GUGLIELMO BERCHICCI / 1996







# E.T.A.

GUGLIELMO BERCHICCI / 1996

Floor lamp. Handmade light diffuser in ecological fibreglass, metallic inner structure (removable for bulbs changing), dimmer.

Lampada da terra. Corpo diffusore in vetroresina ecologica lavorato a mano, struttura interna in metallo (rimovibile per la sostituzione delle lampadine), dimmer.

Stehleuchte. Handgefertigter Diffusor aus ökologischem Fiberglas, interne metallene Leuchtmittelhalterung (herausnehmbar um die Leuchtmittel auszuwechseln), Dimmer.

Lampadaire. Diffuseur en fibre de verre écologique fait à la main, structure intérieure en métal (détachable pour changer les ampoules), variateur de lumière.

Lámpara de pie. Cuerpo difusor de resina de vidrio ecológica trabajado a mano, estructura interna de metal (extraible para poder sustituir las bombillas), dimmer.

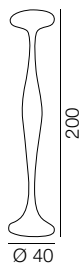

## colours









## finishing

coloured fibreglass

## dimensions

Ø 40 - H 200 cm

## bulbs

halogen  3x42W E14 (E12US) clear olive +  
 1x105W E27 (E26US) clear tubular  
fluo  3x12W E14 (E12US) candle +  
 1x32W E27 (E26US) tubular  
led  3x6W E14 (E12US) candle +  
 1x16W E27 (E26US)



## feeding

220-240 / 120 V

## dimmer

yes

## certifications

  IP20

energy efficiency class from A+ to E



# TOOT<sub>table</sub>

KARIM RASHID / 2017

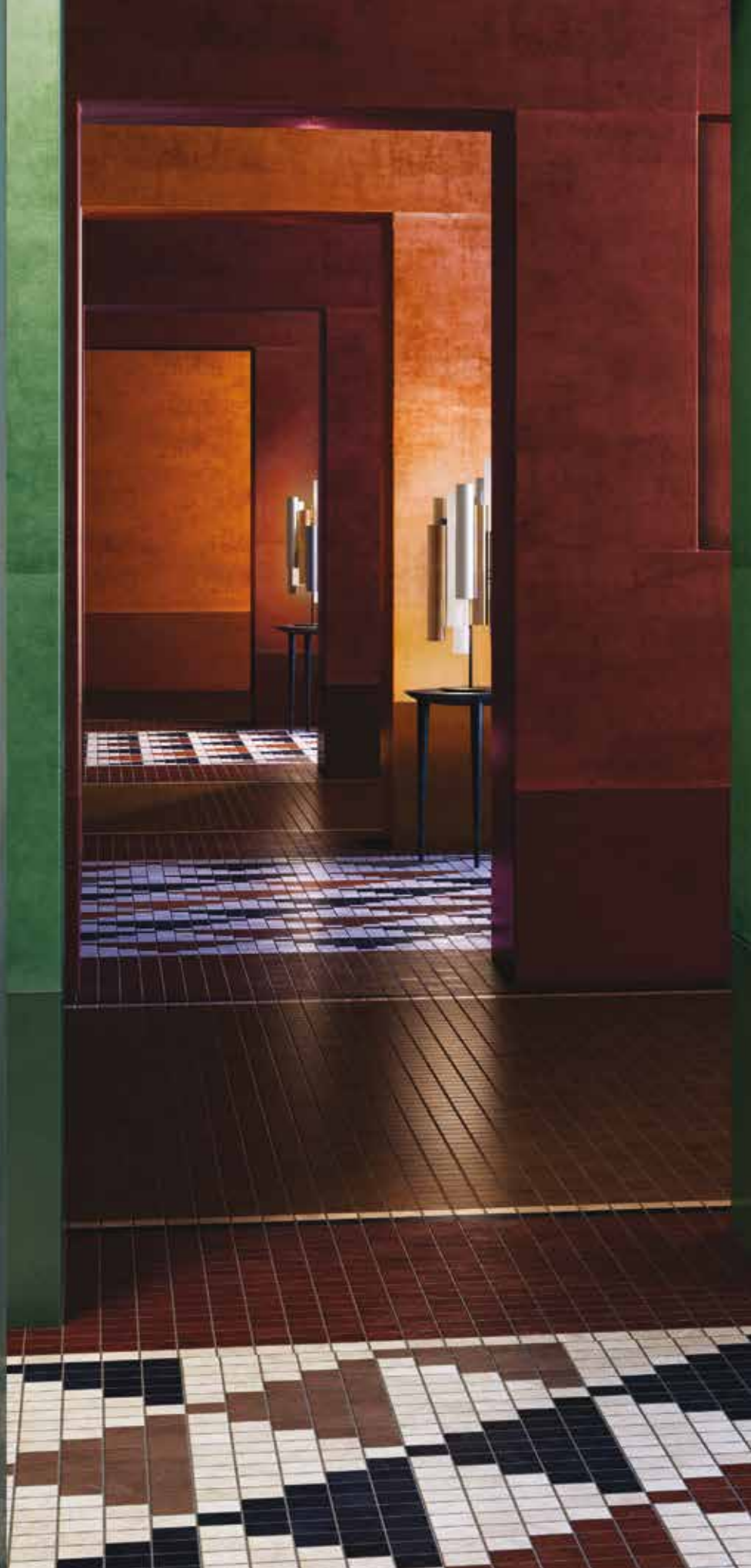



# TOOT table

KARIM RASHID / 2017

Table lamp. Coloured or satin Plexiglas diffusers. Metallic coated structure.

Lampada da tavolo. Diffusori in Plexiglas colorato o satinato. Struttura in metallo verniciato.

Tischleuchte. Farbige oder satinierte Plexiglasdiffusoren. Struktur aus Metall in Glanzlackoptik.

Lampe de table. Diffuseurs en Plexiglas coloré ou givré. Structure en métal verni.

Lámpara de mesa. Difusores de Plexiglás coloreado o satinado. Estructura de metal barnizado.

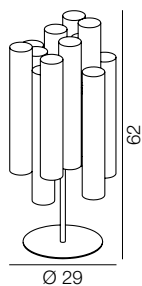

## colours



mixed colours

## finishing

coloured + satin

## dimensions

Ø 29 - H 62 cm

## bulbs

board led 3x5,4W - 2700K - 2100lm

## feeding

220-240 / 120 V

## dimmer

yes

## certifications

CE IP20

energy efficiency class A+





# LANNA' table

NOE' DUCHAUFOR LAW RANCE / 2017





# LANNA' table

NOE' DUCHAUFOR LAW RANCE / 2017

Table lamp. Opal diffuser made of two layers of blown glass. Metallic coated structure.

Lampada da tavolo. Diffusore in vetro opale incamiciato e soffiato. Struttura in metallo verniciato.

Tischleuchte. Schirm aus mundgeblasenem und zweischichtigem Opalglas. Struktur aus Metall in Glanzlackoptik.

Lampe de table. Diffuseur en verre opalin soufflé double couche. Structure en métal verni.

Lámpara de mesa. Difusor de vidrio ópalo enfundado y soplado. Estructura de metal barnizado.

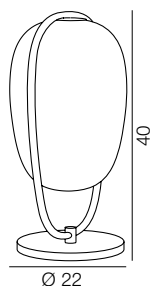

## colours



brass



## finishing

polished + acid etched glass

## dimensions

Ø 22 - H 40 cm

## bulbs

fluo  1x30W E27 (E26US) max Ø60 mm or  
led  1x16W E27 (E26US) max Ø60 mm



## feeding

220-240 / 120 V

## dimmer

no

## certifications

  IP20  
energy efficiency class from A+ to E





# HIVE

INI ARCHIBONG / 2017







# HIVE

INI ARCHIBONG / 2017

Table lamp. Opal diffuser made of two layers of blown glass. Enamel ceramic body decorated with the "third firing" technique.

Lampada da tavolo. Diffusore in vetro opale incamiciato e soffiato. Corpo in ceramica smaltata e decorata con la tecnica del "terzo fuoco".

Tischleuchte. Schirm aus mundgeblasenem und zweischichtigem Opalglas. Email-Keramikkörper verziert mit der „Dreiphasenbrand“ Methode.

Lampe de table. Diffuseur en verre opalin soufflé double couche. Corps en céramique émaillée et décorée avec la technique de "petit feu".

Lámpara de mesa. Difusor de vidrio ópalo enfundado y soplado. Cuerpo de cerámica esmaltada y decorada con la técnica de "tercer fuego".

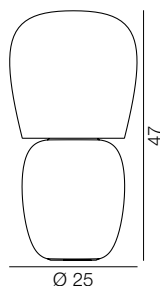

## colours



white

black

red



## finishing

gloss + acid etched glass

## dimensions

Ø 25 - H 47 cm

## bulbs

fluo  1x30W E27 (E26US) or  
led  1x16W E27 (E26US)



## feeding

220-240 / 120 V

## dimmer

no

## certifications

  IP20  
energy efficiency class from A+ to E





# KUSHI mobile

ALBERTO SAGGIA & VALERIO SOMMELLA / 2017





# KUSHI<sub>mobile</sub>

ALBERTO SAGGIA & VALERIO SOMMELLA / 2017

Table lamp with rechargeable battery. Opal diffuser made of two layers of mouth blown glass. Metallic body available in three coating finishes: black, copper and brass.

Lampada da tavolo con batteria ricaricabile. Diffusore in vetro opale incamiciato e soffiato. Struttura in metallo verniciato in tre versioni: nero, rame e ottone.

Tischleuchte mit Akku. Schirm aus mundgeblasenem und zweischichtigem Opalglas. Struktur aus Metall in drei Glanzlackfarben lieferbar: Schwarz, Kupfer und Messing.

Lampe de table avec batterie rechargeable. Diffuseur en verre opalin soufflé double couche. Corps en métal verni disponible en trois finitions: noir, cuivre et laiton.

Lámpara de mesa con baterías recargables. Difusor de vidrio ópalo enfundado y soplado. Cuerpo de metal barnizado disponible en tres acabados: negro, cobre y latón.

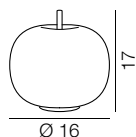

## colours



black

brass

copper

## finishing

acid etched glass

## dimensions

Ø 16 - H 17 cm

## bulbs

board led 1x1,3W - 2700K - 150lm

## feeding

rechargeable battery  
3,2V LiFe 2000 mAh

## dimmer

no

## certifications

◆ CE IP20  
energy efficiency class A+





# KUSHI table

ALBERTO SAGGIA & VALERIO SOMMELLA / 2015





# KUSHI table

ALBERTO SAGGIA & VALERIO SOMMELLA / 2015

Table lamp. Opal diffuser made of two layers of mouth blown glass. Metallic body available in three coating finishes: black, copper and brass.

Lampada da tavolo. Diffusore in vetro opale incamiciato e soffiato. Struttura in metallo verniciato in tre versioni: nero, rame e ottone.

Tischleuchte. Schirm aus Opalglas, mundgeblasen und zweischichtig. Struktur aus Metall in drei Glanzlackfarben lieferbar: Schwarz, Kupfer und Messing.

Lampe de table. diffuseur en verre opalin soufflé double couche. Corps en métal verni disponible en trois finitions: noir, cuivre et laiton.

Lámpara de mesa. difusor de vidrio ópalo enfundado y soplado. Cuerpo de metal barnizado disponible en tres acabados: negro, cobre y latón.

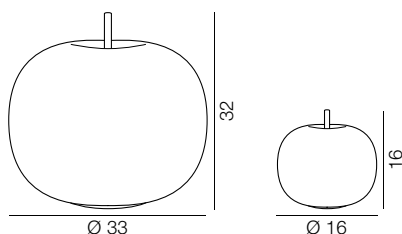

## colours



black

brass

copper

## finishing

acid etched glass

## dimensions

kushi 33

Ø 33 - H 32 cm

kushi 16

Ø 16 - H 16 cm

## dimmer

|              |     |
|--------------|-----|
| kushi 33     | no  |
| kushi 33 led | yes |
| kushi 16     | no  |

## bulbs

kushi 33

fluo  1x30W E27 (E26US) or

led  1x16W E27 (E26 US)

kushi 33 led

board led 1x25W - 2700K - 2500lm



kushi 16

board led 1x5,5W - 2700K - 600lm

## feeding

220-240 / 120 V

## certifications

  IP20

kushi 33

energy efficiency class from A+ to E

kushi 33 led

energy efficiency class A+

kushi 16

energy efficiency class A+





# SHĒN

MARCO MERENDI / 2015





# SHĒN

MARCO MERENDI / 2015

Dimmable table lamp. Transparent metalized glass diffuser, base in waxed, smoothed concrete.

Lampada da tavolo dimmerabile. Diffusore in vetro trasparente metallizzato, base in cemento lisciato con trattamento antimacchia.

Dimmbare Tischleuchte. Diffusor aus transparentem Glas Metall, Fuß aus gewachstem, glatten Beton.

Lampe de table avec variation de lumière. Diffuseur en verre transparent métallisé, base en béton lissé et ciré.

Lámpara de mesa dimerable. Difusor de cristal transparente metalizado, base de hormigón alisado y encerado.

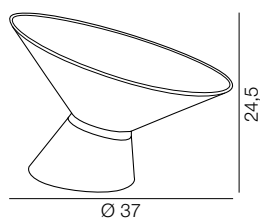

## colours



silver

bronze

violet

## finishing

concrete + metalized glass

## dimensions

Ø 37 - H 24,5 cm

## bulbs

board led 1x14W - 2700K - 1600lm

## feeding

220-240 / 120 V

## dimmer

yes

## certifications

CE IP20

energy efficiency class A+





# ATOMIUM

HOPF&WORTMANN - BÜRO FÜR FORM / 2006







# ATOMIUM

HOPF&WORTMANN - BÜRO FÜR FORM / 2006

Table and floor lamp with rotational-moulded polyethylene diffuser and inner structure with six light sources fixed on steel coil springs.

Lampada da tavolo e da terra con diffusore in polietilene stampato in rotazionale e struttura interna a sei luci montate su molle tensionate in acciaio.

Tisch- und Bodenleuchte mit Polyethylen diffusor im Rotationsgussverfahren hergestellt, innen Federstruktur aus Stahl mit sechs Lampen.

Lampe de table e de terre avec un diffuseur en polyéthylène imprimé en rotoroulage et une structure intérieure à six luminaires placées sur des ressorts tensionnés en acier.

Lámpara de mesa y de pie con difusor de polietileno estampado en rotacional con estructura interna de seis luces montadas sobre resortes tensados de acero. Cable autoportante con alma de acero.

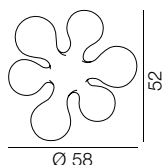

## colours



white

## finishing

gloss

## dimensions

Ø 58 - H 52 cm

## bulbs

halogen  6x40W E14 (E12US) clear

fluo  6x12W E14 (E12US)

led  6x6W E14 (E12US)



## feeding

220-240 / 120 V

## dimmer

no

## certifications

   IP20

energy efficiency class from A+ to E



# ABYSS

OSKO+DEICHMANN / 2007









# ABYSS

OSKO+DEICHMANN / 2007

Table lamp with high voltage Led strip and modular structure in injection moulded opal polycarbonate.

Lampada da tavolo con filo di Led a tensione di rete e struttura modulare portante in policarbonato opalino stampato a iniezione.

Tischleuchte mit Hochvolt Led Streifen und Modularstruktur aus opalem Polycarbonat in Spritzgussform.

Lampe de table avec un fil de Led à haute voltage et structure modulaire portante en polycarbonate opale moulé à injection.

Lámpara de mesa con cable de Led de tensión de red y estructura modular portante de policarbonato opalino estampado a inyección.

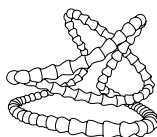

## colours



white

## finishing

gloss

## dimensions

L 300 cm

## bulbs

led strip 1x10W - 3000K - 600lm

## feeding

220-240 / 120 V

## dimmer

no

## certifications

☐ CE IP20

energy efficiency class A+



# HONEYMOON table

JOHN SEBASTIAN / 2007





# HONEYMOON table

JOHN SEBASTIAN / 2007

Table lamp with opal mouth blown triplex glass diffuser. Base in spun opaque-white varnished metal.

Lampada da tavolo con diffusore in vetro opale incamiciato e soffiato. Struttura in metallo tornito verniciato bianco opaco.

Tischleuchte mit Leuchtkörper aus mundgeblasenem, opalem Triplexglas. Metallstruktur in mattem weiß lackiert.

Lampe de table au diffuseur en verre opale soufflé triplex. Structure en métal verni blanc opaque.

Lámpara de mesa con difusor de vidrio ópalo enfundado y soplado. Estructura de metal torneado barnizado blanco opaco.

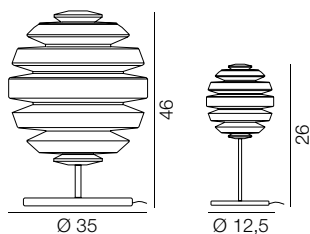

## colours



white

## finishing

gloss glass + matt powder coated





## dimensions

honeymoon L    Ø 35 - H 46 cm  
honeymoon S    Ø 12,5 - H 26 cm

## dimmer

no



## bulbs

honeymoon L  
halogen  1x70W E27 (E26US) clear tubular  
fluo  1x18W E27 (E26US)  
led  1x16W E27 (E26US)  
honeymoon S  
halogen  1x33W G9 clear  
led  1x2,5W G9

## feeding

220-240 / 120 V

## certifications

honeymoon L  
  **CE** IP20  
energy efficiency class from A+ to E  
honeymoon S  
 **CE** IP20  
energy efficiency class A+, D





# GHERKIN

NORMAN FOSTER / 2005





# GHERKIN

NORMAN FOSTER / 2005

Table lamp with triplex mouth blown glass. Chromed metal base.

Lampada da tavolo con diffusore in vetro incamiciato soffiato. Base in metallo tornito e cromato.

Tischleuchte aus mundgeblasenem Triplexglas, mit verchromter Metallbasis.

Lampe de table avec un diffuseur en verre soufflé triplex. Base en acier chromé.

Lámpara de mesa con difusor de vidrio enfundado, soplado. Base de metal torneado y cromado.

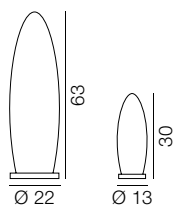

## colours



white







## finishing

gloss glass + chromed base

## dimensions

gherkin 60      Ø 22 - H 63 cm  
gherkin 30      Ø 13 - H 30 cm

## bulbs

gherkin 60  
halogen  1x70W E27 (E26US) clear tubular  
fluo  1x18W E27 (E26US) tubular  
led  1x16W E27 (E26US)  
gherkin 30  
halogen  1x42W E14 (E12US) clear olive  
fluo  1x12W E14 (E12US) candle  
led  1x6W E14 (E12US) candle



## feeding

220-240 / 120 V

## dimmer

yes

## certifications

  **CE** IP20  
energy efficiency class from A+ to E





# NOGLOBE

LAURA AGNOLETTO | MARZIO RUSCONI CLERICI/ 2004





# NOGLOBE

LAURA AGNOLETTO | MARZIO RUSCONI CLERICI/ 2004

Table and floor lamp, made of a white acrylic sphere with three elliptic laser cut holes and chromed spun steel structure.

Lampada da tavolo e da terra, costituita da una sfera in acrilico bianco con tre fori ellissoidali tagliati a laser e struttura in acciaio tornito e cromato.

Boden- oder Tischleuchte, die aus einer weißen Plexiglassphäre mit drei elliptischen Laserausschnitten besteht, montiert auf eine verchromten Stahlstruktur.

Lampe de table ou lampadaire constituée par une sphère en acrylique blanc avec trois ronds à la forme d'une ellipse coupée laser et structure en acier repoussé et chromé.

Lámpara de pie o de mesa, constituida por una esfera de acrílico blanco con tres orificios elipsoidales cortados con láser y estructura de acero torneado y cromado.

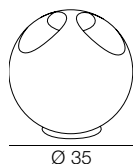

## colours



white



## finishing

gloss + chromed base

## dimensions

Ø 35 cm

## bulbs

fluo  1x21W E27 (E26US) globo Ø102mm  
led  1x9W E27 (E26US) globo Ø102mm



## feeding

220-240 / 120 V

## dimmer

no

## certifications

  IP20  
energy efficiency class from A+ to E



TORIC<sub>table</sub>  
PATRICK NORGUET / 2003







VI Festival  
Internacional  
de

SEATTLE

LIMITED EDITION

# TORIC table

PATRICK NORGUET / 2003

Table lamp with direct light. Structure in white painted metal. Reflector in black/white or orange/white painted metal. Glass diffuser.

Lampada da tavolo a luce diretta. Struttura in metallo verniciato bianco. Riflettore in metallo verniciato bianco/arancio o bianco/nero. Diffusore in vetro.

Tischleuchte mit direktem Licht. Weiss lackierte Metallstruktur. Reflektor in weiss-orangem oder weiss-schwarzem Metall. Glasdiffusor.

Lampe de table avec lumière directe. Structure en métal verni blanc. Réflecteur en métal verni blanc/orange ou blanc/noir. Diffuseur en verre.

Lámpara de mesa de luz directa. Estructura de metal barnizado blanco. Reflector de metal barnizado blanco/naranja o blanco/negro. Difusor de vidrio.

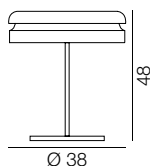

## colours



white / orange  
RAL9010 / RAL2009



white / black  
RAL9010 / RAL9011

## finishing

gloss powder coated

## dimensions

Ø 38 - H 48 cm

## bulbs

fluo  4x12W E14 (E12US)

led  4x6W E14 (E12US)



## feeding

220-240 / 120 V

## dimmer

no

## certifications

   IP20

energy efficiency class from A+ to E



TRIPOD table

CHRISTOPHE PILLET / 2002









# TRIPOD table

CHRISTOPHE PILLET / 2002

Table lamp, structure in grey or white painted metal. Shade in fire resistant fabric closed by a painted perforated metal disc.

Lampada da tavolo, struttura in metallo verniciato grigio o bianco. Paralume in tessuto ignifugo chiuso da disco in metallo microforato e verniciato.

Tischleuchte, grau oder weiss lackierte Metallstruktur. Diffusor aus feuerfestem Stoff, von durchlöcherter eloxierter Aluminiumscheibe verschlossen.

Lampe de table, structure en métal verni gris ou blanc. Diffuseur en tissu ignifuge fermé par un disc en métal micropercé verni.

Lámpara de mesa, estructura de metal barnizado gris o blanco. Pantalla de tejido ignifugo fijada con disco de metal microperforado y barnizado.

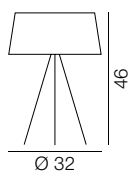

## colours



white

ecrú

moka

## bulbs

halogen 3x40W E14 (E12US) clear  
fluo 3x12W E14 (E12US) candle  
led 3x6W E14 (E12US) candle

## feeding

220-240 / 120 V

## finishing

fabric + painted metal

## dimmer

no

## dimensions

Ø 32 - H 46 cm

## certifications

IP20  
energy efficiency class from A+ to E



# TOOT suspension

KARIM RASHID / 2017





# TOOT suspension

KARIM RASHID / 2017

Suspension lamp. Coloured or satin Plexiglas diffusers. Metallic coated structure.

Lampada a sospensione. Diffusori in Plexiglas colorato o satinato. Struttura in metallo verniciato.

Hängeleuchte. Farbige oder satinierte Plexiglasdiffusoren. Struktur aus Metall in Glanzlackoptik.

Lampe à suspension. Diffuseurs en Plexiglas coloré ou givré. Structure en métal verni.

Lámpara colgante. Difusores de Plexiglás coloreado o satinado. Estructura de metal barnizado.

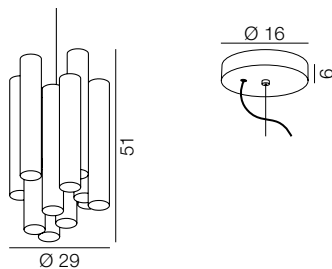

## colours



mixed colours

## finishing

coloured + satin

## dimensions

Ø 29 - H 51 cm

## canopy

black RAL9005

Ø 20 - H 4 cm

## bulbs

board led 3x5,4W - 2700K - 2100lm

## feeding

220-240 / 120 V

## dimmable

1-10V or push

## certifications

Ⓢ CE IP20

energy efficiency class A+





# LANNA' suspension

NOE' DUCHAUFOUR LAWRENCE / 2017







# LANNA' suspension

NOE' DUCHAUFOR LAW RANCE / 2017

Suspension lamp. Opal diffuser made of two layers of blown glass. Metallic coated structure.

Lampada a sospensione. Diffusore in vetro opale incamiciato e soffiato. Struttura in metallo verniciato.

Hängeleuchte. Schirm aus mundgeblasenem und zweischichtigem Opalglas. Struktur aus Metall in Glanzlackoptik.

Lampe à suspension. Diffuseur en verre opalin soufflé double couche. Structure en métal verni.

Lámpara colgante. Difusor de vidrio ópalo enfundado y soplado. Estructura de metal barnizado.

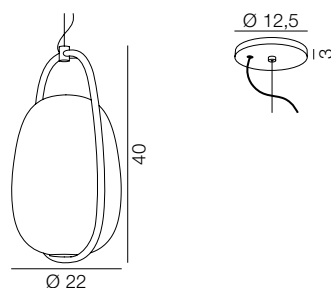

## colours



brass

## finishing

polished + acid etched glass

## dimensions

Ø 22 - H 40 cm

## canopy

brass

Ø 12,5 - H 3 cm

## bulbs



fluo  1x30W E27 (E26US) max Ø60 mm or

led  1x16W E27 (E26US) max Ø60 mm

## feeding

220-240 / 120 V

## certifications

  IP20

energy efficiency class from A+ to E





# NAMI

ALBERTO SAGGIA & VALERIO SOMMELLA / 2017





# NAMI

ALBERTO SAGGIA & VALERIO SOMMELLA / 2017

Suspension lamp with textured and curved glass diffuser. Metallic coated structure.

Lampada a sospensione con diffusore in vetro texturizzato curvato. Struttura in metallo verniciato.

Hängeleuchte mit strukturiertem und gebogenem Glasdiffuser. Beschichtete Metallstruktur.

Lampe à suspension avec diffuseur en verre texturé et courbé. Structure en métal verni.

Lámpara colgante con difusor de vidrio texturizado y curvado. Estructura de metal barnizado.

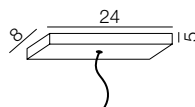
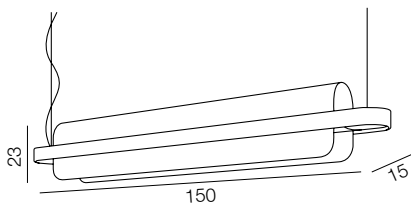

## colours



brass

## finishing

gloss glass

## dimensions

L 150 - W 15 - H 23 cm

## canopy

brass

L 24 - W 8 - H 5 cm

## bulbs

board led 4x14W - 2700K - 4800lm

## feeding

220-240 / 120 V

## dimmable

1-10V

## certifications

Ⓢ CE IP20

energy efficiency class A+



# VICTORIA

ALBERTO SAGGIA & VALERIO SOMMELLA / 2017







# VICTORIA

ALBERTO SAGGIA & VALERIO SOMMELLA / 2017

Suspension lamp. Deep drawn, spun and coated metal body. Satin methacrylate diffusers. Available in two different dimensions.

Lampada a sospensione. Corpo in metallo imbutito, tornito in lastra e verniciato. Diffusori in metacrilato satinato. Disponibile in due dimensioni.

Wandleuchte mit tiefgezogenem, gesponnenem Metallkörper. Satinierter Acrylglassdiffuser. Erhältlich in zwei Größen.

Lampe à suspension avec corps en métal découpé, tourné et verni. Diffuseurs en méthacrylate givré. Disponible en deux dimensions différentes.

Lámpara colgante con cuerpo en metal dibujado y barnizada. Difusores en metacrilato satinado. Disponible en dos distintas dimensiones.

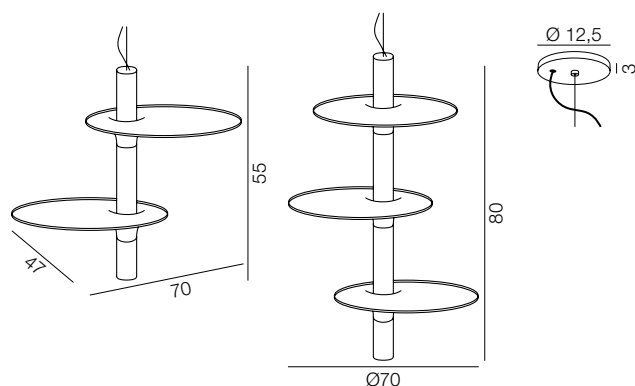

## colours



white

RAL9010

black

RAL9005

## finishing

matt

## dimensions

L 70 - W 47 - H 55 cm

victoria XL

Ø 70 - H 80 cm

## canopy

white RAL9010 or black RAL9005

Ø 12,5 - H 3 cm

## bulbs

board led 2x28W+1x4,8W - 2700K - 5900lm

victoria XL

board led 3x28W+1x4,8W - 2700K - 8600lm

## feeding

220-240 V

## dimnable

phase cut

## certifications

Ⓢ CE IP20

energy efficiency class A+





# YUMA

DAVID POMPA / 2017









# YUMA

DAVID POMPA / 2017

Suspension lamp with spun metal reflector and blown glass diffuser.

Lampada a sospensione con riflettore in metallo tornito in lastra. Diffusore in vetro soffiato.

Hängeleuchte mit direktem Licht. Reflektor aus lasergeschnittenem Metall mit geblasenem Glasdiffuser.

Lampe à suspension avec réflecteur en métal repoussé. Diffuseur en verre soufflé.

Lámpara colgante con reflector de metal torneado y difusor de vidrio soplado.

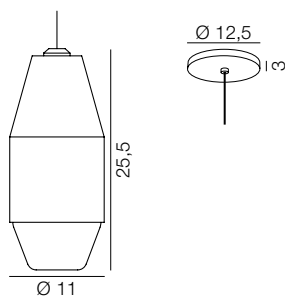

## colours



brass

## finishing

gloss

## dimensions

Ø 11 - H 25,5 cm

## canopy

brass

Ø 12,5 - H 3 cm

## bulbs



fluo  1x30W E27 (E26US) or

led  1x16W E27 (E26US)

## feeding

220-240 / 120 V

## certifications

  IP20

energy efficiency class from A+ to E



# MINIMAL

DAVID POMPA / 2017





RECEPTION



# MINIMAL

DAVID POMPA / 2017

Suspension lamp with handcrafted pottery body and metal structure.

Lampada a sospensione con corpo in ceramica lavorata a mano e struttura in metallo.

Hängeleuchte mit handgemachtem Keramikkörper und Struktur aus Metall.

Lampe à suspension. Corps en céramique à la main et structure en métal.

Lámpara colgante con cuerpo de cerámica hecha a mano y estructura en metal.

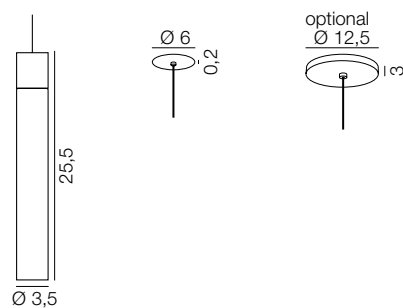

## colours



copper



black nickel

## finishing

polished

## dimensions

Ø 3,5 - H 25,5 cm

## canopy

black RAL9005

Ø 6 - H 0,2 cm

canopy accessory - Ø 12,5 - H 3 cm

## bulbs

board led 1x3,15W - 2700K - 410lm

## feeding

DC 350mA constant current

## dimnable

no

## certifications

◆ CE IP20

minimal + driver

▣ CE IP20

minimal + canopy

⊕ CE IP20

energy efficiency class A+





# GIASS

SEBASTIAN HERKNER / 2017







# GIASS

SEBASTIAN HERKNER / 2017

Ceiling lamp with blown and sandblasted or coloured glass diffuser, available in four different dimensions. Coated metal structure, satin polycarbonate screen.

Lampada a plafone con diffusore in vetro soffiato e sabbiato o colorato, disponibile in quattro diverse dimensioni. Struttura in metallo verniciato, schermo in policarbonato satinato.

Wandleuchte mit geblasenem Glasdiffuser, sandgestrahlt oder vielfarbig, erhältlich in vier verschiedenen Dimensionen. Beschichtete Metallstruktur, Schirm in Polycarbonat satiniert.

Plafonnier avec diffuseur en verre soufflé opalin ou coloré, disponible en quatre dimensions différentes. Structure en métal verni, écran en polycarbonate givré.

Plafón con difusor de vidrio soplado y arenado o coloreado, disponible en cuatro distintas dimensiones. Estructura de metal barnizado, pantalla en policarbonato satinado.

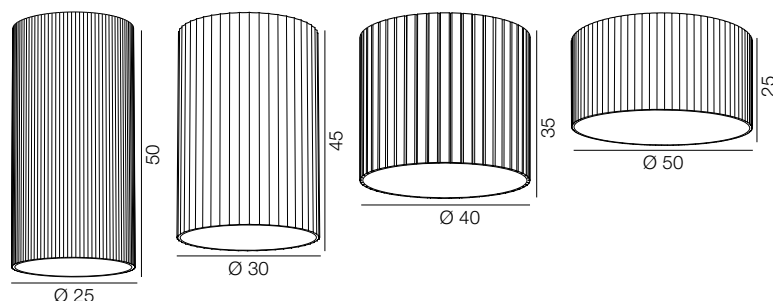

## colours



white



smokey grey

## finishing

sandblasted glass or coloured glass

## dimensions

|          |                |
|----------|----------------|
| giass 25 | Ø 25 - H 50 cm |
| giass 30 | Ø 30 - H 45 cm |
| giass 40 | Ø 40 - H 35 cm |
| giass 50 | Ø 50 - H 25 cm |

## bulbs

giass 25 / giass 30  
board led 1x12W - 2700K - 1570lm  
giass 40 / giass 50  
board led 1x17W - 2700K - 2180lm

## feeding

220-240 / 120 V

## dimnable

1-10V or push

## certifications

Ⓢ CE IP20  
energy efficiency class A+





# KUSHI

ALBERTO SAGGIA & VALERIO SOMMELLA / 2015





# KUSHI suspension

ALBERTO SAGGIA & VALERIO SOMMELLA / 2015

Suspension lamp. Opal diffuser made of two layers of mouth blown glass. Metallic body available in three coating finishes: black, copper and brass.

Lampada a sospensione. Diffusore in vetro opale incamiciato e soffiato. Struttura in metallo verniciato in tre versioni: nero, rame e ottone.

Hängeleuchte. Schirm aus Opalglas, mundgeblasen und zweischichtig. Struktur aus Metall in drei Glanzlackfarben lieferbar: Schwarz, Kupfer und Messing.

Lampe à suspension au diffuseur en verre opalin soufflé double couche. Corps en métal verni disponible en trois finitions: noir, cuivre et laiton.

Lámpara colgante con difusor de vidrio ópalo enfundado y soplado. Cuerpo de metal barnizado disponible en tres acabados: negro, cobre y latón.

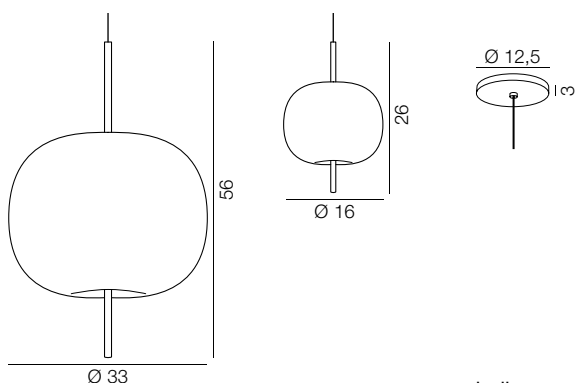

## colours

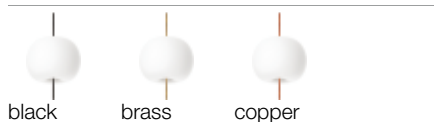

## finishing

acid etched glass

## dimensions

kushi 33

Ø 33 - H 56 cm

kushi 16

Ø 16 - H 26 cm

## canopy

white RAL9010

Ø 12 - H 4,5 cm

## bulbs

kushi 33

fluo  1x30W E27 (E26US) or

led  1x16W E27 (E26 US)

kushi 33 led

board led 1x25W - 2700K - 2500lm

kushi 16

board led 1x5,5W - 2700K - 600lm

## feeding



220-240 / 120 V

## dimmable

kushi 33 led / kushi16

phase cut

## certifications

  IP20

kushi 33

energy efficiency class from A+ to E

kushi 33 led

energy efficiency class A+

kushi 16

energy efficiency class A+



# KUSHI ceiling

ALBERTO SAGGIA & VALERIO SOMMELLA / 2015







# KUSHI ceiling

ALBERTO SAGGIA & VALERIO SOMMELLA / 2015

Ceiling lamp. Opal diffuser made of two layers of mouth blown glass. Metallic body available in three coating finishes: black, copper and brass.

Lampada a plafone. Diffusore in vetro opale incamiciato e soffiato. Struttura in metallo verniciato in tre versioni: nero, rame e ottone.

Wandleuchte. Schirm aus Opalglas, mundgeblasen und zweischichtig. Struktur aus Metall in drei Glanzlackfarben lieferbar: Schwarz, Kupfer und Messing.

Plafonnier. diffuseur en verre opalin soufflé double couche. Corps en métal verni disponible en trois finitions: noir, cuivre et laiton.

Plafón. difusor de vidrio ópalo enfundado y soplado. Cuerpo de metal barnizado disponible en tres acabados: negro, cobre y latón.

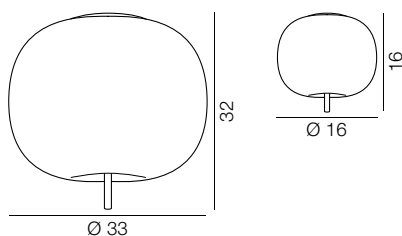

## colours



black brass copper

## finishing

gloss + acid etched glass

## dimensions

kushi 33

Ø 33 - H 32 cm

kushi 16

Ø 16 - H 16 cm

## dimnable

kushi 33 led / kushi16

phase cut

## bulbs

kushi 33

fluo 1x30W E27 (E26US) or

led 1x16W E27 (E26 US)

kushi 33 led

board led 1x25W - 2700K - 2500lm

kushi 16

board led 1x5,5W - 2700K - 600lm

## feeding

220-240 / 120 V

## certifications

CE IP20

kushi 33

energy efficiency class from A+ to E

kushi 33 led

energy efficiency class A+

kushi 16

energy efficiency class A+



# PEACOCK

NOE' DUCHAUFOUR LAWRANCE / 2013







# PEACOCK

NOE' DUCHAUFOUR LAWRENCE / 2013

Suspension lamp with twelve arms. Structure, body and canopy in steel, powder lacquered or acid-etched brass, curved white cased glass shade.

Lampada a sospensione con dodici bracci. Struttura, corpo e rosone in acciaio verniciato a polvere od ottone acidato, diffusore in vetro incamiciato formato a caldo.

Hängeleuchte mit zwölf Armen. Struktur, Körper und Baldachin aus pulverlackiertem Stahl oder in satiniertes Bronzefarbe, Diffusor aus warm geformtes Glas.

Suspension avec douze bras. Structure, corps et rosace en acier découpé verni à poudre ou laiton acidé, diffuseur en verre doublé et formé à chaud.

Lámpara colgante con doce brazos. Estructura, cuerpo y florón en acero barnizado a polvo o en bronce acidado, difusor en vidrio enfundado formado a calor.

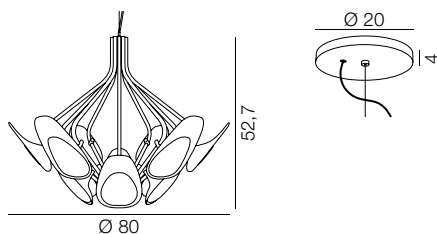

## colours



white  
RAL9010

brass

## finishing

matt powder coated or acid-etched brass

## dimensions

Ø 80 - H 52,7 cm

## canopy

white RAL9010 or brass  
Ø 20 - H 4 cm

## bulbs

board led 12x4,5W - 3000K - 6000lm - CRI>80

## feeding

220-240 / 120 V

## dimmer

yes 1-10 V

## certifications

⊕ CE IP20  
energy efficiency class A+



# NEW YORK

PETER JAMIESON / 2013





# NEW YORK

PETER JAMIESON / 2013

Suspension lamp with multilayered technopolymer reflector and prismatic methacrylate diffuser.

Lampada a sospensione con riflettore in tecnopolimero multistrato e diffusore in metacrilato prismatico.

Hängeleuchte mit Reflektor aus mehrschichtigem Technopolymer und Diffusor in prismatischem Metakrylat.

Suspension avec un réflecteur en technopolymère multicouches et un diffuseur en méthacrylate prismatique.

Lámpara colgante con reflector en multiestrato de tecnopolímero y difusor en metacrilato prismático.

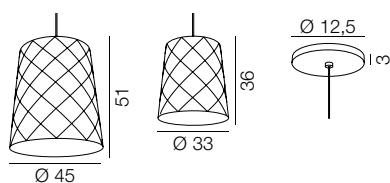

## colours



## finishing

gloss

## dimensions

new york 45      Ø 45 - H 51 cm  
new york 33      Ø 33 - H 36 cm

## canopy

chromed  
Ø 12,5 - H 3 cm

## bulbs

new york 45

fluo      3x max 30W E27 (E26US)

led      3x 13W E27 (E26US)

new york 33

fluo      1x max 30W E27 (E26US)

led      1x 13W E27 (E26US)

## feeding

220-240 / 120 V

## certifications

Ⓢ CE IP20

energy efficiency class from A+ to E





# RED LABEL

SERGE & ROBERT CORNELISSEN / 2013





# RED LABEL

SERGE & ROBERT CORNELISSEN / 2013

Suspension lamp shade in spun aluminum, powder lacquered, technopolymer thermo extensible diffuser. Dimmable version available.

Lampada a sospensione con struttura in alluminio tornito in lastra verniciato a polvere e diffusore in tecnopolimero termo estensibile. Disponibile anche nella versione dimmerabile.

Hängeleuchte mit Aluminiumstruktur, Pulverlackiert in Technopolymer. Auch in dimmbarer Version erhältlich.

Lampe à suspension avec structure en aluminium tourné en plaque verni à poudre et diffuseur en technopolymère termo extensible. Disponible aussi dans la version dimmable.

Lámpara colgante con estructura en aluminio y barnizada a polvo con difusor en tecnopolimero termo extensible. Disponible también en la versión dimerable.

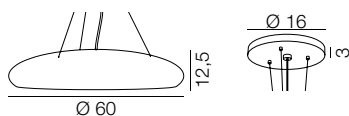

## colours



white  
RAL9016

black  
RAL9004

## finishing

gloss

## dimensions

Ø 60 - H 12,6 cm

## canopy

white RAL9016 or black RAL9004  
Ø 16 - H 3 cm

## bulbs

fluo ○ 1x22W T5c + 1x40W T5c

## feeding

220-240 / 120 V

## dimmer

on request

## certifications

Ⓢ CE IP20  
energy efficiency class A+





# LOUIS

STUDIO 14 / 2013





# LOUIS

STUDIO 14 / 2013

Ceiling lamp with polished rotational-moulded polyethylene diffuser. Powder coated aluminium structure available in three different heights.

Lampada a plafone con diffusore in polietilene stampato in rotazionale e lucidato. Struttura in alluminio verniciato a polvere disponibile in tre diverse altezze.

Wandleuchte mit doppelter Lichtquelle in einem lasergeschnittenen Plexiglasdiffusor. Lieferbar in der Version für elektrischer Wandanschluss, oder verkabelt mit Stecker.

Plafonnier avec diffuseur en polyéthylène imprimé en rotoroulage et poli. Structure en aluminium verni à poudre, disponible en trois hauteurs différentes.

Plafón con difusor de polietileno estampado en rotacional y barnizado a polvo disponible en tres distintas alturas.

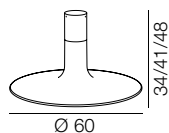

## colours



white

## finishing

gloss

## dimensions

Ø 60 - H 34/41/48 cm

## bulbs



fluo  1x30W E27 (E26US)

led  1x13W E27 (E26US)

## feeding

220-240 / 120 V

## certifications

  IP20

energy efficiency class from A+ to E





# CLOVER

BRODIE NEILL / 2011







# CLOVER

BRODIE NEILL / 2011

Suspension lamp. Moulded polyurethane matt varnished body, aluminium reflector. LED version available.

Lampada a sospensione. Corpo in poliuretano stampato verniciato opaco, riflettore in alluminio. Disponibile nella versione a LED.

Pendelleuchte. Körper aus matt lackiertem und gussgeformtem Polyurethan, Alliuminiumreflektor. Lieferbar in Version aus LED.

Lampe à suspension. Corps en polyuréthane moulée vernis mat, réflecteur an aluminium. Version disponible LED.

Lámpara de suspensión. Estructura en poliuretano pintado mate, reflector en aluminio. Disponible en la versión de LED.

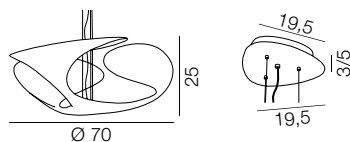

## colours



white  
RAL9016

## finishing

matt liquid varnished

## dimensions

Ø 70 - H 25 cm

## canopy

white RAL9016  
L 19,5 - W 19,5 - H 3 cm



## bulbs

clover  
halogen  2xmax150W B15D  
clover led  
board led 1x25W - 2700K - 2600lm - CRI>80

## feeding

220-240 / 120 V

## certifications

  IP20  
clover energy efficiency class D  
clover led energy efficiency class A+



# TREIS

BENJAMIN HUBERT / 2011







# TREIS

BENJAMIN HUBERT / 2011

Suspension lamp. Deep drawn gloss varnished metal body, prismatic methacrylate diffuser.

Lampada a sospensione. Corpo in metallo imbutito verniciato lucido, diffusore in metacrilato prismatico.

Pendelleuchte. Körper aus glanz lackiertem tiefgezogenem Metall, Diffusor in prismatischem Metakrylat.

Lampe à suspension. Corps en métal découpé vernis brillant, diffuseur en méthacrylate prismatique.

Lámpara de suspensión. Estructura metálica con barniz en brillo, difusor en metacrilato prismático.

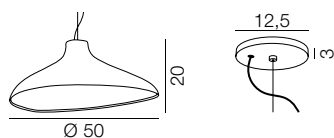

## colours



warm white  
RAL1013

grey  
RAL7039

brown  
RAL8014

## finishing

gloss powder coated

## dimensions

Ø 50 - H 20 cm

## canopy

warm white RAL1013 or grey RAL7039 or brown RAL8014  
Ø 12,5 - H 3 cm

## bulbs

fluo 3xmax12W E14 (E12US)

led 3xmax6W E14 (E12US) candle

## feeding

220-240 / 120 V

## certifications

CE IP20

energy efficiency class from A+ to E



# SPILLO ceiling

CONSTANTIN WORTMANN / 2010





Piccola Biblioteca 274

Arthur Schopenhauer  
L'ARTE DI VIVERE IN RAGIONE



ADELPHI



# SPILLO ceiling

CONSTANTIN WORTMANN / 2010

Indoor and outdoor suspension lamp. Rotational-moulded polyethylene diffuser. Canopy in the indoor version, wiring with IP65 connection device in the outdoor version.

Lampada a sospensione per interni ed esterni. Diffusore in polietilene stampato in rotazionale. Rosone nella versione da interni; cavo elettrico con dispositivo di connessione IP65 nella versione da esterni.

Pendelleuchte für Außen und Innen. Mit Polyethylen-diffusor im Rotationsgussverfahren hergestellt. Baldachin für die Version im Innenbereich; kabel und Verbindungseinheit IP65 für den Aussenbereich.

Suspension pour intérieurs et extérieurs. Diffuseur en polyéthylène moulé par rotation. Rosace dans la version pour intérieur, câble électrique avec dispositif de connexion IP65 dans la version pour extérieur.

Lámpara colgante. Difusor en polietileno estampado en rotacional. Florón en la versión para interiores, cable eléctrico con dispositivo de conexión IP65 en la versión para exteriores.

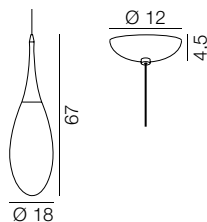

## colours



white

## finishing

gloss powder coated

## dimensions

Ø 18 - H 67 cm

## canopy indoor version only

white

Ø 12 - H 4,5 cm

## bulbs

fluo 1x21W E27 (E26US) max Ø50 mm

## feeding

220-240 / 120 V

## certifications

spillo ceiling indoor

⊕ CE IP20

energy efficiency class from A+ to E

spillo ceiling outdoor

⊞ CE IP65

energy efficiency class from A+ to E





# DEW

EMMANUEL BABLED / 2009





# DEW

EMMANUEL BABLED / 2009

Suspension lamp with glass diffuser and die cast aluminium heat sink. High Voltage Power Led. It can be realized on demand as a multiple pendant chandelier.

Lampada a sospensione con diffusore in vetro e dissipatore in alluminio pressofuso. Led di potenza a tensione di rete. Il prodotto si presta a composizioni multiple realizzabili a richiesta.

Pendelleuchte mit massiver Glaskugel und einem Kühlkörper aus Aluminium, Hochvolt-LED. Auf Anfrage fertigen wir Dew mit einer Vielzahl von Glaskugeln nach Ihren individuellen Vorgaben.

Suspension avec un diffuseur en verre et dissipateur en aluminium moulé sous pression. Led de puissance à haut voltage. Le produit peut être réalisé, sur demande, comme une composition avec plusieurs pendentif.

Lámpara colgante con difusor de vidrio y disipador de aluminio vaciadizo a presión. Led de potencia de tensión de red. El producto se presta para composiciones múltiples realizables a petición del cliente.

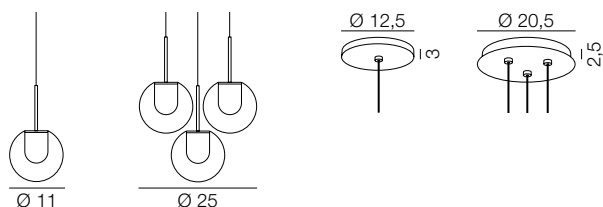

## colours



transparent

## finishing

gloss glass + chromed structure

## dimensions

dew                    Ø 11 cm  
dew3                  Ø 25 cm

## canopy

chromed

dew                    Ø 12,5 - H 3 cm  
dew3                  Ø 20,5 - H 2,5 cm

## bulbs

dew

board led    1x4,2W - 2700K - 320lm - CRI>80

dew3

board led    3x4,2W - 2700K - 960lm - CRI>80

## feeding

220-240 / 120 V

## certifications

CE IP20

energy efficiency class A+





DEW chandelier

EMMANUEL BABLED / 2009





DEW chandelier

EMMANUEL BABLED / 2009







DEW chandelier

EMMANUEL BABLED / 2009







# DEW chandelier

EMMANUEL BABLED / 2009

Dew can be used to create chandeliers in a virtually infinite range of shapes and sizes, giving the designer's imagination a completely free rein. Thanks to the technical and commercial support of the company, all needs can be met, customising each and every aspect of the project with great flexibility.

Dew può essere utilizzata per creare chandelier dalla forma e dalla dimensione pressoché infinite dando il massimo spazio alla libertà compositiva del progettista. Grazie al supporto tecnico e commerciale dell'azienda è possibile soddisfare ogni tipo di esigenza personalizzando con grande flessibilità ogni aspetto del progetto.

Dew kann für die Herstellung von Kronleuchtern in nahezu unbegrenzten Formen und Größen verwendet werden und lässt dem Designer höchste Freiheit beim Entwerfen. Dank der Unterstützung des Unternehmens bei technischen und vertriebsbezogenen Fragen und seiner Flexibilität, alle Aspekte eines Projekts personalisieren zu können, lassen sich alle Wünsche erfüllen.

Dew permet de créer un chandelier dont les formes et la taille sont quasiment infinies. Le designer profite ainsi d'une totale liberté. Grâce à l'assistance technique et commerciale offerte par l'entreprise, nous pouvons répondre à toutes vos exigences en personnalisant chaque aspect de votre projet.

Dew puede utilizarse para crear arañas de formas y tamaños casi infinitos, dando el máximo espacio a la libertad compositiva del proyectista. Gracias a la asistencia técnica y comercial de la empresa, es posible responder a cualquier tipo de exigencia personalizando con gran flexibilidad cada uno de los aspectos del proyecto.





# ATOMIUM ceiling

HOPF&WORTMANN - BÜRO FÜR FORM / 2006







# ATOMIUM<sub>ceiling</sub>

HOPF&WORTMANN - BÜRO FÜR FORM / 2006

Suspension lamp with rotational-moulded polyethylene diffuser and inner structure with six light sources fixed on steel coil springs. Self-clinching supply cable with inserted steel wire.

Lampada a sospensione con diffusore in polietilene stampato in rotazionale con struttura interna a sei luci montate su molle tensionate in acciaio. Cavo autoportante con anima in acciaio.

Hängeleuchte mit Polyethylendiffuser in Rotomoulding, innen Federstruktur aus Stahl mit sechs Lampen. Kabel mit innenliegendem Stahldraht.

Lampe à suspension avec un diffuseur en polyéthylène imprimé en rotoroulage et une structure intérieure à six luminaires placées sur des ressorts tensionnés en acier. Câble autoportant avec une âme en acier.

Lámpara colgante con difusor de polietileno estampado en rotacional con estructura interna de seis luces montadas sobre resortes tensados de acero. Cable autoportante con alma de acero.

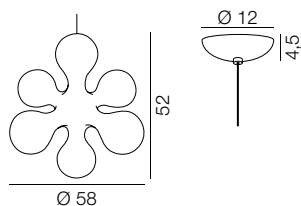

## colours



white

## finishing

gloss

## dimensions

Ø 58 - H 52 cm

## canopy

white

Ø 12 - H 4,5 cm

## bulbs

halogen  6x40W E14 (E12US) clear

fluo  6x12W E14 (E12US)

led  6x6W E14 (E12US)

## feeding

220-240 / 120 V

## certifications

 CE IP20

energy efficiency class from A+ to E



# HONEYMOON ceiling

JOHN SEBASTIAN / 2007





# HONEYMOON ceiling

JOHN SEBASTIAN / 2007

Suspension lamp with opal mouth blown triplex glass diffuser. Fixture in spun opaque white varnished metal.

Lampada a sospensione con diffusore in vetro opale incamiciato e soffiato. Struttura in metallo tornito verniciato bianco opaco.

Hängeleuchte mit Leuchtkörper aus mundgeblasenem, opalem Triplexglas. Metallhalterung in mattem weiß lackiert.

Lampe à suspension au diffuseur en verre opale soufflé triplex. Structure en métal verni blanc opaque.

Lámpara colgante con difusor de vidrio ópalo enfundado y soplado. Estructura de metal torneado barnizado blanco opaco.

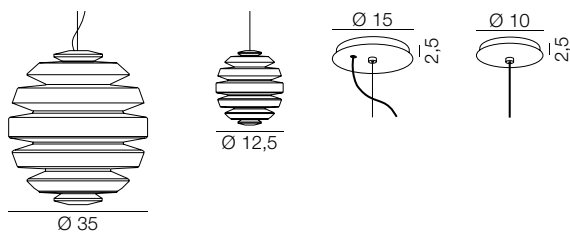

## colours



white

## finishing

gloss

## dimensions

honeymoon L      Ø 35 cm  
honeymoon S      Ø 12,5 cm

## canopy

white

honeymoon L      Ø 15 - H 2,5 cm  
honeymoon S      Ø 10 - H 2,5 cm

## bulbs

honeymoon L

halogen  1x70W E27 (E26US) clear tubular

fluo  1x18W E27 (E26US)

led  1x16W E27 (E26US)

honeymoon S

halogen  1x33W G9 clear

led  1x2,5W G9

## feeding

220-240 / 120 V

## certifications

honeymoon L

 CE IP20

energy efficiency class from A+ to E

honeymoon S

 CE IP20

energy efficiency class A+, D





# PLUTO ceiling

PAOLA NAVONE / 2006





# PLUTO ceiling

PAOLA NAVONE / 2006

Suspension lamp with out of mould mouth-blown diffuser, rotationally-formed and internally sand-blasted. This artistic craftwork makes any and each product unique. This irregularly shaped glass is assembled on chrome-plated metal fixtures. Silicon supply cable with intertwined poles.

Lampada a sospensione con diffusore in vetro soffiato a spessore fuori stampo, lavorato in rotazione e internamente sabbiato. Questa lavorazione artistica rende unico ogni singolo prodotto. Il vetro dalla forma irregolare è fissato a particolari metallici cromati. Alimentazione con cavo in silicone a poli intrecciati.

Hängeleuchte aus mundgeblasenem Glasdiffusor, im Rotationsverfahren hergestellt, innen satiniert. Diese Fertigung macht jedes Glas einzigartig. Verchromte Metallstruktur. Silikonkabel gewebt.

Lampe à suspension avec un diffuseur en verre soufflé à épaisseur hors de moule, ouvré en rotation et internement sablé. Cet ouvrage artistique rend unique chaque produit. Le verre, dont la forme est irrégulière, est fixé à des détails en métal chromé. Alimentation avec câble en silicone à pôles tressés.

Lámpara colgante con difusor de vidrio soplado hasta espesor fuera del molde, trabajado en rotación y arenado en su interior. Esta elaboración artística hace que cada pieza sea única. El vidrio de forma irregular está fijado a soportes de metal cromado. Alimentación con cable de silicona de polos entrelazados.

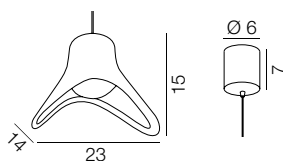

## colours



transparent

## finishing

gloss

## dimensions

L 23 - H 15 - W 14 cm

## canopy

chromed

Ø 6 - H 7 cm

## bulbs



halogen  1x33W G9 clear

led  1x2,5W G9

## feeding

220-240 / 120 V

## certifications

  IP20

energy efficiency class A+, D





# FLOOR ceiling

KARIM RASHID / 2007





# FLOOB ceiling

KARIM RASHID / 2007

Suspension downlighter in thermoformed and extruded Plexiglas with spun and laser cut aluminium reflector and integrated acid etched glass diffuser.

Lampada a sospensione a luce diretta in Plexiglas termoformato ed estruso con riflettore in alluminio tornito e tagliato al laser e diffusore in vetro acidato.

Hängeleuchte mit direktem Licht aus thermogeformtem und extrudiertem Plexiglas. Reflektor aus lasergeschnittenem Aluminium mit geätztem Glasdiffuser.

Lampe à suspension avec lumière direct en Plexiglas thermoformé et extrudé. Réflecteur en aluminium repoussé et coupé laser avec diffuseur en verre acidé.

Lámpara colgante de luz directa de Plexiglás termoformado y extruido con reflector de aluminio torneado y cortado con láser y difusor de vidrio acidado.

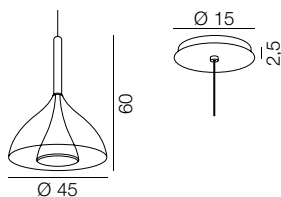

## colours



transparent orange fuchsia

## finishing

gloss

## dimensions

Ø 45 - H 60 cm

## canopy

white or orange or fuchsia  
Ø 15 - H 2,5 cm

## bulbs

halogen

fluo ◀ 1x23W E27 (E26US) PAR38

led ◀ 1x14W E27 (E26US) PAR38

## feeding

220-240 / 120 V

## certifications

Ⓢ CE IP20

energy efficiency class from A+ to E





# SHAKTI SKY

MARZIO RUSCONI CLERICI / 2003







# SHAKTI SKY

MARZIO RUSCONI CLERICI / 2003

Suspension lamp with diffusers in laser cut Plexiglas, inserted in a polished steel ring.

Lampada a sospensione con diffusori in Plexiglas tagliati a laser, inseriti in un anello in acciaio a specchio.

Pendelleuchte mit zwei lasergeschnittenen Plexiglas-diffusoren, die an einem polierten Edelstahlring befestigt werden.

Lampe à suspension avec des diffuseurs en Plexiglas coupés laser, introduits dans un corps central en acier à miroir.

Lámpara colgante con difusores de Plexiglas cortados con láser, introducidos en un anillo de acero acabado a espejo.

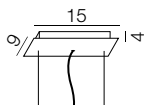
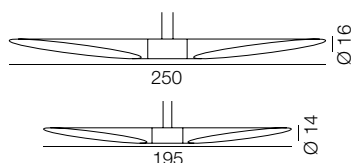

## colours



white

orange

red

fuchsia

## finishing

gloss

## dimensions

shakti sky 200      Ø 14 - H 195 cm  
shakti sky 250      Ø 16 - H 250 cm

## canopy

chromed

L 15 - W 9 - H 4 cm

## bulbs

shakti sky 200 / 250

fluo      ◀ 2x23W E27 (E26US) PAR38

led      ◀ 2x14W E27 (E26US) PAR38

## feeding

220-240 / 120 V

## certifications

Ⓢ CE IP20

energy efficiency class from A+ to E



# NOGLOBE ceiling

LAURA AGNOLETTO | MARZIO RUSCONI CLERICI / 2004









# NOGLOBE<sub>ceiling</sub>

LAURA AGNOLETTO | MARZIO RUSCONI CLERICI / 2004

Suspension lamp, made of a white acrylic sphere with three elliptic laser cut holes and chromed spun steel structure.

Lampada a sospensione, costituita da una sfera in acrilico bianco con tre fori ellissoidali tagliati a laser e struttura in acciaio tornito e cromato.

Hängeleuchte, die aus einer weißen Plexiglassphäre mit drei elliptischen Laserausschnitten besteht, montiert auf eine verchromte Stahlstruktur.

Lampe à suspension constituée par une sphère en acrylique blanc avec trois ronds à la forme d'une ellipse coupée laser et structure en acier repoussé et chromé.

Lámpara colgante, constituida por una esfera de acrílico blanco con tres orificios elipsoidales cortados con láser y estructura de acero torneado y cromado.

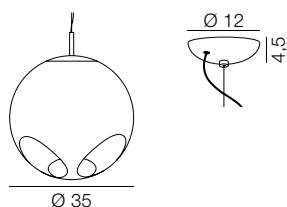

## colours



white

## finishing

gloss

## dimensions

Ø 35 cm

## canopy

chromed

Ø 12 - H 4,5 cm

## bulbs

fluo ◐ 1x21W E27 (E26US) globo Ø102mm

led ◐ 1x4W E27 (E26US) globo Ø102mm

## feeding

220-240 / 120 V

## certifications

Ⓢ CE IP20

energy efficiency class from A+ to E



# TORIC ceiling

PATRICK NORGUET / 2003





# TORIC ceiling

PATRICK NORGUET / 2003

Suspension lamp with direct light. Structure in white painted metal. Reflector in black/white or orange/white painted metal. Glass diffuser.

Lampada a sospensione a luce diretta. Struttura in metallo verniciato bianco. Riflettore in metallo verniciato bianco/arancio o bianco/nero. Diffusore in vetro.

Hängeleuchte mit direktem Licht. Weiss lackierte Metallstruktur. Reflektor in weiss-orangem oder weiss-schwarzem Metall. Glasdiffusor.

Lampe à suspension avec lumière directe. Structure en métal verni blanc. Réflecteur en métal verni blanc/orange ou blanc/noir. Diffuseur en verre.

Lámpara colgante de luz directa. Estructura de metal barnizada blanco. Reflector de metal barnizado blanco/naranja o blanco/negro. Difusor de vidrio.

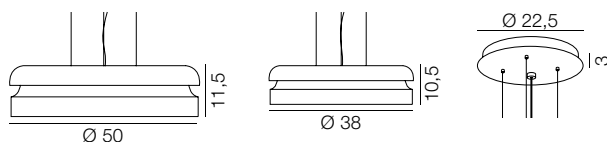

## colours



white / orange  
RAL9010 / RAL2009

white / black  
RAL9010 / RAL9011

## finishing

gloss powder coated

## dimensions

toric L                    Ø 50 - H 11,5 cm  
toric S                    Ø 38 - H 10,5 cm

## canopy

white  
Ø 22,5 - H 3 cm

## bulbs



fluo     4x12W E14 (E12US)

led      4x6W E14 (E12US)

## feeding

220-240 / 120 V

## certifications

   IP20

energy efficiency class from A+ to E





# SAMA ceiling

GREGORIO SPINI / 2004





# SAMA ceiling

GREGORIO SPINI / 2004

Ceiling spot light with a two tone co-extruded laser cut Plexiglas diffuser.

Lampada a sospensione a luce direzionale con diffusore in Plexiglas bicolore coestruso tagliato a laser.

Hängeleuchte mit Spotlicht aus einem zweifarbig coextrudierten, lasergeschnittenen Plexiglasdiffusor.

Lampe à suspension à lumière directionnelle avec un diffuseur en Plexiglas bicolore co-extrudé coupé laser.

Lámpara colgante de luz direccional con difusor de Plexiglás bicolor co-extruido cortado con láser.

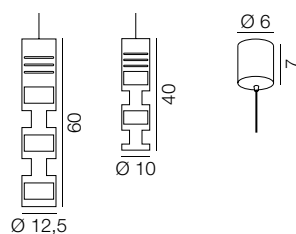

## colours



## finishing

gloss

## dimensions

sama M                    Ø 12,5 - H 60 cm  
sama S                    Ø 10 - H 40 cm

## canopy

white  
Ø 6 - H 7 cm

## bulbs

halogen 1x50W GZ10

## feeding

220-240 / 120 V

## certifications

Ⓢ CE IP20  
energy efficiency class D





# PIPE

JEAN MARIE MASSAUD / 2001





# PIPE

JEAN MARIE MASSAUD / 2001

Suspension lamp, structure in anodized aluminium. Diffuser in transparent glass with perforated aluminium screen.

Lampada a sospensione, struttura in alluminio anodizzato. Diffusore in vetro trasparente e schermo in alluminio microforato brillantato.

Hängeleuchte, eloxierte Aluminiumstruktur. Diffusor in durchsichtigem Glas mit fein durchlöcherter Aluminiumschirm.

Lampe à suspension, structure en aluminium anodisé. Diffuseur en verre transparent avec écran en aluminium micropercé.

Lámpara colgante, estructura de aluminio anodizado. Difusor de vidrio transparente y pantalla de aluminio microperforado en brillo.

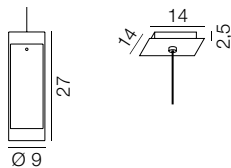

## colours



transparent

## finishing

gloss

## dimensions

Ø 9 - H 27 cm

## canopy

chromed

L 14 - W 14 - H 2,5 cm

## bulbs

halogen  1x42W E14 (E12US) clear



fluo  1x12W E14 (E12US)

led  1x6W E14 (E12US)

## feeding

220-240 / 120 V

## certifications

   IP20

energy efficiency class from A+ to E





# E.T.A. SAT

GUGLIELMO BERCHICCI / 1997







# E.T.A. SAT

GUGLIELMO BERCHICCI / 1997

Suspension lamp. Handmade light diffuser in ecological fibreglass, with polycarbonate reflector, metallic inner structure.

Lampada a sospensione. Corpo diffusore in vetroresina ecologica fatto a mano, con riflettore in policarbonato, struttura interna in metallo.

Hängeleuchte. Handgemachter Diffusor aus ökologischem Fiberglas, mit Polykarbonatreflektor, interne metallene Leuchtmittelhalterung.

Lampe à suspension. Diffuseur en fibre de verre écologique fait à la main, avec réflecteur en polycarbonate, structure intérieure en métal.

Lámpara colgante. Cuerpo difusor de resina de vidrio ecológica trabajado a mano, reflector de policarbonato, estructura interna de metal.

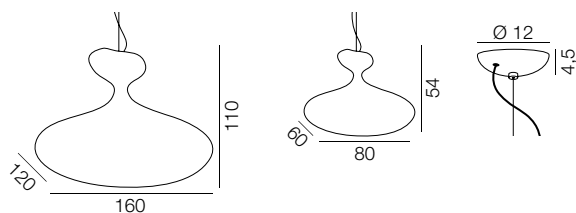

## colours



white

orange

red

silver

## finishing

coloured fibreglass

## dimensions

e.t.a. sat giant L 160 - W 120 - H 110 cm

e.t.a. sat L 80 - W 60 - H 54 cm

## canopy

white

Ø 12 - H 4,5 cm

## bulbs

e.t.a. sat giant

halogen

fluo  6x21W E27 (E26US) +

 2x16W E27 (E26US)

led  8x16W E27 (E26US)

e.t.a. sat

halogen  1x42W E14 (E12US) clear round +

 1x120W E27 (E26US) clear tubular

fluo  1x9W E14 (E12US) round +

 1x30W E27 (E26US)



led  1x6W E14 (E12US) +

 1x16W E27 (E26US)

## feeding

220-240 / 120 V

## certifications

  IP20

energy efficiency class from A+ to E



# TRIPOD ceiling

CHRISTOPHE PILLET / 2002







# TRIPOD ceiling

CHRISTOPHE PILLET / 2002

Suspension lamp, structure in grey or white painted metal. Shade in fire resistant fabric closed by a painted perforated metal disc.

Lampada a sospensione, struttura in metallo verniciato grigio o bianco. Paralume in tessuto ignifugo chiuso da un disco in metallo microforato e verniciato.

Hängeleuchte, grau oder weiss lackierte Metallstruktur. Diffusor aus feuerfestem Stoff, von durchlöcherter eloxierter Aluminiumscheibe verschlossen.

Lampe à suspension, structure en métal verni gris ou blanc. Diffuseur en tissu ignifuge fermé par un disc en métal micropercé verni.

Lámpara colgante, estructura de metal barnizado gris o blanco. Pantalla de tejido ignifugo fijada con disco de metal microperforado y barnizado.

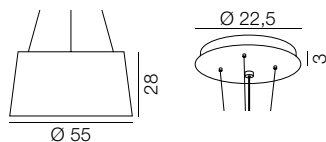

## colours



white

ecrú

moka

## finishing

fabric

## dimensions

Ø 55 - H 28 cm

## canopy

white or grey

Ø 22,5 - H 3 cm

## bulbs

halogen  3x70W E27 (E26US) clear tubular



fluo  3x21W E27 (E26US)

led  3x16W E27 (E26US)

## feeding

220-240 / 120 V

## certifications

   IP20

energy efficiency class from A+ to E



# NEW YORK<sub>wall</sub>

PETER JAMIESON / 2015





# NEW YORK<sub>wall</sub>

PETER JAMIESON / 2015

Wall lamp with multilayered technopolymer reflector and methacrylate diffuser. Structure in white painted metal.

Lampada da parete con riflettore in tecnopolimero multistrato e diffusore in metacrilato. Struttura in metallo verniciato bianco.

Wandleuchte mit Reflektor aus mehrschichtigem Technopolymer und Diffusor in Metakrylat. weiss lackierte Metallstruktur.

Applique avec un réflecteur en technopolymère multicouches et un diffuseur en méthacrylate. Structure en métal verni blanc.

Lámpara de pared con reflector en multiestrato de tecnopolímero y difusor en metacrilato. Estructura de metal barnizado blanco.

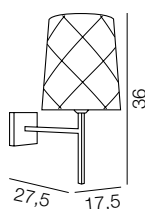

## colours





**finishing**  
gloss

## dimensions

L 17,5 - W 27,5 - H 36 cm



## bulbs

fluo  1xmax30W E27 (E26 US) or  
led  1x16W E27 (E26 US)

## feeding

220-240 / 120 V

## certifications

  IP20  
energy efficiency class from A+ to E





# DAWN

MARCO MERENDI / 2014





# DAWN

MARCO MERENDI / 2014

Wall and ceiling lamp. Matt white painted reflector and polished copper or black chrome luminaire body. Dawn 105 with RGBA LED light source that allows the production of a wide range of colours and all shades of white light.

Lampada da parete e soffitto. Riflettore verniciato bianco opaco e corpo illuminante in rame lucido o cromo nero. Dawn 105 con sorgente luminosa a led RGBA che consente di produrre un'ampia gamma di colori e tutte le tonalità di luce bianca.

Wandleuchte. Mattweiß lackierter Reflektor und Leuchtkörper aus glänzendem Kupfer oder schwarzem Chrom. Dawn 105 mit LED-Leuchtquelle (RGBA), die Licht in einer großen Anzahl Farben sowie allen Weißtönen erzeugt.

Applique et plafonnier. Réflecteur peint blanc opaque et corps d'éclairage en cuivre brillant et chrome noir. Dawn 105 avec source lumineuse à led RGBA qui permet de produire une vaste gamme de couleurs et toutes les tonalités de lumière blanche.

Lámpara de pared y de techo. Reflector barnizado blanco opaco y cuerpo de alumbrado de cobre pulido o cromo negro. Dawn 105 con fuente luminosa de led RGBA que permite producir una amplia gama de colores y todas las tonalidades de luz blanca.

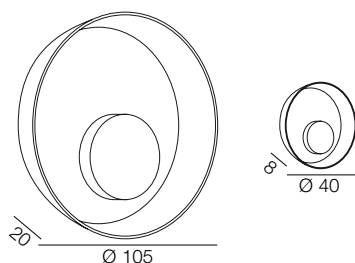

## colours



white RAL9010 +  
polished copper



white RAL9010 +  
black chrome

## finishing

matt + polished copper or black chrome

## dimensions

dawn 105      Ø 105 - W 20 cm  
dawn 40        Ø 40 - W 8 cm

## bulbs

dawn 105  
board led 12x10W RGBA  
dawn 40  
board led 1x17W - 2700K - 1600lm - CRI>80

## feeding

220-240 / 120 V

## certifications

Ⓢ CE IP20  
energy efficiency class A+



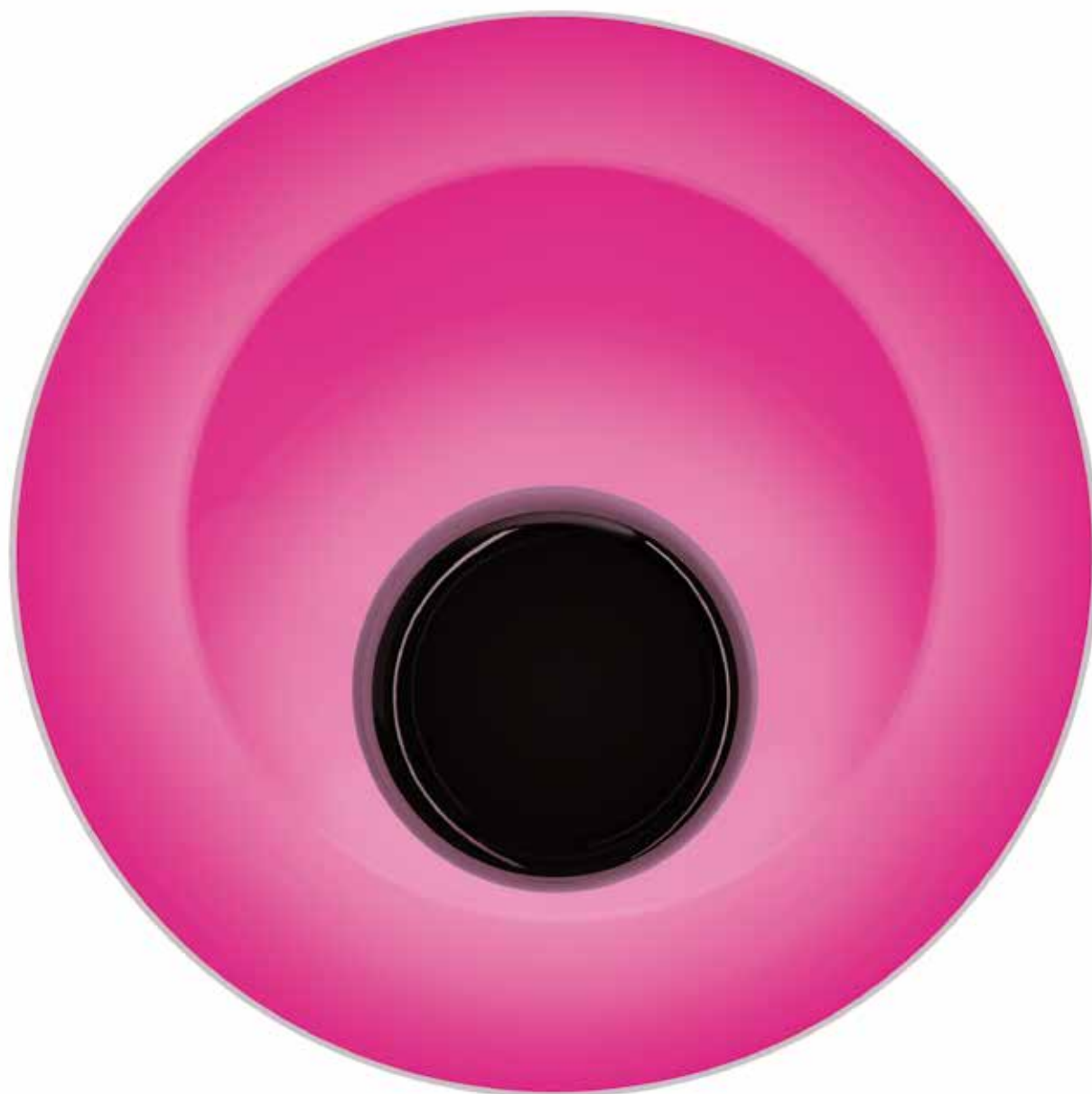



TUA

BEHURT / 2014





# TUA

BEHURT / 2014

Wall lamp. Metal frame with black tin finishing or gloss liquid varnished, and frosted glass diffusers.

Lampada da parete. Corpo in metallo con finitura in stagno nero o verniciatura a liquido lucida, diffusori in vetro acidato.

Wandleuchte. Körper aus Metall mit Oberfläche aus schwarzem Zinn oder Flüssigbeschichtung, Diffusoren aus geätztem Glas.

Applique. Corps en métal avec finition en étain noir ou laqué liquide brillant, diffuseurs en verre poli.

Aplique. Cuerpo de metal con acabado en estaño negro o barnizado liquido brillo, difusores de vidrio acidado.

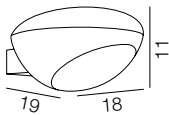

## colours

---



black tin

white  
RAL9010

## finishing

---

gloss + frosted glass

## dimensions

---

L 18 - W 19 - H 11 cm

## bulbs

board led 1x17W - 2700K - 1600lm - CRI>80

## feeding

---

220-240 / 120 V

## certifications

---

⊕ CE IP20

energy efficiency class A+



# KINOKO

DE-SIGNUM - L.LONGO & A.ROMANO / 2013







# KINOKO

DE-SIGNUM - L.LONGO & A.ROMANO / 2013

Wall lamp with die-casted heat sink, transparent polycarbonate screen, cold wrought steel and powder coated body.

Lampada da parete con dissipatore in alluminio pressofuso, schermo in policarbonato trasparente e corpo in acciaio lavorato a freddo e verniciato a polvere.

Wandleuchte mit Kühlkörper aus Aluminiumdruckguss mit Schirm in transparentem Polykarbonat und Körper aus Stahl kühl verarbeitet und Pulverlackiert.

Applique avec dissipateur en aluminium moulé, écran en polycarbonate transparent et corps en acier forgé à froid verni à poudre.

Lámpara de pared con disipador de aluminio vaciado a presión, pantalla y policarbonato transparente y cuerpo en acero elaborado en frío y barnizado a polvo.

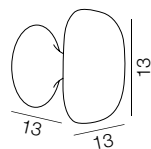

## colours



white  
RAL9010

black  
RAL9004

red  
RAL3013

## finishing

gloss powder coated

## dimensions

L 13 - W 13 - H 13 cm

## bulbs

board led 1x8,7W - 3000K - 400lm - CRI>80

## feeding

220-240 / 120 V

## certifications

Ⓢ CE IP20

energy efficiency class A+



A photograph of a room with dark wood paneling and a shelf of books. The text 'FRAME' is overlaid in the top left corner. The room features dark wood paneling on the walls and a shelf with several books. The lighting is warm and focused on the central area.

# FRAME

BENJAMIN HUBERT / 2011



*Tout Passe, Tout Cas*

*Tout Lasse, Tout Se*

*Remplace.....*



# FRAME

BENJAMIN HUBERT / 2011

Wall lamp. Die-casted matt varnished or chromed aluminium diffuser. Led version available.

Lampada da parete. Corpo in alluminio pressofuso verniciato opaco o cromato. Disponibile nella versione a led.

Wandleuchte. Körper aus Aluminiumdruckguss, matt lackiert oder verchromt. Version aus led verfügbar.

Applique. Corps en aluminium moulée vernis mat ou aluminium chromé. Version disponible led.

Aplique. Estructura en aluminio de fundición barnizado mate o cromado. Disponible en la versión de led.

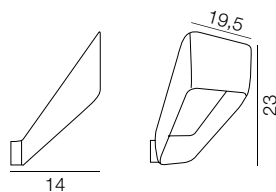

## colours



white  
RAL9010

chrome

## finishing

matt powder coated or chromed

## dimensions

L 19,5 - W 14 - H 23 cm

## bulbs

frame  
halogen → 1xmax150W R7S 78 mm  
frame led  
board led 1x25W - 2700K - 2500lm - CRI>80

## feeding

220-240 / 120 V

## certifications

Ⓢ CE IP20

frame energy efficiency class C  
frame led energy efficiency class A+



# EVITA<sub>wall</sub>

AQUILIALBERG / 2011





# EVITA<sub>wall</sub>

AQUILIALBERG / 2011

Wall lamp. Technopolymer and rotational-moulded polyethylene diffuser and structure.

Lampada da parete. Struttura e diffusore in tecnopolimeri e polietilene stampato in rotazionale.

Wandleuchte. Konstruktion und Diffusor aus Technopolymeren und im Rotationsverfahren gepresstem Polyethylen.

Applique. Structure et diffuseur en technopolymères et polyéthylène moulé en rotation.

Aplique. Estructura y difusor en tecnopolímeros y polietileno estampado en rotacional.

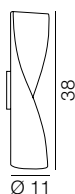

## colours



warm white  
RAL1013



beige  
RAL1001

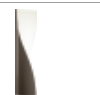

dove-grey  
RAL7006



red  
RAL3003

## finishing

gloss

## dimensions

Ø 11 - H 38 cm

## bulbs

board led 1x18W - 2700K - 2000lm - CRI>80

## feeding

220-240 / 120 V

## certifications

⊕ CE IP20

energy efficiency class A+





# PIXEL

BAKERY GROUP / 2009



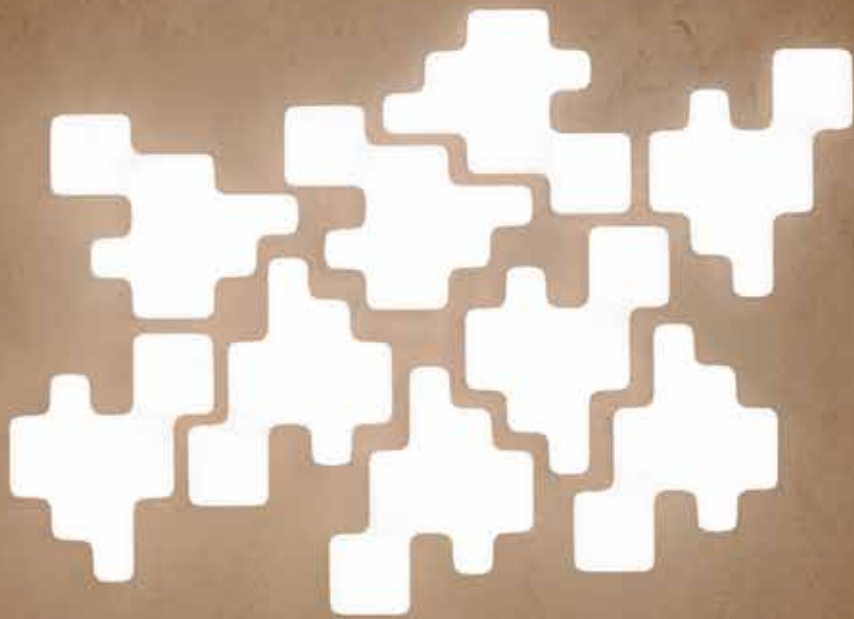

# PIXEL

BAKERY GROUP / 2009

Wall and ceiling lamp. Rotational-moulded polyethylene diffuser fixed to a varnished metal structure.

Lampada da parete e da soffitto. Diffusore in polietilene stampato in rotazionale, fissato a struttura portante in metallo verniciato.

Wand- und Deckenleuchte. Polyethylendiffusor im Rotationsverfahren hergestellt auf einer versteckten Metallhalterung montiert.

Applique et plafonnier composée d'un diffuseur en polyéthylène imprimé en rotomoulage et d'une structure portante en metal verni.

Lámpara de pared y de techo. Difusor de polietileno estampado en rotacional, fijado a una estructura portante de metal barnizado.

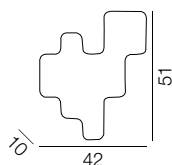

## colours



white

## finishing

gloss

## dimensions

L 42 - W 10 - H 51 cm

## bulbs



fluo  3x12W E14 (E12US)

led  3x6W E14 (E12US)

## feeding

220-240 / 120 V

## certifications

  IP20

energy efficiency class from A+ to E





# ATOMIUM<sub>wall</sub>

HOPF&WORTMANN - BÜRO FÜR FORM / 2006





# ATOMIUM<sub>wall</sub>

HOPF&WORTMANN - BÜRO FÜR FORM / 2006

Wall and ceiling lamp with rotational-moulded polyethylene diffuser and inner structure with three light sources fixed on steel coil springs assembled on a laser-shaped coated base.

Lampada da parete e da soffitto con diffusore in polietilene stampato in rotazionale con struttura interna a tre luci montate su molle tensionate in acciaio, fissate su basamento sagomato a laser e verniciato.

Wandleuchte mit Polyethylen-Diffusor im Rotationsverfahren hergestellt, innen Stahl-Federstruktur mit drei Leuchtmittel, montiert auf Metallbasis.

Applique et plafonnier avec un diffuseur en polyéthylène imprimé en rotoroulage et une structure intérieure à trois luminaires placées sur des ressorts tensionnés en acier.

Lámpara de pared y de techo con difusor de polietileno estampado en rotacional con estructura interna de tres luces montadas sobre resortes tensados de acero, fijadas sobre una base perfilada con láser y barnizada.

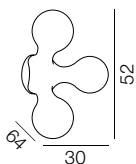

## colours



white



## finishing

gloss

## dimensions

L 64 - W 30 - H 52 cm



## bulbs

halogen  3x40W E14 (E12US) clear  
fluo  3x12W E14 (E12US)  
led  3x6W E14 (E12US)

## feeding

220-240 / 120 V

## certifications

   IP20  
energy efficiency class from A+ to E



# DROP

FUTURE SYSTEMS / 2006







# DROP

FUTURE SYSTEMS / 2006

Wall and ceiling lamp with triplex opal glass diffuser, mouth blown and acid etched, fixed on a coated spun base.

Lampada da parete e da soffitto con diffusore in vetro opale incamiciato, soffiato e acidato, montato su fondello tornito e verniciato.

Wand-und Deckenleuchte mit mundeblasenem und geätztem Triplexglasdiffusor, und lackierter Metallstruktur.

Applique et plafonnier avec un diffuseur en verre opalin, acidé et soufflé triplex, monté sur une base repoussée et vernie.

Lámpara de pared y de techo con difusor de vidrio ópalo enfundado, soplado y acidado, montado sobre base torneada y barnizada.

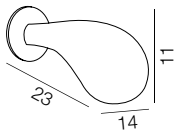

## colours



white

## finishing

acid etched glass

## dimensions

L 14 - W 23 - H 11 cm

## bulbs



halogen  1x48W G9 clear

led  1x2,5W G9

## feeding

220-240 / 120 V

## certifications

  IP20

energy efficiency class A+, D



# ALONE

GIORGIO GURIOLI / 2006









# ALONE

GIORGIO GURIOLI / 2006

Wall and ceiling lamp with thermoformed diffuser in satin opal Plexiglas, fixed on two laser-cut and coated metal plates.

Lampada da parete e da soffitto con diffusore termoformato in plexiglas opale satinato, montato su doppia lastra di metallo tagliato al laser e verniciato.

Wand-und Deckenleuchte aus thermogeformtem, opalmattem Plexiglasdiffusor, montiert auf zwei lackierte Metallplatten.

Applique et plafonnier avec un diffuseur thermoformé en Plexiglas opalin satiné, monté sur une double plaque en métal coupé laser et vernis.

Lámpara de pared y de techo con difusor termoformado de plexiglás ópalo satinado, montado sobre una doble plancha de metal, cortado al láser y barnizado.

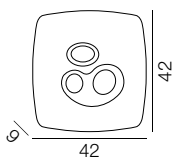

## colours



white

## finishing

satin opal

## dimensions

L 42 - W 9 - H 42 cm



## bulbs

fluo  1x40W T5c

## feeding

220-240 / 120 V

## certifications

  IP20  
energy efficiency class A+



# SHAKTI<sub>wall</sub>

MARZIO RUSCONI CLERICI / 2002





# SHAKTI<sub>wall</sub>

MARZIO RUSCONI CLERICI / 2002

Double light wall lamp with tubular light diffuser in laser cut Plexiglas. Available for direct wall mounting or with cable, plug and dimmer.

Lampada a parete a due luci con diffusore tubolare in Plexiglas tagliato a laser. Shakti Wall è disponibile nella versione per punto luce o nella versione con spina e dimmer.

Wandleuchte mit doppelter Lichtquelle in einem lasergeschnittenen Plexiglasdiffusor. Lieferbar in der Version für elektrischer Wandanschluss, oder verkabelt mit Stecker.

Applique à deux lumières avec le diffuseur tubulaire en Plexiglas coupé laser. Shakti Wall est disponible dans la version traditionnelle et en la version avec une fiche et un gradateur de lumière.

Lámpara de pared con dos luces con difusor tubular de Plexiglás cortado con láser. Shakti Wall está disponible en la versión para punto luz o en la versión con enchufe y dimmer.

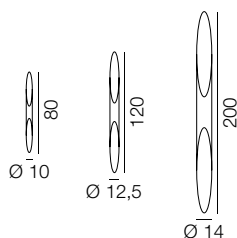

## colours

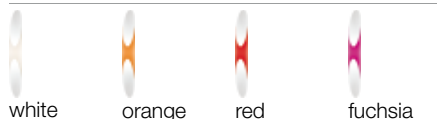



## finishing



gloss



## dimensions

|                     |                   |
|---------------------|-------------------|
| shakti wall fix 80  | Ø 10 - H 80 cm    |
| shakti wall fix 120 | Ø 12,5 - H 120 cm |
| shakti wall fix 200 | Ø 14 - H 200 cm   |

## bulbs

shakti wall fix 80  
halogen  1x42W E27 (E26US) clear round  
fluo  1x7W E27 (E26US)  
led  1x16W E27 (E26US)



shakti wall fix 120  
halogen  1x70W E27 (E26US) clear tubular  
fluo  1x11W E27 (E26US)  
led  1x16W E27 (E26US)

shakti wall fix 200  
halogen  2x70W E27 (E26US) clear tubular  
fluo  2x21W E27 (E26US)  
led  2x16W E27 (E26US)

## feeding

220-240 / 120 V

## certifications

   IP20

energy efficiency class from A+ to E



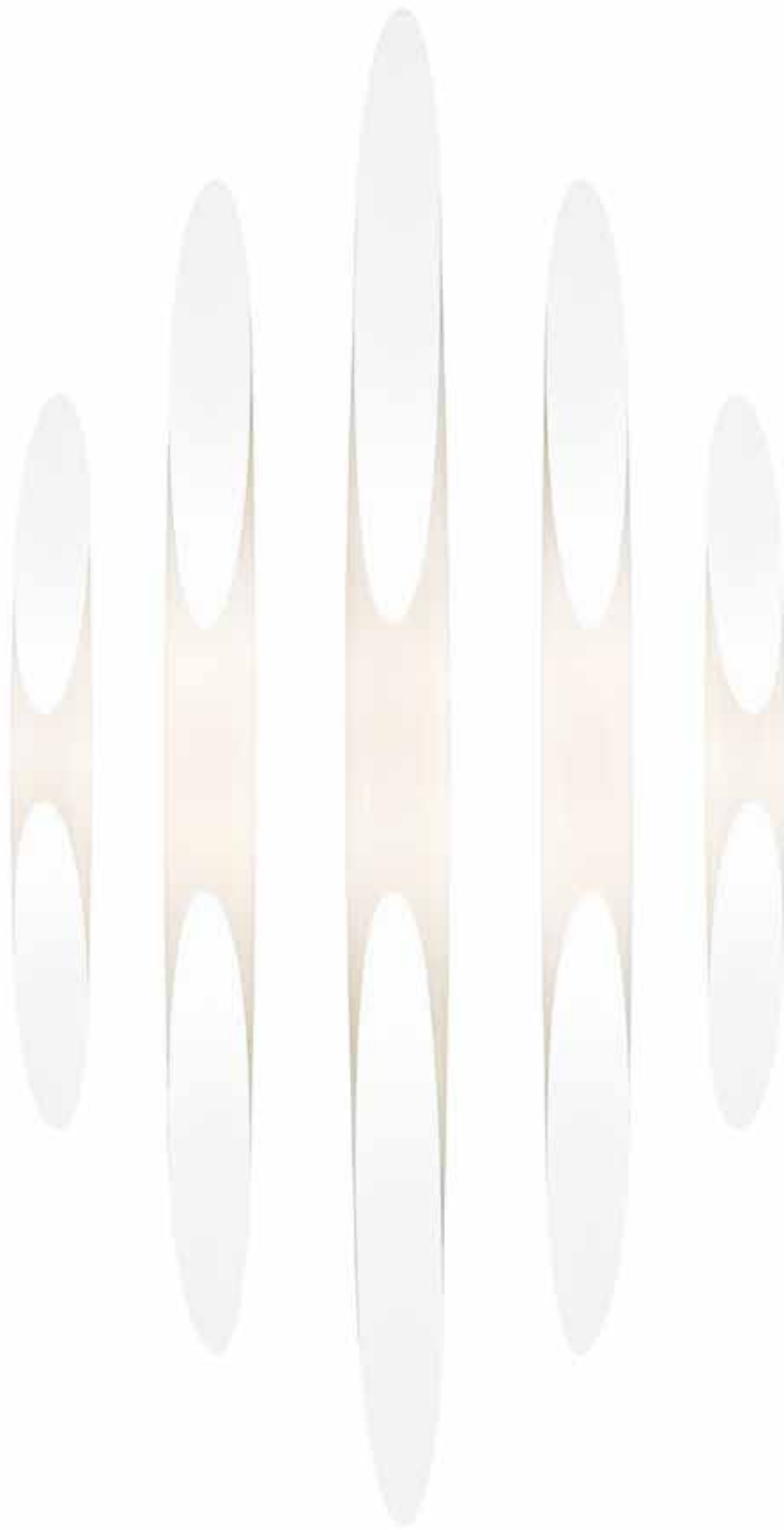

# FLAP

JEAN MARIE MASSAUD / 2000







# FLAP

JEAN MARIE MASSAUD / 2000

Adjustable wall lamp indirect light, structure in white painted metal. White or grey metal reflector.

Lampada da parete orientabile a luce indiretta, struttura in metallo verniciato bianco. Riflettore in metallo verniciato grigio o bianco.

Regulierbare Wandleuchte mit indirektem Licht, weiss lackierte Metallstruktur. Reflektor aus grau oder weiss lackiertem Metall.

Applique réglable avec lumière indirect, structure en métal verni blanc. Réflecteur en métal verni gris ou blanc.

Lámpara de pared orientable de luz indirecta, estructura de metal barnizado blanco. Reflector de metal barnizado gris o blanco.

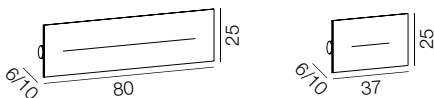

## colours



white

grey

## finishing

gloss powder coated

## dimensions

flap L L 80 - W 6/10 - H 25 cm  
flap S L 37 - W 6/10 - H 25 cm

## bulbs

flap L

fluo  1x80W 2G11

flap S



fluo  1x30W E27 (E26US)

led  1x16W E27 (E26US)

## feeding

220-240 / 120 V

## certifications

  IP20

flap L energy efficiency class A

flap S energy efficiency class from A+ to E





# MANDALA

ALESSANDRO MENDINI / 2006





# MANDALA

ALESSANDRO MENDINI / 2006

Wall and ceiling lamp with curved plated glass diffuser pressed with "fracco" and hand-decorated. Spun and chrome-plated metal frame fixed on a coated box structure.

Lampada da parete e da soffitto con diffusore in vetro in piastra curvato, lavorato al fracco e decorato a mano. Sostegni in metallo tornito e cromato fissati su struttura inscatolata verniciata.

Wand- und Deckenleuchte aus gegossenem, auf "fracco" gedrucktem Glas, handbemalt. Sichtbare Befestigungen aus verchromtem Metall.

Applique et plafonnier avec un diffuseur en verre coulé et courbé, imprimé au "fracco" et décoré à la main. Soutiens en métal repoussé et chromé montés sur une structure à boîte vernie.

Lámpara de pared y de techo con difusor de vidrio en plancha curvado, trabajado con un especial aparato artesanal (fracco) y decorado a mano. Soportes de metal torneado y cromado, fijados sobre una estructura en caja barnizada.

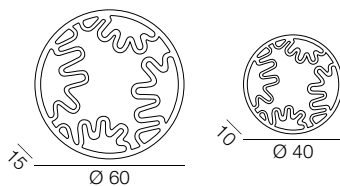

## colours



coloured

silver

## finishing

gloss

## dimensions

mandala L      Ø 60 - W 15 cm  
mandala S      Ø 40 - W 10 cm

## bulbs

halogen ↔ 2x120W R7S 118mm

## feeding

220-240 / 120 V

## certifications

⊕ CE IP20

energy efficiency class D





# MANDALA

KARIM RASHID / 2006







# MANDALA

KARIM RASHID / 2006

Wall and ceiling lamp with curved plated glass diffuser pressed with "fracco" and hand-decorated. Spun and chrome-plated metal frame fixed on a coated box structure.

Lampada da parete e da soffitto con diffusore in vetro in piastra curvato, lavorato al fracco e decorato a mano. Sostegni in metallo tornito e cromato fissati su struttura inscatolata verniciata.

Wand- und Deckenleuchte aus gegossenem, auf "fracco" gedrucktem Glas, handbemalt. Sichtbare Befestigungen aus verchromtem Metall.

Applique et plafonnier avec un diffuseur en verre coulé et courbé, imprimé au "fracco" et décoré à la main. Soutiens en métal repoussé et chromé montés sur une structure à boîte vernie.

Lámpara de pared y de techo con difusor de vidrio en plancha, trabajado con un especial aparato artesanal (fracco) y decorado a mano. Soportes de metal torneado y cromado, fijados sobre una estructura en caja barnizada.

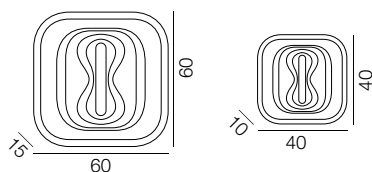

## colours



coloured

silver

## finishing

gloss

## dimensions

mandala L L 60 - W 15 - H 60 cm  
mandala S L 40 - W 10 - H 40 cm

## bulbs

halogen ↔ 2x120W R7S 118mm

## feeding

220-240 / 120 V

## certifications

⊕ CE IP20

energy efficiency class D



# PASTILLA

PATRICIA URQUIOLA / 2000







# PASTILLA

PATRICIA URQUIOLA / 2000

Wall lamp, structure in white painted metal. Diffuser in pressed acid etched glass.

Lampada da parete, struttura in metallo verniciato bianco. Diffusore in vetro pressato e acidato.

Wandleuchte, weiss lackierte Metallstruktur. Diffusor aus gepresstem und geätzttem Glas.

Applique, structure en métal verni blanc. Diffuseur en verre pressé et acidé.

Lámpara de pared, estructura de metal barnizado blanco. Difusor de vidrio prensado y acidado.

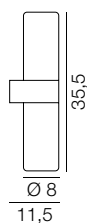

## colours



white



## finishing

acid etched glass + painted metal

## dimensions

Ø 8 - W 11,5 - H 35,5 cm



## bulbs

halogen  2x60W E14 (E12US) clear  
fluo  2x12W E14 (E12US)  
led  2x6W E14 (E12US)

## feeding

220-240 / 120 V

## certifications

  IP20

energy efficiency class from A+ to E



# PLUTO<sub>wall</sub>

PAOLA NAVONE / 2006





# PLUTO<sub>wall</sub>

PAOLA NAVONE / 2006

Wall and ceiling lamp with mouth-blown diffuser, rotationally-formed and internally sand-blasted. This artistic craftwork makes unique any and each product. This irregularly shaped glass is assembled on chrome-plated metal base.

Lampada da parete e da soffitto con diffusore in vetro soffiato, lavorato in rotazione e internamente sabbiato. Questa lavorazione artistica rende unico ogni singolo prodotto. Il vetro dalla forma irregolare è fissato a un attacco a parete in metallo cromato.

Wand- und Deckenleuchte mit mundgeblasenem Glasdiffusor im Rotationsverfahren hergestellt, innen satiniert. Diese Fertigungsschritte tragen dazu bei, dass jedes Glas einzigartig ist. Verchromte

Applique et plafonnier avec un diffuseur en verre soufflé, ouvert en rotation e internement sablé. Cet ouvrage artistique rend unique chaque produit. Le verre, dont la forme est irrégulière, est fixé à une structure chromé.

Lámpara de pared y de techo con difusor de vidrio soplado, trabajado en rotación y arenado en su interior. Esta elaboración artística hace que cada pieza sea única. El vidrio de forma irregular está fijado a soportes de metal cromado.

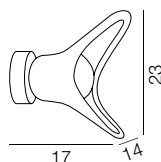

## colours



transparent

## finishing

gloss

## dimensions

L 14 - W 23 - H 15 cm

## bulbs



halogen  1x33W G9 clear

led  1x2,5W G9

## feeding

220-240 / 120 V

## certifications

  IP20

energy efficiency class A+, D





# MARKING



It certifies the conformity of the product to the European community low voltage directive.  
Attesta la conformità del prodotto alle disposizioni delle direttive comunitarie.  
Das Zeichen bestätigt die Übereinstimmung des Produkts mit den Bestimmungen der EU-Richtlinien.  
Il atteste la conformité du produit aux dispositions des directives communautaires.  
Esta certifica si el producto es conforme a las disposiciones de las normas de la comunidad.



U.S.A. and Canada conformity seal.  
Marchio di conformità U.S.A. e Canada.  
Konformitätszeichen U.S.A. und Canada.  
Conforme à la norme U.S.A. et Canada.  
Marca de conformidad U.S.A. y Canada.

IP20

Device protected against the penetration of solid objects greater than 12mm.  
Apparecchio protetto contro la penetrazione di corpi solidi di dimensioni maggiori a 12mm.  
Gegen das Eindringen von Festkörpern größer als 12mm geschützt.  
Protégé contre la pénétration des corps solides aux dimensions supérieures à 12mm.  
Protección contra la penetración de cuerpos sólidos de un tamaño superior a 12mm.

IP65

Device dust-tight and protected against water jets.  
Apparecchio totalmente protetto contro la polvere e protetto contro i getti d'acqua.  
Gerät mit absolutem Schutz gegen das Eindringen von Staub und geschützt gegen Druckwasser.  
Appareil totalement protégé contre la poussière et les projections d'eau.  
Aparato totalmente protegido contra el polvo y los chorros de agua.



Class I luminaire: it's necessary to connect the device to the yellow/green protective conductor (earthing).  
Apparecchio in Classe I: è obbligatoria la connessione al conduttore di protezione giallo/verde (messa a terra).  
Schutzklasse I: alle berührbaren Metallteile sind elektrisch leitend miteinander verbunden und werden mit dem Netzschutzleiter verbunden.  
Classe I: il est obligatoire la connexion au conducteur de protection jaune/vert (mise à la terre)  
Aparato en clase I: es obligatoria la conexión al conductor de protección amarillo/verde (toma de tierra)



Class II luminaire: appliance with double insulation.  
Apparecchio in Classe II: apparecchio in doppio isolamento.  
Schutzklasse II: gerat mit doppelter isolierung.  
Classe II: appareil dote de double isolation.  
Aparato en clase II: aparato provisto de aislamiento doble.

# NOTES

Suspension lamps are supplied with 1.8 meters long cables. Different lengths can be produced on demand. The company reserves the right to change the design of the canopies and the cable length without notice.

Le lampade a sospensione sono dotate di cavi lunghi 1.8 metri. Eventuali misure diverse possono essere prodotte su richiesta. La società si riserva comunque il diritto di variare il disegno dei rosoni e la lunghezza dei cavi senza alcun preavviso.

Die Hängelampen verfügen über 1,8 m. lange Kabel. Andere Längen können auf Anfrage hergestellt werden. Das Unternehmen behält sich in jedem Falle das Recht vor, das Design der Rosetten und die Länge der Kabel ohne Vorankündigung zu ändern.

Les lampes à suspension sont équipées de câbles d'une longueur de 1.8 m. D'éventuelles autres mesures peuvent être produites sur demande. La société se réserve toutefois le droit de modifier le dessin des rosaces et la longueur des câbles sans aucun préavis.

Las bombillas de suspensión cuentan con cables de 1,8 m. Bajo petición, se pueden producir diversas medidas. De todas formas, la sociedad se reserva el derecho de cambiar el diseño de los rosetones y la longitud de los cables sin previo aviso.

Product colors can differ from what is shown in the catalogue and from batch to batch.

I colori dei prodotti possono variare rispetto a quanto rappresentato nel catalogo e da lotto a lotto.

Die Farben der Produkte können sich von den Abbildungen im Katalog unterscheiden und von einem Fertigungslos zum anderen variieren.

Les couleurs des produits peuvent varier par rapport à ce qui est présenté dans le catalogue ainsi que de lot à lot.

Los colores de los productos pueden variar respecto a la que se muestra en el catálogo y de un lote a otro.

All dimensions are in centimeters.

Tutte le misure sono espresse in centimetri.

Alle Maße sind in Zentimetern angegeben.

Toutes les mesures sont exprimées en centimètres.

Todas las medidas están expresadas en centímetros.

Bulbs are not included.

Le lampadine non sono incluse.

Die Glühbirnen sind nicht inbegriffen.

Les ampoules ne sont pas incluses.

Las bombillas no están incluidas.

**KUNDALINI SRL**

I-20090 Trezzano sul Naviglio (MI)

Viale L. da Vinci, 277

phone +39 02 3653 8950

fax +39 02 3653 8964

[www.kundalini.it](http://www.kundalini.it)

[info@kundalini.it](mailto:info@kundalini.it)

Registered office

I-20121 Milano

Viale F. Crispi, 5/A

April 2017

KUNDALINI

IS A REGISTERED

TRADEMARK

Copyright © 2017 Kundalini srl

All Rights Reserved.

Reproduction in whole or in part of texts and images  
without express written permission is prohibited.

 **KUNDALINI**





