

THE ONE

2016

THE ONE

2016

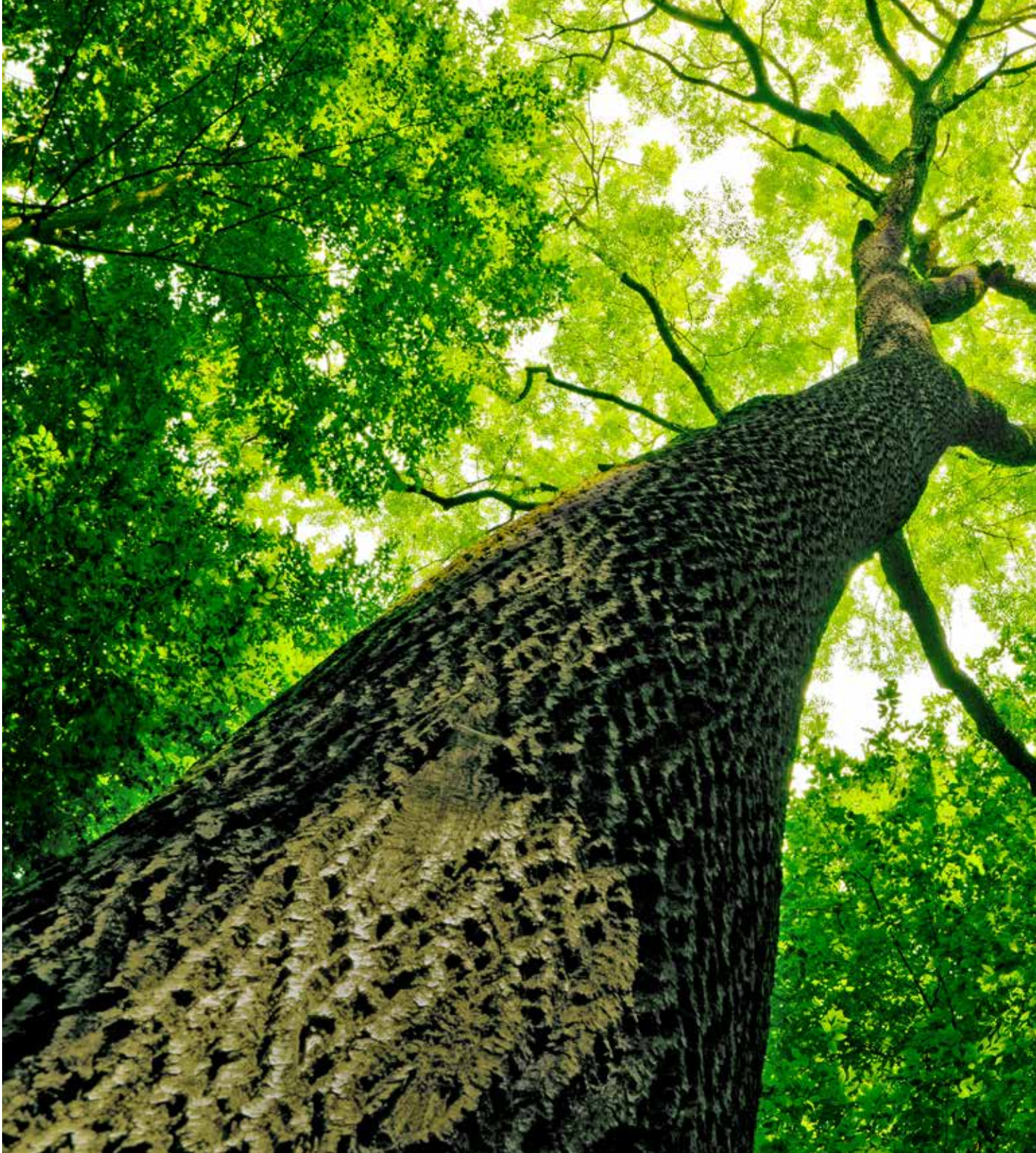

■ Nuestra historia es como la de un árbol: sólidos valores anclados en las raíces, evolución continua desde las hojas, y siempre buscando la luz.

■ Our history is similar to a tree: solid values anchored in the roots, continuous evolution from the leaves, and always searching for the light.

■ Notre histoire s'apparente à celle d'un arbre : des valeurs solidement enracinées doublées d'une croissance constante vers des feuilles verdoyantes, toujours en quête de lumière.

■ Unsere Firmengeschichte lässt sich mit einem Baum vergleichen: solide Werte bilden die Wurzeln und kontinuierliche Weiterentwicklungen sind die Blätter, die immer nach oben zum Licht streben.

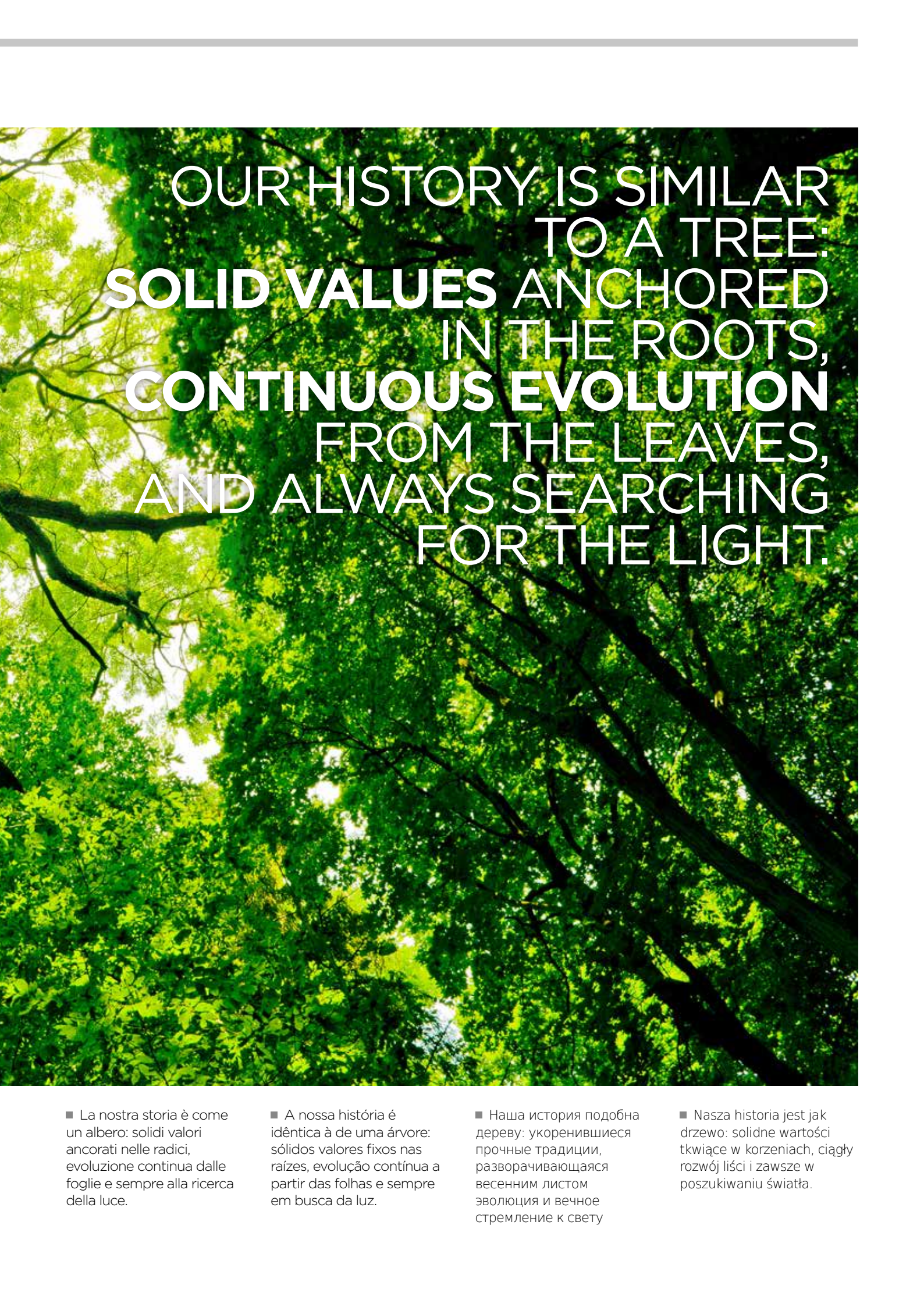

OUR HISTORY IS SIMILAR
TO A TREE:
SOLID VALUES ANCHORED
IN THE ROOTS,
CONTINUOUS EVOLUTION
FROM THE LEAVES,
AND ALWAYS SEARCHING
FOR THE LIGHT.

■ La nostra storia è come un albero: solidi valori ancorati nelle radici, evoluzione continua dalle foglie e sempre alla ricerca della luce.

■ A nossa história é idêntica à de uma árvore: sólidos valores fixos nas raízes, evolução contínua a partir das folhas e sempre em busca da luz.

■ Наша история подобна дереву: укоренившиеся прочные традиции, разворачивающаяся весенним листом эволюция и вечное стремление к свету

■ Nasza historia jest jak drzewo: solidne wartości tkwiące w korzeniach, ciągły rozwój liści i zawsze w poszukiwaniu światła.

EXPERTISE



KNOW-HOW

IN-HOUSE

DESIGN &

ENGINEERING &

TESTING &

MANUFACTURING



LEDS-C4 360°

DESCUBRE MÁS EN ESTE VIDEO
FIND OUT MORE IN THIS VIDEO
DÉCOUVREZ-EN PLUS DANS CETTE VIDÉO
MEHR IN DIESEM VIDEO
SCOPRINE DI PIÙ IN QUESTO VIDEO
DESCUBRA MAIS NESTE VIDEO
УЗНАЙТЕ БОЛЬШЕ ИЗ ЭТОГО ВИДЕО
ODKRYJ WIĘCEJ NA TYM FILMIE WIDEO

FAST DELIVERY



- 95% de los pedidos expedidos en menos de 24 horas.
- 95% of orders dispatched in less than 24 hours.
- 95% des commandes expédiées en moins de 24 heures.
- 95% der Bestellungen werden innerhalb von 24 Stunden versandt.
- 95% degli ordini spediti in meno di 24 ore.
- 95% dos pedidos expedidos em menos de 24 horas.
- 95% заказов доставляется менее, чем за 24 часа.
- 95% zamówień wysłanych w mniej niż 24 godz.

CUSTOMER-FOCUSED

USER-FRIENDLY

EASY DOWNLOAD

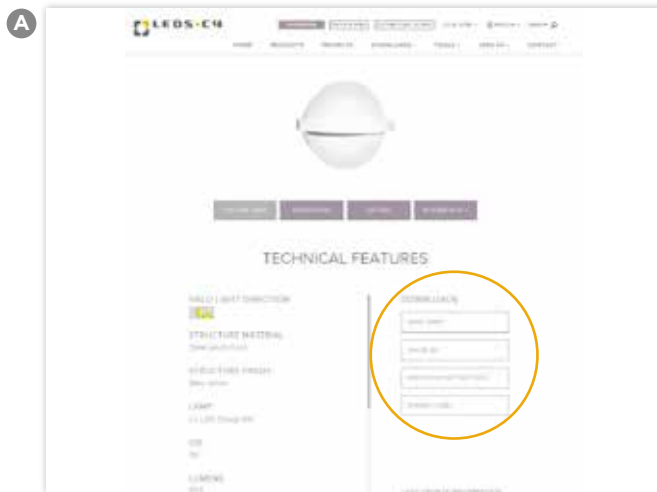

WEBSERVICE

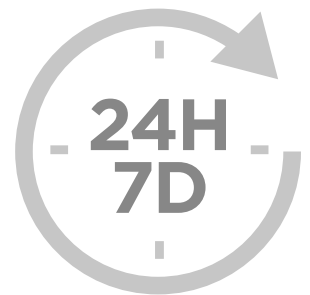

COLOUR CONTROL

- Unificación de las temperaturas de color por cada tonalidad.
- Segmentación estricta de los bins y steps MacAdam.
- Selección de fabricantes de led con garantías de producto e innovación.

- Vereinheitlichung der Farbtemperaturen der verschiedenen Farbtöne.
- Akkurate Segmentierung von Bins und Steps MacAdam.
- Auswahl von LED-Herstellern, die Qualität und Innovation garantieren.

- Унификация цветových температур для каждого оттенка.
- Лаборатория точной сегментации типов и шагов МакАдама.
- Выбор производителей светодиодов, дающих гарантии надежности и современности продукта.

- Unification of colour temperatures for each tone.
- Accurate segmentation of MacAdam bins and steps.
- Selection of LED manufacturers providing product guarantee and innovation.

- Unificazione delle temperature di colore per ciascuna tonalità.
- Segmentazione accurata dei bin e degli step MacAdam.
- Selezione dei produttori di led con garanzie di prodotto e innovazione.

- Ujednolicenie temperatur koloru dla każdej tonacji.
- Staranny podział binów i stopni MacAdam.
- Dobór producentów diod gwarantujących produkt i jego innowacyjność.

- Unification des températures de couleur pour chaque tonalité.
- Segmentation précise des bins et des steps MacAdam.
- Sélection de fabricants de LED qui offrent des garanties en termes de produit et d'innovation.

- Unificação das temperaturas de cor por cada tonalidade.
- Segmentação cuidada dos bins e steps MacAdam.
- Seleção de fabricantes de LED com garantias de produto e inovação.

CERTIFICACIONES | CERTIFICATIONS | CERTIFICAZIONI | ZERTIFIZIERUNGEN | CERTIFICAZIONI | CERTIFICAÇÕES | СЕРТИФИКАЦИИ | CERTYFIKATY



Laboratorio de ensayos en proceso de implantación ISO17025.

Testing Laboratory undergoing validation of iso ISO17025.

Laboratoire d'essais en cours d'implantation ISO17025.

Akkreditierungsverfahren nach ISO17025 für Prüflabor läuft.

Laboratorio di prove in processo di implementazione ISO17025.

Laboratório de ensaios em processo de implementação ISO17025.

В настоящее время испытательная лаборатория приводится в соответствие со стандартом ISO17025.

Laboratorium badawcze w trakcie procesu wdrażania ISO17025.

**HIGH
PERFORMANCE
SMART
TECHNOLOGY
EXCELLENT
DESIGN**



INTEGRAL LIGHTING EXPERIENCE

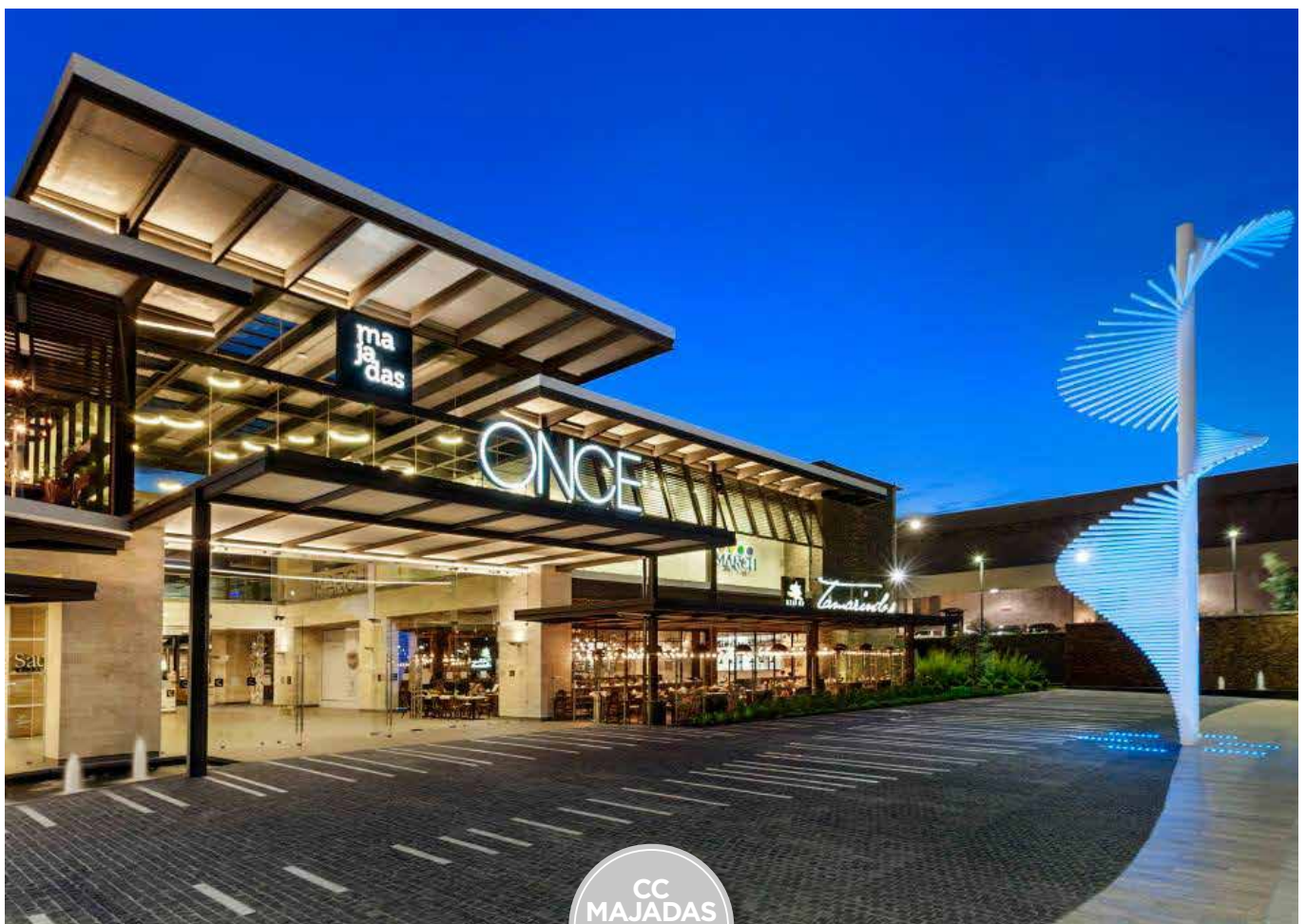

CC
MAJADAS
ONCE
GUATEMALA

DIALux

CONSULTORÍA DE ILUMINACIÓN
LIGHTING CONSULTANCY
CONSEIL EN ÉCLAIRAGE
CONSULENZA DI ILLUMINAZIONE
LICHTPLANUNG UND BELEUCHTUNGSBERATUNG
CONSULTADORIA EM ILUMINAÇÃO
КОНСУЛЬТАЦІЯ ПО ОСВЕЩЕНІЮ
DORADZTWO OŚWIETLENIOWE



BESPOKE SOLUTIONS CUSTOM MADE

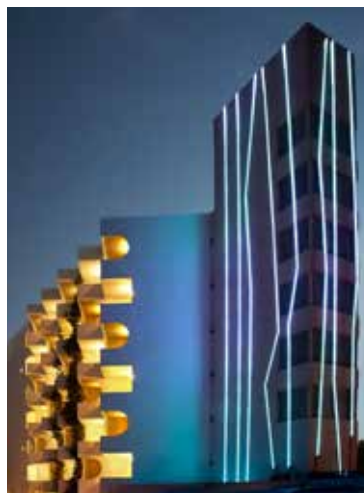

HOTEL PAMPLONA

■ Capacidad para desarrollar a medida cualquier solución requerida.

■ Kapazität zur Entwicklung aller benötigten technischen Lösungen.

■ Возможность разработки абсолютно индивидуального решения для любых потребностей.

■ Ability to develop any bespoke solution required.

■ Capacità di sviluppare su misura qualsiasi soluzione richiesta.

■ Zdolność opracowania rozwiązania na miarę każdej potrzeby.

■ Capacité à développer n'importe quelle solution requise sur mesure.

■ Capacidade para desenvolver qualquer solução necessária à medida.

HOSPITALITY
OUTDOOR
RETAIL
RESIDENTIAL
REST & BARS
ARCHITECTURAL
COMMERCIAL
ART & CULTURE



OUR PRODUCTS

TECHNICAL
DECORATIVE
OUTDOOR

TECHNICAL

PROYECTORES Y CARRILES | SPOTLIGHTS AND TRACKS | PROJECTEURS ET RAILS | STRAHLER UND SCHIENEN | PROIETTORI E BINARI | PROJETORES E CALHAS | ПРОЖЕКТОРЫ И ШИНОПРОВОДЫ | ПРОЈЕКТОРЫ I SZYNY



ROUND DOWNLIGHTS | DOWNLIGHTS REDONDOS | DOWNLIGHTS ROUNDS | RUNDE DOWNLIGHTS | DOWNLIGHTS ROTONDI | DOWNLIGHTS REDONDOS | КРУГЛЫЕ ВСТРАИВАЕМЫЕ СВЕТИЛЬНИКИ | OKRĘGŁE OPRAWY TYPU DOWNLIGHT





SQUARE DOWNLIGHTS | DOWNLIGHTS CUADRADOS | DOWNLIGHTS CARRÉS | ECKIGE DOWNLIGHTS | DOWNLIGHTS QUADRATI
 | DOWNLIGHTS QUADRADOS | КВАДРАТНЫЕ ВСТРАИВАЕМЫЕ СВЕТИЛЬНИКИ | KWADRATOWE OPRAWY TYPU DOWNLIGHT



BACKLIGHT 124



BACO 152



DELTA COB 126



EIS 88



EQUAL S 120



ECOFIT 122



FÓRMULA 89



GES 94



MINI 90



MINI EVOLUTION 89



MINI PLAY 114



MULTIDIR 144



MULTIDIR EVO S 136



MULTIDIR EVO L 136



OUT SQUARE 132



PAT 84



PLAY 108



PLAY DECO SQUARE 102



ZOE 89

TECHNICAL



LINEAL LIGHTING SYSTEMS | SISTEMAS LINEALES DE ILUMINACIÓN | SYSTÈMES D'ÉCLAIRAGE LINÉAIRES | LINEARE BELEUCHTUNGSSYSTEME | SISTEMI LINEARI D'ILLUMINAZIONE | SISTEMAS LINEARES DE ILUMINAÇÃO | ЛИНЕЙНЫЕ СИСТЕМЫ ОСВЕЩЕНИЯ | LINIOWE SYSTEMY OŚWIETLENIOWE

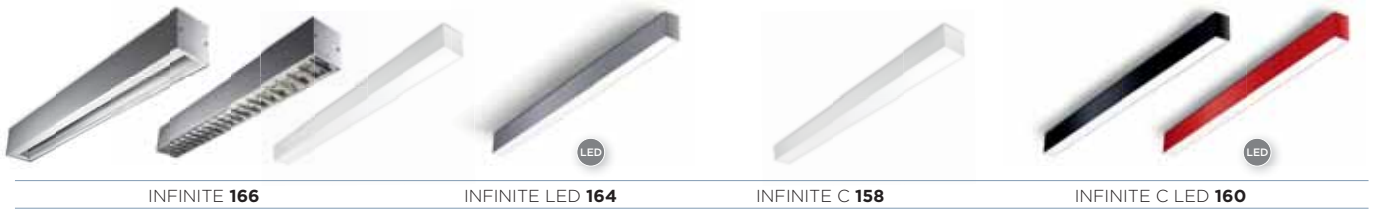

INFINITE 166

INFINITE LED 164

INFINITE C 158

INFINITE C LED 160



SUSPENDIDOS | SUSPENDED | SUSPENSIONS | HÄNGELEUCHTEN | SOSPENSIONI | SUSPENSÕES | ПОДВЕСНЫЕ | ZWIESZANE

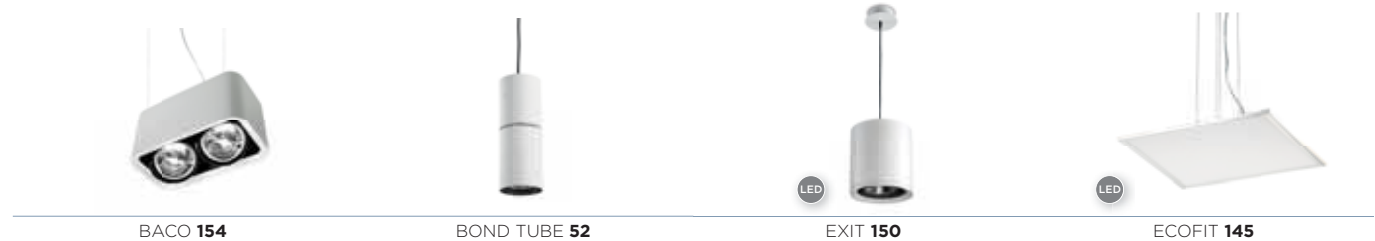

BACO 154

BOND TUBE 52

EXIT 150

ECOFIT 145



INFINITE 164

INFINITE LED 162



PEK 174

PLAY DECO SURFACE 106



SEÑALIZACIÓN | SIGNAL | SIGNALISATION | SIGNALISIERUNG | SEGNALETICA | SINALIZAÇÃO |
 МАРКЕРНАЯ ПОДСВЕТКА | SYGNALIZACJA



LED

BIT 186



LED

DOT 187



LED

LEO 184



LED

OXY 185



SECRET 190



LED

SIGN 192



LED

STEP 188



TIRAS LED | LED STRIPS | BANDEAUX À LED | LED-BÄNDER | STRISCHE LED | FITAS LED |
 СВЕТОДИОДНЫЕ ЛЕНТЫ | PASKI LED



NEW

LED

DEEP 204



LED

ION 196



LED

ON 196



LED

ON ECO 199



LED

ON IP ECO 198



LED

ON HP 200



LED

ON HP IP 201



LED

ON SP 202



LED

ON SP IP 203



LED

ZENIT 203



NEW

LINEAL 206

DECORATIVE

COLGANTES | PENDANTS | SUSPENSIONS | PENDELLEUCHTEN | PENDENTI | PENDENTS | ПОДВЕСНЫЕ СВЕТИЛЬНИКИ | LAMPY WISZĄCE

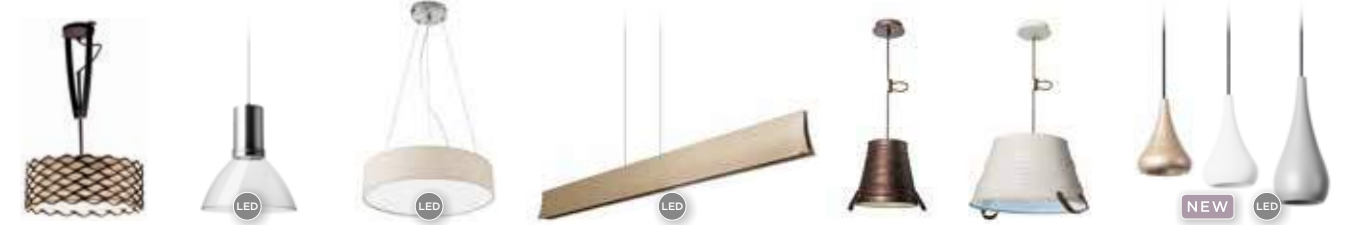

ALSACIA 258 BELL 374 - 375 BOL 354 - 355 BRAVO 214 - 215 BUCKET 390 - 391 CHERRY 366 - 367



COLOR 368 - 371 CUP 242 - 243 CURL 218 - 219 CURL 220 - 221 CUMBIA 397

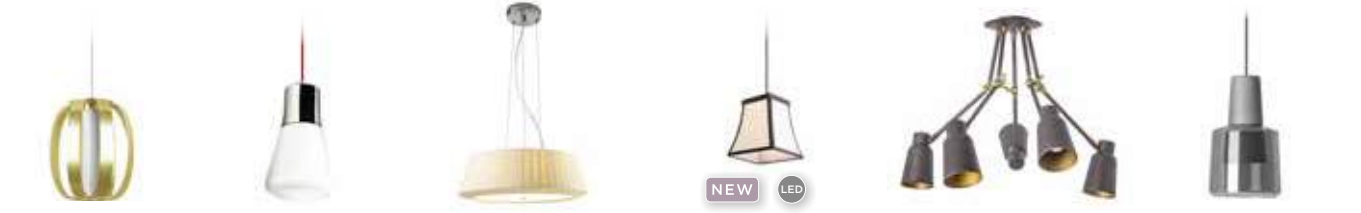

DREAM 382 - 383 DROP 380 FLORENCIA 356 - 357 FANCY 254 - 255 FUNK 230 - 231 KHOI 372 - 373



MAGMA 246 - 247 MECANO 394 - 395 NEO 392 - 393 NIMES 381 PIPE 238 - 240



RAW 224 ROAD 222 - 223 ROCKET 377 - 379 SEK 212 - 213 SPICA 266 - 267



STYLUS 234 - 237 SUGAR 384 - 385 SVEN 376 TRAMA 244 - 245 UP & DOWN 396



VINTAGE 386 - 389 VINTAGE 226 - 227 VIRGINIA 250



PLAFONES | CEILING FIXTURES | PLAFONIERS | DECKENLEUCHTEN | PLAFONIERE | PLAFONES |
ПОТОЛОЧНЫЕ СВЕТИЛЬНИКИ | PLAFONIERY



ALPEN 362 - 363



ALSACIA 258



AUDREY 365



LED

BOL 354 - 355



BOB 436 - 437



NEW LED

BUBBLE 430 - 431



LED

CLIP 364



DEC 434



NEW LED

DRONE 342 - 345



FLORENCIA 356 - 357



FLOW 432 - 433



PARMA 435



PIPE 240 - 241



RAS 360 - 361



ROUND 365



LED

SATURN 348



LED

STRATA 350 - 351



NEW LED

STYLUS 236



SUNNY 332



LED

TOLEDO 358 - 359



TRAMA 244 - 245



WOOD 346 - 347



LED

WOW 352 - 353

DECORATIVE

APLIQUES | WALL FIXTURES | APPLIQUES | WANDLEUCHTEN | LAMPADE DA PARETE | APLIQUES
 | НАСТЕННЫЕ СВЕТИЛЬНИКИ | LAMPY ŚCIENNE

		 NEW LED	 LED	 LED	 LED	 LED
ALSACIA 258 - 259	ALU 333	APPLY 298 - 299	BALMORAL 294 - 295	BRAVO 214 - 215	BED 305	BOOK 304
	 LED	 NEW	 NEW LED	 LED	 LED	
BREMEN 330	BUC 292 - 293	COLOR 368 - 369	CUP 242 - 243	CURL 218	DIDO 296	
 NEW LED						
DRONE 342 - 345	ESTAK 297	FLEX 400 - 401	FUNK 232			
 NEW LED	 LED					
FANCY 254 - 255	GES 322 - 323	GLASS 337	HALF 331			
 LED	 LED	 LED	 LED	 LED	 LED	 LED
IVY 301	JET 315	JET 316 - 317	KUB 314	LIA 328	LIA LED 326 - 327	LLIT 306
			 NEW LED			
LUGO 336	MAKE UP 418	NEMESIS 329	NEU 318 - 319	NIZA 335	NOK 339	
 LED	 LED			 LED	 NEW LED	
ON-OFF 300	OVAL 324 - 325	PIPE 240	PRACTIC 334	QUEEN 308 - 309	RACK 290 - 291	



PANTALLAS | SHADES | ABAT-JOUR | STOFFSCHIRME | PARALUME | АБАЖУР | АБАЖУРА | АБАЖУРЫ



DECORATIVE

 SOBREMESAS | TABLE LAMPS | LAMPES DE TABLE | TISCHLEUCHTEN | DA TAVOLO | CANDEEIROS DE MESA |
 НАСТОЛЬНЫЕ СВЕТИЛЬНИКИ | LAMPY STOŁOWE



ALSACIA 258 BRAVO 214 - 215 BRISTOL 269 DELUXE 279 DEVON 280 DOVER 277 ELVA 399



FANCY 256 FLEX 400 - 401 FUNK 233 LYON 284 MICHIGAN 282 MILAN 286



NEXT 398 QUEEN 402 - 403 RAW 225 SPICA 266 TORINO 274 TWIST 252



VIRGINIA 250



PIES DE SALÓN | FLOOR LAMPS | LAMPADAIRES | STEHLEUCHTEN | PIEDISTALLO DA SALONE |
CANDEEIROS DE SALA | ТОРШЕРЫ | LAMPY PODŁOGOWE



ABERDEEN 410



ALSACIA 258 - 259



LED

BRAVO 214 - 215



BRISTOL 269



DELUXE 279



DEVON 280 - 281



CRETA 406



DOVER 277



LED

ELVA 399



EXTEND 411



NEW LED

FANCY 257



FUNK 233



LED

JAZZ 408 - 409



LYON 285



MAGMA 248 - 249



MEMPHIS 405



MICHIGAN 283



MILAN 286 - 287



LED

PING 407



LED

LED

QUEEN 402 - 405



SPICA 267



TORINO 275



TWIST 252



VINTAGE 228 - 229



VIRGINIA 250

DECORATIVE



BAÑO | BATH | SALLE DE BAINS | BAD | BAGNO | CASA DE BANHO |
 ДЛЯ ВАННЫХ КОМНАТ | ŁAZIENKOWE

IP



BATH 426



BELYSA 417



BOB 436 - 437



NEW LED

BUBBLE 430 - 431



CONCEPT 416



DEC 434



DRESDE 424



DRESDE EVO 425



DRESDE ON 426



FLOW 432 - 433



GLANZ 443



LORIENT 429



ONDA 428



ORION 427



PARMA 435



REFLEX 444 - 446



LED



SPLASH 414 - 415

NEW LED



SKARA 419



TOILET 420 - 421

LED



TOILET Q 422 - 423

LED



VANITY 447



EMPOTRABLES | DOWNLIGHTS | ENCASTRÉS | EINBAULEUCHTEN | ILLUMINAZIONE DA INCASSO |
 ENCASTRÁVEIS | ВСТРОЕННЫЕ ПОТОЛОЧНЫЕ | DOWNLIGHTY



EIS 438 - 439



FÓRMULA 442



SPLIT 440 - 441



VENTILADORES | VENTILATEURS | DE PLAFOND | DECKENVENTILATOREN |
VENTILATORI DA SOFFITTO | VENTILADORES DE TECTO | ВЕНТИЛЯТОРЫ | WENTYLATORY SUFITOWE



AUKENA 472 - 473



BAHIA 466 - 467



BELMONT 478 - 479



BORNEO 470 - 471



BOUVET 484



CEOS 458 - 459



DOMINICA 485



FORMENTERA 468 - 469



FUS 464 - 465



GARBÍ 452 - 453



HAWAI 474 - 475



KLAR 460 - 461



MOGAN 490 - 491



PHUKET 482 - 483



RODAS 492 - 493



SAMAL 476 - 477



STEM 486 - 487



TIGA 454 - 457



TORONTO 480 - 481



TUPAI DC 488 - 489



VINTAGE 462 - 463

OUTDOOR

PROYECTORES | SPOTLIGHTS | PROJECTEURS ET SPOTS | STRAHLER | RIFLETTORI | PROJECTORES | ПРОЖЕКТОРЫ | SPOTLIGHTY

				
ALIEN 508	NEW LED APRIL 507	NEW LED SEASIDE SUITABLE AQUA 502	LED CUBE 496	EOLO 510
				
NEW SEASIDE SUITABLE ESPARTA 508	SEASIDE SUITABLE HELIO 510-511	LED SEASIDE SUITABLE HUBBLE 498-500	ICARO 510	
				
NEW LED SEASIDE SUITABLE MICRO 501	LED SEASIDE SUITABLE MIDI 502	LED POWELL 496-497	LED PREMIER 504	LED SEASIDE SUITABLE PROY 506
				
LED RAY 505	LED SHULL 506	NEW LED SKADE 506, 510		

BAÑADORES DE PARED | WALL WASHERS | LÈCHE-MURS | WANDBELEUCHTUNG | WALL WASHERS | ПРОЈЕКТОРЕS WALL WASHER | НАСТЕННЫЕ КОСТЮМЫ | ОПРАВЫ ТИПУ WALL WASHERS

			
NEW LED CONVERT 513	HECATE 514	LED LT-20 518	NEW LED POMPEYA 516
			
LED SANAT 512	LED TRON 515		



EMPOTRADOS | RECESSED | ENCASTRÉS | EINBAULEUCHTEN | INCASSI | ENCASTRÁVEIS | ВСТРАИВАЕМЫЕ | WPUSZCZANE



LED SEASIDE SUITABLE

GEA 574-577



LED SEASIDE SUITABLE

BASIC 584



LED SEASIDE SUITABLE

GEA 584



LED SEASIDE SUITABLE

HERCULES 582



NEW LED SEASIDE SUITABLE

MICENAS 578-581, 584-585



NEW LED SEASIDE SUITABLE

GEA 586-603



LED SEASIDE SUITABLE

XENA 600, 604-605



SUMERGIBLES | WATERPROOF | SUBMERSIBLES | VERSENKBARE LEUCHTEN | LUCI SOMMERGIBILI | SUBMERSÍVEIS | ПОГРУЖАЕМЫЕ В ВОДУ | ZANURZALNE



NEW LED SEASIDE SUITABLE

AQUA 644-649

OUTDOOR

APLIQUES | WALL FIXTURES | APPLIQUES | WANDLEUCHTEN | APPLIQUE | APLIQUES | НАСТЕННЫЕ | KINKIETY

 NEW SEASIDE OUTDOOR ACCESS 542	 NEW LED AFRODITA 520-526, 536	 AJAX 560	 ALFA 548	 NEW ALVIN 524	
 NEW LED ANGLE 544	 ATENEA 538	 SEASIDE OUTDOOR BASIC 557	 NEW LED BASIC ALUMINIUM 556, 557	 LED CLOUS 532	
 LED CORNER 548	 LED COSMOS 536	 LED CUBUS 546	 NEW LED CURIE 540, 542	 SEASIDE OUTDOOR DARWIN 554	
 DELPHOS 539	 LED SEASIDE OUTDOOR DIAGO 530	 ELECTRA 560	 NEW LED FINESTRA 527	 HAMMER 546	 HEBE 558
 ICARO 546	 LED JEP 554	 NEW LED SEASIDE OUTDOOR KÖSSEL 550, 552	 LED LOTTERY 552	 MANDELA 558	
 LED MONACO 559	 SEASIDE OUTDOOR NAPOLI 538	 NEW LED NEMESIS 534-535, 538	 NEREO 560	 SEASIDE OUTDOOR OPAL 555	
 SEASIDE OUTDOOR PIRAMID 542	 LED POKER 528	 SEASIDE OUTDOOR PRIAP 561	 SELENE 538	 LED SPACE 558	 LED SURF 548



NEW LED

TAYLOR **531-532**



NEW LED

TERRY **536**



THOMAS **554**



NEW LED SEASIDE SUSTAINABLE

TURTLED **552**



NEW LED

VENUS **530**



LED

WILSON **528**



ZEUS **556**

PLAFONES | CEILING FIXTURES | PLAFONNIERS | DECKENLEUCHTEN | PLAFONIERE | TECTOS |
ПОТОЛОЧНЫЕ СВЕТИЛЬНИКИ | OPRAWY SUFITOWE



LED

AFRODITA **562, 564**



LED SEASIDE SUSTAINABLE

BASIC **570**



LED

BASIC ALUMINIUM **571**



LED

COSMOS **568**



LED

JEP **554**



LED SEASIDE SUSTAINABLE

KÖSSEL **566**



LED SEASIDE SUSTAINABLE

LOFT **572**



LED SEASIDE SUSTAINABLE

OPAL **572**

SENSOR



LED SEASIDE SUSTAINABLE

PREMIUM **563**



SELENE **568**



NEW LED

SOLID **564**

OUTDOOR

BALIZAS | BOLLARDS | BALISES | POLLER | FARI | PIMENTEIROS | НАЗЕМНЫЕ СТОЛБЫ | SŁUPKI



BALIZAS 614-616

CILIN 610

COMPACT 607

COSMOS 622

CUBASE 629

CUBIK 628



DIAGO 624

ELECTRA 626

HAUTE 610

HEBE 624

HELION 620

ICARO 622



MANDELA 624

MÜLLER 620

NEWTON 608-609

NOTT 617-618



ODIN 606

PILE 625

PRIAP 626-627

REXEL 606

SMILE 618



LED

SPACE **620**



TEMIS **612**



SEASIDE
SUITABLE

TORCH **612**



SENSOR

LED

TWO-LIGHT **621**



WAY **622**

FAROLAS | STREET LIGHTS | RÉVERBÈRES | MASTLEUCHTEN | LAMPIONI | POSTES DE ILUMINAÇÃO | ΦΟΗΑΡΙ | LAMPY ULICZNE



NEW

LED

BOHEMIA **640**



LED

CITIZEN **630**



NEW

LED

ELIPSE **636**



SEASIDE
SUITABLE

NEW

LED

LYON **630**



LED

GLAVA **636**



HEADS **642**



NEW

LED

MERIDIAN **638**



POMPEYA **642**



NEW

LED

PROUD **643**



LED

SCAN-RAY **634**



TEMIS **632**



OUTDOOR



CLASSIC | CLÁSICO | CLASSIQUE | KLASSISCH | CLASSICO | CLÁSSICO | КЛАССИЧЕСКИЙ | KLASYCZNY



ALBA **666-667**

GALATEA **670-671**

MARK **662-665**

RUSTICA **668-669**

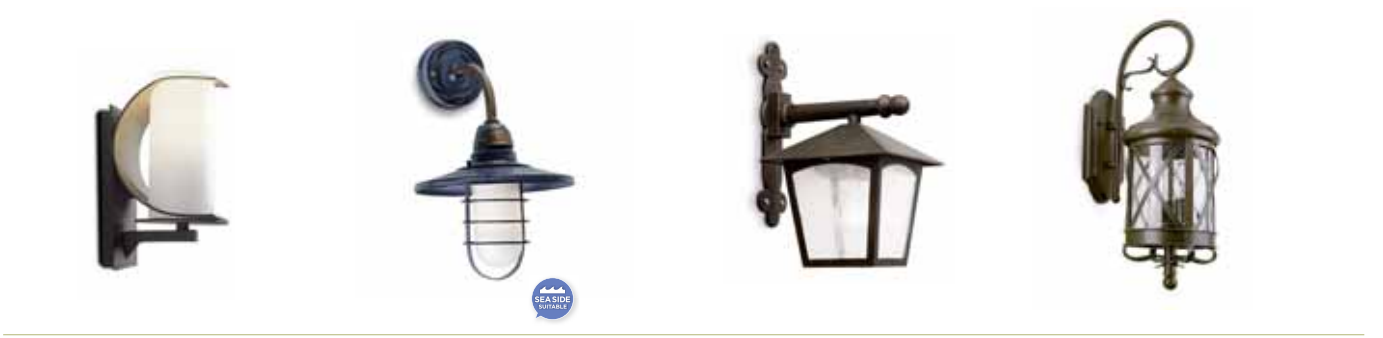

CIRI **672**

COTTAGE **673**

EDIPO **674**

MORFEO **674**



PERSEFONE **675**

PERSEO **674**

SIRENA **672**

TRITON **672**

VINTAGE **661**





CHILLOUT | CHILL-OUT | CHILLOUT | CHILLOUT-BELEUCHTUNG | CHILLOUT | CHILLOUT | ДЛЯ ЗОНЫ ОТДЫХА | CHILLOUT



NEW



BARCINO 657



LED



CISNE 658-659



LED



INVISIBLE 650



JEMBE 660



KAP 656



LED



MOONLIGHT 654



LED



SMOOTH 652

P 676-680

LAMPS



LÁMPARAS | LAMPES | LEUCHTMITTEL | LAMPADINE | LÂMPADAS | ЛАМПЫ | ŻARÓWKI

P 681-703

ELECTRICAL UNITS, ACCESSORIES & TECHNICAL INFORMATION



UNIDADES ELÉCTRICAS / ACCESORIOS / INFORMACIÓN TÉCNICA | PLATINES ÉLECTRIQUES / ACCESSOIRES / INFORMATIONS TECHNIQUES | NETZTEILE / ZUBEHÖRE / TECHNISCHE ANGABEN | UNITÀ ELETTRICHE / ACCESSORI / INFORMAZIONI TECNICHE | UNIDADES ELÉTRICAS / ACESSÓRIOS / INFORMAÇÃO TÉCNICA | ЭЛЕКТРООБОРУДОВАНИЕ / АКССУАРЫ / ТЕХНИЧЕСКАЯ ИНФОРМАЦИЯ | CZĘŚCI ELEKTRYCZNE / AKCESORIA / INFORMACJA TECHNICZNA



TECHNICAL

38-209

DECORATIVE

210-493

448-493

CEILING FANS

OUTDOOR

494-675

LAMPS, ELECTRICAL UNITS, & ACCESSORIES

676-703



TECHNICAL



42-77 SPOTLIGHTS AND TRACKS

PROYECTORES Y CARRILES
PROJECTEURS ET RAILS
STRAHLER UND SCHIENEN
PROIETTORI E BINARI
PROJETORES E CALHAS
ПРОЖЕКТОРЫ И ШИНОПРОВОДЫ
PROJEKTORY I SZYNY



156-171 LINEAL LIGHT SYSTEMS

SISTEMAS LINEALES DE ILUMINACIÓN
SYSTÈMES D'ÉCLAIRAGE LINÉAIRES
LINEARE BELEUCHTUNGSSYSTEME
SISTEMI LINEARI D'ILLUMINAZIONE
SISTEMAS LINEARES DE ILUMINAÇÃO
ЛИНЕЙНЫЕ СИСТЕМЫ ОСВЕЩЕНИЯ
LINIOWE SYSTEMY OŚWIETLENIOWE



182-193 SIGNAL

SEÑALIZACIÓN
SIGNALISATION
SIGNALISIERUNG
SEGNALETICA
SINALIZAÇÃO
МАРКЕРНАЯ ПОДСВЕТКА
SYGNALIZACJA



78-155 DOWNLIGHTS

DOWNLIGHTS
DOWNLIGHTS
DOWNLIGHTS
DOWNLIGHTS
DOWNLIGHTS
DOWNLIGHTS
ПОТОЛОЧНЫЕ
OPRAWY TYPU DOWNLIGHT



172-181 SUSPENDED

SUSPENDIDOS
SUSPENSIONS
HÄNGELEUCHTEN
SOSPENSIONI
SUSPENSÕES
ПОДВЕШНЫЕ
ZWIESZANE



194-209 LED STRIPS

TIRAS LED
BANDEAUX À LED
LED-BÄNDER
STRISCE LED
FITAS LED
СВЕТОДИОДНЫЕ ЛЕНТЫ
PASKI LED

CRI

COLOUR RENDERING INDEX



CRI - Es la medida que se utiliza para determinar la capacidad que tiene una fuente luminosa para reproducir fielmente los colores de varios objetos en comparación a la fuente de luz natural e ideal, el sol. Las luminarias con un IRC elevado son necesarias en aplicaciones donde la reproducción del color es importante, por ejemplo, en la iluminación de textiles y alimentación.

CRI- It is the measure used to determine the ability of a light source to reveal the colours of various objects faithfully in comparison with the ideal or natural light source, the sun. High CRI lights are needed in those applications where colour reproduction is important, such as textile and food sector light.

IRC Indice de rendu des couleurs : permet de mesurer la capacité d'une source lumineuse à reproduire fidèlement les couleurs d'objets divers par rapport à la source de lumière naturelle idéale que constitue le soleil. Les luminaires à IRC élevé sont nécessaires dans les applications où la reproduction de couleur est importante, notamment pour l'éclairage textile et alimentaire.

CRI - Der Farbwiedergabeindex ist eine Kennzahl, mit der die Qualität der Farbwiedergabe von Lichtquellen beschrieben wird. Sie gibt für jede Lichtquelle an, wie sehr die Farbwiedergabe vom Ideal des Tageslichts abweicht. Leuchten mit hohem CRI sind notwendig, wenn die Farbwiedergabe wichtig ist, zum Beispiel bei der Beleuchtung von Textilien und Lebensmitteln.



LOW CRI

HIGH CRI

El catálogo técnico de LEDS-C4 presenta diferentes soluciones con alto CRI, superior a 90, para conseguir reproducir los colores fielmente de los productos iluminados y mejorar su presentación.

LEDS-C4 technical catalogue presents different solutions with a high CRI (over 90) able to reveal the colours from lit products faithfully and thus, to improve their presentation.

Le catalogue technique de LEDS-C4 propose différentes solutions à IRC élevé (supérieur à 90) qui permettent de reproduire fidèlement les couleurs des produits éclairés et d'en améliorer ainsi la présentation.

Der Katalog von LEDS-C4 enthält verschiedene Lösungen mit hohem CRI (höher als 90), die für eine genaue Farbwiedergabe der beleuchteten Produkte und eine optimale Präsentation sorgen.

Il catalogo tecnico di LEDS-C4 presenta diverse soluzioni con un IRC elevato (superiore a 90) che riescono a riprodurre fedelmente i colori dei prodotti illuminati e ne migliorano la presentazione.

O catálogo técnico da LEDS-C4 apresenta diferentes soluções com elevado CRI (superior a 90) que conseguem reproduzir fielmente as cores dos produtos iluminados e melhoram a sua apresentação.

Технический каталог фирмы LEDS-C4 представляет различные решения с использованием ламп с высоким показателем CRI (выше 90), которые достоверно передают цвета освещаемых предметов и улучшают их внешний вид.

Katalog techniczny LEDS-C4 przedstawia różne rozwiązania o wysokim CRI (wyższym niż 90), które są w stanie wiernie oddać kolory oświetlonych produktów i poprawiają sposób ich prezentacji.

CRI - È la misura che si utilizza per determinare la capacità di una fonte luminosa di riprodurre fedelmente i colori di vari oggetti in confronto alla luce naturale e ideale, il sole. Le lampade con un IRC elevato sono necessarie in applicazioni in cui la riproduzione del colore è importante, per esempio nell'illuminazione di tessuti e nell'alimentazione.

CRI - É a unidade que mede a capacidade de uma fonte luminosa para reproduzir fielmente as cores de vários objetos comparativamente à fonte de luz natural e ideal, o sol. As luminárias com um CRI elevado são necessárias em aplicações onde a reprodução da cor é importante, por exemplo, na iluminação de têxteis e alimentação.

Индекс цветопередачи (**CRI**) - это мера, которой определяется способность источника света передавать цвета различных предметов по сравнению с источником натурального и идеального освещения, то есть солнца. Светильники с высоким показателем CRI необходимы там, где цветопередача особенно важна, например, при освещении текстильной продукции или продуктов питания.

CRI - to wielkość, która jest używana w celu określenia zdolności źródła światła do wiernego oddawania kolorów różnych przedmiotów w porównaniu z naturalnym lub idealnym źródłem światła, słońcem. Oprawy oświetleniowe o wysokim CRI są konieczne do zastosowania tam, gdzie ważne jest odtwarzanie kolorów, na przykład przy oświetleniu wyrobów włókienniczych i produktów spożywczych.

TECHNICAL

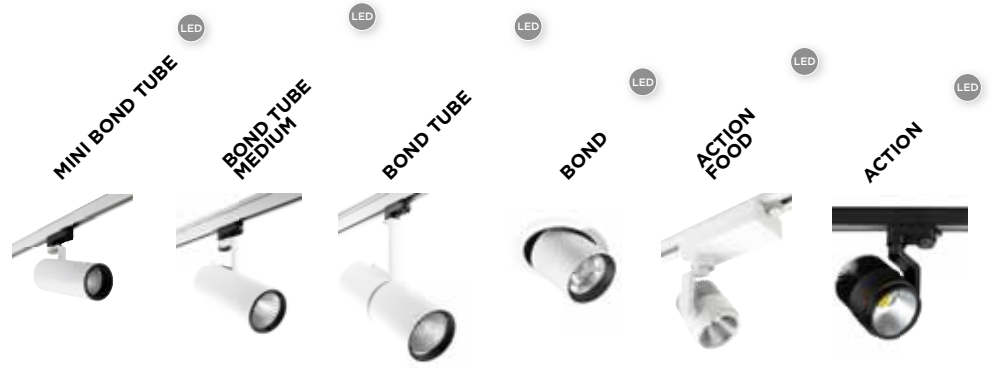

P. 44

P. 46

P. 48

P. 54

P. 60

P. 58



■

■

■

■

■



■

■

■

■



■

■

■

■

■



14

■

■

■

■

■

■



60

■

■

■

■

■

QR-111/G53

■

■

■

CDM-R111/GX8.5 35W

■

CDM-R111/GX8.5 70W

■

HIT-T/G12 35W

■

■

■

HIT-T/G12 70W

■

■

■

HIT-T/G12 100W

AR-111/GU10 -

■

■

QPAR-16/GU10 -

LED TRIDONIC -

■

LED Zhaga -

■

■

■

■

■

LED Zhaga CRI90 -

■

■

■

■

LED PHILIPS CRI92 -

LED CRI93 -



10°

■

■

■

11°

12°

■

15°

■

■

■

19°

20°

■

24°

■

■

■

■

28°

30°

■

■

35°

36°

■

■

38°

■

■

40°

45°

■

■

50°

■

55°

■

90X60°



■

■

■

■

■

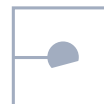

SPOTLIGHTS AND TRACKS

PROYECTORES Y CARRILES
 PROJECTEURS ET RAILS
 STRAHLER UND SCHIENEN
 PROIETTORI E BINARI
 PROJETORES E CALHAS
 ПРОЖЕКТОРЫ И ШИНОПРОВОДЫ
 PROJEKTORY I SZYNY

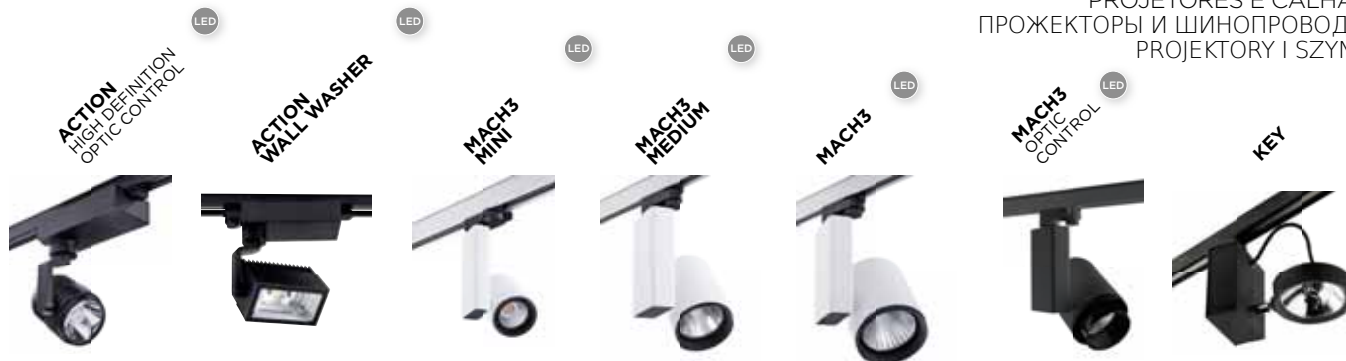

P. 62

P. 66

P. 70

P. 71

P. 72

P. 73

P. 74

■	■	■	■	■	■	■	■
		■	■	■	■	■	■
		■	■	■	■	■	■
■	■	■	■	■	■	■	■
■	■	■	■	■	■	■	■
							■
							■
							■
							■
							■
	■	■	■	■	■		
	■	■	■	■	■		
						■	
■							
■							
		■		■		■	
			■				■
		■			■		
			■				■
				■			
					■		
						■	
							■
■	■	■	■	■	■	■	■





MINI BOND TUBE

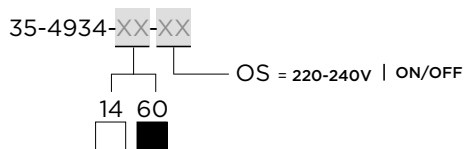
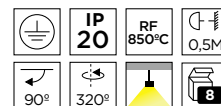
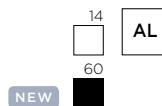
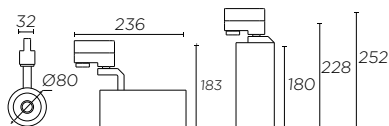

LED OSRAM
Zhaga Standard

CRI 80

XX XX

A**... A	35-4934	14 60	- OS	20°	3000K	25,7W	2000 lm	
	35-4935			30°				
	35-4936			50°				
	35-4937			20°				
	35-4938			30°				
	35-4939			50°				

Accesorios / Accessories / Accessoires / Zubehöre / Accessori / Acessórios / Аксессуары / Akcesoria



ACT-9105-14-00



ACT-9105-60-00



ACT-9106-14-00



ACT-9106-60-00



+

ACT-9105-14-00



ACT-9105-60-00







BOND TUBE MEDIUM NEW

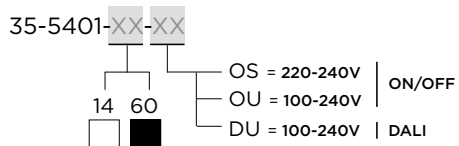
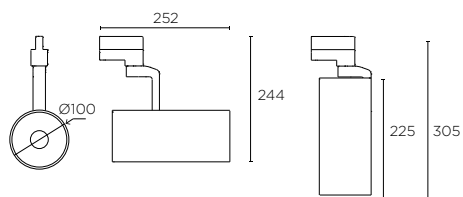

LED CREE Zhaga Standard

A**... A

	CRI80	XX	XX					
35-5380				15°	3000K	2040 lm	17,4W	
35-5381	14	OS	30°					
35-5382	-	-	55°					
35-5394				15°	4000K			
35-5396	60	OU	30°					
35-5397			55°					
35-5401				15°	3000K	2670 lm	25,9W	
35-5411	14	OS	30°					
35-5412	-	-	55°					
35-5413				15°	4000K			
35-5414	60	DU	30°					
35-5415			55°					
<b style="background-color: #4a7c9c; color: white; padding: 2px;">CRI90								
35-5398				15°	3000K	1540 lm	17,4W	
35-5399	14	OS	30°					
35-5400		OU	55°					
35-5416				15°	4000K	2020 lm	25,9W	
35-5417	60	OS	30°					
35-5418		OU	55°					

Accesorios / Accessories / Accessoires / Zubehöre / Accessori / Acessórios / Аксессуары / Akcesoria



ACT-9105-14-00



ACT-9105-60-00



ACT-9106-14-00



ACT-9106-60-00



+

ACT-9105-14-00



ACT-9105-60-00







BOND TUBE

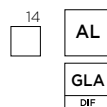
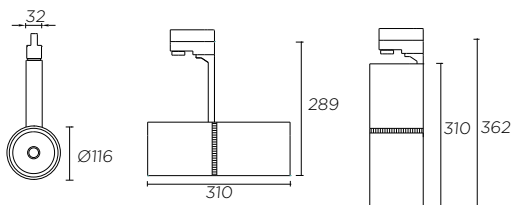

LED CREE Zhaga Standard A**... A

CRI 80

XX XX

35-3561			15°	3000K	2670 lm	25,9W	
35-3562		OS	24°				
35-3563	- 14 -	OU	36°				
35-3564			15°	4000K			
35-3565		DU	24°				
35-3566			36°				

35-3570			15°	3000K	3380 lm	33,7W	
35-3571			24°				
35-3572			36°				
35-3573			15°	4000K			
35-3574			24°				
35-3575			36°				
35-3952	- 14 -	OU	15°	3000K	4600 lm	44,8W	
35-3953			24°				
35-3954			36°				
35-3955			15°	4000K			
35-3956			24°				
35-3957			36°				

CRI 90

35-3567		OS	15°	3000K	2020 lm	25,9W	
35-3568		OU	24°				
35-3569	- 14 -	DU	36°				
35-3958			15°	4000K	3490 lm	44,8W	
35-3959		OU	24°				
35-3960			36°				



QR-111

G53
A**... C

35-3554-14-00	<input type="checkbox"/>	max.100W		220-240V 50-60Hz		O9-14
---------------	--------------------------	----------	--	---------------------	--	-------

HIT-T

G12
A*... A

35-3555-14-37	<input type="checkbox"/>	10°	35W		220-240V 50-60Hz
35-3556-14-37	<input type="checkbox"/>	24°			
35-3557-14-37	<input type="checkbox"/>	45°			
35-3558-14-37	<input type="checkbox"/>	10°	70W		
35-3559-14-37	<input type="checkbox"/>	24°			
35-3560-14-37	<input type="checkbox"/>	45°			

AR-111 LED

GU10 (max. H=100 mm)
A*... A

35-3553-14-00	<input type="checkbox"/>	-	max. 15W		22-25
---------------	--------------------------	---	----------	--	-------

Accesorios / Accessories / Accessoires / Zubehöre / Accessori / Acessórios / Аксессуары / Akcesoria



ACT-9135-60-00 HIT-T



ACT-9105-14-00



ACT-9105-60-00



ACT-9106-14-00



ACT-9106-60-00



+

ACT-9105-14-00



ACT-9105-60-00







BOND TUBE

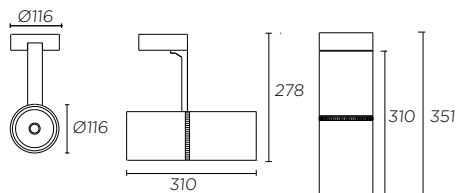

14

AL
GLA
DIF

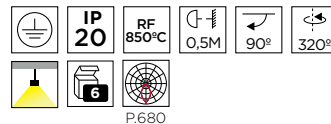

LED CREE
Zhaga Standard
A+... A

CRI 80

XX XX

35-3589			15°	3000K	2670 lm	25,9W	
35-3590		OS	24°				
35-3591	- 14 -		36°				
35-3592			15°	4000K			
35-3593		OU	24°				
35-3594			36°				

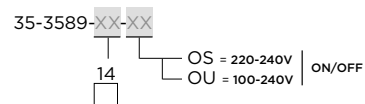

35-3598			15°	3000K	3380 lm	33,7W	
35-3599			24°				
35-3600			36°				
35-3601			15°	4000K			
35-3602			24°				
35-3603	- 14 -	OU	36°				
35-3961			15°	3000K	4600 lm	44,8W	
35-3962			24°				
35-3963			36°				
35-3964			15°	4000K			
35-3965			24°				
35-3966			36°				

CRI 90

35-3595			15°	3000K	2020 lm	25,9W	
35-3596		OS	24°				
35-3597	- 14 -	OU	36°				
35-3967			15°	4000K	3490 lm	44,8W	
35-3968		OU	24°				
35-3969			36°				

LED 3000K 44,8W 15°

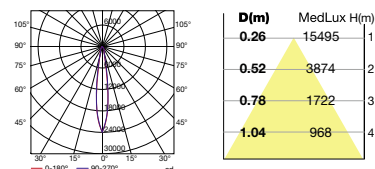

QR-111

G53
A+... C

35-3582-14-00	<input type="checkbox"/>		max.100W		220-240V 50-60Hz		09-14
---------------	--------------------------	--	----------	--	---------------------	--	-------

HIT-T

G12
A+... A

35-3583-14-37	<input type="checkbox"/>		10°	35W		220-240V 50-60Hz
35-3584-14-37	<input type="checkbox"/>		24°			
35-3585-14-37	<input type="checkbox"/>		45°			
35-3586-14-37	<input type="checkbox"/>		10°	70W		
35-3587-14-37	<input type="checkbox"/>		24°			
35-3588-14-37	<input type="checkbox"/>		45°			

AR-111 LED

GU10 (max. H=100 mm)
A+... A

35-3581-14-00	<input type="checkbox"/>		-	max. 15W		22-25
---------------	--------------------------	--	---	----------	--	-------

Accesorios / Accessories / Accessoires / Zubehöre / Accessori / Acessórios / Аксессуары / Akcesoria



ACT-9135-60-00 HIT-T



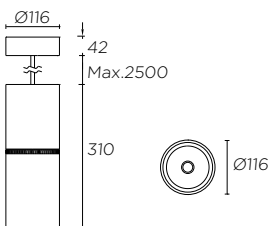

BOND TUBE

**LED CREE**
Zhaga Standard
A+... A**CRI80**

XX XX

35-3621	- 14 -	OS	15°	2670 lm	25,9W		
35-3622			24°				
35-3623			36°				
35-3624		OU	15°				
35-3625			24°				
35-3626			36°				
35-3631	- 14 -	OU	15°	3380 lm	33,7W		
35-3632			24°				
35-3633			36°				
35-3634			15°				
35-3635			24°				
35-3636			36°				
35-3970		OU	OS	15°	4600 lm	44,8W	
35-3971				24°			
35-3972				36°			
35-3973			OU	15°			
35-3974				24°			
35-3975				36°			

CRI90

35-3628	- 14 -	OS OU	15°	2020 lm	25,9W	
35-3629			24°			
35-3630			36°			
35-3976		OU	15°			
35-3977			24°			
35-3978			36°			

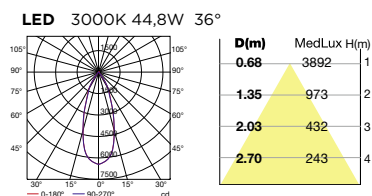
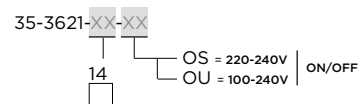
**QR-111**

G53 A+... C	35-3612-14-00	<input type="checkbox"/>	max.100W			220-240V 50-60Hz		09-14
----------------	---------------	--------------------------	----------	--	--	---------------------	--	-------

HIT-T

G12 A+... A	35-3613-14-37	<input type="checkbox"/>	10°	35W		220-240V 50-60Hz
	35-3614-14-37	<input type="checkbox"/>	24°			
	35-3616-14-37	<input type="checkbox"/>	45°			
	35-3617-14-37	<input type="checkbox"/>	10°	70W		
	35-3618-14-37	<input type="checkbox"/>	24°			
	35-3619-14-37	<input type="checkbox"/>	45°			

AR-111 LED

GU10 (max. H=100 mm) A+... A	35-3611-14-00	<input type="checkbox"/>	-	max. 15W		22-25
---------------------------------	---------------	--------------------------	---	----------	--	-------

Accesorios / Accessories / Accessoires / Zubehöre / Accessori / Acessórios / Аксессуары / Akcesoria



ACT-9135-60-00 HIT-T

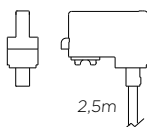

71-3531-60-00

Kit suspensión carril / Track suspended Kit / Kit suspension / Aufhängekit / Kit sospensione / Kit de suspensão / Набор для подвешенного монтажа для шины / Zestaw do zawieszenia

BOND





BOND

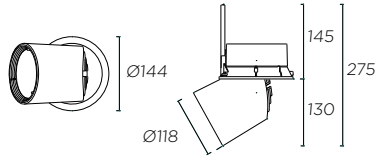

14

AL	IP 20	RF 850°C	0,5M
GLA	60°	320°	DIMMING
DIF			12

M = 71-4894
 P = 71-4897

LED CREE

Zhaga Standard

A**... A

CRI 80

90-4842-14-37	<input type="checkbox"/>	15°	3000K	max. 2670lm	max. 25,9W	max. 700 mA	P.682
90-4843-14-37	<input type="checkbox"/>	24°					
90-4844-14-37	<input type="checkbox"/>	36°					
90-4845-14-37	<input type="checkbox"/>	15°					
90-4846-14-37	<input type="checkbox"/>	24°	4000K				
90-4847-14-37	<input type="checkbox"/>	36°					
90-2582-14-37	<input type="checkbox"/>	15°	3000K	max. 3380lm	max. 33,7W	max. 900 mA	P.682
90-2594-14-37	<input type="checkbox"/>	24°					
90-2599-14-37	<input type="checkbox"/>	36°					
90-2605-14-37	<input type="checkbox"/>	15°					
90-2611-14-37	<input type="checkbox"/>	24°	4000K				
90-2613-14-37	<input type="checkbox"/>	36°					

CRI 90

90-2614-14-37	<input type="checkbox"/>	15°	3000K	max. 2020lm	max. 25,9W	max. 700 mA	P.682
90-2615-14-37	<input type="checkbox"/>	24°					
90-2616-14-37	<input type="checkbox"/>	36°					
90-3512-14-37	<input type="checkbox"/>	15°					
90-3513-14-37	<input type="checkbox"/>	24°	4000K	max. 2750lm	max. 33,7W	max. 900 mA	P.682
90-3514-14-37	<input type="checkbox"/>	36°					

LED 3000K 33,7W 24°

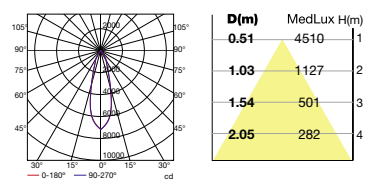

Accesorios necesarios / Accessories required / Accessoires nécessaires / Notwendig Zubehör / Accessori necessari / Acessórios necessários / Необходимые аксессуары / Akcesoria konieczne

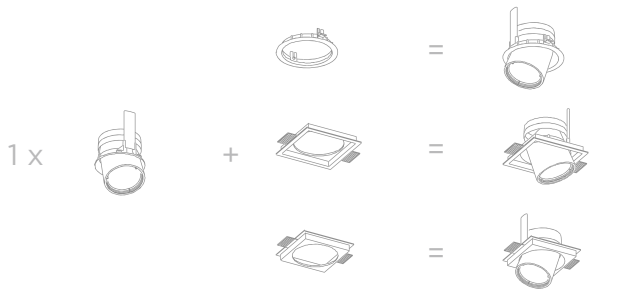

71-2337-14-00



71-2339-14-00

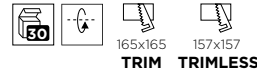

71-2338-14-00



71-2340-14-00

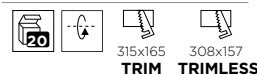



BOND

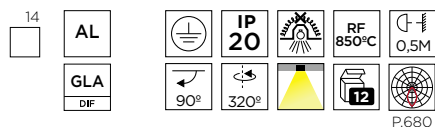
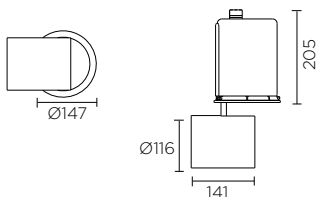

QR-111

G53
A**... C

71-1929-14-00	<input type="checkbox"/>	max.100W		09-14
---------------	--------------------------	----------	--	-------

CDM-R111

GX8.5
A**... C

71-1849-14-00	<input type="checkbox"/>	max.70W		15-20
---------------	--------------------------	---------	--	-------

HIT-T

G12
A*... A

71-1930-14-37	<input type="checkbox"/>	10°	max.70W	
71-1931-14-37	<input type="checkbox"/>	24°		
71-1932-14-37	<input type="checkbox"/>	45°		

Accesorios / Accessories / Accessoires / Zubehöre / Accessori / Acessórios / Аксессуары / Akcesoria



ACT-9135-60-00 HIT-T

Accesorios necesarios / Accessories required / Accessoires nécessaires / Notwendig Zubehör / Accessori necessari / Acessórios necessários / Необходимые аксессуары / Akcesoria konieczne

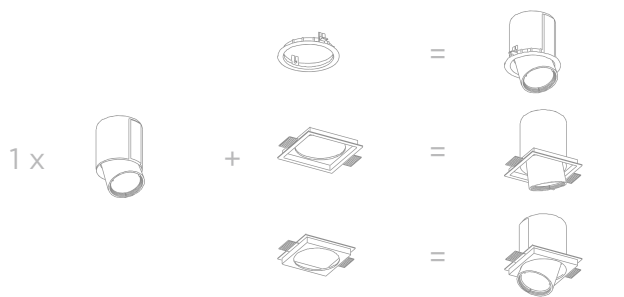

71-2337-14-00	<input type="checkbox"/>		
50 Ø 170			



71-2339-14-00	<input type="checkbox"/>		
50 165x165 157x157			
TRIM TRIMLESS			

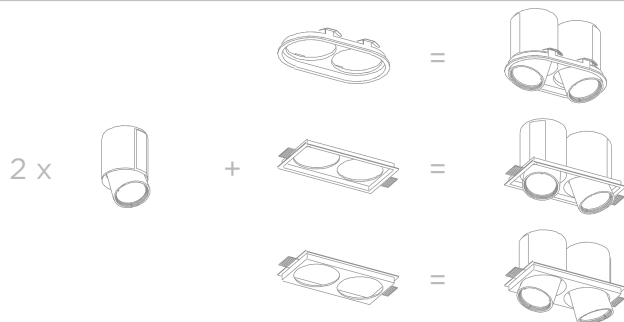

71-2338-14-00	<input type="checkbox"/>		
20 320x170			



71-2340-14-00	<input type="checkbox"/>		
20 315x165 308x157			
TRIM TRIMLESS			



ACTION







ACTION FOOD

NEW

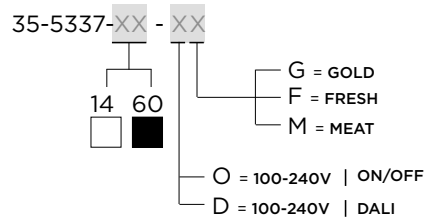
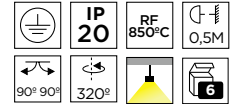
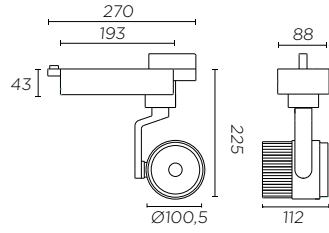

LED TRIDONIC

A**... A

	XX	XX				
35-5337	-	14	OG DG	GOLD	3760 lm	36,9W
		60	OF DF	FRESH	3550 lm	
			OM DM	MEAT	2450 lm	

	 Dorados Golden		G = GOLD TC: 2700K IRC:85
	 Diversidad de colores Multiple colours		F = FRESH TC: 3000K IRC:98
	 Rojos y rosados Red and pink		M = MEAT TC: 3000K IRC:85







ACTION

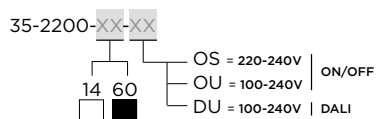
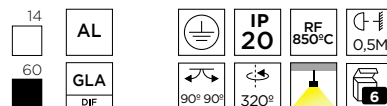
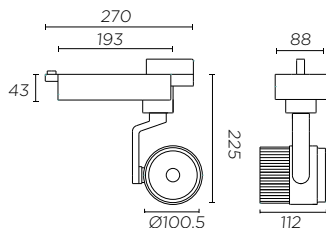

LED CREE

CRI 80

A**... A

	XX	XX						
35-3931	14	OS	10°	3000K	2180 lm	25,1W		
35-3932	60	OU		4000K				
35-2200	14 60	OS	24°	3000K	3460 lm	38,6W		
35-2202		OU	38°					
35-2204		DU	24°	4000K				
35-2205			38°					
35-3908	14 60	OU	24°	3000K	4600 lm	44,8W		
35-3909			38°					
35-3910			24°	4000K				
35-3911			38°					

CRI 90

35-3933	14	OS	10°	3000K	1760 lm	25,1W		
35-2210	60	OU	24°		2020 lm	25,9W		
35-2215			38°					
35-3510	14	OS	24°	3000K	2960 lm	38W		
35-3511	60	OU	38°					
35-3912	14	OU	24°	3000K	3490 lm	44,8W		
35-3913	60		38°					

LED 3000K 25,1W 10°

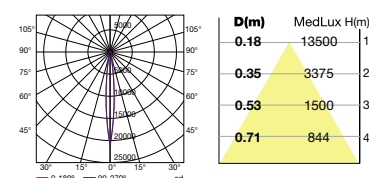

Accesorios / Accessories / Accessoires / Zubehöre / Accessori / Acessórios / Аксессуары / Akcesoria



71-2675-60-00

ACTION HIGH DEFINITION OPTIC CONTROL

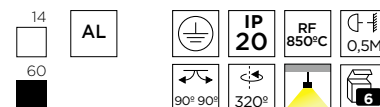
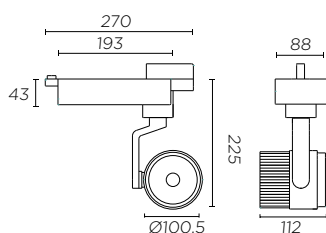

LED CREE

CRI 93

A**... A

35-5153	14	OU	11°	3000K	1800 lm	25,1W		
35-5153	60							

ACTION

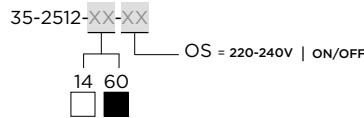
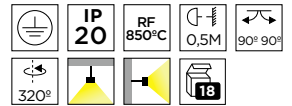
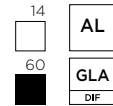
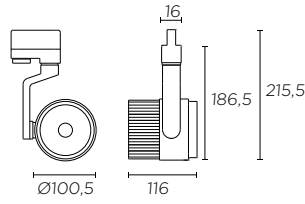

LED OSRAM

CRI 80

XX XX

A**... A

35-2512	14 60	OS	24°	3000K	2000 lm	25,7W	
35-2515			38°			24,4W	
35-2513			24°	4000K			
35-2517			38°				

LED 3000K 25,7W 24°

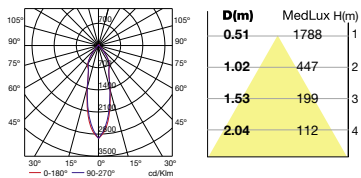

LED 3000K 25,7W 38°

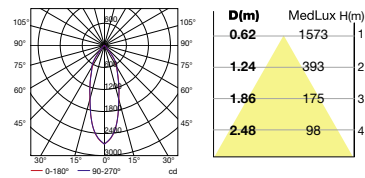

Accesorios / Accessories / Accessoires / Zubehöre / Accessori / Acessórios / Аксессуары / Akcesoria



71-2675-60-00



ACT-9105-14-00



ACT-9105-60-00



ACT-9106-14-00



ACT-9106-60-00



+

ACT-9105-14-00



ACT-9105-60-00





ACTION

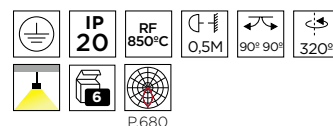
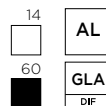
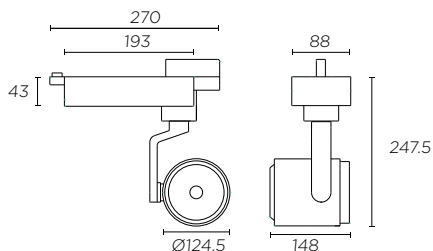

QR-111

G53 A*... C	PR-0946-14-00 <input type="checkbox"/>	max.100W	220-240V 50-60Hz	09-14
	PR-0946-60-00 <input checked="" type="checkbox"/>			

HIT-T

G12 A*... A	PR-0949-14-37 <input type="checkbox"/>	12°	35W	220-240V 50-60Hz
	PR-0949-60-37 <input checked="" type="checkbox"/>			
	PR-0950-14-37 <input type="checkbox"/>	24°		
	PR-0950-60-37 <input checked="" type="checkbox"/>			
	PR-0951-14-37 <input type="checkbox"/>	38°		
	PR-0951-60-37 <input checked="" type="checkbox"/>			
	PR-0952-14-37 <input type="checkbox"/>	12°	70W	
	PR-0952-60-37 <input checked="" type="checkbox"/>			
	PR-0953-14-37 <input type="checkbox"/>	24°		
	PR-0953-60-37 <input checked="" type="checkbox"/>			
PR-0954-14-37 <input type="checkbox"/>	38°			
PR-0954-60-37 <input checked="" type="checkbox"/>				

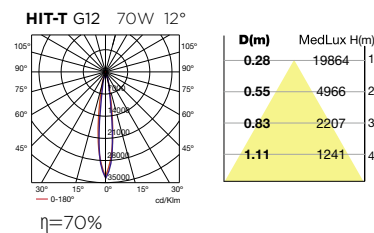

AR-111 LED

GU10 (max. H=100 mm) A*... A	PR-0955-14-00 <input type="checkbox"/>	max. 15W	-	22-25
	PR-0955-60-00 <input checked="" type="checkbox"/>			

Accesorios / Accessories / Accessoires / Zubehöre / Accessori / Acessórios / Аксессуары / Akcesoria



ACT-9180-60-00 HIT-T



ACT-9181-14-00

HIT-T

ACT-9181-60-00

QR-111

AR-111





ACTION WALL WASHER

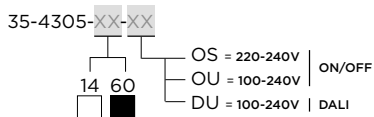
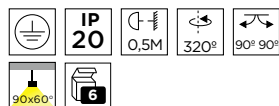
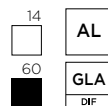
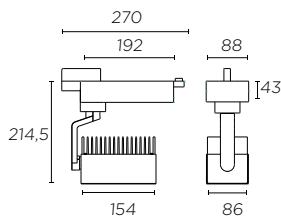

LED CREE
Zhaga Standard
A**... A

	CRI80	XX	XX				
35-4305	-	14	OS	3000K	3460 lm	38,6W	
35-4306		60	OU DU	4000K			
35-4731	-	14	OU	3000K	5120 lm	53,2W	
35-4732		60		4000K			
35-4313	-	14	OS	3000K	2960 lm	38W	
35-4733		60	OU	3000K			

LED 3000K 38,6W 90°x60°

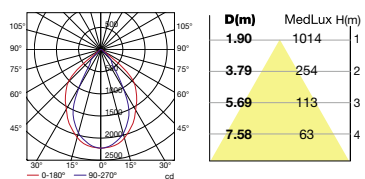

LED 3000K 53,2W 90°x60°

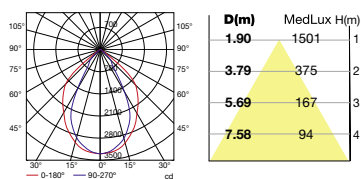

MACH3
MINI

MACH3
MEDIUM



MACH3



MACH3 MINI

NEW

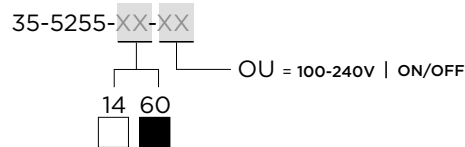
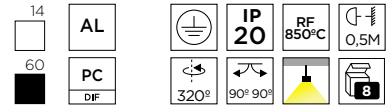
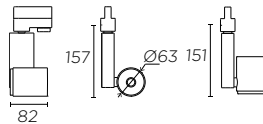

LED CREE	CRI 80	XX	XX				
A**... A				15°			
		14		28°	3000K		
				40°		1180 lm	10,7W
			OU	15°			
		60		28°	4000K		
				40°			
	CRI 90			15°			
		14		28°	3000K	1020 lm	10,7W
		60	OU	40°			

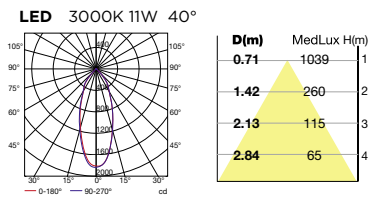

Accesorios / Accessories / Accessoires / Zubehöre / Accessori / Acessórios / Аксессуары / Akcesoria



71-5204-60-00



71-5205-60-00

Confort visual/ Visual comfort/
Confort visuel/ Sichtkomfort/
Comfort visivo/ Conforto visual/
Визуальный комфорт/ Komfort wizualny



ACT-9105-14-00



ACT-9105-60-00



ACT-9106-14-00



ACT-9106-60-00



+

ACT-9105-14-00



ACT-9105-60-00



MACH3 MEDIUM

NEW

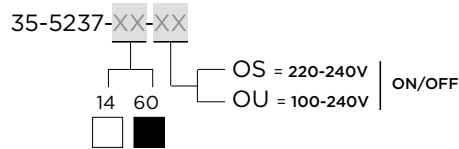
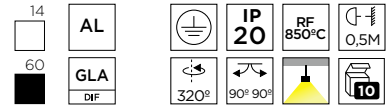
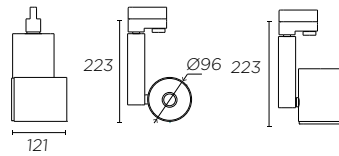

LED CREE

CRI 80

Zhaga Standard

A+... A

Model	Height	Beam	Temp	Color	LM	W	Energy
35-5237	14	OS	20°	3000K	2670 lm	25,9W	
35-5238			35°				
35-5239			55°				
35-5240		OU	20°				
35-5241			35°				
35-5242			55°				
35-5246	60	OU	20°	3000K	3220 lm	34,3W	
35-5247			35°				
35-5248			55°				
35-5249		OU	20°				
35-5250			35°				
35-5251			55°				

CRI 90

35-5243	14	OS	20°	3000K	2020 lm	25,9W	
35-5244			35°				
35-5245		55°					
35-5252	60	OU	20°	3000K	2750 lm	33,7W	
35-5253			35°				
35-5254			55°				

Accesorios / Accessories / Accessoires / Zubehöre / Accessori / Acessórios / Аксессуары / Akcesoria



71-5201-60-00



71-5202-60-00

Confort visual/ Visual comfort/
Confort visuel/ Sichtkomfort/
Confort visivo/ Conforto visual/
Визуальный комфорт/ Komfort
wizualny



ACT-9105-14-00



ACT-9105-60-00



ACT-9106-14-00



ACT-9106-60-00



+

ACT-9105-14-00



ACT-9105-60-00





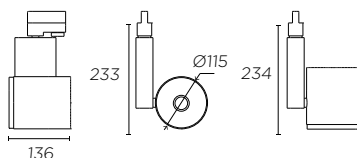

MACH3

**LED CREE**
Zhaga Standard
A**... A**CRI 80**

XX XX

35-3934			15°	3000K	3460 lm	38,6W	
35-3935	14	OS	30°				
35-3936	-	OU	55°				
35-3937			15°	4000K			
35-3938	60	DU	30°				
35-3939			55°				
35-3943			15°	3000K	5120 lm	53,2W	
35-3944	14		30°				
35-3945	-	OU	55°				
35-3946			15°	4000K			
35-3947	60		30°				
35-3948			55°				

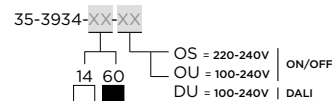
**CRI 90**

35-3940			15°	3000K	2960 lm	38W	
35-3941	14	OS	30°				
35-3942	-	OU	55°				
35-3949			15°	4000K	3880 lm	53,2W	
35-3950	60	OU	30°				
35-3951			55°				

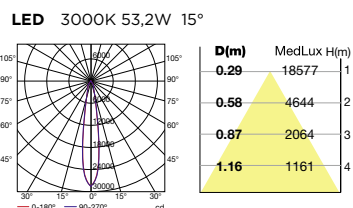

Accesorios / Accessories / Accessoires / Zubehöre / Accessori / Acessórios / Аксессуары / Akcesoria



71-3896-60-00



ACT-9105-14-00



ACT-9105-60-00



ACT-9106-14-00



ACT-9106-60-00



+

ACT-9105-14-00



ACT-9105-60-00



71-3897-60-00

Confort visual/ Visual comfort/
Confort visuel/ Sichtkomfort/
Confort visivo/ Conforto visual/
Визуальный комфорт/ Komfort
wizualny

MACH3 OPTIC CONTROL

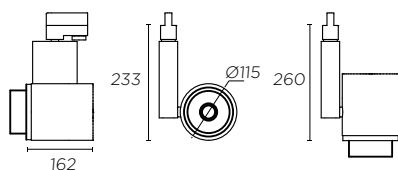
**LED PHILIPS CRISP WHITE**

Zhaga Standard

A**... A

CRI 92

35-5150-14-OU		19°	3000K	3800lm	42W	
35-5150-60-OU						





KEY

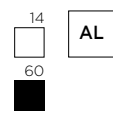
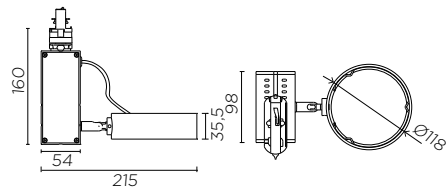

QR-111

G53	35-1559-14-00	<input type="checkbox"/>	max.100W		09-14
A**... C	35-1559-60-00	<input checked="" type="checkbox"/>			

CDM-R111

GX8.5	35-1557-14-00	<input type="checkbox"/>	35W		15-20
	35-1557-60-00	<input checked="" type="checkbox"/>			
A**... C	35-1558-14-00	<input type="checkbox"/>	70W		
	35-1558-60-00	<input checked="" type="checkbox"/>			



AR-111 LED

GU10	35-1565-14-00	<input type="checkbox"/>	max. 15W	-	
A**... A	35-1565-60-00	<input checked="" type="checkbox"/>			

KEY

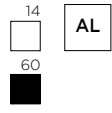
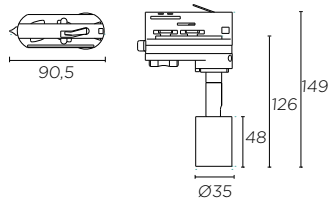

AR-111 /QPAR-16

GU10	35-2898-14-00	<input type="checkbox"/>	max.75W	-	-	
A**... C	35-2898-60-00	<input checked="" type="checkbox"/>				

Accesorios / Accessories / Accessoires / Zubehöre / Accessori / Acessórios / Аксессуары / Akcesoria

	ACT-9105-14-00	<input type="checkbox"/>			ACT-9106-14-00	<input type="checkbox"/>	
	ACT-9105-60-00	<input checked="" type="checkbox"/>			ACT-9106-60-00	<input checked="" type="checkbox"/>	
+							
	ACT-9105-14-00	<input type="checkbox"/>			ACT-9105-60-00	<input checked="" type="checkbox"/>	

CARRILES / TRACKS

TRIMLESS

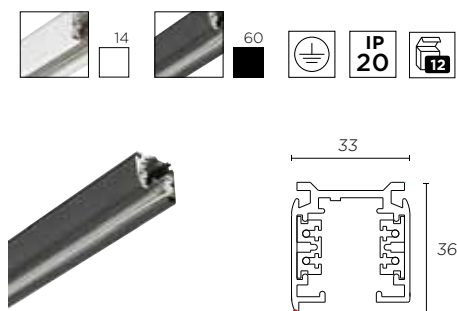

71-5210-14-00	<input type="checkbox"/>	2000 mm	DALI	Carril trifásico Three-circuit track Rail triphasé 3-Phasen-Schiene Binario trifásico Calha trifásico Трёхфазный шинопровод Trójfazowa szyna
71-5210-60-00	<input checked="" type="checkbox"/>			
71-5464-14-00	<input type="checkbox"/>			
71-5464-60-00	<input checked="" type="checkbox"/>			
71-5211-14-00	<input type="checkbox"/>	3000 mm	DALI	
71-5211-60-00	<input checked="" type="checkbox"/>			
71-5465-14-00	<input type="checkbox"/>			
71-5465-60-00	<input checked="" type="checkbox"/>			

TRIM

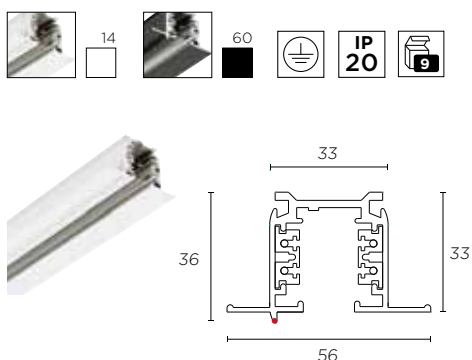

71-5213-14-00	<input type="checkbox"/>	2000 mm	DALI	Carril trifásico para montaje empotrado Three-circuit track for recessed mounting Rail électrifié triphasé à montage encastré 3-Phasen-Schiene Einbau Binario trifásico per montaggio ad incasso Calha trifásica para montagem encastrada Трёхфазный шинопровод для встроенного монтажа Trójfazowa szyna do wbudowania
71-5213-60-00	<input checked="" type="checkbox"/>			
71-5466-14-00	<input type="checkbox"/>			
71-5466-60-00	<input checked="" type="checkbox"/>			



ACT-9165-48-00
1m= 1 kit / 2m= 2 kits

Kit para empotrar (2 unidades/ref)
Recessed kit (2 units/ref)
Kit d'encastrement (2 unités/réf)
Einbaukit (2 Stk/Ref)
Kit per incasso (2 unità/rif)
Kit para encastrar (2 unidades/ref)
Набор для встроенного монтажа (2 шт/артикул)
Zestaw do wbudowania (2 sztuki/ref.)

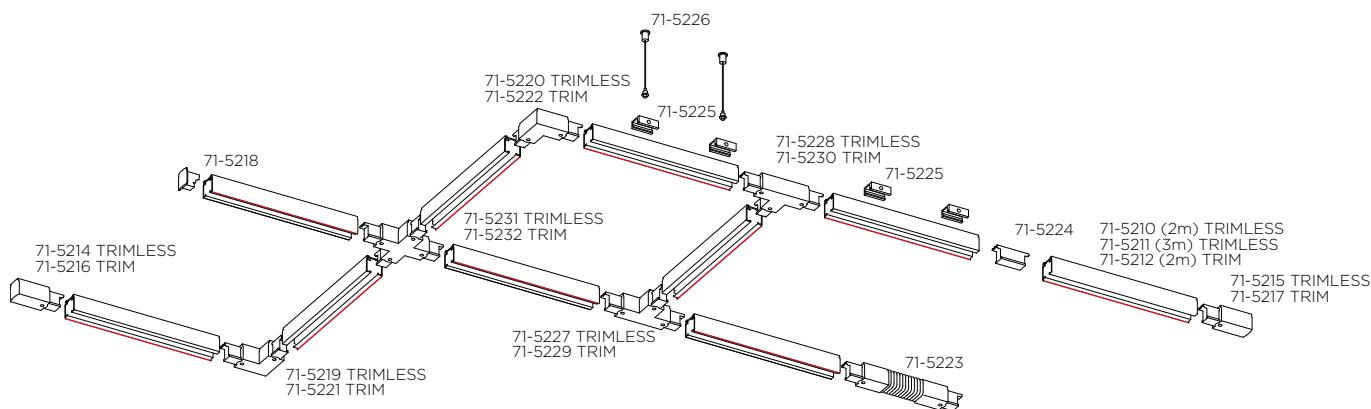

Elementos de fijación y accesorios / Installation accessories / Éléments de fixation et accessoires / Befestigungselemente und Zubehör / Elementi di fissaggio e accessori / Elementos de fixaçao e acessórios / Elementy mocujące i akcesoria / Крепеж и аксессуары



71-5225-14-00
71-5225-60-00

Para piezas de fijación directa a falsos techos /
For direct mounting on false ceilings /
Destiné à la fixation directe sur faux plafonds /
Für Teile zur direkten Befestigung an Zwischendecken /
Per l'installazione diretta su controsoffitti /
Para fixaçao direta a tectos falsos /
Для светильников, монтируемых непосредственно в
подвесные потолки /
Dla elementów bezpośrednio mocowanych do podwieszanych
sufitów /

4 unidades/ref / 4 units/ref / 4 unités/ref / 4 Stk/ref
/ 4 unità/rif / 4 unidades/ref / 4 штуки/артикул / 4
sztuki/ref.



ACT-9090-14-00 ON / OFF
ACT-9090-N3-00 ON / OFF
ACT-9083-N3-00 DALI

Suspensión con toma de corriente /
Suspension with mains supply /
Suspension avec prise d'alimentation /
Aufhängung mit Stromanschluss /
Sospensione con presa di corrente /
Suspensão com tomada de corrente /
Подвесной монтаж с включением в сеть /
Zawieszenie z elementem zasilającym prądu /









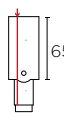
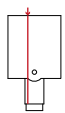
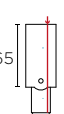
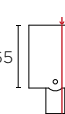

71-5226-21-00

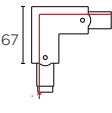
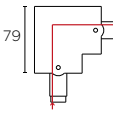
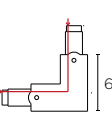
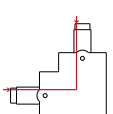
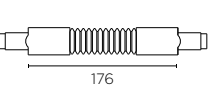
Sirga de acero / Steel cable / Câble de suspension
en acier / Stahlkabel / Cavo in acciaio / Cabo
de suspensão em aço / Подвесной монтаж
(1.300mm) / Stalowa lina

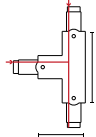
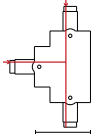
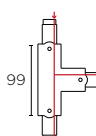
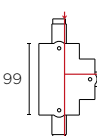
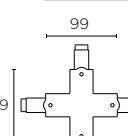
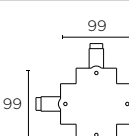
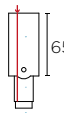
2 unidades/ref / 2 units/ref / 2 unités/ref / 2
Stk/ref / 2 unità/rif / 2 unidades/ref / 2 штуки/
артикул / 2 sztuki/ref.

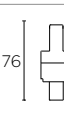
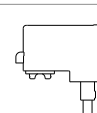

TRIMLESS	TRIM						
		71-5214	14	-	00	TRIMLESS	Acometida derecha / Mains connector (right) / Connecteur d'alimentation droit / Anschluss rechts / Allacciamento destro / Conector de alimentação direito / Токопровод правый / Prawe zasilanie
		71-5216	60	-		TRIM	
		71-5215	14	-	00	TRIMLESS	Acometida izquierda / Mains connector (left) / Connecteur d'alimentation gauche / Anschluss links / Allacciamento sinistro / Conector de alimentação esquerdo / Токопровод левый / Lewe zasilanie
		71-5217	60	-		TRIM	
		71-5218	14	-	00	TRIMLESS / TRIM	Tapa final / End cap / Cache final / Endkappe / Cappuccio finale / Топо final / Торцевая заглушка / Záslepka
		71-5219	14	-	00	TRIMLESS	Conector "L" derecho / Right "L" connector / Connecteur « L » droit / L-Stecker rechts / Connettore "L" destro / Conetor "L" direito / Подсоединение в форме "L" справа / Prawy łącznik "L"
		71-5221	60	-		TRIM	
		71-5220	14	-	00	TRIMLESS	Conector "L" izquierdo / Left "L" connector / Connecteur « L » gauche / L-Stecker links / Connettore "L" sinistro / Conetor "L" esquerdo / Подсоединение в форме "L" слева / Lewy łącznik "L"
		71-5222	60	-		TRIM	
		71-5223	14	-	00	TRIMLESS / TRIM	Conector flexible / Flexible Connector / Connecteur flexible / Flexibler Stecker / Connettore flessibile / Conetor flexível / Гибкое подсоединение / łącznik giętki
		71-5224	14	-	00	TRIMLESS / TRIM	Conector continuidad / Straight connector / Connecteur de continuité / Stecker Durchgängigkeit / Connettore di continuità / Conector de continuidade / Токопровод центральный / Złączka liniowa
		71-5227	14	-	00	TRIMLESS	Conector "T" derecho / "T" connector right / Connecteur en « T » droit / T-Stecker rechts / Conector "T" direito / Connettore a "T" destro / Токопровод T-образный правый / Prawa złączka w kształcie T
		71-5229	60	-		TRIM	
		71-5228	14	-	00	TRIMLESS	Conector "T" izquierdo / "T" connector left / Connecteur en « T » gauche / T-Stecker links / Connettore a "T" sinistro / Conector "T" esquerdo / Токопровод T-образный левый / Lewa złączka w kształcie T
		71-5230	60	-		TRIM	
		71-5231	14	-	00	TRIMLESS	Conector "X" / "X" connector / Connecteur en « X » / X-Stecker links / Connettore a "X" / Conector "X" / Токопровод X-образный левый / Lewa złączka w kształcie "X"
		71-5232	60	-		TRIM	
		71-5420	14	-	00	TRIMLESS	DALI Acometida derecha / Mains connector (right) / Connecteur d'alimentation droit / Anschluss rechts / Allacciamento destro / Conector de alimentação direito / Токопровод правый / Prawe zasilanie
		71-5422	60	-		TRIM	
		71-5421	14	-	00	TRIMLESS	DALI Acometida izquierda / Mains connector (left) / Connecteur d'alimentation gauche / Anschluss links / Allacciamento sinistro / Conector de alimentação esquerdo / Токопровод левый / Lewe zasilanie
		71-5424	60	-		TRIM	
		71-2232	14-14	-	60-60	TRIMLESS / TRIM	Conector de carril / Track connector / Connecteur de rail / Schienenstecker / Collegamento binari / Conector de calha / Соединитель шины / łącznik szyny

TECHNICAL

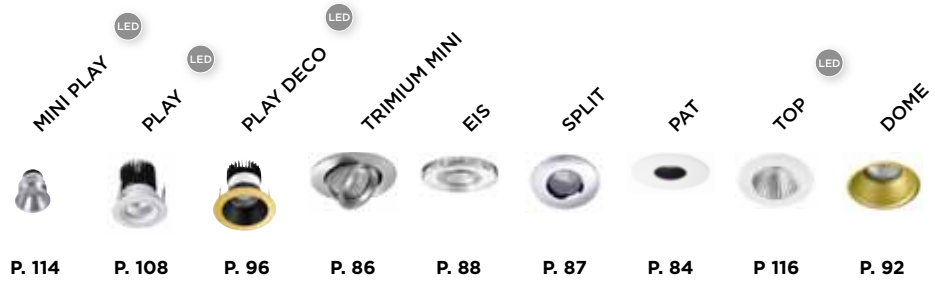

	P. 114	P. 108	P. 96	P. 86	P. 88	P. 87	P. 84	P. 116	P. 92
<Ø 60mm	■	■							
Ø 61-70mm		■		■	■				
Ø 71-80mm		■	■		■	■	■	■	
Ø 81-90mm				■					■
Ø 91-100mm				■					
Ø 111-120mm									■
Ø 121-130mm									
Ø 131-140mm									
Ø 141-150mm									
Ø 151-160mm									
Ø 161-170mm									
Ø 171-180mm									
Ø 181-190mm									
Ø 191-200mm									■
Ø 201-210mm									
Ø 211-220mm									
Ø 221-230mm									
Ø 231-240mm									
QR-111/G53 100W									■
QR-CBC51/GU5.3 50W				■	■	■	■		■
HIT-T/G12									
HIT-TC/G8.5 70W									
G24q 18/26W									
G24d 18/26W									
E-27									
AR-111/GU10									■
MR16/GU5.3				■	■	■	■		■
QPAR16/GU10				■			■		■
LED		Max.3,2W	Max.7/13W	Max.7/13W				5,5W	
LED Zhaga									
Fijo/ Fixed	■	■	■	■	■	■		■	■
Orientable / Adjustable	■	■		■			■		■
IP20									
IP23				■			■		■
IP40									
IP43									
IP44									
IP54	■	■	■		■			■	
IP65						■			



■ (1) ■ (1)

■

TECHNICAL

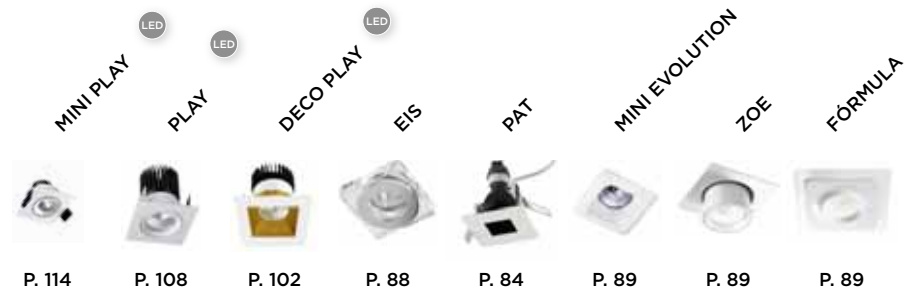

	P. 114	P. 108	P. 102	P. 88	P. 84	P. 89	P. 89	P. 89
<Ø 60mm	■	■						
Ø 61-70mm		■		■				
Ø 71-80mm				■	■	■	■	■
Ø 81-90mm								
Ø 91-100mm			■					
70-90mm x 70-90mm			■					
101-110mm x 101-110mm								
121-130mm x 121-130mm								
151-160mm x 151-160mm								
161-170mm x 161-170mm								
201-210mm x 101-110mm								
201-210mm x 201-210mm								
211-220mm x 211-220mm								
220-240mm x 120-140mm								
251-260mm x 151-160mm								
291-300mm x 151-160mm								
291-300mm x 291-300mm								
301-310mm x 101-110mm								
301-310mm x 151-160mm								
311-320mm x 161-170mm								
311-320mm x 311-320mm								
441-450mm x 151-160mm								
451-460mm x 161-170mm								
591-600mm x 591-600mm								
QR-111/G53								
CDM-R111/GX8.5								
QR-CBC51/GU5.3				■	■	■	■	■
HIT-TC G8.5								
AR-111/GU10								
MR16/GU5.3				■	■	■	■	■
QPAR16/GU10				■	■	■		■
LED		Max.3,2W	Max.7/13W	Max.7/13W				
LED Zhaga								
Fijo/ Fixed	■	■	■	■		■	■	■
Orientable/ Adjustable	■	■			■			
IP20								
IP23					■	■	■	
IP40								
IP44								
IP54	■	■	■	■				
IP65								■



■ (1) ■ (1)



IN

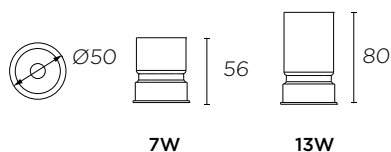

LED CREE

A**... A	71-4032-14-M2	<input type="checkbox"/>	2700K	570lm	7W	-	-			100-240V 50-60Hz
	71-4033-14-M2	<input type="checkbox"/>	3000K	620lm						
	71-3885-14-M2	<input type="checkbox"/>	2700K	max.570lm	max. 7W		max. 700 mA			P.682
	71-3886-14-M2	<input type="checkbox"/>	3000K	max.620lm						

LED CREE NEW

A**... A	71-5156-14-M2	<input type="checkbox"/>	2700K	1240lm	13W	-	-			100-240V 50-60Hz
	71-5157-14-M2	<input type="checkbox"/>	3000K	1330lm						
	71-5086-14-M2	<input type="checkbox"/>	2700K	max.1240lm	max. 13W		max. 350 mA			P.682
	71-5087-14-M2	<input type="checkbox"/>	3000K	max.1330lm						

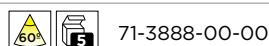
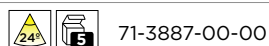
Accesorios / Accessoires / Accessoires / Zubehöre / Accessori / Acessórios / Аксессуары / Акcesoria

EIS
P.88

DOMÉ
P.92

MULTIDIR EVO S
P.142

TRIMIUM MINI
P.86

GES
P.94

PAT
P.84

SPLIT
P.87

FÓRMULA
P.89

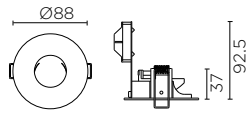

14 AL

IP 23	☀️	🔥	RF 850°C
0,2M	40°	💡	100



GU5.3 / GU10

A++... C

DN-1695-14-00 <input type="checkbox"/>	GU5.3	max.50W	☒ P.691	12V	☒
	GU10		-	-	☐

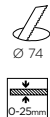
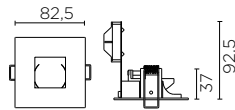

14 AL

IP 23	☀️	🔥	RF 850°C
0,2M	40°	💡	100



GU5.3 / GU10

A++... C

DN-1696-14-00 <input type="checkbox"/>	GU5.3	max.50W	☒ P.691	12V	☒
	GU10		-	-	☐



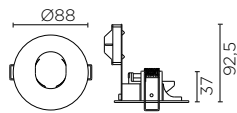

14 AL

IP 23			RF 850°C
0,2M	40°		100



GU5.3 / GU10

A++... C

DN-1697-14-00 <input type="checkbox"/>	GU5.3	max.50W		12V	
	GU10		-	-	

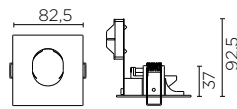

14 AL

IP 23			RF 850°C
0,2M	40°		100



GU5.3 / GU10

A++... C

DN-1698-14-00 <input type="checkbox"/>	GU5.3	max.50W		12V	
	GU10		-	-	

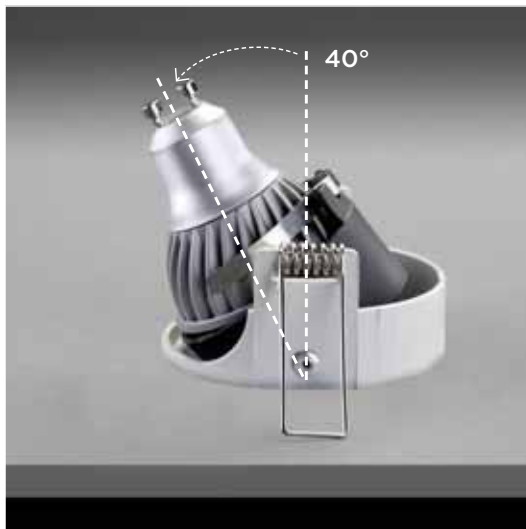

TRIMIUM MINI

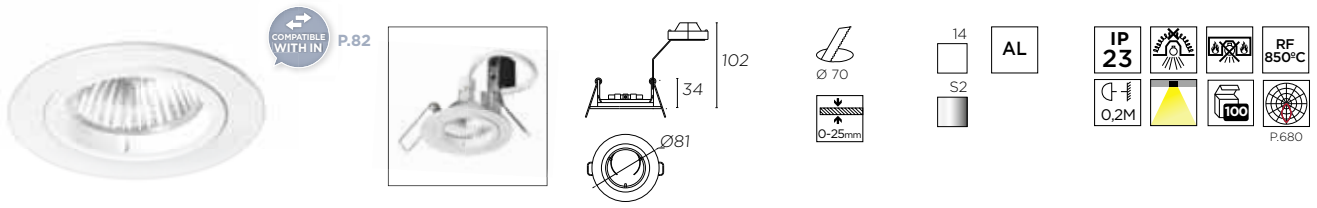

GU5.3



A**... C

DN-0522-14-00	<input type="checkbox"/>	max.50W		12V	
DN-0522-S2-00	<input type="checkbox"/>				

GU10



A**... C

DN-0525-14-00	<input type="checkbox"/>	max.50W	-	-	
DN-0525-S2-00	<input type="checkbox"/>				

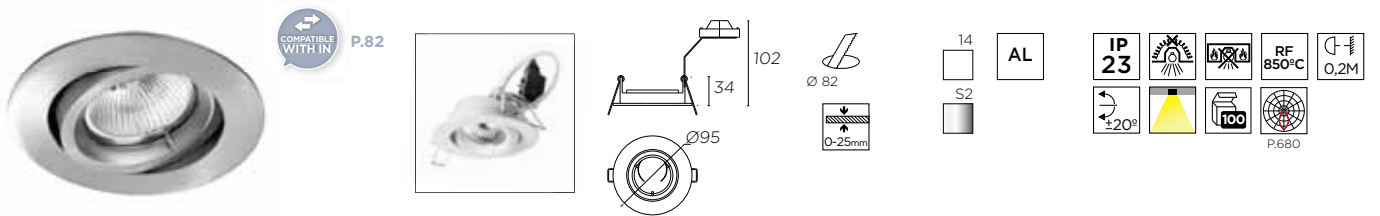

GU5.3



A**... C

DN-0521-14-00	<input type="checkbox"/>	max.50W		12V	
DN-0521-S2-00	<input type="checkbox"/>				

GU10



A**... C

DN-0526-14-00	<input type="checkbox"/>	max.50W	-	-	
DN-0526-S2-00	<input type="checkbox"/>				

TRIMIUM MINI

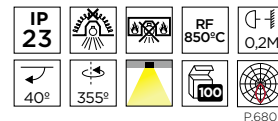
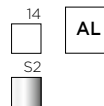
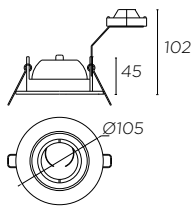

GU5.3 (max. H=50 mm)



A**... C

DN-0520-14-00	<input type="checkbox"/>	max.50W		12V		1-8
DN-0520-S2-00	<input type="checkbox"/>					

GU10 (max. H=57 mm)



A**... C

DN-0527-14-00	<input type="checkbox"/>	max.50W	-	-		21
DN-0527-S2-00	<input type="checkbox"/>					

SPLIT

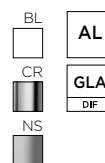
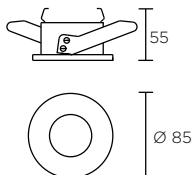

GU5.3

A**... C

320-BL	<input type="checkbox"/>	max.50W		12V		1-8
320-CR	<input type="checkbox"/>					
320-NS	<input type="checkbox"/>					

SPLIT

Accesorios / Accessories / Accessoires / Zubehöre / Accessori / Acessórios / Аксессуары / Akcesoria

71-4396-00-00	Kit GU10
---------------	----------

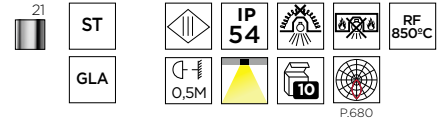

GU5.3

A**... C

90-1689-21-37		max.50W		12V	
---------------	--	---------	--	-----	--



GU5.3

A**... C

90-1690-21-37		max.50W		12V	
---------------	--	---------	--	-----	--



GU5.3

A**... C

90-1792-21-37		max.50W		12V	
---------------	--	---------	--	-----	--

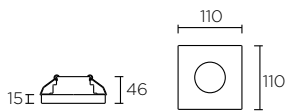

GU5.3

A**... C

90-1789-21-37		max.50W		12V	
---------------	--	---------	--	-----	--

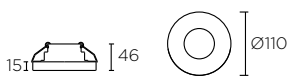

EIS

Accesorios / Accessories / Accessoires / Zubehöre / Accessori / Acessórios / Аксессуары / Akcesoria

71-4396-00-00	Kit GU10
---------------	----------

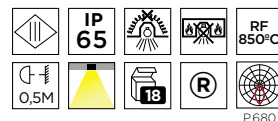
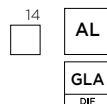
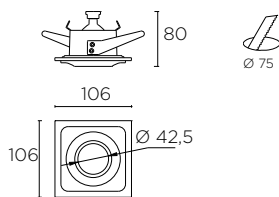

GU5.3

A**... C

90-4349-14-B9	<input type="checkbox"/>	max.50W		12V	
---------------	--------------------------	---------	--	-----	--

FÓRMULA

Accesorios / Accessories / Accessoires / Zubehöre / Accessori / Acessórios / Аксессуары / Акcesoria

71-4396-00-00	Kit GU10
---------------	----------

ZOE

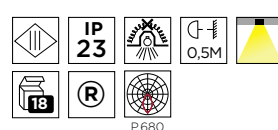
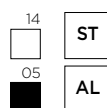
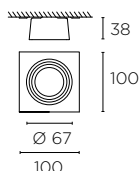

GU5.3 (max. H=50 mm)

A**... C

90-4350-05-05	<input checked="" type="checkbox"/>	max.50W		12V	
90-4350-14-14	<input type="checkbox"/>				



2 aros de colores incluidos
 2 coloured rings included
 2 anneaux de couleur fournis
 2 farbigeRinge inklusive
 2 anelli colorati inclusi
 2 aros coloridos incluidos
 В комплект входят 2 цветных кольца
 Obście w 2 kolorach w komplecie

MINI EVOLUTION

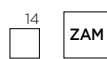
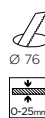
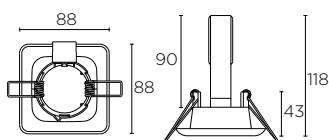

GU5.3 / GU10

A**... C

DM-1107-14-00	<input type="checkbox"/>	GU5.3	max.50W		12V		
		GU10		-	-		



MINI

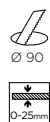
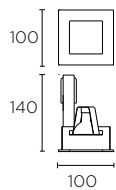

GU10 (max. H=57 mm)

A**... C

DM-1106-N3-00



max.50W

-

-



ACT-FLL-028





DOME

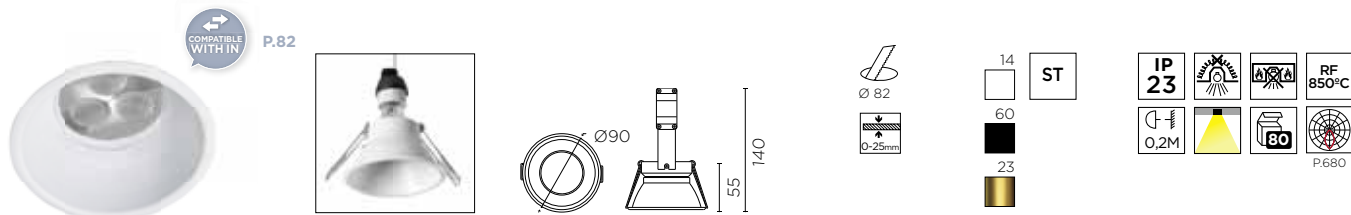

*Incluye anillo invisible para bombilla led / It includes led invisible ring / Comprend un anneau invisible pour led / Inkl. unsichtbarem Ring für led / Include anello invisibile per il led / Inclui anel invisível para led / Содержит невидимое кольцо для светодиода / Zawiera niewidoczny pierścień dla led

GU5.3 / GU10

A**... C

DN-1600-14-00V1 <input type="checkbox"/>	GU5.3	max.50W		12V			1-8
DN-1600-60-00V1 <input checked="" type="checkbox"/>			-	-			21
DN-1600-23-00V1 <input checked="" type="checkbox"/>	GU10		-	-			21

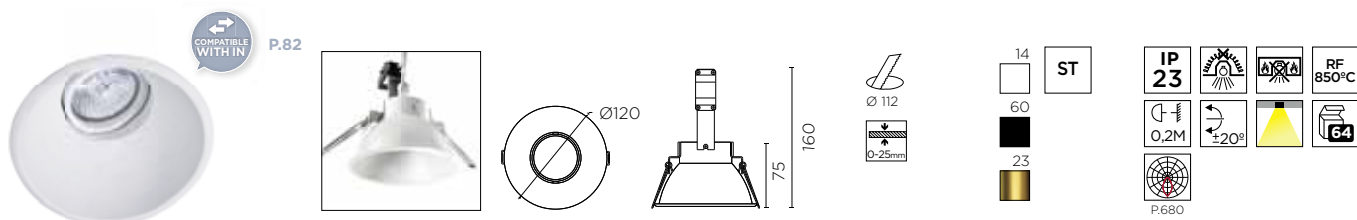

*Incluye anillo invisible para bombilla led / It includes led invisible ring / Comprend un anneau invisible pour led / Inkl. unsichtbarem Ring für led / Include anello invisibile per il led / Inclui anel invisível para led / Содержит невидимое кольцо для светодиода / Zawiera niewidoczny pierścień dla led

GU5.3 / GU10

A**... C

DN-1601-14-00V1 <input type="checkbox"/>	GU5.3	max.50W		12V			1-8
DN-1601-60-00V1 <input checked="" type="checkbox"/> NEW			-	-			21
DN-1601-23-00V1 <input checked="" type="checkbox"/> NEW	GU10		-	-			21

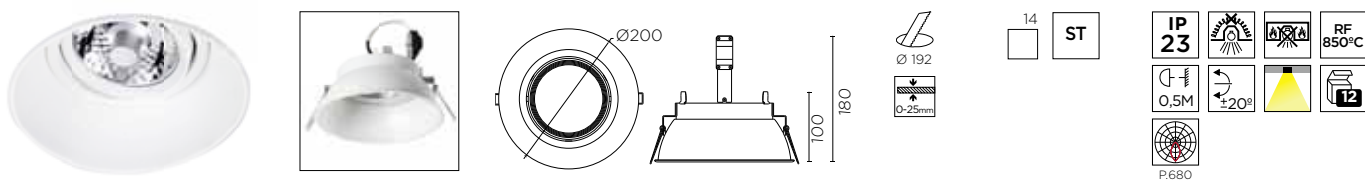

G53 / GU10

A**... C



ACT-FLL-032

DN-1602-14-00V1 <input type="checkbox"/>	G53	max.100W		12V			9-14 / 22-25
	GU10		-	-			22-25

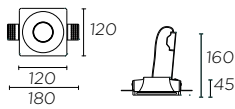

90-2902-14-00

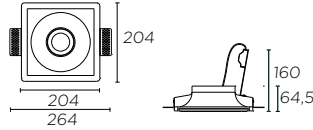

90-2903-14-00

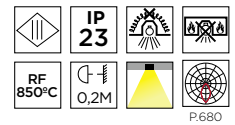
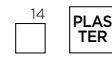

GU5.3

A**... C

90-2902-14-00



max. 35W



12V

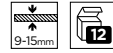
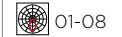

P.691



GU5.3

A**... C

90-2903-14-00



max. 50W



12V

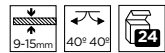
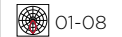

P.691

Accesorios / Accessories / Accessoires / Zubehöre / Accessori / Acessórios / Аксессуары / Akcesoria

71-1881-00-00	Kit GU10
---------------	----------



Se recomienda el uso de un sellador flexible para evitar posibles fisuras y/o la acumulación de suciedad.
 It is recommended that a flexible sealant is used to prevent potential cracks and/or build-up of dirt.
 Il est conseillé d'utiliser un produit d'étanchéité flexible pour éviter d'éventuelles fissures et/ou l'accumulation d'impuretés.
 Es wird empfohlen, eine flexible Dichtung zu verwenden, um mögliche Risse und/oder die Ansammlung von Schmutz zu vermeiden.
 Raccomandiamo l'uso di un collante flessibile onde evitare possibili crepature e/o l'accumulazione di sporcizia.
 Recomenda-se que a junta de se faça com material flexível para evitar possíveis fissuras e/ou acumulação de sujidade.
 Рекомендуется использовать мягкий герметик для избежания трещин и загрязнений.
 Zaleca się użycie elastycznego środka uszczelniającego dla uniknięcia ewentualnych szczelin i/lub gromadzenia się brudu.

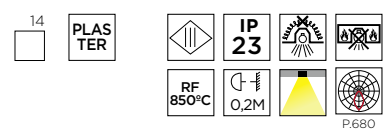
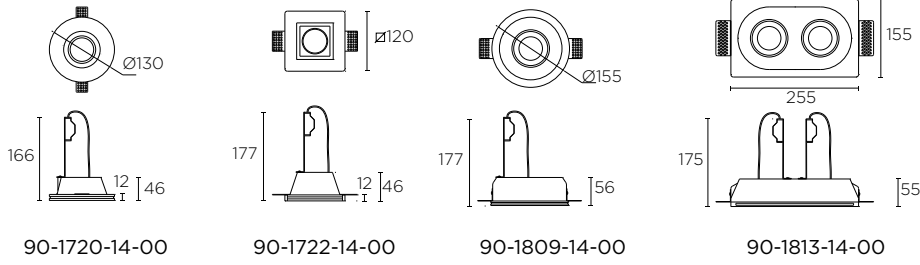

GU5.3

A++... C



90-1720-14-00



max. 35W



12V

01-08



GU5.3

A++... C



90-1722-14-00



max. 35W



12V

01-08



GU5.3

A++... C

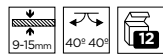

90-1809-14-00



max. 50W



12V

01-08



GU5.3

A++... C

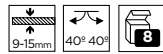

90-1813-14-00



max. 50W



12V

01-08

Accesorios / Accessories / Accessoires / Zubehöre / Accessori / Acessórios / Аксессуары / Akcesoria

71-1881-00-00

Kit GU10



PLAY DECO ROUND



WALLWASHER



PLAY DECO ROUND









PLAY DECO ROUND

					
7W 40° CRI 80 max.660lm 2700/3000/4000K *EMERGENCY	13W 40° CRI 80 max.1330lm 2700/3000/4000K *EMERGENCY	CRI93 13W 40° CRI 93 940lm 2700K	WARM DIMMING 13W 40° CRI 90 930lm 2000-3000K	88 - 145 88 - 133	71-5454-60-00 Adaptador / Adapter / Adaptateur / Adapter / Adattatore / Adaptador / Адаптер / Przystawka GU10 LED
*EMERGENCY: see page 112					PC

					
71-3283-00-00  	71-3284-00-00  	71-5208-00-00  	71-5166-60-00 Panel de abeja / Honeycomb / Panneau en nid d'abeille / Wabentafel / Pannelo a nido d'ape / Favo de abelha / Панель в виде сот / Plaster pszczeli	71-5167-00-00 Difusor elíptico / Elliptical Diffuser / Diffuseur elliptique / Elliptischer Diffusor / Diffusore ellittico / Difusor elíptico / Эллиптический рассеиватель / Dyfuzor eliptyczny	71-4754-60-00 Confort visual/ Visual Comfort/ Confort visuel/ Sichtkomfort/ Confort visivo/ Conforto visual/ Визуальный комфорт/ Komfort wizualny
					PC  

PC		PC	
			
			
	71-4752-14-00V1		71-4753-14-00V1
	71-4752-23-00V1		71-4753-23-00V1
	71-4752-60-00V1		71-4753-60-00V1

   AL IP 54	   ST IP 54
	
	71-5126-14-00 Trimless
	
	127
	

PLAY DECO ROUND

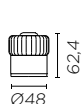

7W

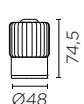

13W

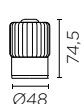

CRI93

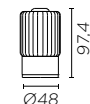

WARM
DIMMING

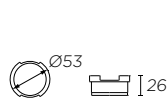

GU10 LED
ADAPTER

14



LED CREE CRI80

A**... A	Model	Color Temp.	Beam Angle	Power	Dimming	Max. Current	Icons
	71-4030-14-37	2700K	570lm	7W	-	-	
	71-2909-14-37V1	3000K	620lm				
	71-5158-14-37	4000K	660lm				
	71-3878-14-37	2700K	max. 570lm	max.7W			
	71-3225-14-37	3000K	max. 620lm				
	71-5130-14-37	4000K	max. 660lm				



LED CREE CRI80

A**... A	Model	Color Temp.	Beam Angle	Power	Dimming	Max. Current	Icons
	71-4031-14-37	2700K	1240lm	13W	-	-	
	71-3226-14-37V1	3000K	1330lm				
	71-5159-14-37	4000K					
	71-3881-14-37	2700K	max. 1240lm	max.13W			
	71-3882-14-37	3000K	max.1330lm				
	71-5131-14-37	4000K					
	71-5256-14-37	2700K	940lm	13W	-	-	
	71-5165-14-37			max.13W			



WARM DIMMING LED SHARP CRI90

A**... A	Model	Color Temp.	Beam Angle	Power	Dimming	Max. Current	Icons
	71-5236-14-37	2000K - 3000K	930lm	13W		-	

WARM DIMMING 2000 - 3000K

La tecnología LED WARM DIMMING proporciona una curva de regulación equivalente a la de una fuente incandescente. LED WARM-DIMMING technology offers a regulation curve equivalent to the one in an incandescent source.

La technologie LED WARM-DIMMING offre une courbe de réglage équivalente à celle d'une source à incandescence.

Die LED-Technologie „Warm Dimming“ bietet eine Regulierungskurve die zu der von Glühlampen äquivalent ist.

La tecnologia LED WARM DIMMING offre una curva di regolazione equivalente a quella di una fonte incandescente.

A tecnologia LED WARM-DIMMING proporciona uma curva de regulação equivalente à de uma fonte incandescente.

Светодиодная технология WARM-DIMMING (DT) позволяет регулировать яркость свечения, имитируя свет лампы накаливания.

Technologia LED WARM-DIMMING dostarcza krzywej regulacyjnej odpowiadającej tej źródła żarowego.

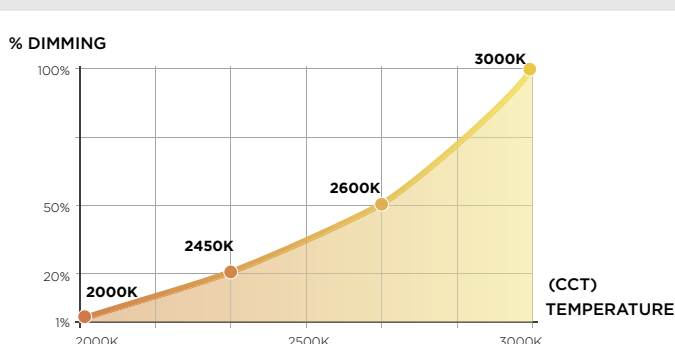



PLAY DECO SQUARE









WALLWASHER



PLAY DECO SQUARE

						
7W 40° CRI 80 max.660lm 2700/3000/4000K	13W 40° CRI 80 max.1330lm 2700/3000/4000K	CRI93 13W 40° CRI 93 940lm 2700K	WARM DIMMING 13W 40° CRI 90 930lm 2000-3000K	88 - 145	88 - 133	71-5454-60-00 Adaptador / Adapter / Adaptateur / Adapter / Adattatore / Adaptador / Адаптер / Przystawka GU10 LED
						PC

					
71-3283-00-00  	71-3284-00-00  	71-5208-00-00  	71-5166-60-00 Panel de abeja / Honeycomb / Panneau en nid d'abeille / Wabentafel / Pannelo a nido d'ape / Favo de abelha / Панель в виде сот / Plaster pszczeli	71-5167-00-00 Difusor eliptico / Elliptical Diffuser / Diffuseur elliptique / Elliptischer Diffusor / Diffusore ellittico / Difusor eliptico / Эллиптический рассеиватель / Dyfuzor eliptyczny	71-4754-60-00 Confort visual/ Visual comfort/ Confort visuel/ Sichtkomfort/ Conforto visivo/ Conforto visual/ Визуальный комфорт/ Komfort wizualny
				PC	 

PC		PC	
			
			
	71-5123-14-00 71-5123-23-00 71-5123-60-00		71-5124-14-00 71-5124-23-00 71-5124-60-00

		AL	IP 54			ST	IP 54
							
				71-5128-14-00 Trimless			
71-5125-14-00 71-5125-23-00 71-5125-60-00							

PLAY DECO SQUARE

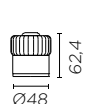

7W

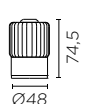

13W

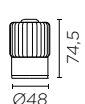

CRI93

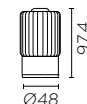

WARM DIMMING

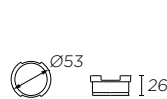

GU10 LED ADAPTER



LED CREE CRI80

A**... A	71-4030-14-37	<input type="checkbox"/>	2700K	570lm	7W	-	-	
	71-2909-14-37V1	<input type="checkbox"/>	3000K	620lm				
	71-5158-14-37	<input type="checkbox"/> NEW	4000K	660lm				
	71-3878-14-37	<input type="checkbox"/>	2700K	max. 570lm	max.7W		max. 700 mA	
	71-3225-14-37	<input type="checkbox"/>	3000K	max. 620lm				
	71-5130-14-37	<input type="checkbox"/> NEW	4000K	max. 660lm				



LED CREE CRI80

A**... A	71-4031-14-37	<input type="checkbox"/>	2700K	1240lm	13W	-	-	
	71-3226-14-37V1	<input type="checkbox"/>	3000K	1330lm				
	71-5159-14-37	<input type="checkbox"/> NEW	4000K					
	71-3881-14-37	<input type="checkbox"/>	2700K	max. 1240lm	max.13W		max. 350 mA	
	71-3882-14-37	<input type="checkbox"/>	3000K	max.1330lm				
	71-5131-14-37	<input type="checkbox"/> NEW	4000K					

CRI93

A**... A	71-5256-14-37	<input type="checkbox"/> NEW	2700K	940lm	13W	-	-	
	71-5165-14-37	<input type="checkbox"/> NEW			max.13W		max. 350 mA	



WARM DIMMING LED SHARP CRI90

A**... A	71-5236-14-37	<input type="checkbox"/> NEW	2000K - 3000K	930lm	13W		-	
----------	---------------	------------------------------	---------------	-------	-----	--	---	--

WARM DIMMING 2000 - 3000K

La tecnología LED WARM DIMMING proporciona una curva de regulación equivalente a la de una fuente incandescente. LED WARM-DIMMING technology offers a regulation curve equivalent to the one in an incandescent source.

La technologie LED WARM-DIMMING offre une courbe de réglage équivalente à celle d'une source à incandescence.

Die LED-Technologie „Warm Dimming“ bietet eine Regulierungskurve die zu der von Glühlampen äquivalent ist.

La tecnologia LED WARM DIMMING offre una curva di regolazione equivalente a quella di una fonte incandescente.

A tecnologia LED WARM-DIMMING proporciona uma curva de regulação equivalente à de uma fonte incandescente.

Светодиодная технология WARM-DIMMING (DT) позволяет регулировать яркость свечения, имитируя свет лампы накаливания.

Technologia LED WARM-DIMMING dostarcza krzywej regulacyjnej odpowiadającej tej źródła żarowego.

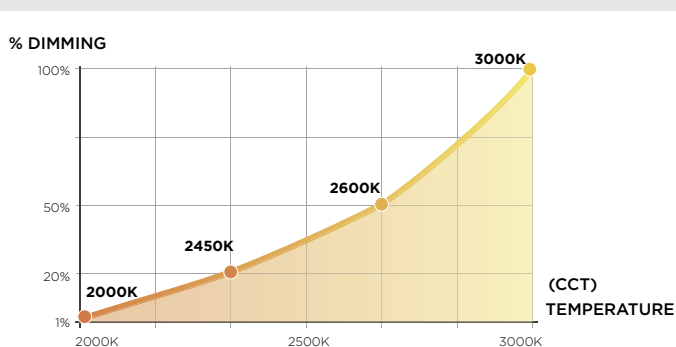



PLAY DECO SURFACE

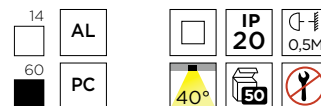

LED CREE

A**... A	Model	Color	Temp	Beam	Output	Power	Features
A**... A	15-5264-14-00	<input type="checkbox"/>	2700K	-	570lm	7W	E, 100-240V, 50-60Hz
	15-5264-60-00	<input checked="" type="checkbox"/>			620lm		
A**... A	15-5265-14-00	<input type="checkbox"/>	3000K	-	570lm	7W	E, 220-240V, 50-60Hz
	15-5265-60-00	<input checked="" type="checkbox"/>			620lm		
A**... A	15-5266-14-00	<input type="checkbox"/>	2700K	PHASE CUT	570lm	7W	E, 220-240V, 50-60Hz
	15-5266-60-00	<input checked="" type="checkbox"/>			620lm		
A**... A	15-5267-14-00	<input type="checkbox"/>	3000K	PHASE CUT	570lm	7W	E, 220-240V, 50-60Hz
	15-5267-60-00	<input checked="" type="checkbox"/>			620lm		

LED CREE

A**... A	Model	Color	Temp	Beam	Output	Power	Features
A**... A	15-5268-14-00	<input type="checkbox"/>	2700K	-	1240lm	13W	E, 100-240V, 50-60Hz
	15-5268-60-00	<input checked="" type="checkbox"/>			1330lm		
A**... A	15-5269-14-00	<input type="checkbox"/>	3000K	-	1240lm	13W	E, 220-240V, 50-60Hz
	15-5269-60-00	<input checked="" type="checkbox"/>			1330lm		
A**... A	15-5270-14-00	<input type="checkbox"/>	2700K	PHASE CUT	1240lm	13W	E, 220-240V, 50-60Hz
	15-5270-60-00	<input checked="" type="checkbox"/>			1330lm		
A**... A	15-5271-14-00	<input type="checkbox"/>	3000K	PHASE CUT	1240lm	13W	E, 220-240V, 50-60Hz
	15-5271-60-00	<input checked="" type="checkbox"/>			1330lm		

PC



71-4752-14-00V1 71-4752-23-00V1 71-4752-60-00V1



71-3283-00-00

71-3284-00-00

71-5208-00-00





PLAY

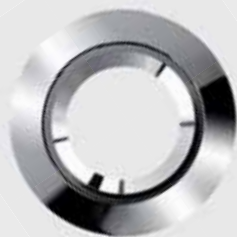
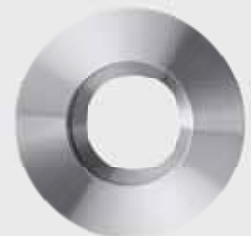
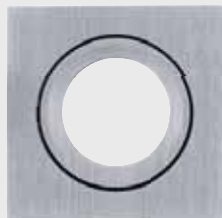
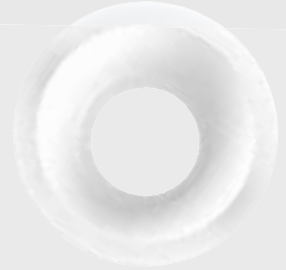
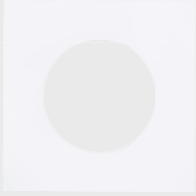











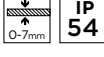

PLAY

					
7W 40° CRI 80 max.660lm 2700/3000/4000K *EMERGENCY	13W 40° CRI 80 max.1330lm 2700/3000/4000K *EMERGENCY	CRI93 13W 40° CRI 93 940lm 2700K	WARM DIMMING 13W 40° CRI 90 930lm 2000-3000K		71-5454-60-00 Adaptador / Adapter / Adaptateur / Adapter / Adattatore / Adaptador / Адаптер / Przystawka GU10 LED
					PC

***EMERGENCY:** see page 112

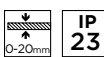
					
71-3283-00-00  	71-3284-00-00  	71-5208-00-00  	71-5166-60-00 Panel de abeja / Honeycomb / Panneau en nid d'abeille / Wabentafel / Pannelo a nido d'ape / Favo de abelha / Панель в виде сот / Plaster pszczeli	71-5167-00-00 Difusor elíptico / Elliptical Diffuser / Diffuseur elliptique / Elliptischer Diffusor / Diffusore ellittico / Difusor elíptico / Эллиптический рассеиватель / Dyfuzor eliptyczny	71-4754-60-00 Confort visual/ Visual comfort/ Confort visuel/ Sichtkomfort/ Confort visivo/ Conforto visual/ Визуальный комфорт/ Komfort wizualny
					PC 

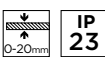
AL			
			
 	 	 	
71-2910-14-00 71-2910-AF-00  	71-2911-14-00 71-2911-AF-00  	71-2912-14-00 71-2912-AF-00  	71-2913-14-00  
			
 	  	  	  
71-2914-14-00 71-2914-AF-00  	71-2915-14-00 71-2915-AF-00 71-2915-21-00  	71-5138-14-00 71-5138-AF-00 71-5138-21-00  	71-5137-14-00 71-5137-AF-00 71-5137-21-00  

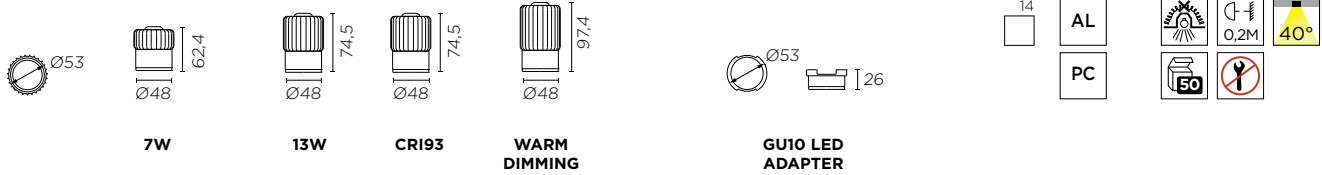

LED CREE **CRI80**

A**... A	71-4030-14-37	<input type="checkbox"/>	2700K	570lm	7W	-	-	
	71-2909-14-37V1	<input type="checkbox"/>	3000K	620lm				
	71-5158-14-37	<input type="checkbox"/> NEW	4000K	660lm				
	71-3878-14-37	<input type="checkbox"/>	2700K	max. 570lm	max.7W			
	71-3225-14-37	<input type="checkbox"/>	3000K	max. 620lm				
	71-5130-14-37	<input type="checkbox"/> NEW	4000K	max. 660lm				



LED CREE **CRI80**

A**... A	71-4031-14-37	<input type="checkbox"/>	2700K	1240lm	13W	-	-	
	71-3226-14-37V1	<input type="checkbox"/>	3000K	1330lm				
	71-5159-14-37	<input type="checkbox"/> NEW	4000K					
	71-3881-14-37	<input type="checkbox"/>	2700K	max. 1240lm	max.13W			
	71-3882-14-37	<input type="checkbox"/>	3000K	max.1330lm				
	71-5131-14-37	<input type="checkbox"/> NEW	4000K					

CRI93

71-5256-14-37	<input type="checkbox"/> NEW	2700K	940lm	13W	-	-	
	71-5165-14-37			<input type="checkbox"/> NEW	max.13W		



WARM DIMMING LED SHARP **CRI90**

A**... A	71-5236-14-37	<input type="checkbox"/> NEW	2000K - 3000K	930lm	13W		-	
----------	---------------	-------------------------------------	---------------	-------	-----	--	---	--

WARM DIMMING 2000 - 3000K

La tecnología LED WARM DIMMING proporciona una curva de regulación equivalente a la de una fuente incandescente. LED WARM-DIMMING technology offers a regulation curve equivalent to the one in an incandescent source.

La technologie LED WARM-DIMMING offre une courbe de réglage équivalente à celle d'une source à incandescence.

Die LED-Technologie „Warm Dimming“ bietet eine Regulierungskurve die zu der von Glühlampen äquivalent ist.

La tecnologia LED WARM DIMMING offre una curva di regolazione equivalente a quella di una fonte incandescente.

A tecnologia LED WARM-DIMMING proporciona uma curva de regulação equivalente à de uma fonte incandescente.

Светодиодная технология WARM-DIMMING (DT) позволяет регулировать яркость свечения, имитируя свет лампы накаливания.

Technologia LED WARM-DIMMING dostarcza krzywej regulacyjnej odpowiadającej tej źródła żarowego.

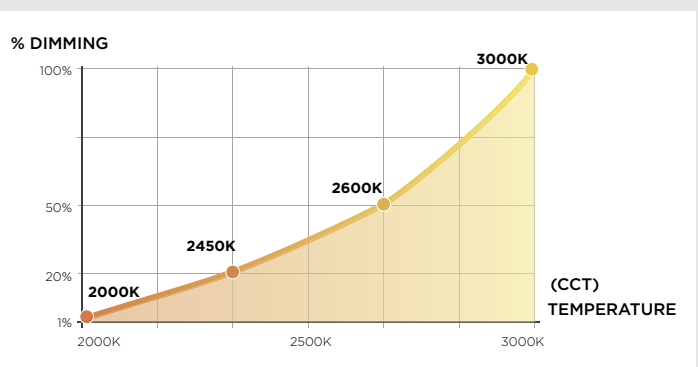



PLAY EMERGENCY



7W



13W



AL

PC



LED CREE **CRI80**

A+... A	71-4030-14-OE	<input type="checkbox"/> NEW	2700K	570lm	7W	-	-	* Emergency 3h 220-240V 50-60Hz
	71-2909-14-OE	<input type="checkbox"/> NEW	3000K	620lm				
	71-5158-14-OE	<input type="checkbox"/> NEW	4000K	660lm				



LED CREE **CRI80**

A+... A	71-4031-14-OE	<input type="checkbox"/> NEW	2700K	1240lm	13W	-	-	* Emergency 3h 220-240V 50-60Hz
	71-3226-14-OE	<input type="checkbox"/> NEW	3000K	1330lm				
	71-5159-14-OE	<input type="checkbox"/> NEW	4000K					



MINI PLAY

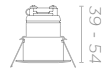

3,2W
24°
CRI 80
max.390lm
2700/3000/4000K



71-3818-00-00



AL



71-3819-14-00 71-3819-AF-00

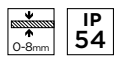

71-3820-14-00 71-3820-AF-00

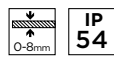

71-3821-14-00 71-3821-AF-00

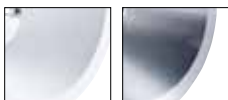
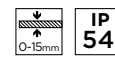

71-3822-14-00 71-3822-AF-00

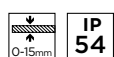
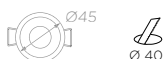

71-3823-14-00 71-3823-AF-00

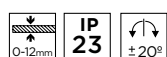

71-3824-14-00 71-3824-AF-00

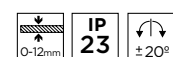

MINI PLAY

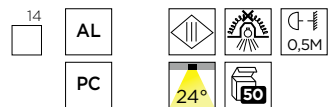
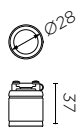

LED CREE

A**... A

71-3816-14-M2	<input type="checkbox"/>	2700K	max.290lm	max.3,2W		 P.682
71-3817-14-M2	<input type="checkbox"/>	3000K	max.310lm			
71-5477-14-M2	<input type="checkbox"/> NEW	4000K	max.390lm			



71-3818-00-00

LED 2700K 40° 3,2W

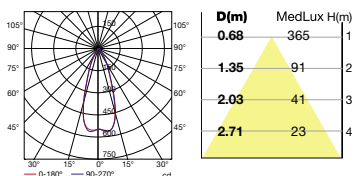

LED 3000K 40° 3,2W

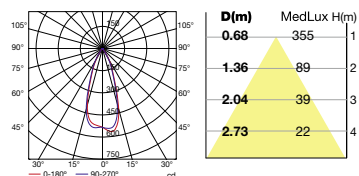

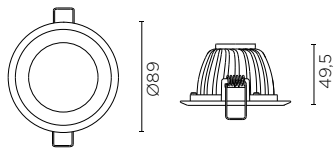

AL
PC

IP 54
0,2M
42°
10

LED BRIDGELUX

A**... A	90-1782-14-37		3000K	460lm	5,5W		100-240V 50-60Hz
----------	---------------	--	-------	-------	------	--	---------------------

LED 3000K 5,5W 42°

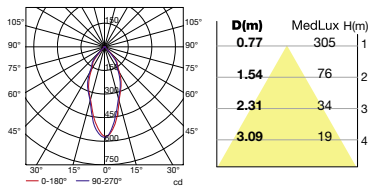

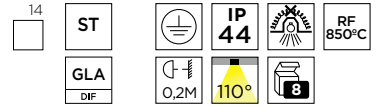
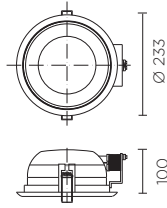

TC-D

G24d-2
A**... C

DN-1400-14-00	<input type="checkbox"/>	18W	 220-240V 50Hz	Standard
DN-1401-14-00	<input type="checkbox"/>	2x18W		

TC-D G24d-2 2x18W opal

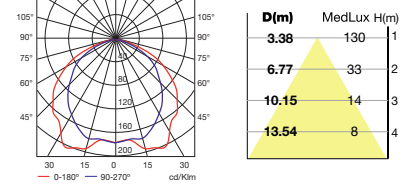

$\eta=55\%$

TC-D

G24d-3
A**... C

DN-1402-14-00	<input type="checkbox"/>	26W	 220-240V 50Hz	Standard
DN-1403-14-00	<input type="checkbox"/>	2x26W		

TC-D G24d-3 2x26W

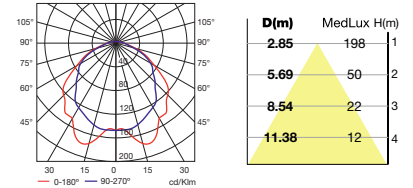

$\eta=47\%$

TC-DEL

G24q-2
A**... C

DN-1405-14-00	<input type="checkbox"/>	18W	 220-240V 50-60Hz	Standard
DN-1406-14-00	<input type="checkbox"/>	2x18W		
DN-1409-14-00	<input type="checkbox"/>			Emergency 3/1h

TC-DEL G24q-2 2x18W opal

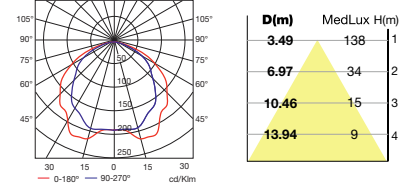

$\eta=61\%$

TC-DEL

G24q-3
A**... C

DN-1407-14-00	<input type="checkbox"/>	1x26W	 220-240V 50-60Hz	Standard
DN-1408-14-00	<input type="checkbox"/>	2x26W		
DN-1410-14-00	<input type="checkbox"/>			Emergency 3/1h

TC-DEL G24q-3 2x26W

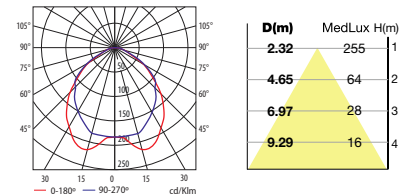

$\eta=53\%$



EQUAL SPOT

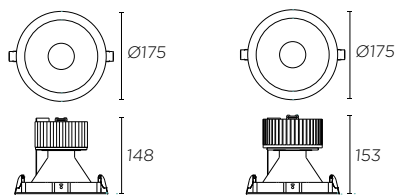

25,9W / 40,2W

44,8W



14



AL

N3

 PC
DIF

 IP
54

0,5M



40°

 RF
850°C

 M = 71-4894
N = 71-5328
Q = 71-4891

LED CREE

Zhaga Standard

A**... A

CRI 80

90-4748	14 - 37 N3	3000K	max. 2670lm	max. 25,9W		 P.682	
90-4749							4000K
90-2979			3000K	max. 3770lm	max. 40,2W		 P.682
90-2980							
90-3981			3000K	max. 4600lm	max. 44,8W		 P.682
90-3982			4000K				

CRI 90

90-3521	14 - 37 N3	3000K	max. 2020lm	max. 25,9W		 P.682				
90-3522							max. 3060lm	max. 40,2W		 P.682
90-3983							max. 3490lm	max. 44,8W		 P.682

LED CRI80 3000K 44,8W 40°

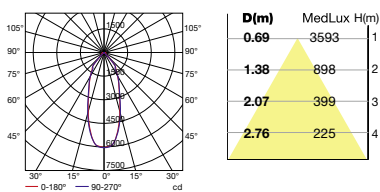

EQUAL S



Ø 160



160 x 160

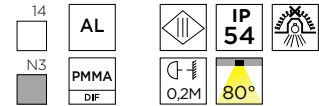

OE = 220-240V | EMERGENCY 3H | 50-60Hz



LED CREE

Zhaga Standard

A**... A



Code	Trim	Beam	Temp	lm	W	Dimming	Driver	Diagram
90-2022	14	M3	3000K	max. 2670lm	max. 25,9W	DIMMING max. 700 mA	M P.682	
90-2023			4000K					
90-2024			3000K	max. 3770lm	max. 40,2W	DIMMING max. 1050 mA	N P.682	
90-2025			4000K					
90-3984			3000K	max. 4600lm	max. 44,8W	DIMMING max. 1200 mA	Q P.682	
90-3985			4000K					
90-2022	N3	OE	3000K	2670lm	25,9W	-	E	
90-2023			4000K					
90-2024			3000K	3770lm	40,2W	-	E	
90-2025			4000K					
90-3984			3000K	4600lm	44,8W	-	E	
90-3985			4000K					

LED 3000K 44,8W 80°

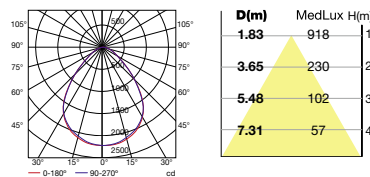

LED CREE

Zhaga Standard

A**... A



Code	Trim	Beam	Temp	lm	W	Dimming	Driver	Diagram
90-2026	14	M3	3000K	max. 2670lm	max. 25,9W	DIMMING max. 700 mA	M P.682	
90-2027			4000K					
90-2028			3000K	max. 3090lm	max. 29,6W	DIMMING max. 800 mA	O P.682	
90-2029			4000K					
90-2026	N3	OE	3000K	2670lm	25,9W	-	E	
90-2027			4000K					
90-2028			3000K	3090lm	29,6W	-	E	
90-2029			4000K					

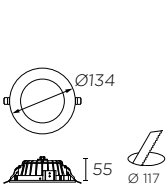

9,6W

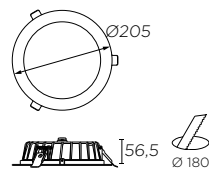

17,5W

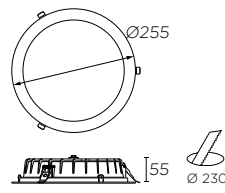

28W

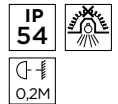
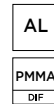

LED SAMSUNG

A**... A	90-4880-14-M3	<input type="checkbox"/>	3000K	820lm	9,6W	-	
	90-4881-14-M3	<input type="checkbox"/>	4000K				
	90-4880-14-OE	<input type="checkbox"/> NEW	3000K				
	90-4881-14-OE	<input type="checkbox"/> NEW	4000K				
	90-3925-14-M3	<input type="checkbox"/>	3000K	max. 820lm	max. 9,6W		
	90-3926-14-M3	<input type="checkbox"/>	4000K				



LED SAMSUNG

A**... A	90-2899-14-M3V1	<input type="checkbox"/>	3000K	1490lm	17,5W	-	
	90-4883-14-M3	<input type="checkbox"/>	4000K				
	90-2899-14-OE	<input type="checkbox"/> NEW	3000K				
	90-4883-14-OE	<input type="checkbox"/> NEW	4000K				
	90-3927-14-M3	<input type="checkbox"/>	3000K	max. 1490lm	max. 17,5W		
	90-3928-14-M3	<input type="checkbox"/>	4000K				



LED SAMSUNG

A**... A	90-4885-14-M3	<input type="checkbox"/>	3000K	2390lm	28W	-	
	90-4886-14-M3	<input type="checkbox"/>	4000K				
	90-4885-14-OE	<input type="checkbox"/> NEW	3000K				
	90-4886-14-OE	<input type="checkbox"/> NEW	4000K				
	90-3929-14-M3	<input type="checkbox"/>	3000K	max. 2390lm	max. 28W		
	90-3930-14-M3	<input type="checkbox"/>	4000K				



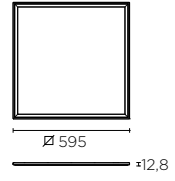

14 AL ANOD
54 PMMA DIF
N3

IP 40
180 Led
4

120°

LED

A++... A	15-5206-14-M1	<input type="checkbox"/>	3000K	3500lm	max. 42W	max. 1100 mA	G DIMMING P682
	15-5207-14-M1	<input type="checkbox"/>	4000K	3900lm			
	15-5428-14-M1	<input type="checkbox"/>	3000K	3500lm	42W	-	E 180-240V 50-60Hz
	15-5432-14-M1	<input type="checkbox"/>	4000K	3900lm			
	15-5431-14-M1	<input type="checkbox"/>	3000K	3500lm			
	15-5433-14-M1	<input type="checkbox"/>	4000K	3900lm			
						E 100-240V 50-60Hz	

LED 3000K 40W

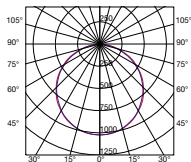

D(m)	MedLux	H(m)
3.14	237	1
6.26	59	2
9.40	26	3
12.53	15	4

LED 4000K 40W

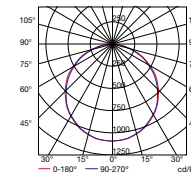

D(m)	MedLux	H(m)
3.14	256	1
6.28	64	2
9.42	28	3
12.56	16	4

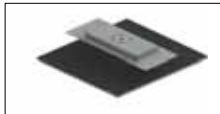

71-4722-N3-00	<input type="checkbox"/>	60X60	Kit de superfície plafón / Surface kit ceiling light / Kit surface Plafonnier/ Kit für Aufbau- montage / Kit per montaggio a plafoniera / Kit para instalação em superfície / Набор аксессуаров для поверхностного монтажа / Zestaw dla instalacji na powierzchni
---------------	--------------------------	-------	---



71-0558-54-00	<input type="checkbox"/>	60X60 630 x 630	Kit empotrar plafón / Recessed kit ceiling light / Kit d'encastrement plafonnier / Kit für Einbaumontage / Kit per incasso / Kit para instalação encastrada / Набор аксессуаров для встроенного монтажа / Zestaw dla instalacji wbudowanej No necesario en techos tipo Armstrong / Not required in Armstrong ceiling units
---------------	--------------------------	--------------------	---

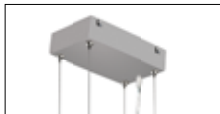

71-4723-N3-00	<input type="checkbox"/>	60X60	Kit suspensión plafón / Suspension kit ceiling light / Kit de suspension plafonnier / Aufhängungskit / Kit per sospensione / Kit para instalação suspensa / Набор аксессуаров для подвешного монтажа / Zestaw dla instalacji zawieszonej
---------------	--------------------------	-------	--

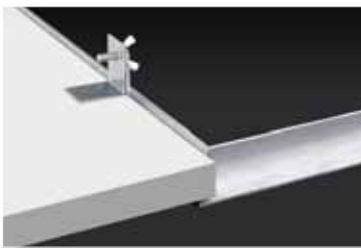
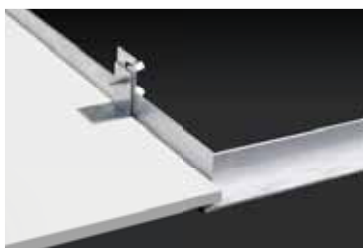
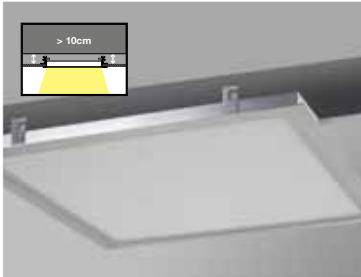
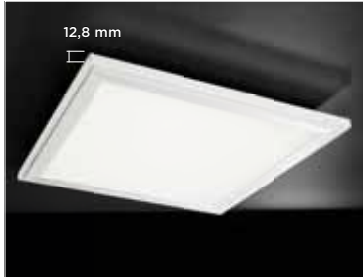



BACKLIGHT

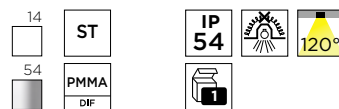
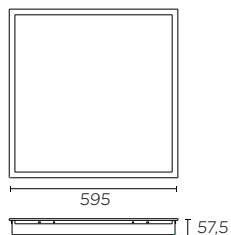

LED REFOND

A+... A	15-5058-14-M1	<input type="checkbox"/>	3000K	3200lm	35W	-	
	15-5059-14-M1	<input type="checkbox"/>	4000K				
	15-4860-14-M1	<input type="checkbox"/>	3000K	max. 3200lm	max. 35W		
	15-4861-14-M1	<input type="checkbox"/>	4000K				

Accesorios / Accessories / Accessoires / Zubehöre / Accessori / Acessórios / Аксессуары / Akcesoria



71-0558-54-00	<input type="checkbox"/>	 630 x 630	Kit empotrar plafón / Recessed kit ceiling light / Kit d'encastrement plafonnier / Kit für Einbaumontage / Kit per incasso / Kit para instalação encastrada / Набор аксессуаров для встроенного монтажа / Zestaw dla instalacji wbudowanej No necesario en techos tipo Armstrong / Not required in Armstrong ceiling units
---------------	--------------------------	---------------	---



DELTA COB

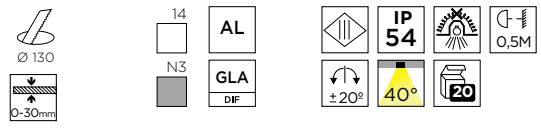
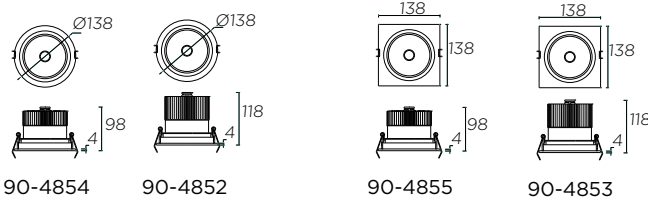

DRIVER
M = 71-4894
S = 71-4890

LED CREE

A**... A	Part Number	Color	Temp	max. lm	max. W	Dimming	max. mA	Driver
A**... A	90-4854-14-37	□	3000K	max. 2670lm	max. 25,9W	DIMMING	max. 700 mA	P.682 P.682
	90-4854-N3-37	■						
	90-4852-14-37	□						
	90-4852-N3-37	■						



LED 3000K 25,9W 40°

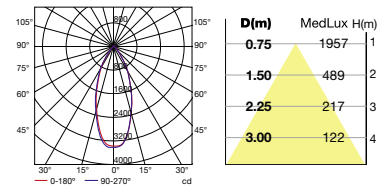

LED CREE

A**... A	Part Number	Color	Temp	max. lm	max. W	Dimming	max. mA	Driver
A**... A	90-4855-14-37	□	3000K	max. 2670lm	max. 25,9W	DIMMING	max. 700 mA	P.682 P.682
	90-4855-N3-37	■						
	90-4853-14-37	□						
	90-4853-N3-37	■						

LED 3000K 38W 40°

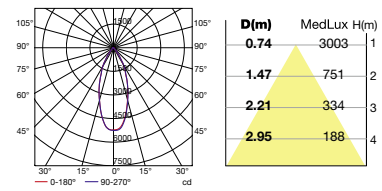

Accesorios / Accessories / Accessoires / Zubehöre / Accessori / Acessórios / Аксессуары / Akcesoria



71-2918-00-00



LED 3000K 25,9W 20°

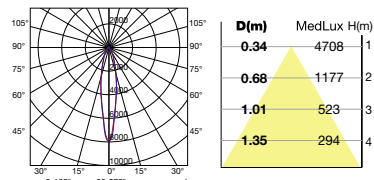

LED 3000K 38W 20°

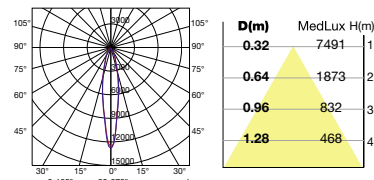



CARDEX C

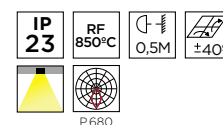
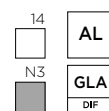
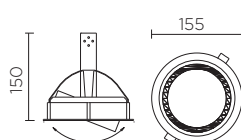

QR-111 / AR-111 LED

G53 (max. H=77 mm)



DN-0270-14-00	<input type="checkbox"/>
DN-0270-N3-00	<input type="checkbox"/>

max.100W



12V

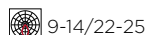

A*... C

HIT-T

G12



HIT-T
150W



A*... A

DN-0274-14-00	<input type="checkbox"/>	10°	max.150W		-
DN-0274-N3-00	<input type="checkbox"/>				
DN-1653-14-00	<input type="checkbox"/>	24°			
DN-1653-N3-00	<input type="checkbox"/>				
DN-0273-14-00	<input type="checkbox"/>	45°			
DN-0273-N3-00	<input type="checkbox"/>				

HIT-T G12 70W 24°

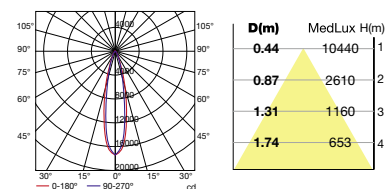

$\eta=64\%$

AR-111 LED

GU10 (max. H=100 mm)



DN-1652-14-00	<input type="checkbox"/>
DN-1652-N3-00	<input type="checkbox"/>

max.15W

-

-



A*... A

Accesorios / Accessories / Accessoires / Zubehöre / Accessori / Acessórios / Аксессуары / Akcesoria



ACT-9180-60-00 HIT-T

CARDEX C

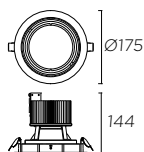

RECOMMENDED DRIVER
M = 71-4894
N = 71-4890
C = 71-4892

LED CREE
Zhaga Standard
A**... A

CRI80

Model	Beam Angle	Temp	Temp	Temp	Temp	Temp	Temp	Temp	
90-4735	14 - 37	N3	12°	max. 2690lm	max. 25,9W	DIMMING max. 700 mA	P.682	M	
90-4736			24°						3000K
90-4737			38°						4000K
90-4738			12°						3000K
90-4739			24°						4000K
90-4740	38°	4000K							
90-3501	14 - 37	N3	12°	max. 3770lm	max. 40,2W	DIMMING max. 1050 mA	P.682	N	
90-3502			24°						3000K
90-3503			38°						4000K
90-3504			12°						3000K
90-3505			24°						4000K
90-3506	38°	4000K							
90-4041	14 - 37	N3	12°	max. 5120lm	max. 53,2W	DIMMING max. 1400 mA	P.682	C	
90-4042			24°						3000K
90-4043			38°						4000K
90-4044			12°						3000K
90-4045			24°						4000K
90-4046	38°	4000K							

LED 3000K 53,2W 12°

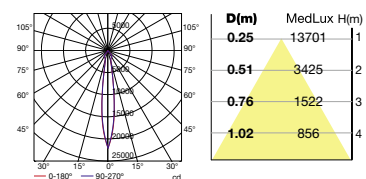

LED 3000K 53,2W 24°

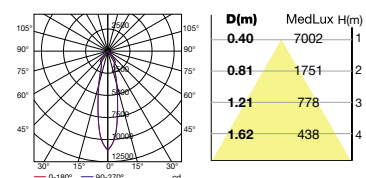

LED 3000K 53,2W 38°

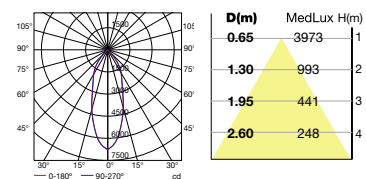

Accesorios / Accessories / Accessoires / Zubehöre / Accessori / Acessórios / Аксессуары / Akcesoria



ACT-9180-60-00

CARDEX C

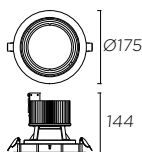

M = 71-4894
N = 71-4890
C = 71-4892

LED CREE
Zhaga Standard
A+... A

CRI 90

90-3297	14	12°	3000K	max. 2020lm	max. 25,9W	 max. 700 mA	 P682
90-3298	- 37	24°					
90-3299	N3	38°					
90-3507	14	12°		max. 3060lm	max. 40,2W	 max. 1050 mA	 P682
90-3508	- 37	24°					
90-3509	N3	38°					
90-4047	14	12°		max. 3880lm	max. 53,2W	 max. 1400 mA	 P682
90-4048	- 37	24°					
90-4049	N3	38°					

Accesorios / Accessories / Accessoires / Zubehöre / Accessori / Acessórios / Аксессуары / Akcesoria



ACT-9180-60-00

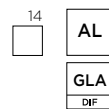
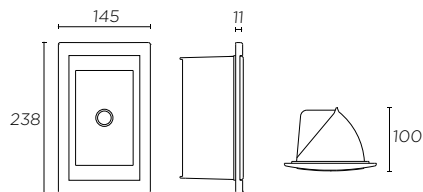

OUT SQUARE

NEW

 N = 71-5328
 Q = 71-4891

LED CREE
 Zhaga Standard
A+... A
CRI 80

90-5139-14-37	<input type="checkbox"/>	-	3000K	3460lm	max. 38,6W	max. 1000 mA	 P.682
90-5143-14-37	<input type="checkbox"/>		4000K				
90-5144-14-37	<input type="checkbox"/>	-	3000K	4600lm	max. 44,8W	max. 1200 mA	 P.682
90-5147-14-37	<input type="checkbox"/>		4000K				

CRI 90

90-5149-14-37	<input type="checkbox"/>	-	3000K	3490lm	max. 44,8W	max. 1200 mA	 P.682
---------------	--------------------------	---	-------	--------	---------------	---------------------------	-----------

OUT



OUT S

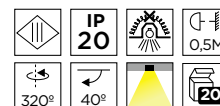

M = 71-4894

LED CREE

Zhaga Standard

A**... A

CRI 80

90-4781-14-37	<input type="checkbox"/>	15°	3000K	max. 2670lm	max. 25,9W	max. 700 mA	P.682
90-4782-14-37	<input type="checkbox"/>	30°					
90-4783-14-37	<input type="checkbox"/>	50°					
90-4788-14-37	<input type="checkbox"/>	15°					
90-4789-14-37	<input type="checkbox"/>	30°	4000K				
90-4790-14-37	<input type="checkbox"/>	50°					

LED CRI80 3000K

25,9W 30°

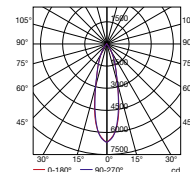

CRI 90

90-4791-14-37	<input type="checkbox"/>	15°	3000K	max. 2020lm	max. 25,9W	max. 700 mA	P.682
90-4792-14-37	<input type="checkbox"/>	30°					
90-4793-14-37	<input type="checkbox"/>	50°					

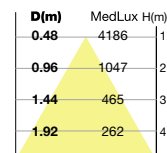

OUT L

 N = 71-4890
Q = 71-4891

LED CREE

Zhaga Standard

A**... A

CRI 80

90-4766-14-37	<input type="checkbox"/>	15°	3000K	max. 3580lm	max. 40,9W	max. 1050 mA	P.682
90-4767-14-37	<input type="checkbox"/>	30°					
90-4768-14-37	<input type="checkbox"/>	50°					
90-4769-14-37	<input type="checkbox"/>	15°	4000K				
90-4770-14-37	<input type="checkbox"/>	30°					
90-4771-14-37	<input type="checkbox"/>	50°	3000K	max. 4600lm	max. 44,8W	max. 1200 mA	P.682
90-4775-14-37	<input type="checkbox"/>	15°					
90-4776-14-37	<input type="checkbox"/>	30°					
90-4777-14-37	<input type="checkbox"/>	50°	4000K				
90-4778-14-37	<input type="checkbox"/>	15°					
90-4779-14-37	<input type="checkbox"/>	30°	4000K				
90-4780-14-37	<input type="checkbox"/>	50°					

LED CRI80 3000K

44,8W 30°

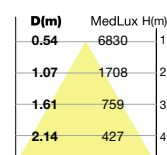
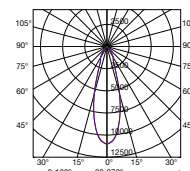

CRI 90

90-4772-14-37	<input type="checkbox"/>	15°	3000K	max. 3490lm	max. 44,8W	max. 1200 mA	P.682
90-4773-14-37	<input type="checkbox"/>	30°					
90-4774-14-37	<input type="checkbox"/>	50°					



ASICS STORE. MONTPELLIER, FRANCE
CREDIT PHOTO: DRAGON ROUGE - 2015



asics THE HISTORY

1977
HERITAGE OF THE ASICS

Le modèle classique de la gamme ASICS est né en 1977. C'est l'année où la marque a introduit le modèle ASICS HERITAGE, un modèle qui a marqué le début d'une ère nouvelle pour la marque. Ce modèle est devenu le modèle de référence pour tous les modèles ASICS qui ont suivi.

Serious Runners Don't Use On-Airs

Le modèle ASICS HERITAGE est devenu le modèle de référence pour tous les modèles ASICS qui ont suivi. C'est l'année où la marque a introduit le modèle ASICS HERITAGE, un modèle qui a marqué le début d'une ère nouvelle pour la marque.

1990
GEL-LYTE III

Le modèle ASICS GEL-LYTE III est devenu le modèle de référence pour tous les modèles ASICS qui ont suivi. C'est l'année où la marque a introduit le modèle ASICS GEL-LYTE III, un modèle qui a marqué le début d'une ère nouvelle pour la marque.

1991
GEL-SAGA

Le modèle ASICS GEL-SAGA est devenu le modèle de référence pour tous les modèles ASICS qui ont suivi. C'est l'année où la marque a introduit le modèle ASICS GEL-SAGA, un modèle qui a marqué le début d'une ère nouvelle pour la marque.

1993
GEL-LYTE V

Le modèle ASICS GEL-LYTE V est devenu le modèle de référence pour tous les modèles ASICS qui ont suivi. C'est l'année où la marque a introduit le modèle ASICS GEL-LYTE V, un modèle qui a marqué le début d'une ère nouvelle pour la marque.

1949
LANCEMENT D'ONITSUKA

Le modèle ASICS ONITSUKA est devenu le modèle de référence pour tous les modèles ASICS qui ont suivi. C'est l'année où la marque a introduit le modèle ASICS ONITSUKA, un modèle qui a marqué le début d'une ère nouvelle pour la marque.

1952
OK SHOE

Le modèle ASICS OK SHOE est devenu le modèle de référence pour tous les modèles ASICS qui ont suivi. C'est l'année où la marque a introduit le modèle ASICS OK SHOE, un modèle qui a marqué le début d'une ère nouvelle pour la marque.

1966
MEXICO

Le modèle ASICS MEXICO est devenu le modèle de référence pour tous les modèles ASICS qui ont suivi. C'est l'année où la marque a introduit le modèle ASICS MEXICO, un modèle qui a marqué le début d'une ère nouvelle pour la marque.



MULTIDIR EVO





MULTIDIR EVO L



LED

25,9W

CRI 80 / CRI 90
12° / 24° / 38°
2000lm / 2700lm
3000 / 4000K

40,2W

CRI 80 / CRI 90
12° / 24° / 38°
3100lm / 3800lm
3000 / 4000K



**HIT-TC
G8.5**

70W
10° / 24° / 45°



**QR-111 / AR-111 LED
G53**

max. 100W



**CDM-R111
GX8.5**

max. 70W



**AR-111 LED
GU10**

max. 15W



TRIM



71-2948-14-00 71-2948-N3-00 71-2948-60-00

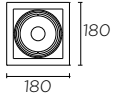

180

180



71-2949-14-00 71-2949-N3-00 71-2949-60-00

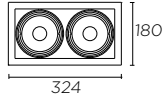

180

324



71-2950-14-00 71-2950-N3-00 71-2950-60-00

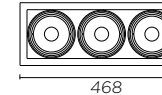

180

468

TRIMLESS



71-2951-14-00 71-2951-60-00

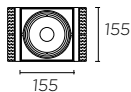

155

155



71-2952-14-00 71-2952-60-00

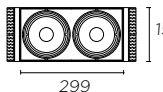

155

299



71-2953-14-00 71-2953-60-00

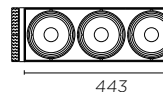

155

443

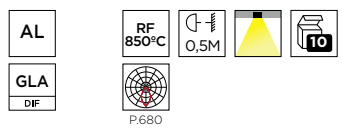

RECOMMENDED DRIVER
M = 71-4894
N = 71-5328



LED CREE Zhaga Standard



A**... A

CRI 80

71-4741-00-37	12°	3000K	max. 2670lm	max. 25,9W	DIMMING	max. 700 mA	M P.682
71-4742-00-37	24°						
71-4743-00-37	38°						
71-4744-00-37	12°						
71-4745-00-37	24°	4000K					
71-4746-00-37	38°						
71-2971-00-37	12°	3000K	max. 3770lm	max. 40,2W	DIMMING	max. 1050 mA	N P.682
71-2972-00-37	24°						
71-2973-00-37	38°						
71-2974-00-37	12°	4000K					
71-2975-00-37	24°						
71-2976-00-37	38°						

CRI 90

71-3515-00-37	12°	3000K	max. 2020lm	max. 25,9W	DIMMING	max. 700 mA	M P.682
71-3516-00-37	24°						
71-3517-00-37	38°						
71-3518-00-37	12°						
71-3519-00-37	24°	4000K	max. 3060lm	max. 40,2W	DIMMING	max. 1050 mA	N P.682
71-3520-00-37	38°						

Accesorios / Accessories / Accessoires / Zubehöre / Accessori / Acessórios / Аксессуары / Akcesoria

ACT-9180-60-00



HIT-TC

G8.5



A*... A

71-2963-00-37	10°	max. 70W	P.691	-
71-3224-00-37	24°			
71-2964-00-37	45°			

QR-111 / AR-111 LED

G53



A**... C

71-2956-00-00	max.100W	P.691	12V	9-14/22-25
---------------	----------	-------	-----	------------

CDM-R111

GX8.5



A*... A

71-2955-00-00	max.70W	P.691	-	15-20
---------------	---------	-------	---	-------

AR-111 LED

GU10



A**... A

71-2954-00-00	max.15W	-	-	22-25
---------------	---------	---	---	-------

MULTIDIR EVO S

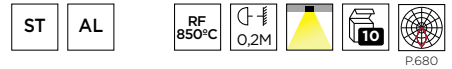
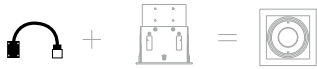

QR-CBC51 / MR16

GU5.3



QR-CBC51
>35W

71-3212-00-00

max. 50W



12V

1-8

A**... C

QPAR-16

GU10



A**... C

71-2954-00-00

max. 50W

22-25

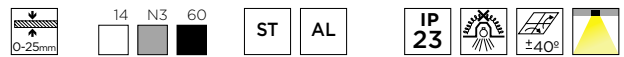
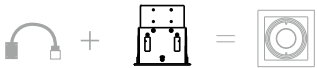

TRIM

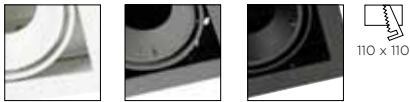

71-2942-14-00 71-2942-N3-00 71-2942-60-00

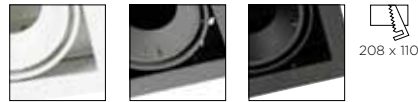

71-2943-14-00 71-2943-N3-00 71-2943-60-00

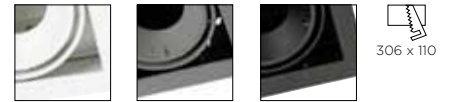

71-2944-14-00 71-2944-N3-00 71-2944-60-00

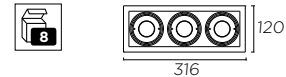

TRIMLESS

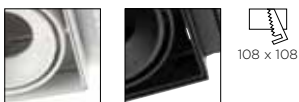

71-2945-14-00 71-2945-60-00



71-2946-14-00 71-2946-60-00

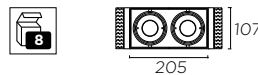

71-2947-14-00 71-2947-60-00

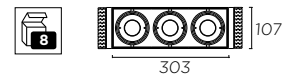

MULTIDIR EVO L			POSITION 1	POSITION 2	POSITION 3	POSITION 4
71-2954-00-00	GU10	ACT-FLL-015, 017, 032, 033	X	✓ H max. 80mm	✓ H max. 100mm	✓
71-2955-00-00	GX8,5	-	X	✓	✓	✓
71-2956-00-00	G53	ACT-FLL-011, 013, 030, 031	✓ H max. 77mm	✓ H max. 102mm	✓ H max. 122mm	✓
71-2963-00-37	G8.5	-	X	✓	✓	✓
71-3224-00-37						
71-2964-00-37						
71-4741-00-37	LED ZHAGA	-	X	X	✓	✓
71-4742-00-37						
71-4743-00-37						
71-4744-00-37						
71-4745-00-37						
71-4746-00-37						
71-2971-00-37						
71-2972-00-37						
71-2973-00-37						
71-2974-00-37						
71-2975-00-37						
71-2976-00-37						
71-3515-00-37						
71-3516-00-37						
71-3517-00-37						
71-3518-00-37						
71-3519-00-37						
71-3520-00-37						

MULTIDIR EVO S			POSITION 1	POSITION 2	POSITION 3	POSITION 4
71-3212-00-00	GU5.3	-	✓ H max. 50mm	✓ H max. 75mm	✓ H max. 95mm	✓
71-2954-00-00	GU10 / IN	-	X	✓ H max. 50mm	✓ H max. 75mm	✓

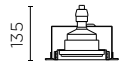
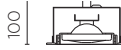
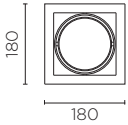
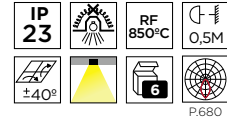
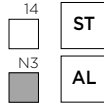

G53

GU10

QR-111 / AR-111 LED

G53	DM-0061-14-00	<input type="checkbox"/>	max. 100W			9-14/ 22-25
12V	DM-0061-N3-00	<input type="checkbox"/>				
	QR-111>65W					

A**... C

AR-111 LED

GU10	DM-1155-14-00	<input type="checkbox"/>	max. 15W	-		22-25
	DM-1155-N3-00	<input type="checkbox"/>				

A*... A

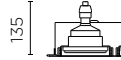
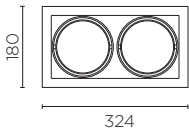

G53

GU10

QR-111 / AR-111 LED

G53	DM-0062-14-00	<input type="checkbox"/>	2 x max.100W			9-14/ 22-25
12V	DM-0062-N3-00	<input type="checkbox"/>				
	QR-111>65W					

A**... C

AR-111 LED

GU10	DM-1156-14-00	<input type="checkbox"/>	2 x max.15W	-		22-25
	DM-1156-N3-00	<input type="checkbox"/>				

A*... A

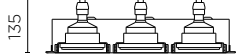
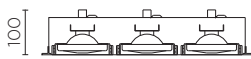
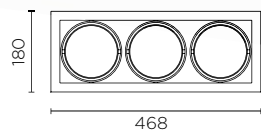

G53

GU10

QR-111 / AR-111 LED

G53	DM-0063-14-00	<input type="checkbox"/>	3 x max.100W			9-14/ 22-25
12V	DM-0063-N3-00	<input type="checkbox"/>				
	QR-111>65W					

A**... C

AR-111 LED

GU10	DM-1157-14-00	<input type="checkbox"/>	3 x max.15W	-		22-25
	DM-1157-N3-00	<input type="checkbox"/>				

A*... A

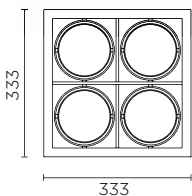

G53

GU10

QR-111 / AR-111 LED

G53	DM-0064-14-00	<input type="checkbox"/>	4 x max.100W			9-14/ 22-25
12V	DM-0064-N3-00	<input type="checkbox"/>				
	QR-111>65W					

A**... C

AR-111 LED

GU10	DM-1158-14-00	<input type="checkbox"/>	4 x max.15W	-		22-25
	DM-1158-N3-00	<input type="checkbox"/>				

A*... A



14

ST

N3

AL



IP 23



RF 850°C



0,5M

±40°



12V



P.680

QR-CBC51 / MR16

GU5.3 max. H=55mm

DM-0053-14-00

max. 50W



1-8



QR-CBC51 >35W

A**... C



110 x 110

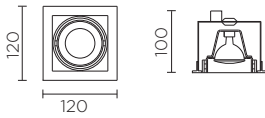

QR-CBC51 / MR16

GU5.3 max. H=55mm

DM-0054-14-00

2 x max.
50W



1-8



QR-CBC51 >35W

A**... C



208 x 110

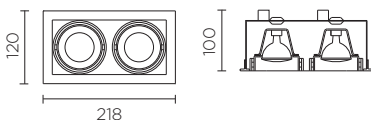

QR-CBC51 / MR16

GU5.3 max. H=55mm

DM-0055-14-00

3 x max.
50W



1-8



QR-CBC51 >35W

A**... C



306 x 110

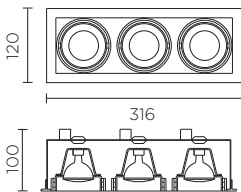

QR-CBC51 / MR16

GU5.3 max. H=55mm

DM-0056-14-00

4 x max.
50W



1-8



QR-CBC51 >35W

A**... C



215 x 215

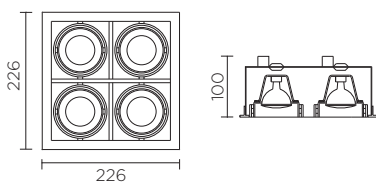

MULTIDIR TRIMLESS

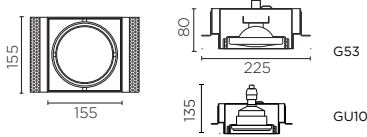
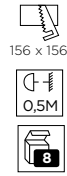
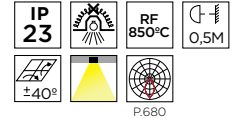
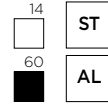

QR-111 / AR-111 LED

G53	DM-0081-14-00	<input type="checkbox"/>	max. 100W			9-14/ 22-25
	DM-0081-60-00	<input checked="" type="checkbox"/>				
	QR-111>65W					
A**... C						

AR-111 LED

GU10	DM-1159-14-00	<input type="checkbox"/>	max. 15W	-		22-25
	DM-1159-60-00	<input checked="" type="checkbox"/>				
A*... A						

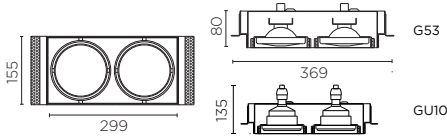
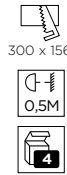

QR-111 / AR-111 LED

G53	DM-0082-14-00	<input type="checkbox"/>	2 x max.100W			9-14/ 22-25
	DM-0082-60-00	<input checked="" type="checkbox"/>				
	QR-111>65W					
A**... C						

AR-111 LED

GU10	DM-1160-14-00	<input type="checkbox"/>	2 x max.15W	-		22-25
	DM-1160-60-00	<input checked="" type="checkbox"/>				
A*... A						

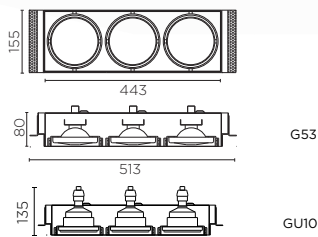

QR-111 / AR-111 LED

G53	DM-0083-14-00	<input type="checkbox"/>	3 x max.100W			9-14/ 22-25
	DM-0083-60-00	<input checked="" type="checkbox"/>				
	QR-111>65W					
A**... C						

AR-111 LED

GU10	DM-1161-14-00	<input type="checkbox"/>	3 x max.15W	-		22-25
	DM-1161-60-00	<input checked="" type="checkbox"/>				
A*... A						

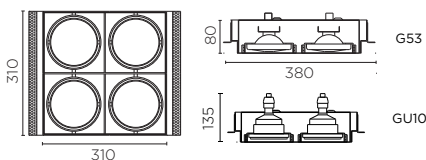
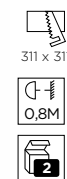

QR-111 / AR-111 LED

G53	DM-0084-14-00	<input type="checkbox"/>	4 x max.100W			9-14/ 22-25
	DM-0084-60-00	<input checked="" type="checkbox"/>				
	QR-111>65W					
A**... C						

AR-111 LED

GU10	DM-1162-14-00	<input type="checkbox"/>	4 x max.15W	-		22-25
	DM-1162-60-00	<input checked="" type="checkbox"/>				
A*... A						

MULTIDIR TRIMLESS

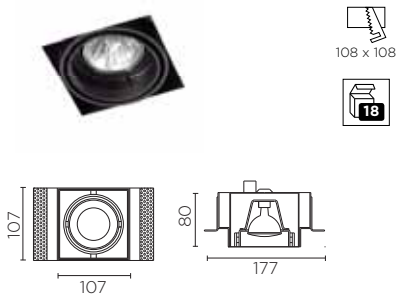
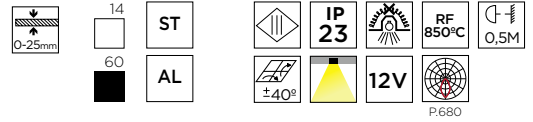
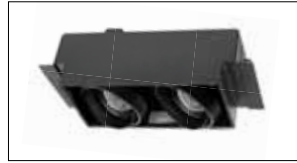

QR-CBC51 / MR16

GU5.3
(max. H=55mm)

DM-0093-14-00	<input type="checkbox"/>	max. 50W		
DM-0093-60-00	<input checked="" type="checkbox"/>			



QR-CBC51 >35W
A**... C

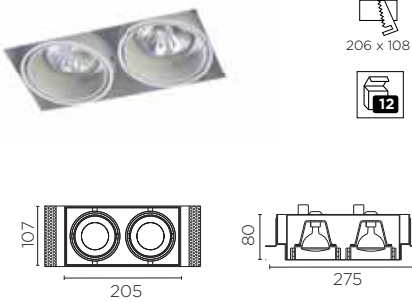

QR-CBC51 / MR16

GU5.3
(max. H=55mm)

DM-0094-14-00	<input type="checkbox"/>	2 x max. 50W		
DM-0094-60-00	<input checked="" type="checkbox"/>			



QR-CBC51 >35W
A**... C

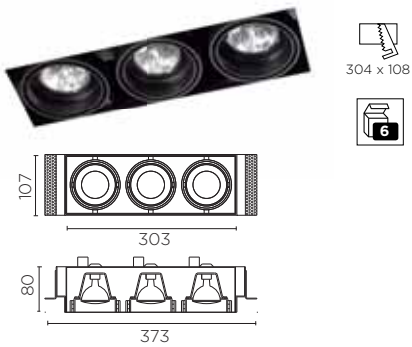

QR-CBC51 / MR16

GU5.3
(max. H=55mm)

DM-0095-14-00	<input type="checkbox"/>	3 x max. 50W		
DM-0095-60-00	<input checked="" type="checkbox"/>			



QR-CBC51 >35W
A**... C

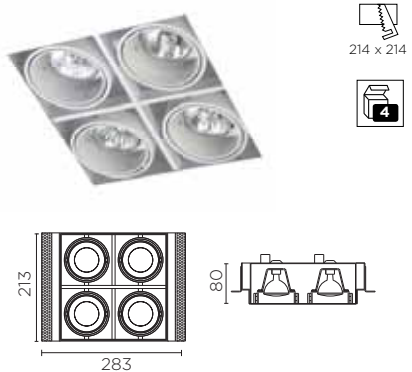

QR-CBC51 / MR16

GU5.3
(max. H=55mm)

DM-0096-14-00	<input type="checkbox"/>	4 x max. 50W		
DM-0096-60-00	<input checked="" type="checkbox"/>			



QR-CBC51 >35W
A**... C



EXIT

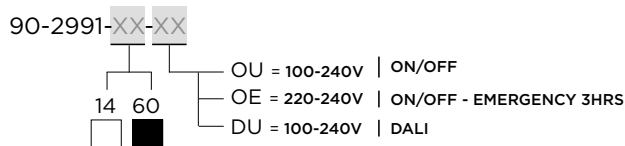
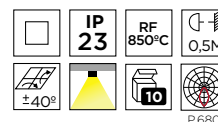
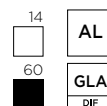
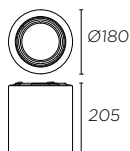

LED CREE Zhaga Standard A+... A

	CRI 80	XX	XX				
90-2991				12°	3000K	2670 lm	25,9W
90-2992	14	OU	24°				
90-2993	-	-	38°				
90-2994			DU	12°	4000K	2670 lm	25,9W
90-2995	60	OE	24°				
90-2996				38°			
90-2997				12°	3000K	3090 lm	29,6W
90-2998	14	OU	24°				
90-2999	-	-	38°				
90-3000			DU	12°	4000K	3090 lm	29,6W
90-3204	60	OE	24°				
90-3207				38°			

	CRI 90						
90-3523			OU	12°	3000K	2020 lm	25,9W
90-3524	14	DU	24°				
90-3525	-	-	OE	38°			
90-3526			OU	12°	4000K	2750 lm	33,7W
90-3527	60	OU	24°				
90-3528				38°			

LED 3000K 29,6W 24°

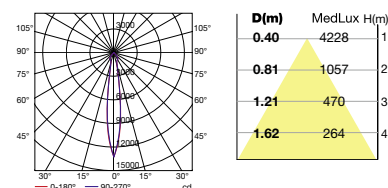

Accesorios / Accessories / Accessoires / Zubehöre / Accessori / Acessórios / Аксессуары / Акcesoria



ACT-9180-60-00

QR-111

G53 (max. H=77 mm)	90-2984-14-00	<input type="checkbox"/>	max.100W	220-240V 50-60Hz	
A+... C	90-2984-60-00	<input checked="" type="checkbox"/>			

AR-111 LED

GU10 (max. H=100 mm)	90-2981-14-00	<input type="checkbox"/>	max.15W	-	
A+... A	90-2981-60-00	<input checked="" type="checkbox"/>			



EXIT

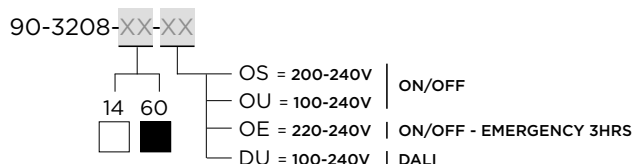
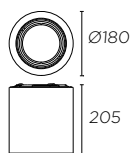

HIT-TC

		XX	XX			
G8.5	90-2985			10°	35W	220-240V 50-60Hz
A**... A	90-2986	14		24°		
	90-2987			45°		
	90-2988		OS	10°		
	90-2989	60		24°		
	90-2990			45°		
					50W	

HIT-TC G8.8 50W 45°

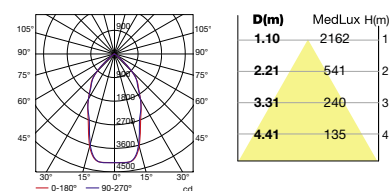

Accesorios / Accessories / Accessoires / Zubehöre / Accessori / Acessórios / Аксессуары / Akcesoria



ACT-9180-60-00

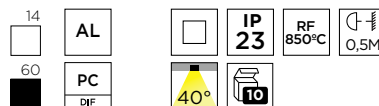
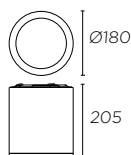

LED CREE

Zhaga Standard

A**... A

		CRI 80	XX	XX				
	90-3208	14	OU	40°	3000K	2670 lm	25,9W	
	90-3209	60	DU OE		4000K			
	90-3210	14	OU	40°	3000K	3090 lm	29,6W	
	90-3211	60	OU		4000K			
	90-3529	14	OU DU OE	40°	3000K	2020 lm	25,9W	
	90-3530	14	OU		3000K			

LED 3000K 29,6W 40°

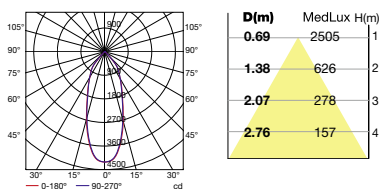

Accesorios / Accessories / Accessoires / Zubehöre / Accessori / Acessórios / Аксессуары / Akcesoria

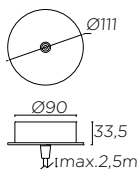

71-3223-14-00



Kit suspensión /
Suspension kit /
Kit suspension /
Aufhängekit / Kit
sospensione / Kit de
suspensão / Набор
для подвешного
монтажа/ Zestaw do
zawieszenia

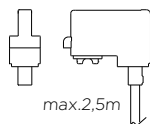

71-3531-60-00



Kit suspensión carril /
Track suspended kit /
Kit suspension /
Aufhängekit /
Kit sospensione /
Kit de suspensão /
Набор для
подвешного монтажа
для шины / Zestaw do
zawieszenia



BACO

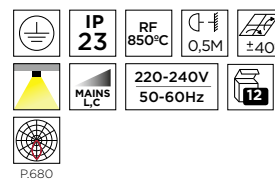
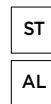
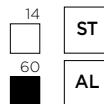
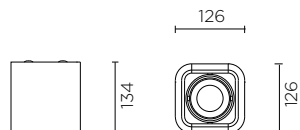

GU5.3

A**... C

DM-1150-14-00	<input type="checkbox"/>	max. 50W			1-8
DM-1150-60-00	<input checked="" type="checkbox"/>				

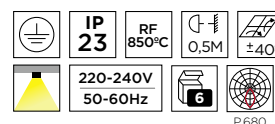
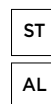
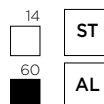
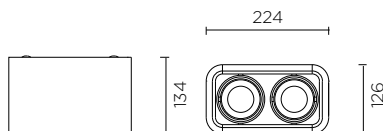

GU5.3

A**... C



DM-1151-14-00	<input type="checkbox"/>	2 x max. 50W			1-8
DM-1151-60-00	<input checked="" type="checkbox"/>				

GU5.3

(max. H=50 mm)

90-3550-14-00	<input type="checkbox"/>	2 x max. 7W	
90-3550-60-00	<input checked="" type="checkbox"/>		

Solo compatible con bombillas LEDS-C4 / Only compatible with LEDS-C4 bulbs / Uniquement compatible avec des ampoules LEDS-C4 / Nur mit LEDS-C4-Lampen kompatibel / Compatibile soltanto con lampadine LEDS-C4 / Compatível apenas com lâmpadas LEDS-C4 / Совместимы только с лампочками LEDS-C4 / Kompatybilne tylko z żarówkami LEDS-C4

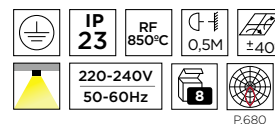
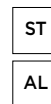
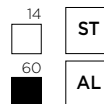
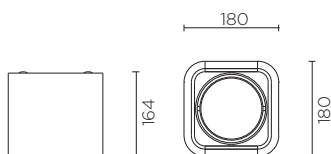

QR-111*

G53

A**... C



DM-1100-14-00	<input type="checkbox"/>	max. 75W			9-11
DM-1100-60-00	<input checked="" type="checkbox"/>				

AR-111 LED

G53 (max. H=77 mm)

A*... A

90-3546-14-00	<input type="checkbox"/>	max. 15W			22-25
90-3546-60-00	<input checked="" type="checkbox"/>				

Solo compatible con bombillas LEDS-C4 / Only compatible with LEDS-C4 bulbs / Uniquement compatible avec des ampoules LEDS-C4 / Nur mit LEDS-C4-Lampen kompatibel / Compatibile soltanto con lampadine LEDS-C4 / Compatível apenas com lâmpadas LEDS-C4 / Совместимы только с лампочками LEDS-C4 / Kompatybilne tylko z żarówkami LEDS-C4

* Versiones de descarga a consultar / Discharge lamps versions upon request / Versions à décharge sur demande / Ausführungen mit Entladungslampen auf Anfrage / Versioni su richiesta per lampade scarica / Versões para lâmpada de descarga mediante consulta / O моделях с разрядными лампами спрашивайте дополнительно / Wersje lamp wyładowczych do skonsultowania

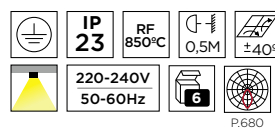
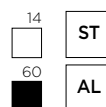
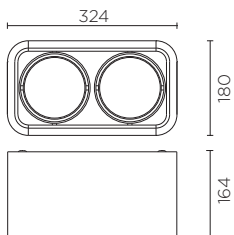

QR-111 *

G53	DM-1101-14-00	<input type="checkbox"/>	2 x max. 75W		
A+... C	DM-1101-60-00	<input type="checkbox"/>			



AR-111 LED

G53 (max. H=77 mm)	90-3547-14-00	<input type="checkbox"/>	2 x max. 15W		
A+... A	90-3547-60-00	<input type="checkbox"/>			

Solo compatible con bombillas LEDS-C4 / Only compatible with LEDS-C4 bulbs / Uniquement compatible avec des ampoules LEDS-C4 / Nur mit LEDS-C4-Lampen kompatibel / Compatibile soltanto con lampadine LEDS-C4 / Compatível apenas com lâmpadas LEDS-C4 / Совместимы только с лампочками LEDS-C4 / Kompatybilne tylko z żarówkami LEDS-C4

Accesorios / Accessories / Accessoires / Zubehöre / Accessori / Acessórios / Аксессуары / Akcesoria

PARA CÓDIGO / FOR CODE
POUR CODE / FÜR ARTIKEL-NR /
PER CODICE / PARA CÓDIGO /
ДЛЯ АРТИКУЛА / DLA KODU



ACT-9044-14-00	<input type="checkbox"/>	DM-1100 90-3546	Kit suspensión + 1 sirga / Suspension kit + 1 steel cable / Kit suspension + 1 câble de suspension / Aufhängekit + 1 Stahlkabel / Kit sospensione + 1 cavo / Kit de suspensão + 1 cabo de suspensão / Набор для подвешного монтажа + 1 трос / Zestaw do zawieszania + 1 linka
ACT-9044-60-00	<input type="checkbox"/>		
ACT-9045-14-00	<input type="checkbox"/>	DM-1101 90-3547	Kit suspensión + 2 sirgas / Suspension kit + 2 steel cable / Kit suspension + 2 câble de suspension / Aufhängekit + 2 Stahlkabel / Kit sospensione + 2 cavi / Kit de suspensão + 2 cabos de suspensão / Набор для подвешного монтажа + 2 троса / Zestaw do zawieszania + 2 linka
ACT-9045-60-00	<input type="checkbox"/>		

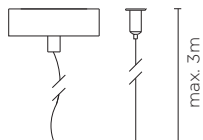



TECHNICAL

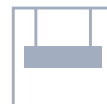

LINEAL LIGHTING SYSTEMS

SISTEMAS LINEALES DE ILUMINACIÓN
 SYSTÈMES D'ÉCLAIRAGE LINÉAIRES
 LINEARE BELEUCHTUNGSSYSTEME
 SISTEMI LINEARI D'ILLUMINAZIONE
 SISTEMAS LINEARES DE ILUMINAÇÃO
 ЛИНЕЙНЫЕ СИСТЕМЫ ОСВЕЩЕНИЯ
 LINIOWE SYSTEMY OŚWIETLENIOWE



INFINITE

P. 166



INFINITE C

P. 158



INFINITE LED

P. 164



INFINITE C LED

P. 160

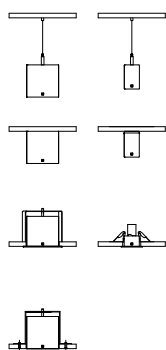

	P. 166	P. 158	P. 164	P. 160
	■	■	■	■
	■	■	■	■
	■	■	■	■
	■	■		
1 x TL5/G5	■	■		
2 x TL5/G5	■	■		
LED			■	■
39W (900mm)	■			
28W (1134mm)			■	
54W (1200mm)	■			
80W (1500mm)	■			
XXXX mm		■		■
	■			
	■	■	■	■
	■			
	■	■	■	■
	■	■	■	■
	■	■	■	■
	■	■	■	■
	■	■	■	■
	■	■	■	■
	■	■	■	■
	■	■	■	■
	■	■	■	■
	■	■	■	■
	■	■	■	■
	■	■	■	■
	■	■	■	■
	■	■	■	■
	■	■	■	■
	■	■	■	■
	■	■	■	■
	■	■	■	■
	■	■	■	■
	■	■	■	■
	■	■	■	■
	■	■	■	■
	■	■	■	■
	■	■	■	■
	■	■	■	■
	■	■	■	■
	■	■	■	■
	■	■	■	■
	■	■	■	■
	■	■	■	■
	■	■	■	■
	■	■	■	■
	■	■	■	■
	■	■	■	■
	■	■	■	■
	■	■	■	■
	■	■	■	■
	■	■	■	■
	■	■	■	■
	■	■	■	■
	■	■	■	■
	■	■	■	■
	■	■	■	■
	■	■	■	■
	■	■	■	■
	■	■	■	■
	■	■	■	■
	■	■	■	■
	■	■	■	■
	■	■	■	■
	■	■	■	■
	■	■	■	■
	■	■	■	■
	■	■	■	■
	■	■	■	■
	■	■	■	■
	■	■	■	■
	■	■	■	■
	■	■	■	■
	■	■	■	■
	■	■	■	■
	■	■	■	■
	■	■	■	■
	■	■	■	■
	■	■	■	■
	■	■	■	■
	■	■	■	■
	■	■	■	■
	■	■	■	■
	■	■	■	■
	■	■	■	■
	■	■	■	■
	■	■	■	■
	■	■	■	■
	■	■	■	■
	■	■	■	■
	■	■	■	■
	■	■	■	■
	■	■	■	■
	■	■	■	■
	■	■	■	■
	■	■	■	■
	■	■	■	■
	■	■	■	■
	■	■	■	■
	■	■	■	■
	■	■	■	■
	■	■	■	■
	■	■	■	■
	■	■	■	■
	■	■	■	■
	■	■	■	■
	■	■	■	■



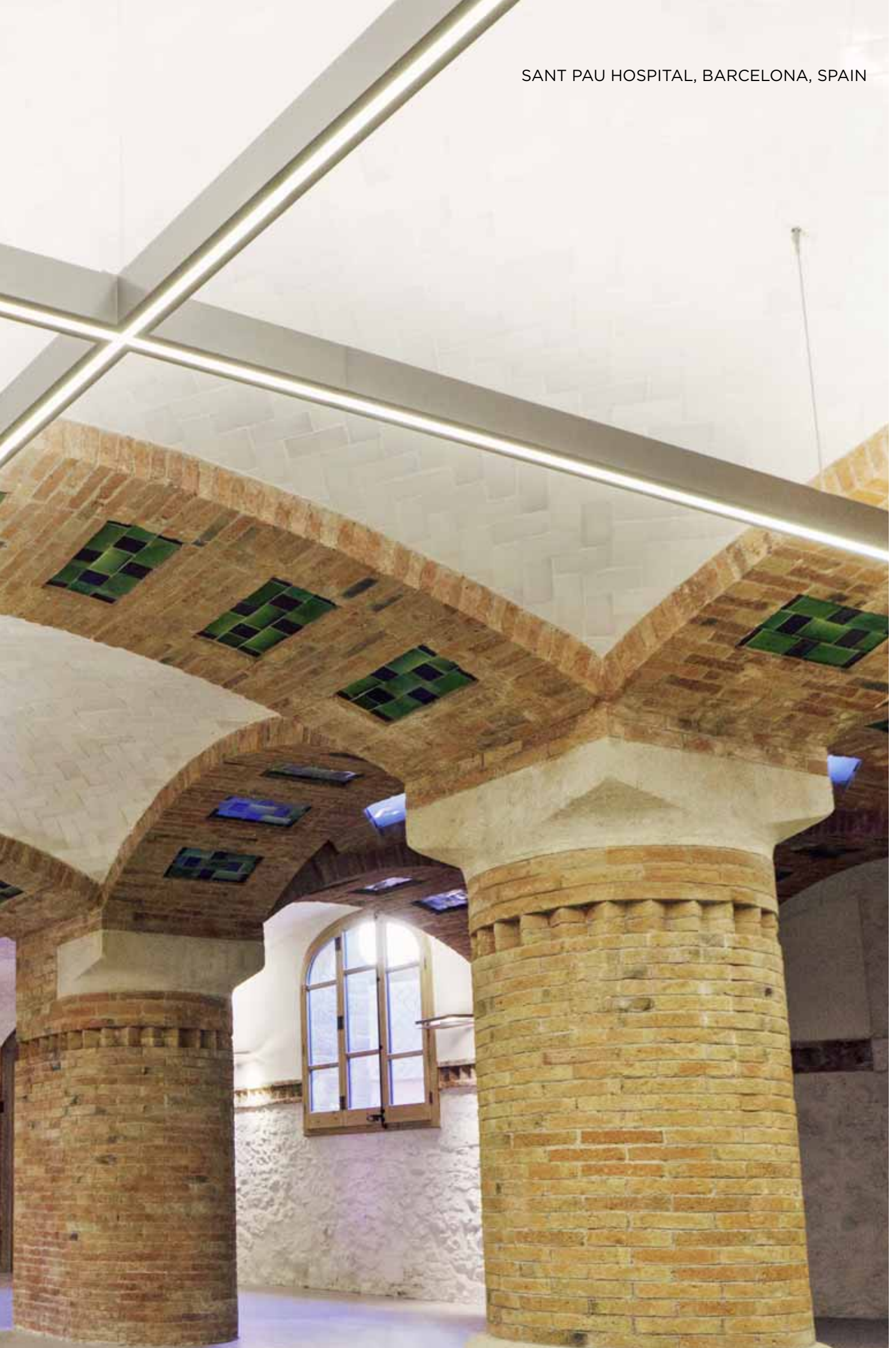

INFINITE C LED





INFINITE C LED

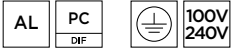

Suspendida / Suspended / En suspension / Hängelampe / A sospensione / Suspensa / Подвесной / Zwieszana

Adosada / Surface mounted / En surface / Aufbau / Montata in superficie / Montada em superficie / Поверхностный / Natynkowa

Empotrada trim / Recessed with trim / Encastré « trim » / Trim-Einbau / Einbauleuchte mit Rahmen / Incasso trim / Encastrada com aro / Встроенный с рамкой / Wbudowana typu trim (z obrzeżem)

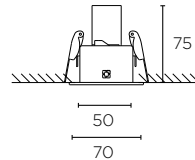
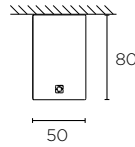
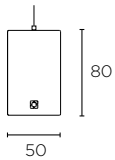
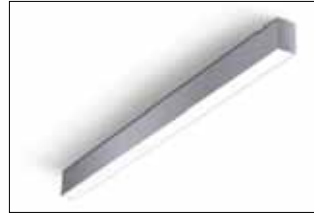
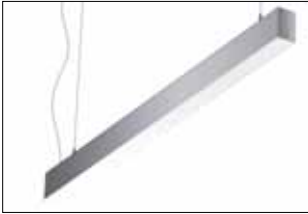

ELIGE TU COLOR
CHOOSE YOUR COLOUR



Posibilidad de ofrecer diferentes acabados, bajo pedido. Consulte con nuestro equipo comercial.
Possibility to offer different finishes, upon request. Get in contact with our sales team.
Possibilité de différentes finitions sur commande. Consultez notre équipe commerciale.
Andere Oberflächengestaltungen auf Anfrage. Unsere Vertriebsmitarbeiter beraten Sie gern.
Possibilità di offrire diverse rifiniture, su richiesta. Rivolgersi al nostro staff commerciale.
Possibilidade de oferecer diferentes acabamentos, sob pedido. Consulte a nossa equipa comercial.
Возможность предложить различные варианты отделки, по заказу. Обращайтесь в наш коммерческий отдел.
Możliwość zaoferowania różnego wykończenia na zamówienie. Proszę skontaktować się z naszym Działem Handlowym.

INFINITE C



Suspendida / Suspended / En suspension / Hängelampe / A sospensione / Suspensa / Подвесной / Zwieszana

Adosada / Surface mounted / En surface / Aufbau / Montata in superficie / Montada em superficie / Поверхностный / Natynkowa

Empotrada trimless / Trimless recessed / Encastré « trimless » / Einbauleuchte ohne Rahmen / Incasso trimless / Encastrada sem aro / Встроенный рамки / Wbudowana typu trimless (bez obrzeża)

Empotrada trim / Recessed with trim / Encastré « trim » / Trim-Einbau / Einbauleuchte mit Rahmen / Incasso trim / Encastrada com aro / Встроенный с рамкой / Wbudowana typu trim (z obrzeżem)

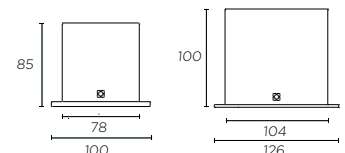
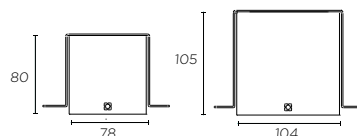
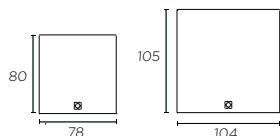
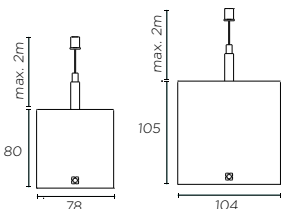
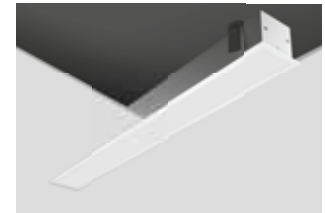
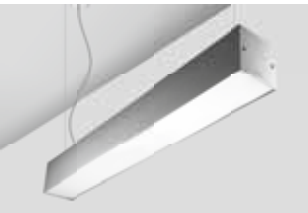

INFINITE C LED / INFINITE C

STEP 1

Elija la fuente de luz / Choose the light source / Choisissez la source lumineuse / Lichtquelle auswählen / Scelga la fonte di luce / Escolha a fonte de luz / Выберите источник света / Wybierz źródło światła

STEP 2

Elija su aplicación / Choose your application / Choisissez votre application / Montageart wählen / Scegliere l'applicazione / Escolha a sua aplicação / Выберите тип монтажа / Proszę wybrać swoje zastosowanie

STEP 3

Elija la longitud que necesite en milímetros (5 dígitos) / Choose the length required in millimeters (5 digits) / Choisissez la longueur nécessaire en millimètres (5 chiffres) / Länge in mm wählen (5 Stellen) / Escolha o comprimento necessário em milímetros (5 dígitos) / Scegliere la lunghezza necessaria in millimetri (5 cifre) / Выберите необходимую длину в мм (5 знаков) / Proszę wybrać żądaną w milimetrach (5 cyfr)

STEP 4

Haga su pedido / Place your order / Passez commande / Bestellung aufgeben / Faça a sua encomenda / Effettuare l'ordine / Оформите заказ / Proszę wykonać zamówienie

CÓDIGO / CODE / CODE / ARTIKEL-NR / CODICE / CÓDIGO / АРТИКУЛА / KODU

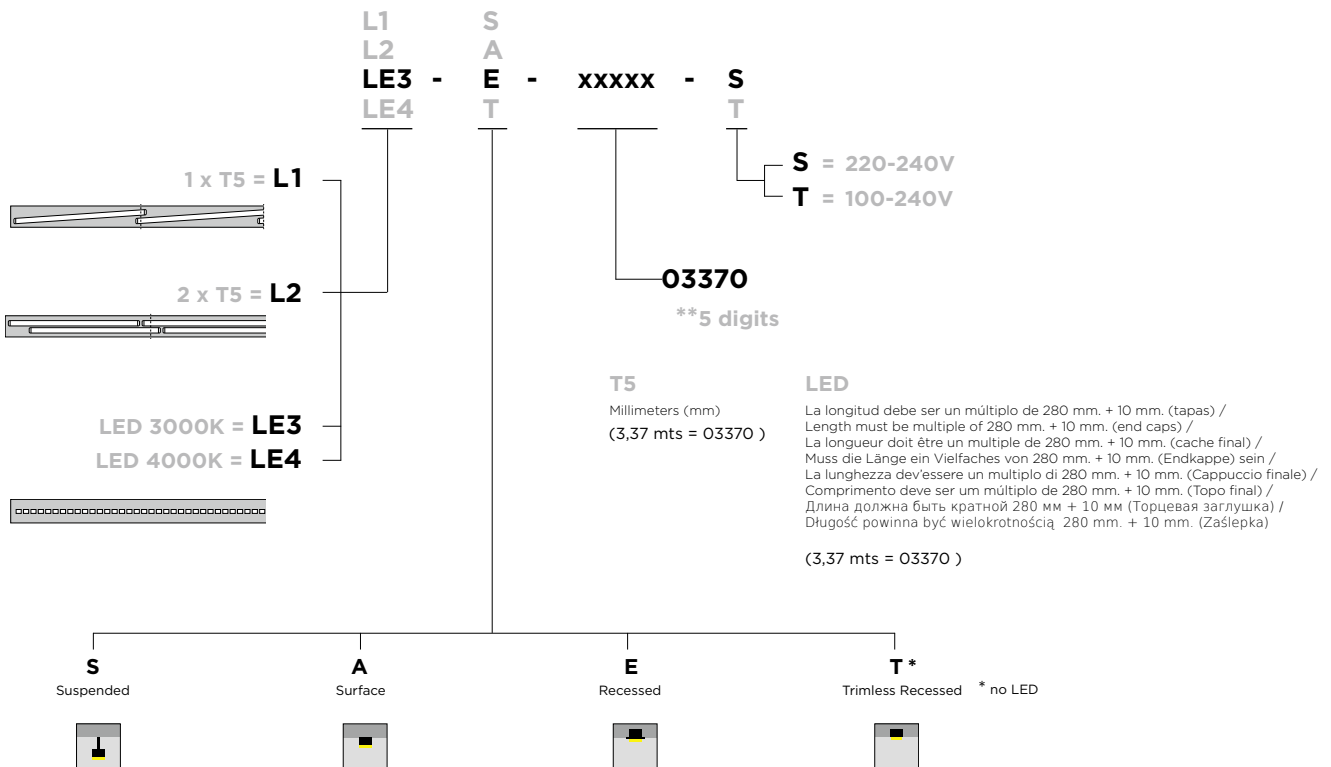



INFINITE LED

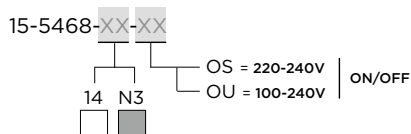
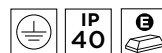

LED

A**... A	14	N3	OS	OU	3000K	4000K	2920lm	3190lm	3890lm	4250lm	5830lm	6370lm
15-5468												
15-5469	14		OS									
15-4797	-	-										
15-4798												
15-5470		N3		OU								
15-5471												



71-4911-N3-00

Sargas / Steel cord / Câble de suspension / Cabos de suspensão / Cavi in acciaio / Stahlkabel / Тросы / Liny



+



71-4834-14-00

71-4834-N3-00

Florón / Power supply unit / Base d'alimentation / Netzteil / Base de alimentação / Base alimentazione / Защитно-декоративный колпачок / Podsufitka



INFINITE LED

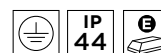
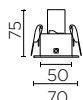

LED

A**... A	14	N3	OS	OU	3000K	4000K	2920lm	3190lm	3890lm	4250lm	5830lm	6370lm
90-5472												
90-5473	14		OS									
90-4799	-	-										
90-4800												
90-5474		N3		OU								
90-5475												

Accesorios / Accessories / Accessoires / Zubehöre / Accessori / Acessórios / Аксессуары / Akcesoria



71-4923-00-00

Kit unión perfil / Profile union kit / Kit de raccord profil / Verbindungskit
 Profil / Kit di unione profilo / Kit de união perfil / Набор соединительный
 для профиля / Zestaw łączący profil

ELIGE TU COLOR
 CHOOSE YOUR COLOUR



Posibilidad de ofrecer diferentes acabados, bajo pedido. Consulte con nuestro equipo comercial.
 Possibility to offer different finishes, upon request. Get in contact with our sales team.
 Possibilité de différentes finitions sur commande. Consultez notre équipe commerciale.
 Andere Oberflächengestaltungen auf Anfrage. Unsere Vertriebsmitarbeiter beraten Sie gern.
 Possibilità di offrire diverse rifiniture, su richiesta. Rivolgersi al nostro staff commerciale.
 Possibilidade de oferecer diferentes acabamentos, sob pedido. Consulte a nossa equipa comercial.
 Возможность предложить различные варианты отделки, по заказу. Обращайтесь в наш коммерческий отдел.
 Możliwość zaoferowania różnego wykończenia na zamówienie. Proszę skontaktować się z naszym Działem Handlowym.

INFINITE

1XT5

A**... C

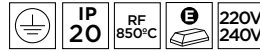

TRIMLESS REFERENCE = AD-xxxx-xx-xx Adosado / Surface mounted / En surface / Aufbaumontage / Montata in superficie / Montada em superficie / Поверхностный / Natynkowa	TRIMLESS REFERENCE + + = AD-xxxx-xx-xx Suspendido / Suspended / En suspension / Aufhängung / A sospensione / Suspensa / Подвесной / Zwieszana	TRIMLESS REFERENCE + = AD-xxxx-xx-xx Empotrada trimless / Trimless recessed / Encastré « trimless » / Einbaumontage ohne Rahmen / Ad incasso trimless / Encastrada sem aro / Встроенный без рамки / Wbudowana typu trimless (bez obrzeża).	TRIM REFERENCE = EP-xxxx-xx-xx Empotrada trim / Recessed with trim / Encastré « trim » / Einbauleuchte mit Rahmen / A incasso trim / Encastrada com aro / Встроенная с рамкой / Wbudowana typu trim (z obrzeżem)
---	--	---	--

ACCESSORIES

Watts			Finishing	Reference	+								
39W 900 mm	TRIMLESS		-	PC	■	AD-0659-N3-00	O	S	R	A	C	F	
			-	DP	■	AD-0656-N3-00	O	S	R	A	-	F	
			1-10V	PC	■	AD-0683-N3-00	D	S	R	A	C	F	
			1-10V	DP	■	AD-0680-N3-00	D	S	R	A	-	F	
			DALI	PC	■	AD-0694-N3-00	D	S	R	A	C	F	
			DALI	DP	■	AD-0691-N3-00	D	S	R	A	-	F	
	54W 1200 mm	TRIMLESS		-	PC	□	EP-1620-14-00	-	-	-	B	E	-
				-	DP	□	EP-1617-14-00	-	-	-	B	-	-
				1-10V	PC	□	EP-1643-14-00	-	-	-	B	E	-
				1-10V	DP	□	EP-1640-14-00	-	-	-	B	-	-
				DALI	PC	□	EP-1654-14-00	-	-	-	B	E	-
				DALI	DP	□	EP-1651-14-00	-	-	-	B	-	-
80W 1500 mm		TRIMLESS		-	PC	□	AD-0660-14-00	O	S	R	A	C	F
				-	DP	■	AD-0660-N3-00	D	S	R	A	C	F
				-	DP	□	AD-0657-14-00	O	S	R	A	-	F
				-	DP	■	AD-0657-N3-00	O	S	R	A	-	F
				1-10V	PC	□	AD-0684-14-00	D	S	R	A	C	F
				1-10V	DP	■	AD-0684-N3-00	D	S	R	A	C	F
	80W 1500 mm	TRIMLESS		1-10V	DP	□	AD-0681-14-00	D	S	R	A	-	F
				1-10V	DP	■	AD-0681-N3-00	D	S	R	A	-	F
				DALI	PC	□	AD-0695-14-00	D	S	R	A	C	F
				DALI	DP	■	AD-0695-N3-00	O	S	R	A	C	F
				DALI	DP	□	AD-0692-14-00	D	S	R	A	-	F
				DALI	DP	■	AD-0692-N3-00	D	S	R	A	-	F
80W 1500 mm		TRIM		-	PC	□	EP-1621-14-00	-	-	-	B	E	-
				-	DP	□	EP-1618-14-00	-	-	-	B	-	-
				1-10V	PC	□	EP-1644-14-00	-	-	-	B	E	-
				1-10V	DP	□	EP-1641-14-00	-	-	-	B	-	-
				DALI	PC	□	EP-1655-14-00	-	-	-	B	E	-
				DALI	DP	□	EP-1652-14-00	-	-	-	B	-	-
	80W 1500 mm	TRIMLESS		-	PC	■	AD-0661-N3-00	D	S	R	A	C	F
				-	DP	■	AD-0658-N3-00	O	S	R	A	-	F
				1-10V	PC	■	AD-0685-N3-00	D	S	R	A	C	F
				1-10V	DP	■	AD-0682-N3-00	D	S	R	A	-	F
				DALI	PC	■	AD-0696-N3-00	D	S	R	A	C	F
				DALI	DP	■	AD-0693-N3-00	D	S	R	A	-	F
80W 1500 mm		TRIM		-	PC	□	EP-1622-14-00	-	-	-	B	E	-
				-	DP	□	EP-1619-14-00	-	-	-	B	-	-
				1-10V	PC	□	EP-1645-14-00	-	-	-	B	E	-
				1-10V	DP	□	EP-1642-14-00	-	-	-	B	-	-
				DALI	PC	□	EP-1656-14-00	-	-	-	B	E	-
				DALI	DP	□	EP-1653-14-00	-	-	-	B	-	-

PC

Policarbonato /
 Polycarbonate /
 Polycarbonate /
 Polykarbonat /
 Policarbonato /
 Polycarbonato /
 Поликарбонат /
 Poliweglan

DP

Doble parabólica /
 Double parabolic /
 Double parabolé /
 Doppelparabol /
 Doppia parabola /
 Dupla parabólica /
 Двойной параболический /
 Podwójna parabola

Accesorios / Accessories / Accessoires / Zubehöre / Accessori / Acessórios / Аксессуары / Akcesoria



2.5m

Florón /
 Power supply unit /
 Base d'alimentation /
 Netzteil /
 Base d'alimentazione /
 Base de alimentação /
 Защитно-декоративный колпачок /
 Podsufitka

ACT-9090-14-00 (Standard)
 ACT-9090-N3-00 (Standard)

ACT-9083-N3-00 (1-10V or DALI)



2m

Sirgas /
 Steel cord /
 Câble de suspension /
 Stahlkabel /
 Cavi in acciaio /
 Cabos de suspensão /
 Тросы /
 Liny

ACT-9091-N3-00 2 units/ref



Kit para empotrar perfil trimless /
 Trimless recessed kit /
 Kit d'encastrement profil « trimless » /
 Einbaukit Profil ohne Rahmen /
 Kit per incasso profilo trimless /
 Kit para encastrar o perfil sem aro /
 Набор для встроенного монтажа профиля без рамки /
 Zestaw do wbudowania profili typu trimless (bez obrzeża)

ACT-9092-00-00 2 units/ref



Kit unión perfil /
 Profile union kit /
 Kit de raccord profil /
 Verbindungskit Profil /
 Kit di unione profilo /
 Kit de união perfil /
 Набор соединительный для профиля /
 Zestaw łączący profil

ACT-9114-00-00

ACT-9096-00-00

PC
 DIF

Conector 90° con difusor policarbonato /
 L-shape connector + PC cover /
 Connecteur 0° avec diffuseur polycarbonate /
 90-Grad-Stecker mit Diffusor aus Polykarbonat /
 Connettore 90° con diffusore di policarbonato /
 Conector 90° com difusor de policarbonato /
 Уголок соединительный L-образный с рассеивателем из поликарбоната /
 Złączka 90° z poliwęglanowym dyfuzorem

ACT-9150-14-M1
 ACT-9150-N3-M1

ACT-9152-14-M1

PC
 DIF

Conector T con difusor policarbonato /
 T-shape connector + PC cover /
 Connecteur en T avec diffuseur polycarbonate /
 T-Stecker mit Diffusor aus Polykarbonat /
 Connettore a T con diffusore di policarbonato /
 Conector T com difusor de policarbonato /
 Соединитель T-образный с рассеивателем из поликарбоната /
 Złączka w kształcie T z poliwęglanowym dyfuzorem

ACT-9154-14-M1
 ACT-9154-N3-M1

INFINITE

2XT5

A**... C



TRIMLESS REFERENCE = AD-xxxx-xx-xx Adosado / Surface mounted / En surface / Aufbaumontage / Montata in superficie / Montada em superficie / Поверхностный / Natynkowa	TRIMLESS REFERENCE + + = AD-xxxx-xx-xx Suspendido / Suspended / En suspension / Aufhängung / A sospensione / Suspensa / Подвесной / Zwieszana	TRIMLESS REFERENCE + = AD-xxxx-xx-xx Empotrada trimless / Trimless recessed / Encastré « trimless » / Einbaumontage ohne Rahmen / Ad incasso trimless / Encastrada sem aro / Встроенный без рамки / Wbudowana typu trimless (bez obrzeża).	TRIM REFERENCE = EP-xxxx-xx-xx Empotrada trim / Recessed with trim / Encastré « trim » / Einbauleuchte mit Rahmen / A incasso trim / Encastrada com aro / Встроенная с рамкой / Wbudowana typu trim (z obrzeżem)
---	--	---	--

ACCESSORIES

Watts			Finishing	Reference	+								
2x39W 900 mm	TRIMLESS		-	PC	■	AD-0665-N3-00	O	S	R	A	B	E	
			-	DP	■	AD-0662-N3-00	O	S	R	A	-	E	
			1-10V	PC	■	AD-0689-N3-00	D	S	R	A	B	E	
			1-10V	DP	■	AD-0686-N3-00	D	S	R	A	-	E	
			DALI	PC	■	AD-0700-N3-00	D	S	R	A	B	E	
			DALI	DP	■	AD-0697-N3-00	D	S	R	A	-	E	
	2x54W 1200 mm	TRIMLESS		-	PC	□	EP-1626-14-00	-	-	-	A	C	-
				-	DP	□	EP-1623-14-00	-	-	-	A	-	-
				1-10V	PC	□	EP-1649-14-00	-	-	-	A	C	-
				1-10V	DP	□	EP-1646-14-00	-	-	-	A	-	-
				DALI	PC	□	EP-1660-14-00	-	-	-	A	C	-
				DALI	DP	□	EP-1657-14-00	-	-	-	A	-	-
2x80W 1500 mm		TRIMLESS		-	PC	□	AD-0666-14-00	O	S	R	A	B	E
				-	DP	■	AD-0666-N3-00	D	S	R	A	B	E
				-	DP	□	AD-0663-14-00	O	S	R	A	-	E
				-	DP	■	AD-0663-N3-00	O	S	R	A	-	E
				1-10V	PC	□	AD-0690-14-00	D	S	R	A	B	E
				1-10V	DP	■	AD-0690-N3-00	D	S	R	A	B	E
	2x80W 1500 mm	TRIMLESS		-	PC	□	AD-0687-14-00	D	S	R	A	-	E
				-	DP	■	AD-0687-N3-00	D	S	R	A	-	E
				-	PC	□	AD-0701-14-00	D	S	R	A	B	E
				-	DP	■	AD-0701-N3-00	O	S	R	A	B	E
				DALI	PC	□	AD-0698-14-00	D	S	R	A	-	E
				DALI	DP	■	AD-0698-N3-00	D	S	R	A	-	E
TRIM			-	PC	□	EP-1627-14-00	-	-	-	A	C	-	
			-	DP	□	EP-1624-14-00	-	-	-	A	-	-	
			1-10V	PC	□	EP-1650-14-00	-	-	-	A	C	-	
			1-10V	DP	□	EP-1647-14-00	-	-	-	A	-	-	
			DALI	PC	□	EP-1661-14-00	-	-	-	A	C	-	
			DALI	DP	□	EP-1658-14-00	-	-	-	A	-	-	
TRIMLESS		-	DP	■	AD-0664-N3-00	O	S	R	A	-	-		
		1-10V	DP	■	AD-0688-N3-00	D	S	R	A	-	-		
		DALI	DP	■	AD-0699-N3-00	D	S	R	A	-	-		
		-	DP	□	EP-1625-14-00	-	-	-	A	-	-		
		1-10V	DP	□	EP-1648-14-00	-	-	-	A	-	-		
		DALI	DP	□	EP-1659-14-00	-	-	-	A	-	-		

PC

Policarbonato /
 Polycarbonate /
 Polycarbonate /
 Polykarbonat /
 Policarbonato /
 Polycarbonato /
 Поликарбонат /
 Poliweglan

DP

Doble parabólica /
 Double parabolic /
 Double parabole /
 Doppelparabol /
 Doppia parabola /
 Dupla parabólica /
 Двойной параболический /
 Podwójna parabola

Accesorios / Accessories / Accessoires / Zubehöre / Accessori / Acessórios / Аксессуары / Akcesoria



2.5m

Florón /
 Power supply unit /
 Base d'alimentation /
 Netzteil /
 Base d'alimentazione /
 Base de alimentação /
 Защитно-декоративный колпачок /
 Podsufitka

ACT-9090-14-00 (Standard)
 ACT-9090-N3-00

ACT-9083-N3-00 (1-10V or DALI)



2m

Sirgas /
 Steel cord /
 Câble de suspension /
 Stahlkabel /
 Cavi in acciaio /
 Cabos de suspensão /
 Тросы /
 Liny

ACT-9091-N3-00 2 units/ref



Kit para empotrar perfil trimless /
 Trimless recessed kit /
 Kit d'encastrement profil « trimless » /
 Einbaukit Profil ohne Rahmen /
 Kit per incasso profilo trimless /
 Kit para encastrar o perfil sem aro /
 Набор для встроенного монтажа профиля без рамки /
 Zestaw do wbudowania profili typu trimless (bez obrzeza)

ACT-9093-00-00 2 units/ref



Kit unión perfil /
 Profile union kit /
 Kit de raccord profil /
 Verbindungskit Profil /
 Kit di unione profilo /
 Kit de união perfil /
 Набор соединительный для профиля /
 Zestaw łączący profil

ACT-9097-00-00

PC
 DF

Conector 90° con difusor policarbonato /
 L-shape connector + PC cover /
 Connecteur 0° avec diffuseur polycarbonate /
 90-Grad-Stecker mit Diffusor aus Polykarbonat /
 Connettore 90° con diffusore di policarbonato /
 Conector 90° com difusor de policarbonato /
 Уголок соединительный L-образный с
 рассеивателем из поликарбоната /
 Złączka 90° z poliwęglanowym dyfuzorem

ACT-9151-14-M1
 ACT-9151-N3-M1

ACT-9153-14-M1

PC
 DF

Conector T con difusor policarbonato /
 T-shape connector + PC cover /
 Connecteur en T avec diffuseur polycarbonate /
 T-Stecker mit Diffusor aus Polykarbonat /
 Connettore a T con diffusore di policarbonato /
 Conector T com difusor de policarbonato /
 Соединитель T-образный с рассеивателем из поликарбоната /
 Złączka w kształcie T z poliwęglanowym dyfuzorem

ACT-9155-14-M1
 ACT-9155-N3-M1

INFINITE WALL WASHER

1XT5

A**... C

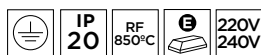

TRIMLESS

REFERENCE = **AD-XXXX-XX-XX**

Adosado / Surface mounted /
En surface / Aufbaumontage /
Montata in superficie / Montada
em superficie / Поверхностный /
Natynkowa

TRIMLESS

REFERENCE + + =

Suspendido / Suspended /
En suspension / Aufhängung /
A sospensione / Suspensa /
Подвесной / Zwieszana

TRIMLESS

REFERENCE + =

Empotrada trimless / Trimless recessed /
Encastré « trimless » / Einbaumontage ohne
Rahmen / Ad incasso trimless / Encastrada
sem aro / Встроенный без рамки /
Wbudowana typu trimless (bez obrzeża)

TRIM

REFERENCE = **EP-XXXX-XX-XX**

Empotrada trim / Recessed with trim /
Encastré « trim » / Einbauleuchte mit
Rahmen / A incasso trim / Encastrada
com aro / Встроенная с рамкой /
Wbudowana typu trim (z obrzeżem)

ACCESSORIES

Watts			Finishing	Reference				
54W		-	AR	AD-0654-N3-00	O	S	R	A
1200 mm		-		EP-1615-14-00	-	-	-	A



AR Reflector asimétrico /
Asymmetrical reflector /
Réflecteur asymétrique /
Asymmetrischer Reflektor /
Reflector assimétrico /
Riflettore asimmetrico /
Ассиметричный отражатель /
Asymetryczny odbłyśnik

Accesorios / Accessories / Accessoires / Zubehöre / Accessori / Acessórios / Аксессуары / Akcesoria



O ACT-9090-N3-00 **(Standard)**

Florón / Power supply unit /
Base d'alimentation / Netzteil /
Base d'alimentazione / Base de alimentação /
Защитно-декоративный колпачок / Podsufitka



S ACT-9091-N3-00 **2 units/ref**

Sirgas / Steel cord /
Câble de suspension / Stahlkabel /
Cavi in acciaio /
Cabos de suspensão /
Тросы / Liny



R ACT-9093-00-00 **2 units/ref**

Kit para empotrar perfil trimless /
Trimless recessed kit /
Kit d'encastrement profil « trimless » /
Einbaukit Profil ohne Rahmen /
Kit per incasso profilo trimless /
Kit para encastrar o perfil sem aro /
Набор для встроенного монтажа профиля без рамки /
Zestaw do wbudowania profilu typu trimless (bez obrzeża)



A ACT-9097-00-00

Kit unión perfil /
Profile union kit /
Kit de raccord profil /
Verbindungsprofil /
Kit di unione profilo /
Kit de união perfil /
Набор соединительный для профиля /
Zestaw łączący profil

TL5 G5 1x54W double parabolic

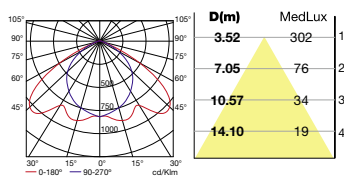

$\eta = 60\%$

TL5 G5 1x54W polycarbonate

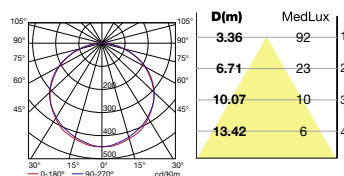

$\eta = 31\%$

TL5 G5 2x54W double parabolic

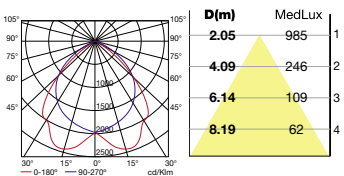

$\eta = 56\%$

TL5 G5 2x54W polycarbonate

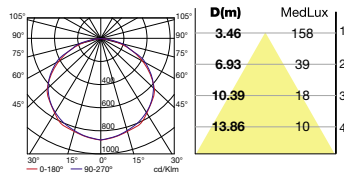

$\eta = 28\%$

TL5 G5 1x54W asymmetrical reflector

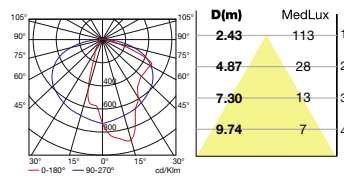

$\eta = 34\%$



PC

Policarbonato /
 Polycarbonate /
 Polycarbonate /
 Polykarbonat /
 Policarbonato /
 Policarbonato /
 Поликарбонат /
 Poliwęglan

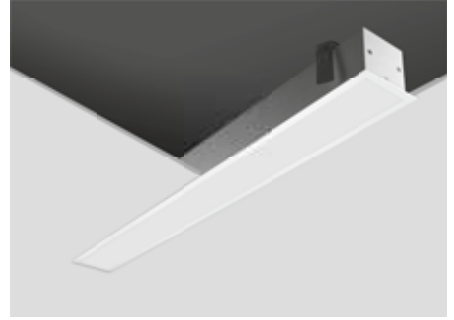
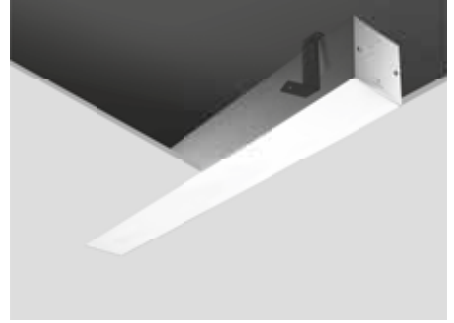

DP

Doble parabólica /
 Double parabolic /
 Double parabole /
 Doppelparabol /
 Doppia parabola /
 Dupla parabólica /
 Двойной параболический /
 Podwójna parabola

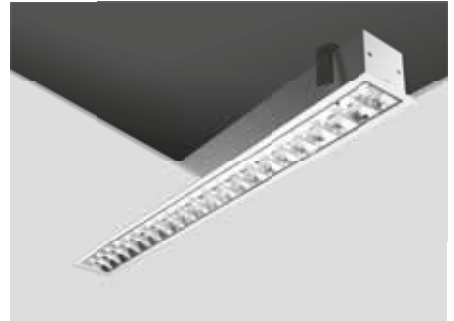
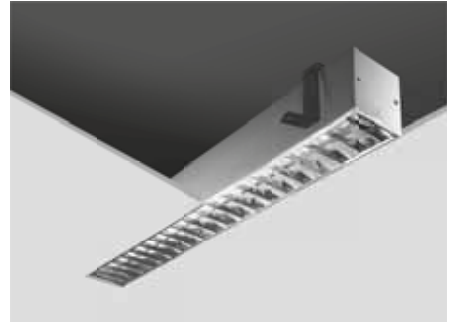

AR

Reflector asimétrico /
 Asymmetrical reflector /
 Réflecteur asymétrique /
 Asymmetrischer Reflektor /
 Reflector assimétrico /
 Riflettore asimmetrico /
 Ассиметричный отражатель /
 Asymetryczny odbłyśnik

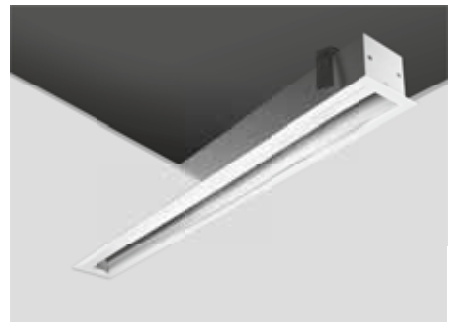
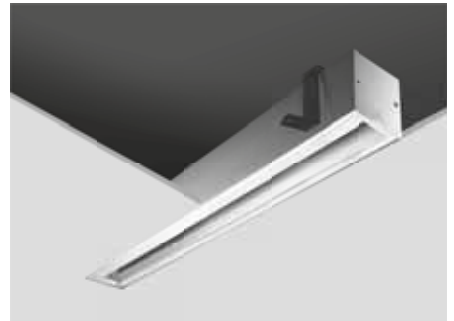

TECHNICAL



	P. 52	P. 123	P. 150	P. 154
E-27				
QR-111/G53	■		■	■
AR-111/GU10	■		■	
AR-111/G53				■
CDM-R111/GX8.5				■
HIT-T/G12	■			
HIT-TC/G8.5			■	
T5/G5				
LED	■	■	■	
	■	■ (1)	■	■

(1) Solo en algunas versiones / Only in some versions

PEK







PEK

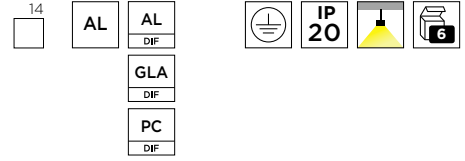
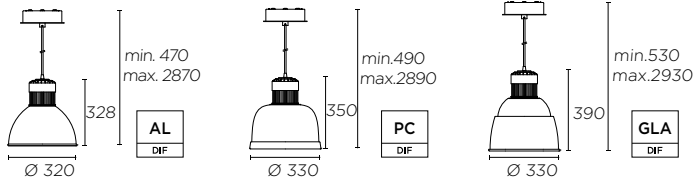

LED CREE
Zhaga Standard
A**... A

CRI 80

00-4941-14-00	<input type="checkbox"/>	3000K	3220lm	34,3W	100-240V 50-60Hz
00-4944-14-00	<input type="checkbox"/>	4000K			
00-4947-14-00	<input type="checkbox"/>	3000K	5120lm	53,2W	
00-4950-14-00	<input type="checkbox"/>	4000K			

CRI 90

00-4953-14-00	<input type="checkbox"/>	3000K	3880lm	53,2W	100-240V 50-60Hz
---------------	--------------------------	-------	--------	-------	---------------------

LED CRI80 3000K
53,2W

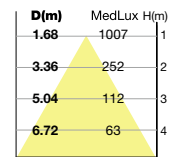
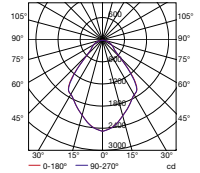

LED CREE
Zhaga Standard
A**... A

CRI 80

00-4942-14-M2	<input type="checkbox"/>	3000K	3220lm	34,3W	100-240V 50-60Hz
00-4945-14-M2	<input type="checkbox"/>	4000K			
00-4948-14-M2	<input type="checkbox"/>	3000K	5120lm	53,2W	
00-4951-14-M2	<input type="checkbox"/>	4000K			

CRI 90

00-4954-14-M2	<input type="checkbox"/>	3000K	3880lm	53,2W	100-240V 50-60Hz
---------------	--------------------------	-------	--------	-------	---------------------

LED CRI80 3000K
53,2W

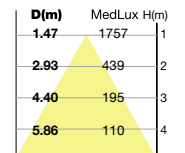
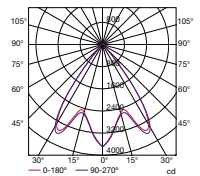

LED CREE
Zhaga Standard
A**... A

CRI 80

00-4943-14-B9	<input type="checkbox"/>	3000K	3220lm	34,3W	100-240V 50-60Hz
00-4946-14-B9	<input type="checkbox"/>	4000K			
00-4949-14-B9	<input type="checkbox"/>	3000K	5120lm	53,2W	
00-4952-14-B9	<input type="checkbox"/>	4000K			

CRI 90

00-4955-14-B9	<input type="checkbox"/>	3000K	3880lm	53,2W	100-240V 50-60Hz
---------------	--------------------------	-------	--------	-------	---------------------

LED CRI80 3000K
53,2W

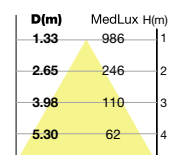
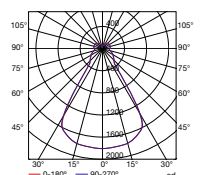





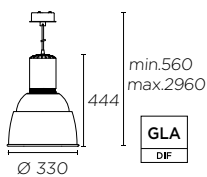
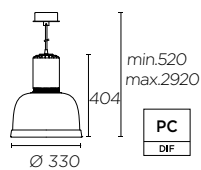
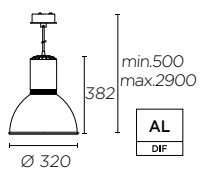

14



HIT-T

G12

A*... A

00-4956-14-00	<input type="checkbox"/>	35W	220-240V 50-60Hz
00-4959-14-00	<input type="checkbox"/>	70W	



HIT-T

G12

A*... A

00-4957-14-M2	<input type="checkbox"/>	35W	220-240V 50-60Hz
00-4960-14-M2	<input type="checkbox"/>	70W	



HIT-T

G12

A*... A

00-4958-14-B9	<input type="checkbox"/>	35W	220-240V 50-60Hz
00-4961-14-B9	<input type="checkbox"/>	70W	

Accesorios / Accessories / Accessoires / Zubehöre / Accessori / Acessórios / Аксессуары / Akcesoria

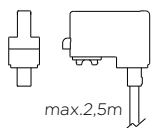

71-3531-60-00

Kit suspensión carril / Track suspended kit / Kit suspension / Aufhängekit / Kit sospensione / Kit de suspensão / Набор для подвешенного монтажа для шины / Zestaw do zawieszenia

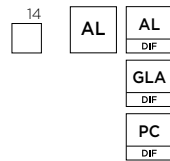
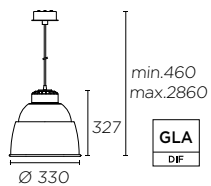
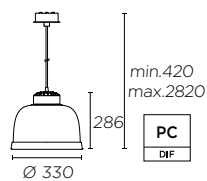
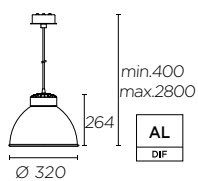

E-27

A**... C

00-4962-14-00



max. 100W



E-27

A**... C

00-4963-14-M2



max. 100W



E-27

A**... C

00-4964-14-B9



max. 100W

Accesorios / Accessories / Accessoires / Zubehöre / Accessori / Acessórios / Аксессуары / Akcesoria

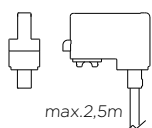

71-3531-60-00



Kit suspensión carril / Track suspended kit / Kit suspension / Aufhängekit / Kit sospensione / Kit de suspensão / Набор для подвешного монтажа для шины / Zestaw do zawieszania

TECHNICAL

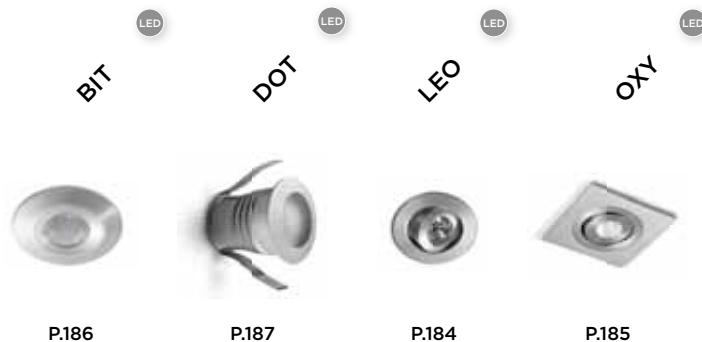

- Ø 31-40mm
- Ø 41-50mm
- Ø 51-60mm
- Ø 61-70mm
- Ø 91-100mm
- 71-80mm x 71-80mm
- 101-110mm x 101-110mm
- 161-170mm x 81-90mm
- 171-180mm x 141-150mm

P.186 P.187 P.184 P.185

LED Max. 2,2W Max. 2,2W Max. 2,2W Max. 2,2W

3000K ■ ■ ■ ■



15° ■ ■ ■ ■

25° ■ ■ ■ ■

40° ■ ■ ■ ■

HALO ■ ■ ■ ■

54-S2 ■ ■ ■ ■

S2 ■ ■ ■ ■

14 ■ ■ ■ ■

N3 ■ ■ ■ ■

IP20 ■ ■ ■ ■

IP23 ■ ■ ■ ■

IP43 ■ ■ ■ ■

IP50 ■ ■ ■ ■

IP54 ■ ■ ■ ■

IK02 ■ ■ ■ ■

IK03 ■ ■ ■ ■





LEO

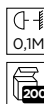
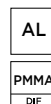
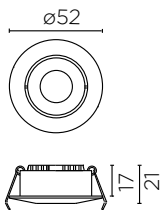

71-4813

LED CREE

A++... A

DN-0511-S2-00



3000K

max.170lm

max. 2,2W



P.682

LED 3000K 2,2W 15°

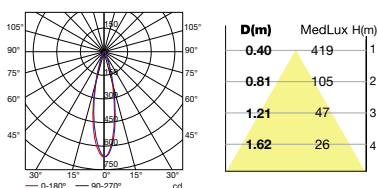

OXY

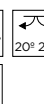
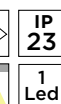
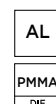
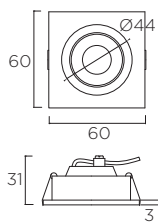

71-4813

LED CREE

A++... A

90-3489-54-S2



3000K

max.170lm

max. 2,2W



P.682

LED 3000K 2,2W 15°

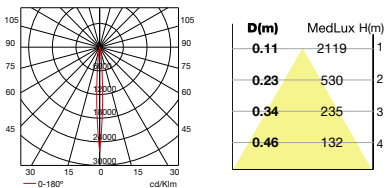

x1 x1

Set ópticas incluidas.
Set of lenses included.
Set de lentilles fourni.
Linsenset inklusiv.
Set di lenti incluso.
Conjunto de lentes incluido.
Включен набор оптических аксессуаров.
Łącznie z kompletem układu optycznego.

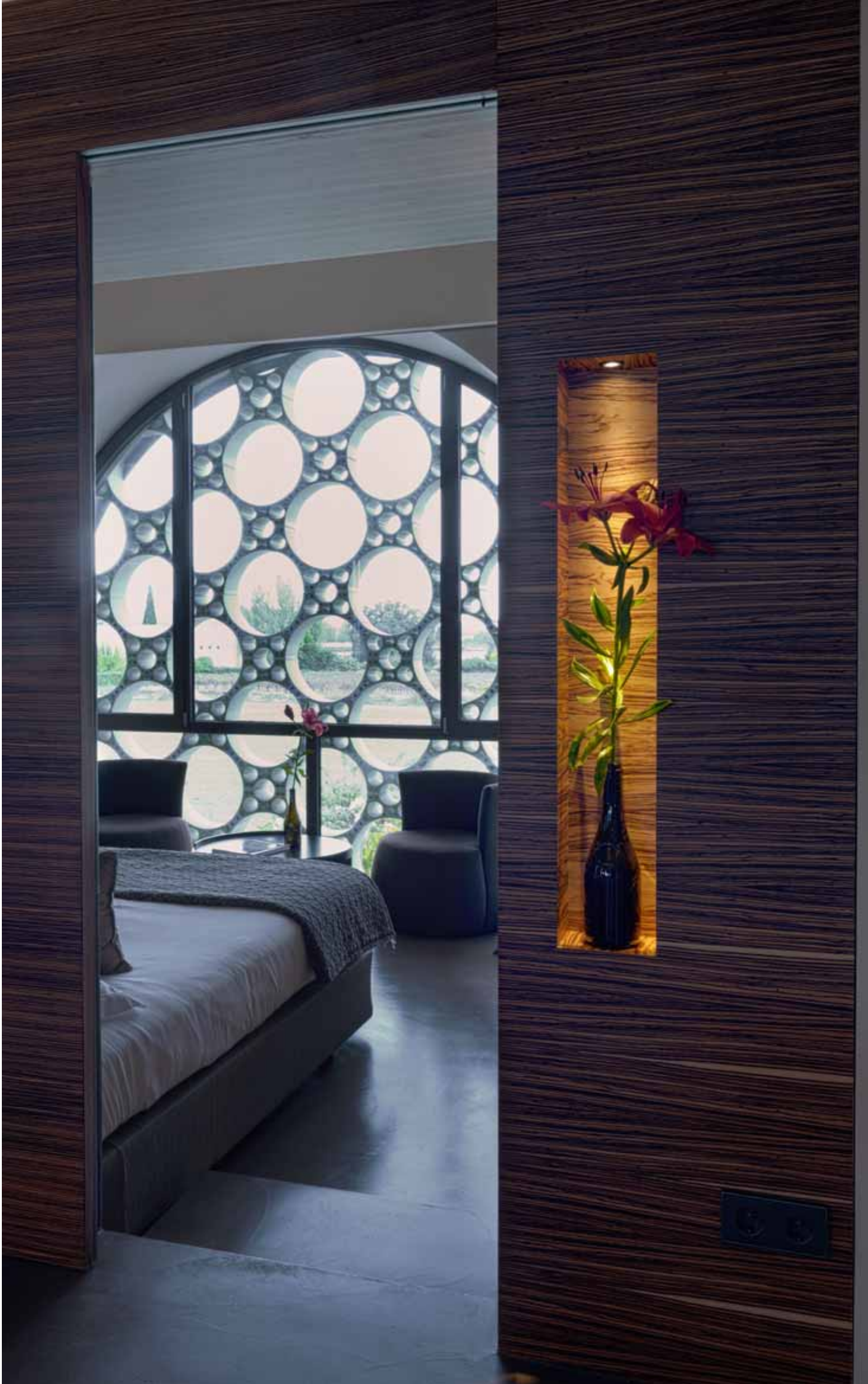

DOT

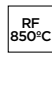
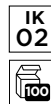
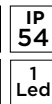
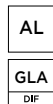
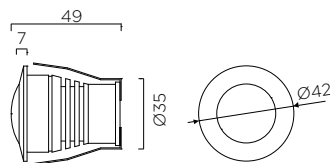

LED CREE

A**... A

05-3314-N3-B9



3000K

max. 170lm

max. 2,2W



LED 3000K 2,2W

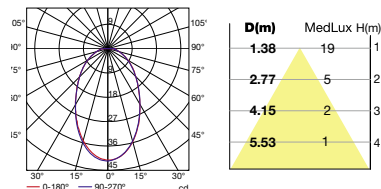

Accesorios / Accessories / Accessoires / Zubehöre / Accessori / Acessórios / Аксессуары / Akcesoria

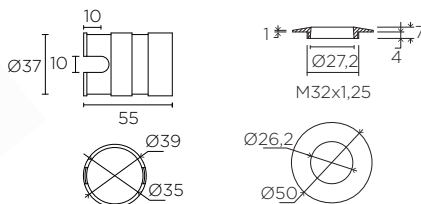

71-4661-N3-N3

Kit

BIT

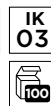
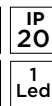
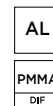
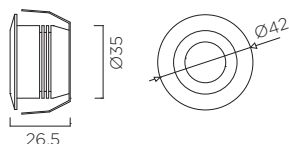

LED CREE

A**... A

05-3308-S2-00



3000K

max. 145lm

max. 2,2W



LED 3000K 2,2W 15°

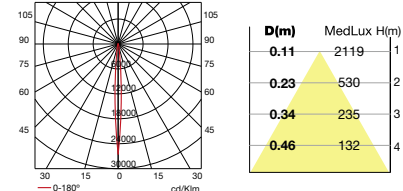

x 1 x 1

Set ópticas incluidas.
Set of lenses included.
Set de lentilles fourni.
Linsenset inklusiv.
Set di lenti incluso.
Conjunto de lentes incluido.
Включен набор оптических аксессуаров.
Łącznie z kompletem układu optycznego.



STEP

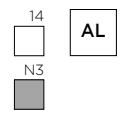
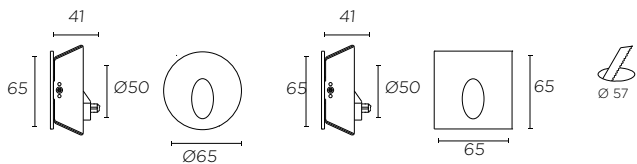

LED

A**... A	55-1573-14-00	<input type="checkbox"/>	3000K	250lm	2W	220V/240V	
	55-1573-N3-00	<input type="checkbox"/>					



LED

A**... A	55-1574-14-00	<input type="checkbox"/>	3000K	250lm	2W	220V/240V	
	55-1574-N3-00	<input type="checkbox"/>					



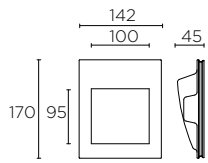

05-1808-14-00

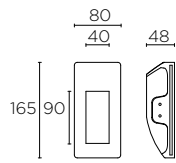

05-1804-14-00

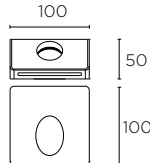

05-2904-14-00



PLASTER



IP 20

RF 850°C



1 Led



LED CREE

175 x 145

A+ ... A



05-1808-14-00		3000K	max. 100lm	max. 1W		max. 350 mA	
---------------	--	-------	------------	---------	--	-------------	--



LED CREE

170 x 85

A+ ... A



05-1804-14-00		3000K	max. 100lm	max. 1W		max. 350 mA	
---------------	--	-------	------------	---------	--	-------------	--



LED CREE

105 x 105

A+ ... A



05-2904-14-00		3000K	max. 100lm	max. 1W		max. 350 mA	
---------------	--	-------	------------	---------	--	-------------	--



SIGN

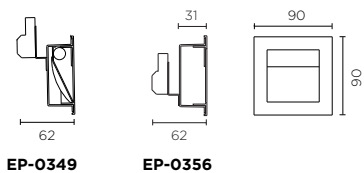

80 x 120
con caja / with box

77 x 77
sin caja / without box

14 AL

N3

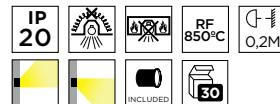

HALOPIN

G9	EP-0349-N3-XY	<input checked="" type="checkbox"/>	25W	-	-
A**... C	EP-0349-14-XY	<input type="checkbox"/>			



LED CREE

A**... A	EP-0356-N3-00	<input checked="" type="checkbox"/>	3000K	max. 170lm	max. 2,2W	DIMMING	max. 700 mA	B P.682
	EP-0356-14-00	<input type="checkbox"/>						



TECHNICAL

LED

		VDC	LUZ/ LIGHT/ CBET/ ŚWIATŁO	REFERENCIA/ REFERENCE/ АРТИКУЛ/ NR REFERENCYJNY	W/m	LEDS/m	IP	
ION	P.196	12VDC	WARM WHITE	91-3411-54-M2	7,2		68	
			WARM WHITE	91-3408-54-M2	14,4		68	
ON	P.196	24VDC	WARM WHITE	91-4671-00-00	4,8	60	20	
ON ECO	P.199	24VDC	WARM WHITE	91-0150-00-00	4,8	60	20	
ON IP ECO	P.198	24VDC	WARM WHITE	91-0175-00-00	4,8	60	65	
			COLD WHITE	91-0171-00-00	4,8	60	65	
			RGB	91-2491-00-00	7,2	30	65	
ON HP	P.200	24VDC	WARM WHITE	91-2361-00-00	9,6	120	20	
			WARM WHITE	91-3282-00-00	9,6	120	20	
			COLD WHITE	91-2365-00-00	9,6	120	20	
			RGB	91-2379-00-00	14,4	60	20	
ON HP IP	P.201	24VDC	WARM WHITE	91-4763-00-00	9,6	120	65	
ON SP	P.202	24VDC	WARM WHITE	91-4764-00-00	28	120	20	
ON SP IP	P.203	24VDC	WARM WHITE	91-4765-00-00	28	120	65	
ZENIT	P.203	24VDC	WW-CW	91-2492-00-00	9,6	60	65	
DEEP	P.204	24VDC	WARM WHITE	91-5452-00-00	14,4	60	67	
			RGB	91-5453-00-00	14,4	60	67	



LED STRIPS

TIRAS LED
BANDEAUX À LED
LED-BÄNDER
STRISCE LED
FITAS LED
СВЕТОДИОДНЫЕ ЛЕНТЫ
PASKI LED

CORTE / CUT / ШАГ СРЕЗА / PRZEKRÓJ (MM)

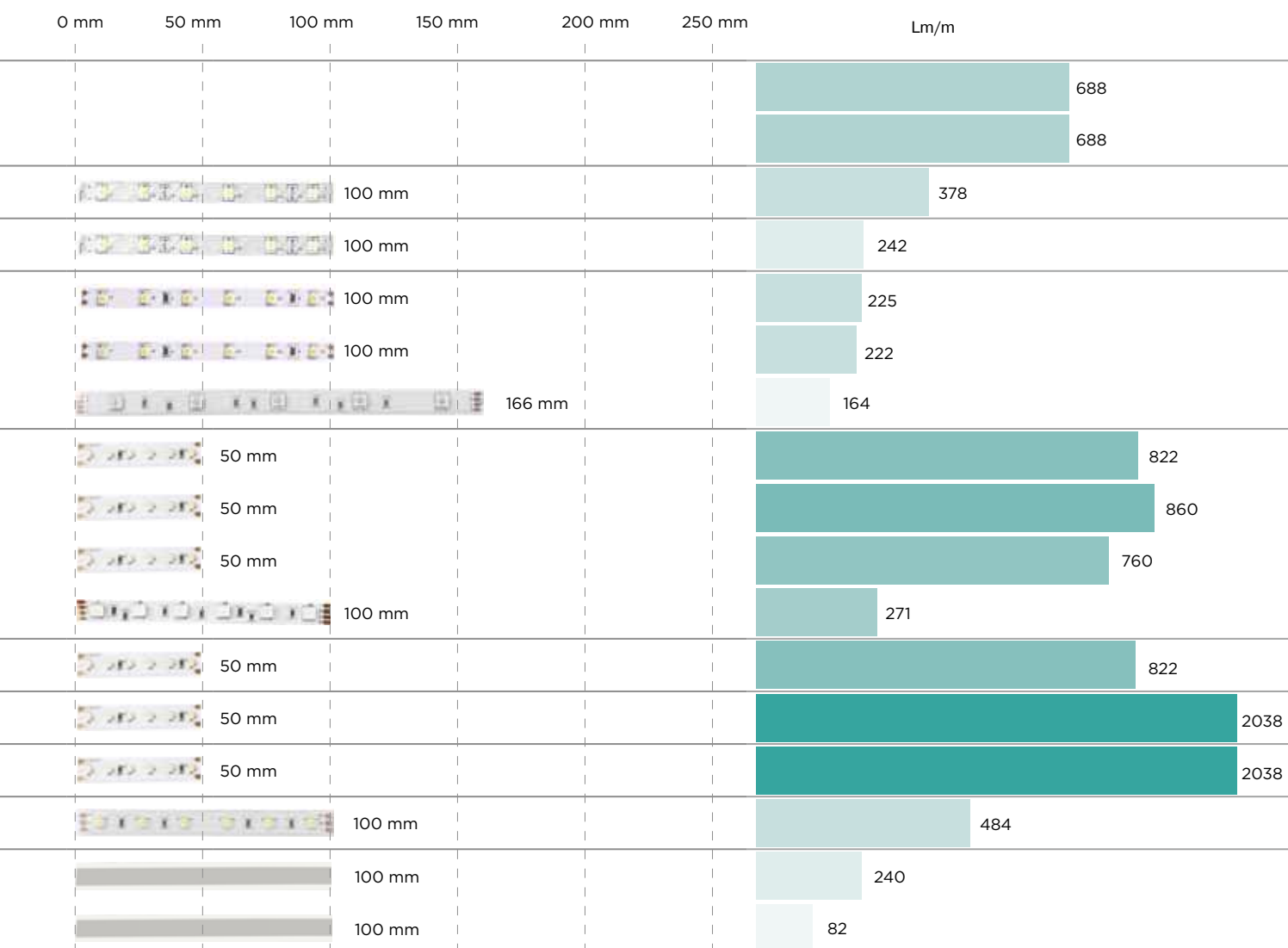

Consultar guías de instalación antes de realizar cualquier manipulación. / Consult installation guides before handling the product. / Consulter les guides d'installation avant toute manipulation. / Bitte lesen Sie vor der Montage die Installationsanleitungen. / Consultare la guida di installazione prima di installare il prodotto. / Consultar os guias de instalação antes de qualquer manuseamento. / До начала работы обязательно ознакомьтесь с инструкцией по монтажу. / Zapoznać się z instrukcjami zamontowania przed wykonaniem jakichkolwiek czynności.



ON

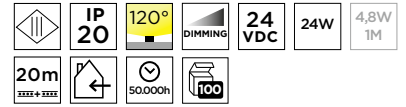
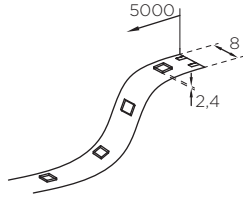

LED

A**... A

91-4671-00-00

3000K

1890 lm

24W

60 LED/m



Accesorios / Accessories / Accessoires / Zubehöre / Accessori / Acessórios / Аксессуары / Akcesoria

LINEAL

Perfil de 2m / 2 m profile / Profil de 2 m / 2 M Profil / Profili di 2 m / Calha de 2 m / Профиль 2 м / Profil 2m
 ver página / see page / voir page / siehe Seite / vedi pag. / ver página / Смотреть страницу / Zobacz stronę . 206

ION

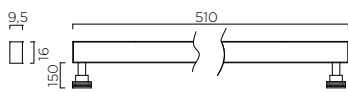
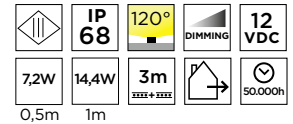
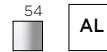

LED

A**... A



91-3411-54-M2



3000K

345 lm

7,2W

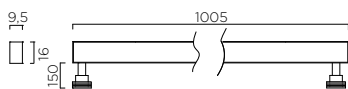

LED

A**... A



91-3408-54-M2



3000K

685 lm

14,4W



Accesorios / Accessories / Accessoires / Zubehöre / Accessori / Acessórios / Аксессуары / Akcesoria



71-3411-56-56

Accesorio para orientar la tira ION
 Accessory to adjust the ION strip
 Accessoire d'orientation du bandeau ION
 Zubehöre zur Ausrichtung von ION-Band
 Accessorio per orientare la striscia ION
 Acessório para orientar a tira ION
 Включает аксессуар для направляемости ленты ION
 Zawiera akcesorium do nastawiania oprawy ion

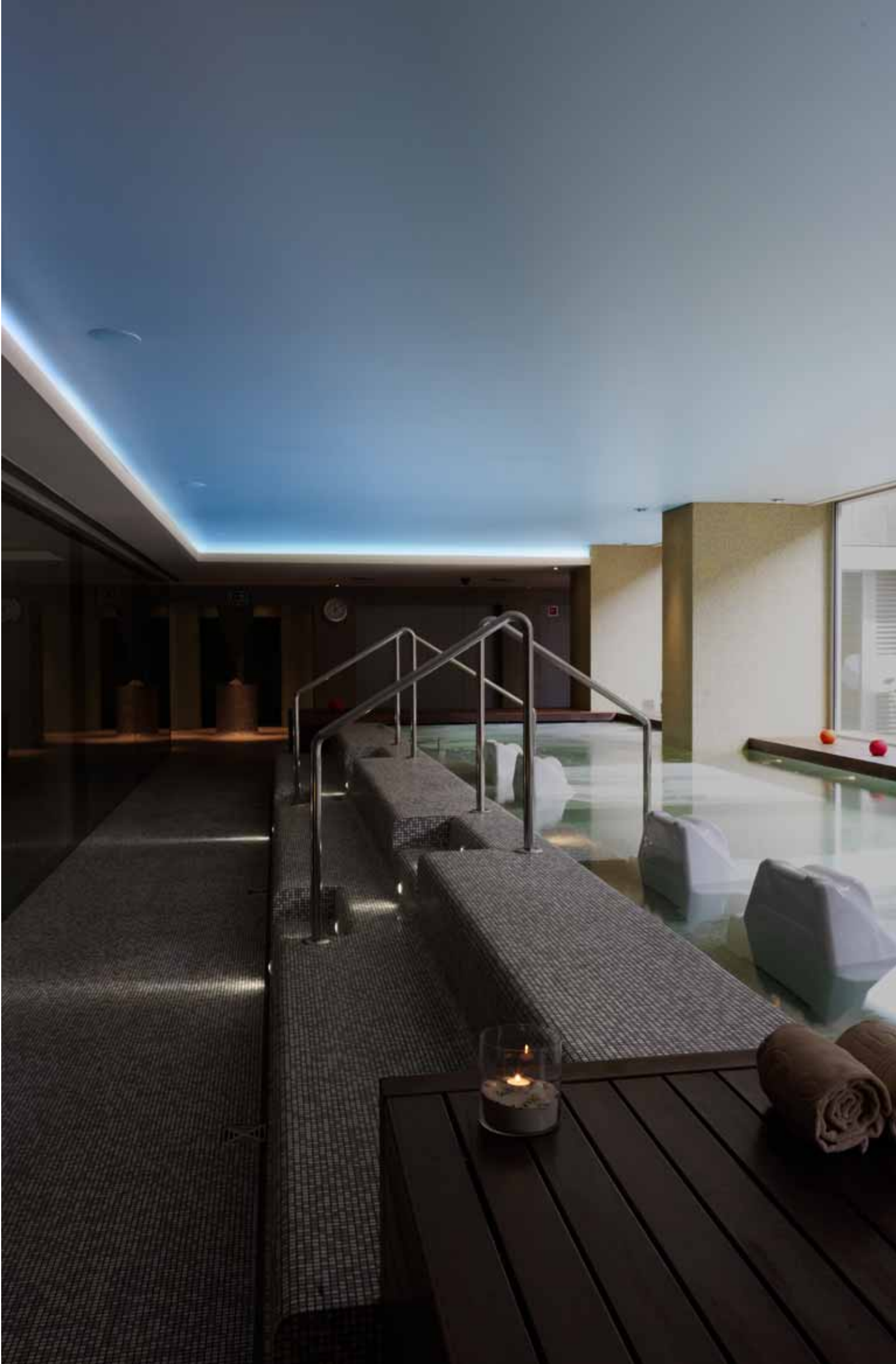



ON ECO

BASIC SOLUTION

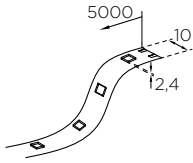

LED Eco

A**... A

91-0150-00-00

3000K

1210 lm

24W

60 LED/m



LED 3000K 24W

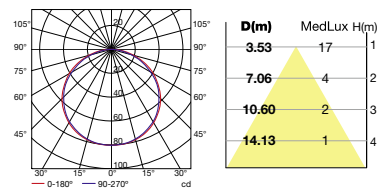

ON IP ECO

BASIC SOLUTION

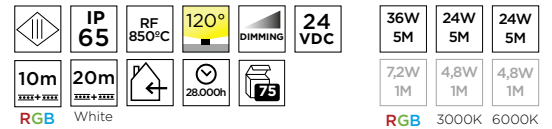
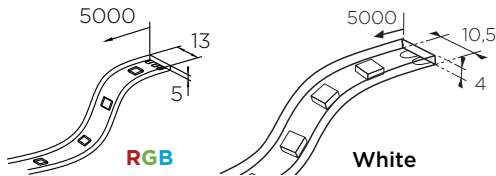

LED Eco

A**... A

91-2491-00-00

RGB

820 lm

36W

30LED/m



91-0175-00-00

3000K

1130 lm

24W

60LED/m

91-0171-00-00

6000K

1110 lm

LED RGB 36W

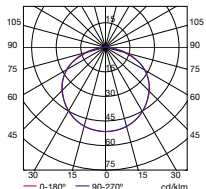

LED 3000K 24W

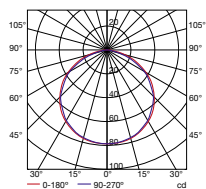

LED 6000K 24W

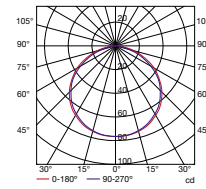

Accesorios / Accessories / Accessoires / Zubehöre / Accessori / Acessórios / Аксессуары / Akcesoria

LINEAL

Perfil de 2m / 2 m profile / Profil de 2 m / 2 M Profil / Profili di 2 m / Calha de 2 m / Профиль 2 м / Profil 2m
ver página / see page / voir page / siehe Seite / vedi pag. / ver página / Смотреть страницу / Zobacz stronę . 206





ON HP

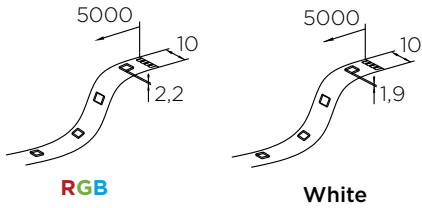

	IP 20		120°		DIMMING		24 VDC	72W 5M	48W 5M	48W 5M	48W 5M
	5m		10m		50.000h		50.000h	14,4W 1M	9,6W 1M	9,6W 1M	9,6W 1M
	RGB		White					RGB	3000k	2500k	6000k

LED

A**... A	91-2379-00-00	RGB	1360 lm	72W	60 LED/m	
	91-3282-00-00	2500K	4300 lm	48W	120 LED/m	
	91-2361-00-00	3000K	4110 lm			
	91-2365-00-00	6000K	3800 lm			

**equivalente a
as bright as
14,4W/m
ON HP
2014**

LED RGB 72W

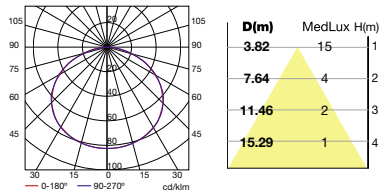

LED 2500K 48W

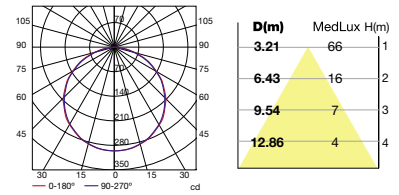

LED 3000K 48W

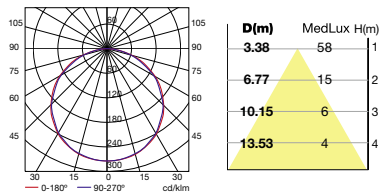

LED 6000K 48W

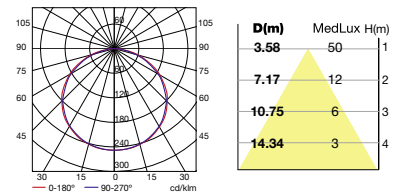

ON HP IP

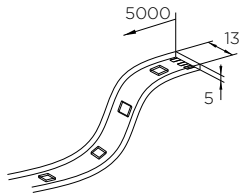

	IP 65		120°		DIMMING		24 VDC	48W 5M	9,6W 1M
	10m		50.000h		100				

LED

A**... A	91-4763-00-00	3000K	4110 lm	48W	120 LED/m	
----------	---------------	-------	---------	-----	-----------	--

Accesorios / Accessories / Accessoires / Zubehöre / Accessori / Acessórios / Аксессуары / Akcesoria

LINEAL

Perfil de 2m / 2 m profile / Profil de 2 m / 2 M Profil / Profili di 2 m / Calha de 2 m / Профиль 2 м / Profil 2m
ver página / see page / voir page / siehe Seite / vedi pag. / ver página / Смотреть страницу / Zobacz stronę . 206



XARELLO



ON SP

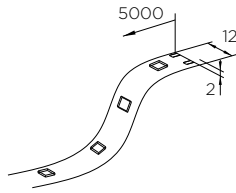

LED

A**... A

91-4764-00-00	3000K	10190 lm	140W	120 LED/m	 P684
---------------	-------	----------	------	-----------	---

ON SP IP

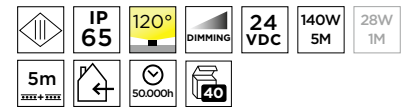
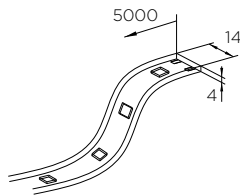

LED

A**... A

91-4765-00-00	3000K	10190 lm	140W	120 LED/m	 P684
---------------	-------	----------	------	-----------	---

ZENIT

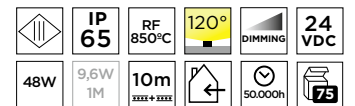
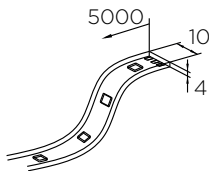

LED

A**... A

91-2492-00-00	3000K-6000K	2420 lm	48W	60 LED/m	 P684
---------------	-------------	---------	-----	----------	---

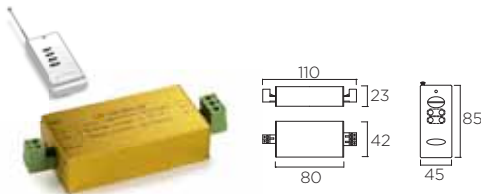

71-3467-00-00

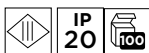
12/24VDC
120/240WControlador / Controller / Contrôleur / Steuergerät /
Regolatori / Controlador / Контроллер / Kontroler

71-3468-00-00

12/24VDC 120/240W

Amplificador / Amplifier / Amplificateur / Verstärker /
Amplificatore / Amplificador / Усилитель / Wzmacniacz

Accesorios / Accessories / Accessoires / Zubehöre / Accessori / Acessórios / Аксессуары / Akcesoria

LINEAL

Perfil de 2m / 2 m profile / Profil de 2 m / 2 M Profil / Profili di 2 m / Calha de 2 m / Профиль 2 м / Profil 2m
ver página / see page / voir page / siehe Seite / vedi pag. / ver página / Смотреть страницу / Zobacz stronę . 206





DEEP

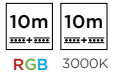
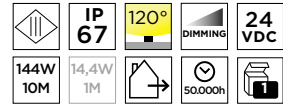
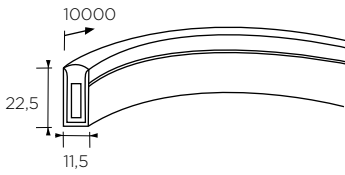

LED

A**... A	91-5452-00-00	3000K	2400 lm	144W	60 LED/m	
	91-5453-00-00	RGB	820 lm			

Accesorios / Accessories / Accessoires / Zubehöre / Accessori / Acessórios / Аксессуары / Akcesoria

71-5320-00-00	Tapón RGB & white / RGB & white Plug / Bouchon RGB et blanc / Deckel Tapón RGB und white / Tappo di chiusura RGB & white / Tampa RGB e white / Zatyczka RGB i white / Заглушка для светодиодной ленты RGB и белой
71-5321-00-00	Conexión white / White connection / Connexion blanc / Anschluss white / Connessione white / Ligação white / Połączenie white / Подсоединение для белого света
71-5322-00-00	Conexión RGB / RGB connection / Connexion RGB / Anschluss RGB / Connessione RGB / Ligação RGB / Połączenie RGB / Подсоединение для RGB
71-5323-00-00	Perfil 3cm 60 uni. / 3cm 60 uni. section / 2m Section / Profil 3 cm 60 unités / 3-cm-Profil 60 St. / Profilo 3cm 60 unità / Perfil 3 cm 60 uni. / Profil 3cm 60 szt. / Профиль 3 см 60 шт.
71-5324-00-00	Perfil 2m. / Profil 2 m / 2-m-Profil / Profilo 2m / Perfil 2 m / Profil 2m / Профиль 2 м



LINEAL



No compatible con tiras DEEP
 Not compatible with DEEP strips
 Non compatible avec les bandeaux DEEP
 Nicht kompatibel mit Bänder DEEP

Non compatibile con strisce DEEP
 Não compatível com tiras DEEP
 Не сочетаемый с лентами DEEP
 Niekompatybilny z taśmami DEEP

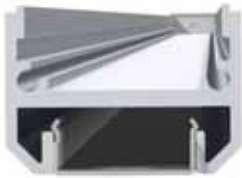

71-3454-54-M2



71-3454-54-M3



71-0289-54-00



71-0566-54-M2



71-0566-54-M3

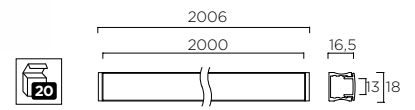
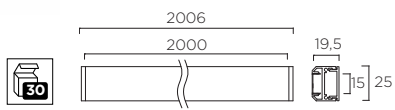

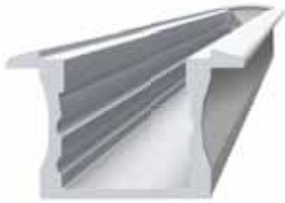

71-0299-54-00

NO
DIFFUSER

71-0580-54-M2

PC
TRÁN
DIF

71-0580-54-M3

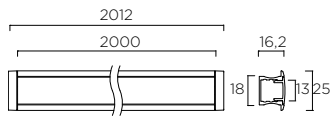
PC
MAT
DIF

71-0331-54-00

NO
DIFFUSER

71-0593-54-M2

PC
TRÁN
DIF

71-0593-54-M3

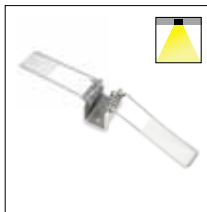
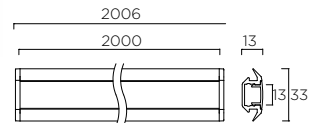
PC
MAT
DIF

71-5455-00-00

Kit para empotrar (2 unidades/ref)
 Recessed kit (2 units/ref)
 Kit d'encastrement (2 unités/réf)
 Einbaukit (2 Stk/Ref)
 Kit per incasso (2 unità/rif)
 Kit para encastrar (2 unidades/ref)
 Набор для встроенного монтажа (2 шт/артикул)
 Zestaw do wbudowania (2 sztuki/ref.)



LINEAL



No compatible con tiras DEEP
 Not compatible with DEEP strips
 Non compatible avec les bandeaux DEEP
 Nicht kompatibel mit Bänder DEEP

Non compatibile con strisce DEEP
 Não compatível com tiras DEEP
 Не сочетаемый с лентами DEEP
 Niekompatybilny z taśmami DEEP



71-0388-54-00 **NO**
DIFFUSER

71-0594-54-M2 **PC**
TRAN
DIF

71-0594-54-M3 **PC**
MAT
DIF

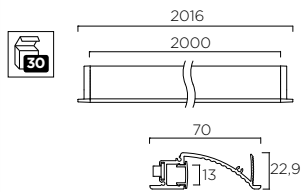

71-1554-54-00

Kit para empotrar en pared de obra / Recessing kit for brick wall / Kit pour encastrer au mur / Einbaukit für Mauerwerk / Kit per incasso a parete / Kit para encastrar em parede de obra / Набор для встроенного монтажа / Zestaw do montażu w ścianach z cegły

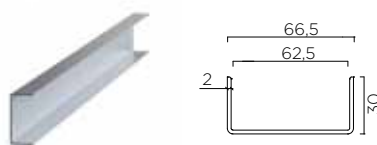



71-5482-14-00
 71-5482-N3-00

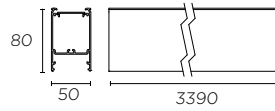

Accesorios / Accessories / Accessoires / Zubehöre / Accessori / Acessórios / Аксессуары / Akcesoria

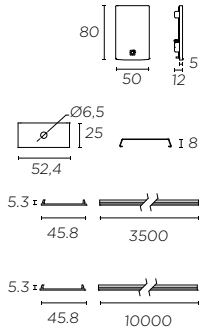

71-5483-14-00 <input type="checkbox"/> 71-5483-N3-00 <input checked="" type="checkbox"/>	Kit 2 tapas / Kit of 2 covers / Kit 2 caches / 2er Set Deckel / Kit 2 tappi / Kit 2 tampas / Zestaw 2 pokryw / Набор 2 заглушки. 2 units
71-5484-00-00	Kit fijación superficie / Surface fixation kit / Kit de fixation en surface / Set zur Wandmontage / Kit fissazione superficie / Kit de fixação à superfície / Zestaw mocujący na powierzchni / Набор для поверхностного крепежа
71-5485-00-00	Difusor PC 3500mm / 3500mm PC diffuser / Diffuseur PC 3500 mm / Diffusor PC 3500 mm / Diffusore PC 3500mm / Difusor PC 3500 mm / Dyfuzor PC 3500mm / Рассеиватель поликарбонатный 3500 мм
71-5486-00-00	Difusor 10000mm / 10000mm Diffuser / Diffuseur 10000 mm / Diffusor 10000 mm / Diffusore 10000mm / Difusor 10000 mm / Dyfuzor 10000mm / Рассеиватель 10000 мм
71-5487-00-00	Fuente alimentación / Power Supply / Source d'alimentation / Stromversorgung / Fonte di alimentazione / Fonte de alimentação / Źródło zasilania - 24VDC / 96W / Источник питания 24 В постоянного тока / 95 Вт
71-4923-00-00	Kit unión perfil / Profile union kit / Kit de raccord profil / Verbindungskit Profil / Kit di unione profilo / Kit de união perfil / Набор соединительный для профиля / Zestaw łączący profil





DECORATIVE

 212-259
FAMILIES

FAMILIAS
FAMILLES
FAMILIEN
FAMIGLIE
FAMILIAS
СЕРИИ
RODZINY

 289-365
**WALL &
CEILING**

PAREDES Y TECHOS
MUR ET PLAFOND
WAND UND DECKE
PARETE E SOFFITTO
PAREDE E TECTO
НАСТЕННЫЕ И ПОТОЛОЧНЫЕ
KINKIETY I SUFITOWE

 398-411
**DESK
& FLOOR**

SOBREMESAS Y PIES
BUREAU ET SOL
TISCH UND STEH
SCRIVANIA E PAVIMENTO
ESCRITÓRIOS E CHÃO
НАСТОЛЬНЫЕ ЛАМПЫ И ТОРШЕРЫ
BIURKOWE I STOJĄCE

 448-493
**CEILING
FANS**

VENTILADORES
VENTILATEURS DE PLAFOND
DECKENVENTILATOREN
VENTILATORI DA SOFFITTO
VENTILADORES DE TECTO
ВЕНТИЛЯТОРЫ
WENTYLATORY SUFITOWE

 260-288
DRESS UP

 366-397
PENDANTS

COLGANTES
SUSPENSIONS
PENDELLEUCHTEN
PENDENTI
PENDENTS
ПОДВЕСНЫЕ СВЕТИЛЬНИКИ
LAMPY WISZĄCE

 412-447
BATH

BAÑO
SALLE DE BAINS
BAD
BAGNO
CASA DE BANHO
ДЛЯ ВАННЫХ КОМНАТ
ŁAZIENKOWE

SEK NEW

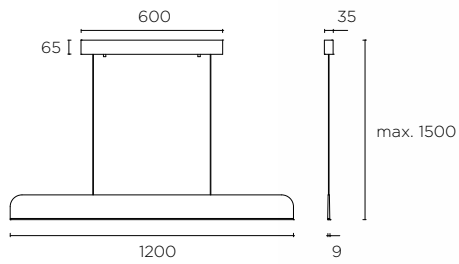

00-5463-53-M3



Led 21W
2700 K | 2400 lm
A**... A



53

	AL ANOD	ACR DIF		IP 20			100-240V 50-60Hz		
--	---------	---------	--	-------	--	--	------------------	--	--

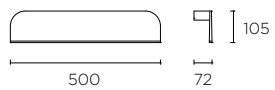

05-5463-53-M3



Led 8W
2700 K | 960 lm
A**... A



53

	AL ANOD	ACR DIF		IP 20				100-240V 50-60Hz		
--	---------	---------	--	-------	--	--	--	------------------	--	--



DECORATIVE | FAMILIES

BRAVO

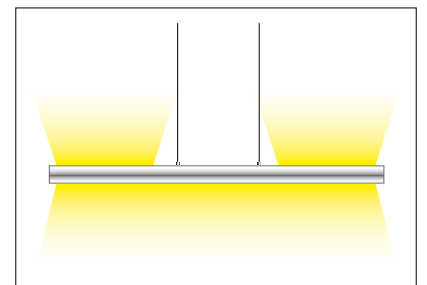
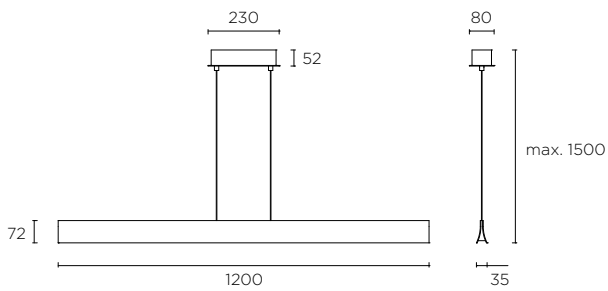

00-4925-F5-M1

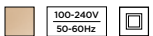

00-4925-34-M1

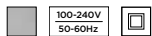

00-4926-F5-M1



00-4926-34-M1



Led **SAMSUNG** 28,3W Down + 11W Up
3000 K | 3056 lm Down + 1200 lm Up
A... A**



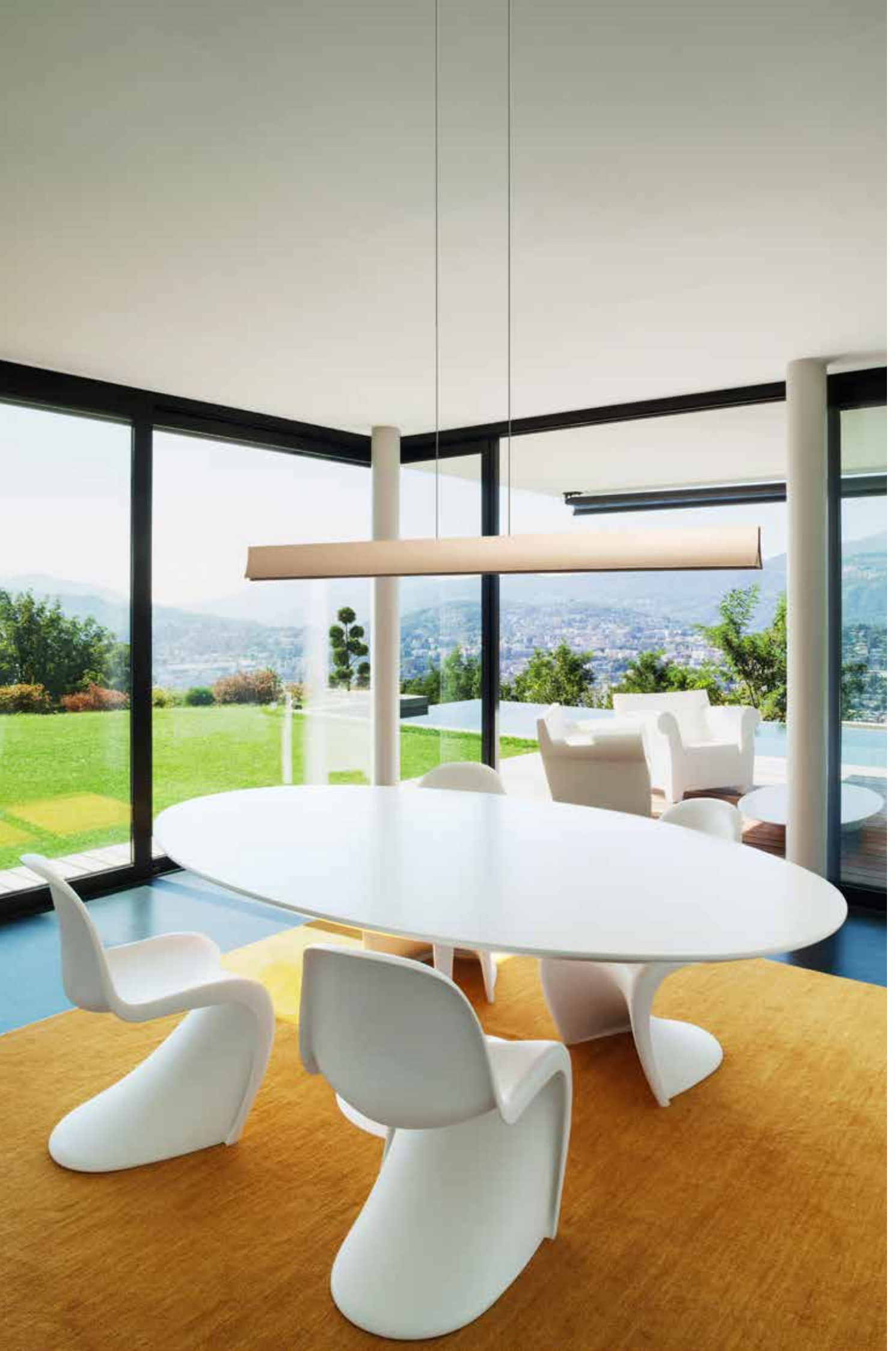

BRAVO

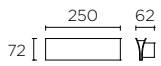

05-4925-F5-M1



05-4925-34-M1



Led **SAMSUNG** 9W Up + 5W Down
3000 K | 1050 lm Up + 315 lm
A... A**

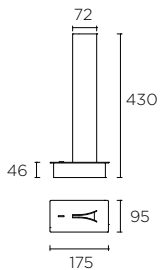
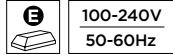
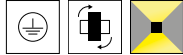
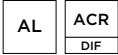
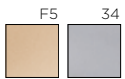

10-4925-F5-M1



10-4925-34-M1



Led **SAMSUNG** 14W
3000 K | 1365 lm
A... A**

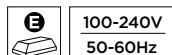
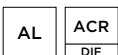



DECORATIVE | FAMILIES

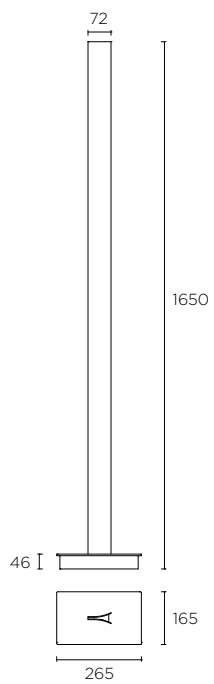

25-4925-F5-M1



25-4925-34-M1



Led **SAMSUNG** 27,3 W
3000 K | 3056 lm
A**... A

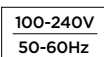

CURL

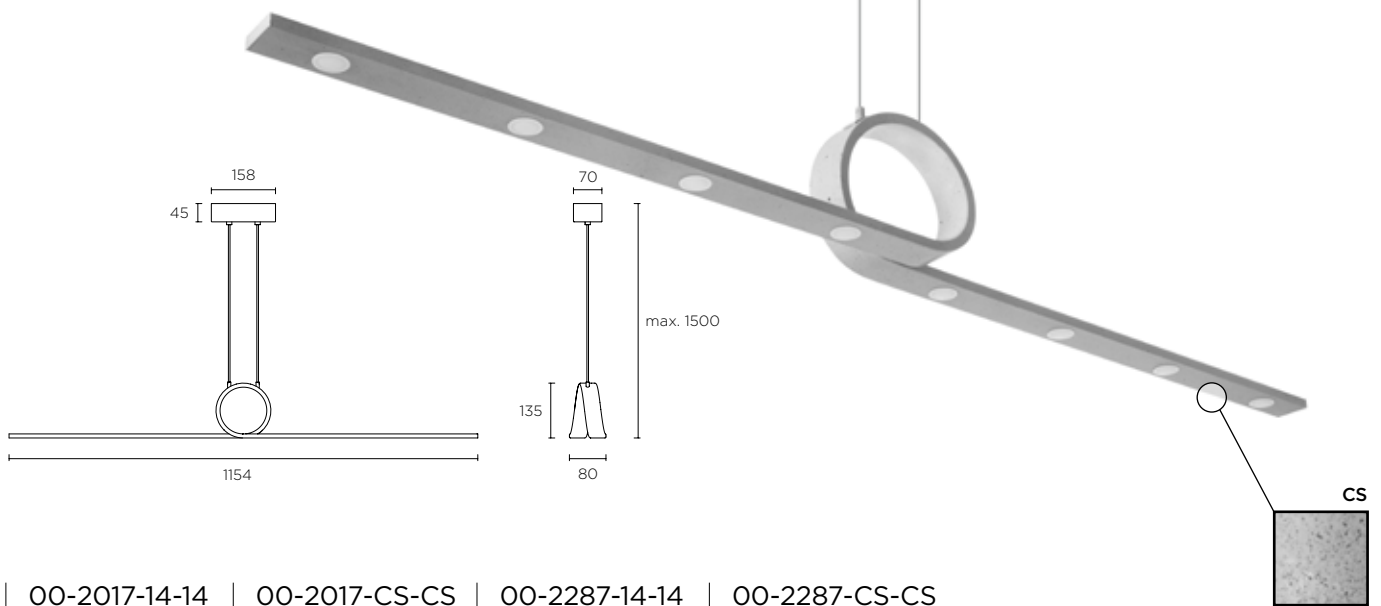

00-2017-14-14

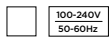

00-2017-CS-CS

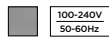

00-2287-14-14



00-2287-CS-CS



Led **CREE** 24W
3000 K | 1296 lm
A... A**

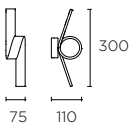
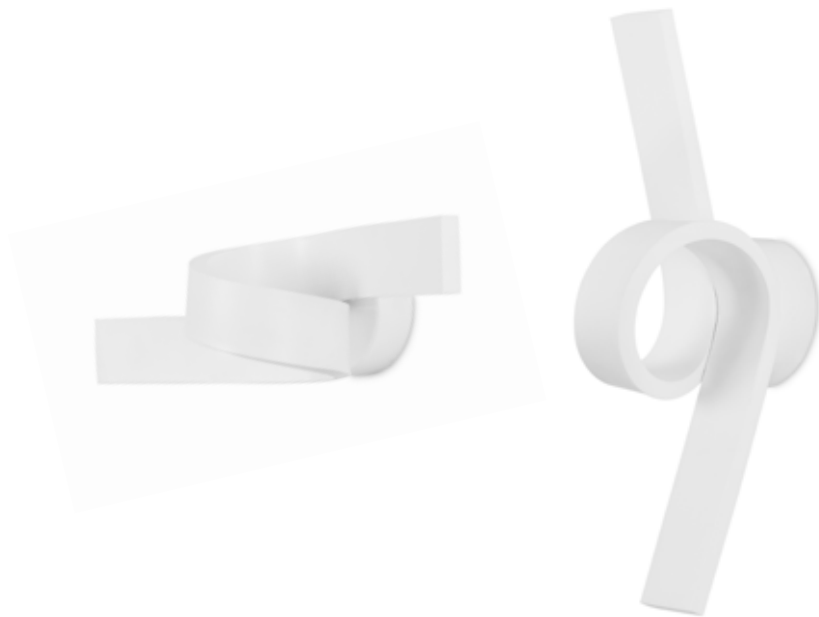
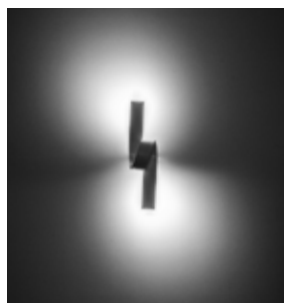
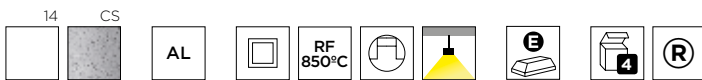

05-2017-14-14

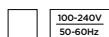

Led **CREE** 6W
3000 K | 324 lm
A... A**

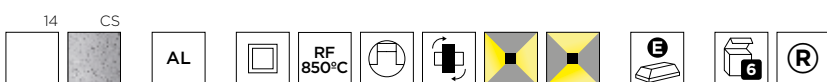



DECORATIVE | FAMILIES

CURL

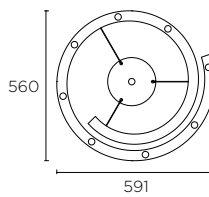
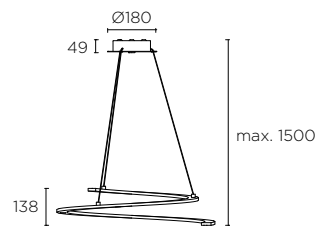

00-4835-14-14

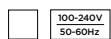

00-4836-14-14



Led **CREE** 24W
3000 K | 1296 lm
A... A**



14

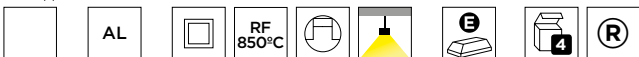



ROAD

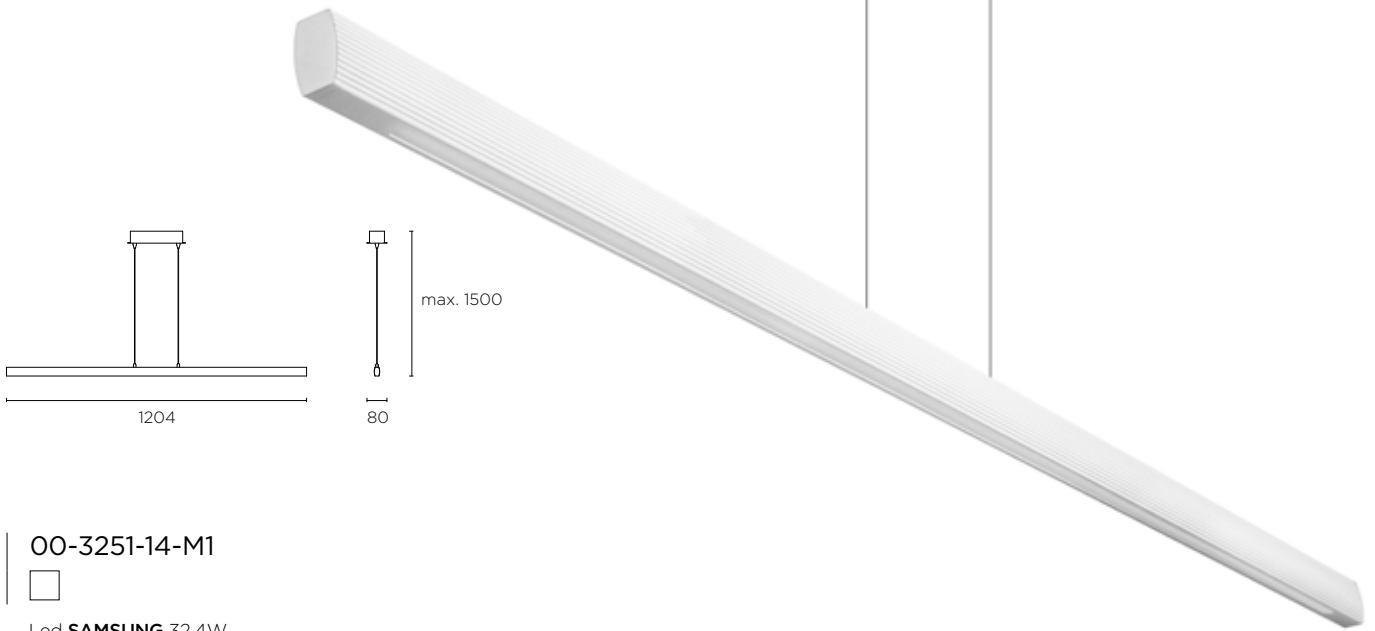

OO-3251-14-M1



Led **SAMSUNG** 32,4W
3000 K | 3860 lm
A... A**

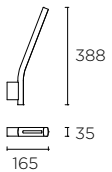
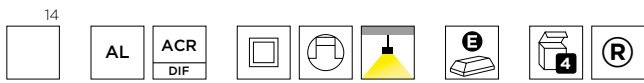

O5-3251-14-M1



Led **SAMSUNG** 6,3W
3000 K | 770 lm
A... A**

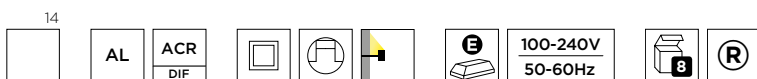



DECORATIVE | FAMILIES

RAW NEW

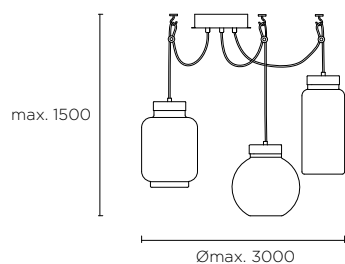

00-5451-CI-E7



Led **CREE** 36W
3000 K | 3480 lm
A**... A

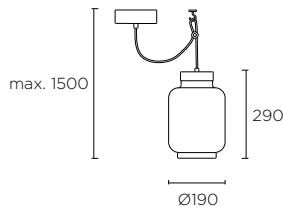
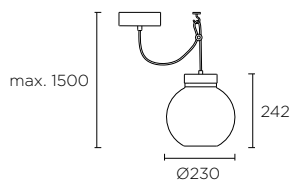
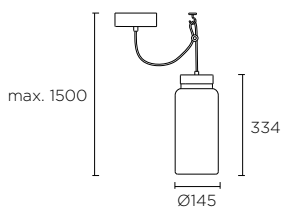

00-5449-CI-15



Led **CREE** 14W
3000 K | 1325 lm
A**... A

00-5450-CI-18



00-5448-CI-08

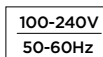

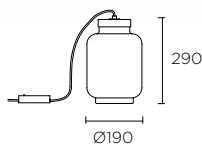
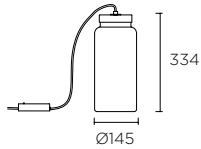
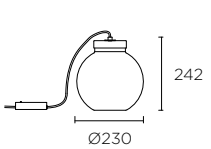

10-5450-CI-18



10-5449-CI-15



10-5448-CI-08



Led **CREE** 7W
3000 K | 550 lm
A**... A



VINTAGE

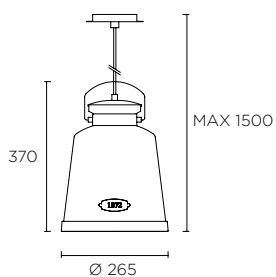

00-0253-S4-CC



00-0253-21-16



E27 max. 100W | max. L 240 mm Ø 220 mm

RECOMMENDED GLOBE 20W

Hal, Fluo, Led

A**... C



P. 77



CC-11 16-25



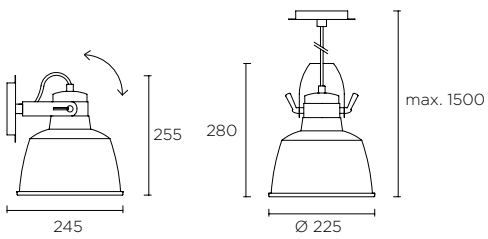

00-0240-21-Z5



00-0240-21-16



E27 max. 100W | max. L 175 mm Ø 85 mm

RECOMMENDED GLOBE 20W

Hal, Fluo, Led

A**... C



P. 77



Z5 - 10 16 - 25



VINTAGE

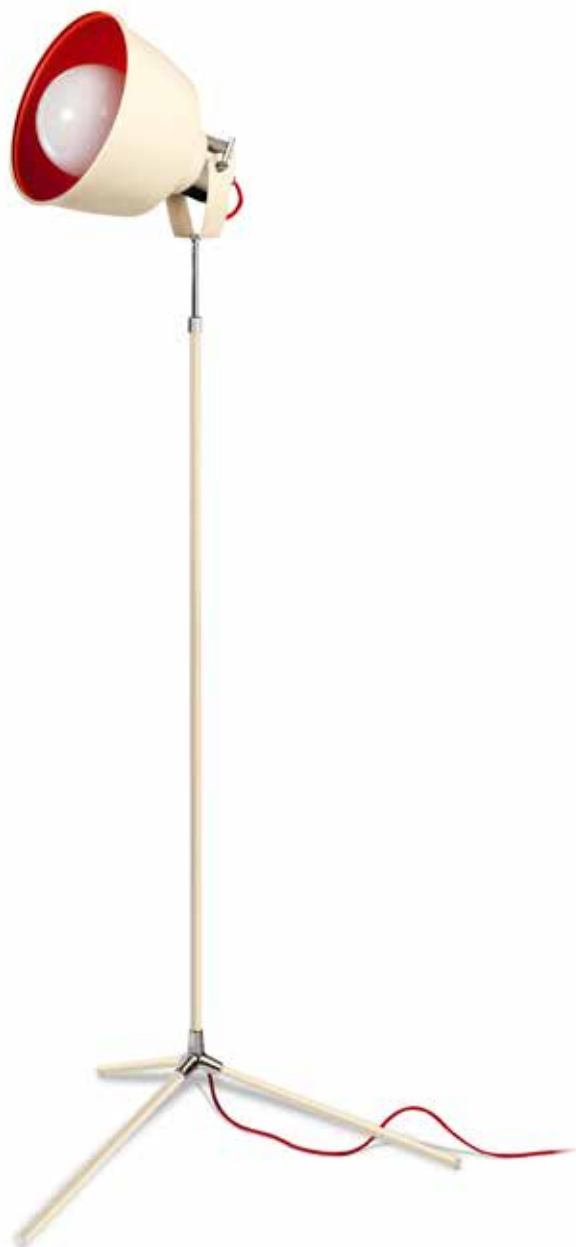

25-0240-21-Z5



25-0240-21-16



E27 max. 100W | max. L 175 mm Ø 85 mm

RECOMMENDED GLOBE 20W

Hal, Fluo, Led

A**... C

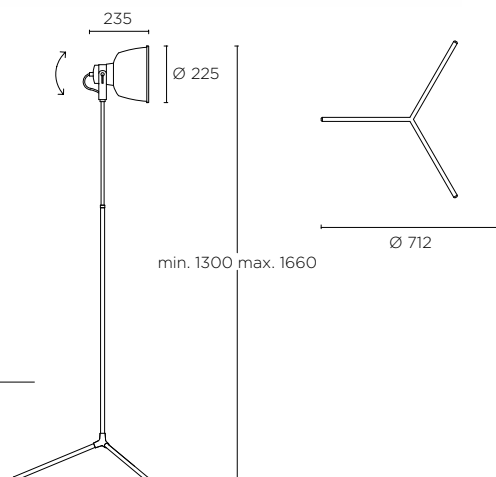

Z5 - 10 16 - 25





DECORATIVE | FAMILIES

FUNK

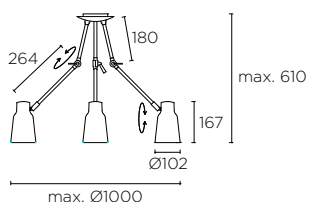

20-4755-CI-23



3xE27 max. 60W | max. L 125 mm Ø 80 mm
Hal, Fluo, Led
A**... C

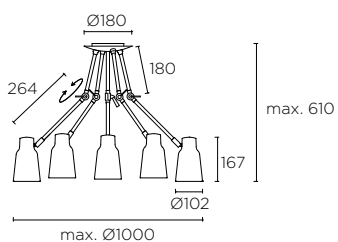

20-4756-CI-23



5xE27 max. 60W | max. L 125 mm Ø 80 mm
Hal, Fluo, Led
A**... C



CI - 23





DECORATIVE | FAMILIES

FUNK

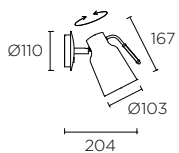

05-4755-CI-23



E27 max. 60W | max. L 125 mm Ø 80 mm
Hal, Fluo, Led
A**... C



Hilo de seda trenzado
Braided silk yarn
Fil en soie tressé
Geflochtener Seidenfaden
Filo di seta intrecciato
Fio de seda entrançado
Переплетенная шелковая нить
Splęciona jedwabna nitka

CI - 23



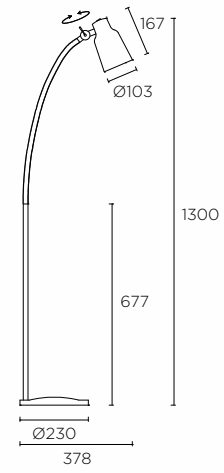

25-4755-CI-23



E27 max. 100W | max. Ø 125 mm L 80 mm
Hal, Fluo, Led
A**... C



DECORATIVE | FAMILIES

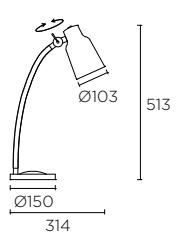

10-4755-CI-23



E27 max. 60W | max. Ø 125 mm L 80 mm
Hal, Fluo, Led
A**... C



CI - 23

STYLUS NEW

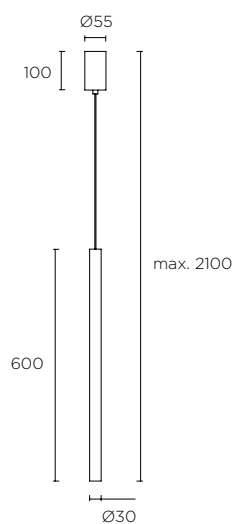

00-5479-05-05



00-5479-14-14



Led **SHARP** 7,5W
3000 K | 730 lm
A**... A

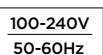



DECORATIVE | FAMILIES

STYLUS

NEW

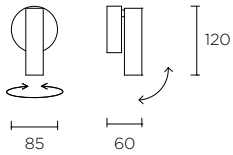

05-5478-14-14



Led **SHARP** 7,5W
3000 K | 730 lm
A... A**

05-5478-05-05

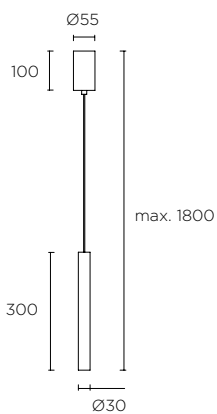

00-5478-14-14



Led **SHARP** 7,5W
3000 K | 730 lm
A... A**

00-5478-05-05



14	05	AL	IP 20	RF 850°C	100-240V 50-60Hz
----	----	----	-------	----------	------------------



00-5480-05-CY



00-5480-05-F5



00-5480-14-CY



00-5480-14-34



Led **SHARP** 7,5W
3000 K | 730 lm
A**... A

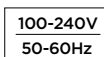
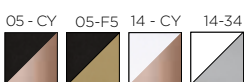
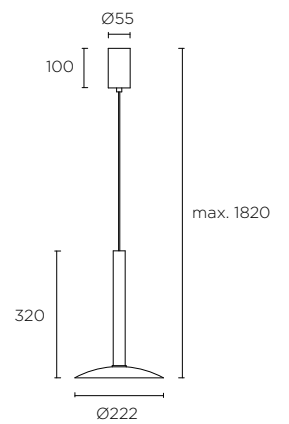

PIPE

NEW



P. 77

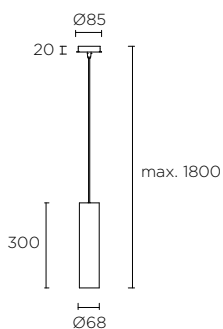

00-5456-14-05



GU10 50W
Hal, Led
A**... C

00-5456-05-23



14 - 05 05 - 23





DECORATIVE | FAMILIES

PIPE



P. 77

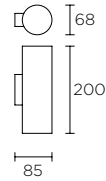
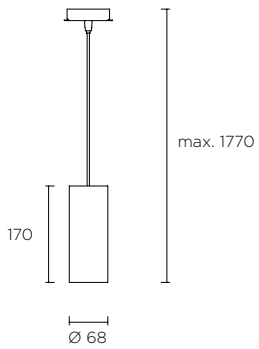

00-0073-14-05



GU10 50W
Hal, Led
A**... C

00-0073-05-23



05-2759-14-05



2xGU10 50W
Hal, Led
A**... C

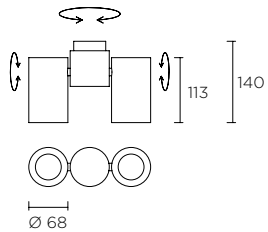

15-0074-14-05



2xGU10 50W
Hal, Led
A**... C

14 - 05 05 - 23





DECORATIVE | FAMILIES

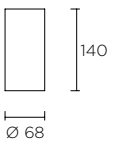

15-0073-14-05



GU10 50W
Hal, Led
A**... C

15-0073-05-23



14 - 05 05 - 23



CUP

NEW

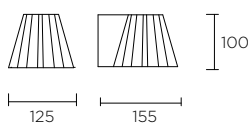
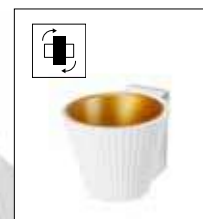
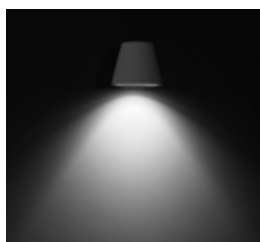

05-5361-14-34



05-5361-14-23



Led **CREE** 7W
2700 K | 550 lm
A**... A

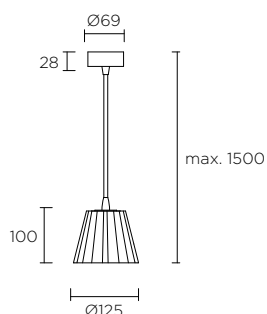

00-5362-14-34



00-5362-14-23



Led **CREE** 7W
2700 K | 550 lm
A**... A



14-34	14-23	ST	PLAS TER		IP 20	RF 850°C		100-240V 50-60Hz	
-------	-------	----	-------------	--	----------	-------------	--	---------------------	--



TRAMA

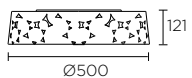

15-4426-14-14



3xE-27 PL Elec. max. 23W | max. L 180 mm Ø 50 mm
Fluo, Led
A**... C

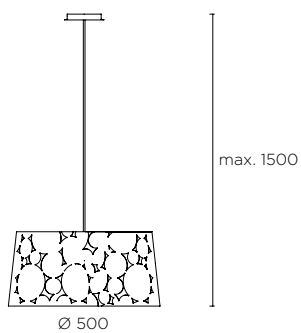

00-4426-14-14



3xE-27 Max. 60W | max. L 155 mm Ø 110 mm
RECOMMENDED GLOBE 20W 
Hal, Fluo, Led
A**... C



P. 77

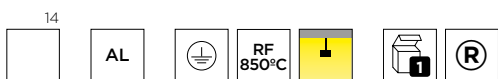



DECORATIVE | FAMILIES

MAGMA

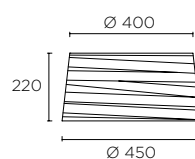

PAN-164-14 L 220 mm Ø 370 mm
PAN-164-05 L 220 mm Ø 370 mm

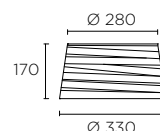

PAN-163-14 L 170 mm Ø 250 mm
PAN-163-05 L 170 mm Ø 250 mm

00-0268-21-82 + 2xPAN



2xE27 max. 100W

RECOMMENDED GLOBE 20W

Hal, Fluo, Led

A**... C

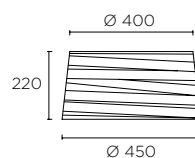
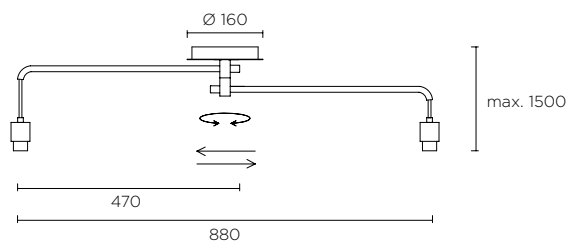

PAN-164-14 L 220 mm Ø 370 mm
PAN-164-05 L 220 mm Ø 370 mm

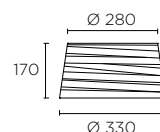

PAN-163-14 L 170 mm Ø 250 mm
PAN-163-05 L 170 mm Ø 250 mm

00-0264-21-82 + PAN



E27 max. 100W

RECOMMENDED GLOBE 20W

Hal, Fluo, Led

A**... C

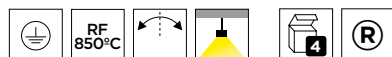
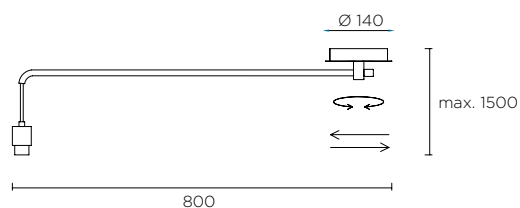



MAGMA

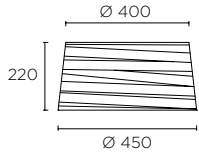
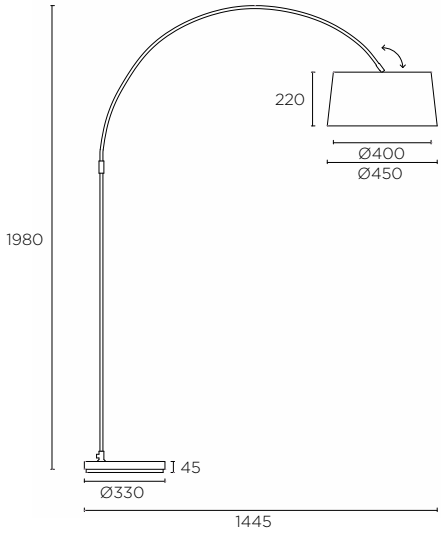

25-0467-21-82 + PAN



E27 max. 100W
RECOMMENDED GLOBE 20W
 Hal, Fluo, Led
A... C**

PAN-164-14 L 220 mm Ø 370 mm
PAN-164-05 L 220 mm Ø 370 mm

21 PAN 14 PAN 05





VIRGINIA

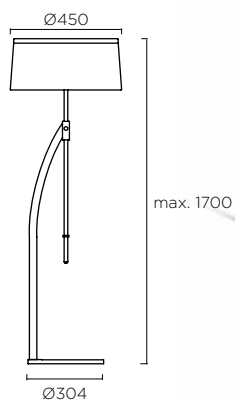
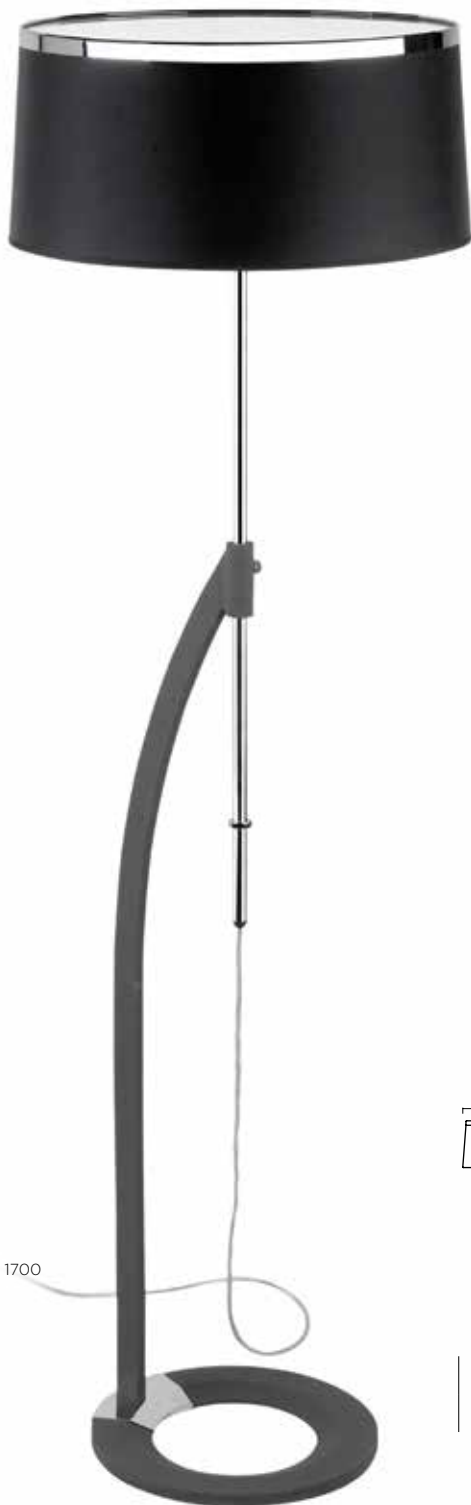

25-4339-21-05



3xE27 max. 16W | max. L 150 mm Ø 70 mm
Fluo, Led
A**... C

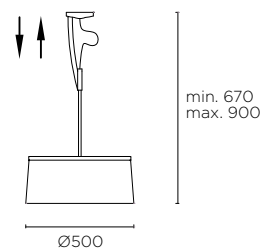

00-4339-21-05



3xE27 pl elec. max. 21W | max. L 160 mm Ø 90 mm
Fluo, Led
A**... C

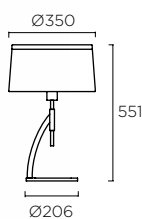

10-4339-21-05



E27 pl elec. max. 16W | max. L 170 mm Ø 290 mm
Fluo, Led
A**... C



21 - Z5 PAN 05

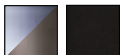



DECORATIVE | FAMILIES

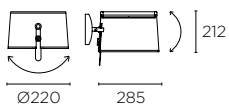

05-4339-21-05



E27 pl elec. max. 16W | max. L 140 mm Ø 90 mm
Fluo, Led
A**... C



TWIST

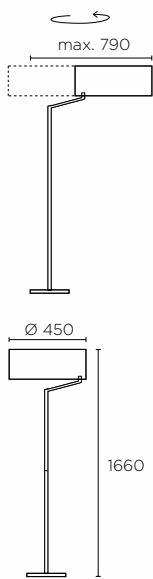
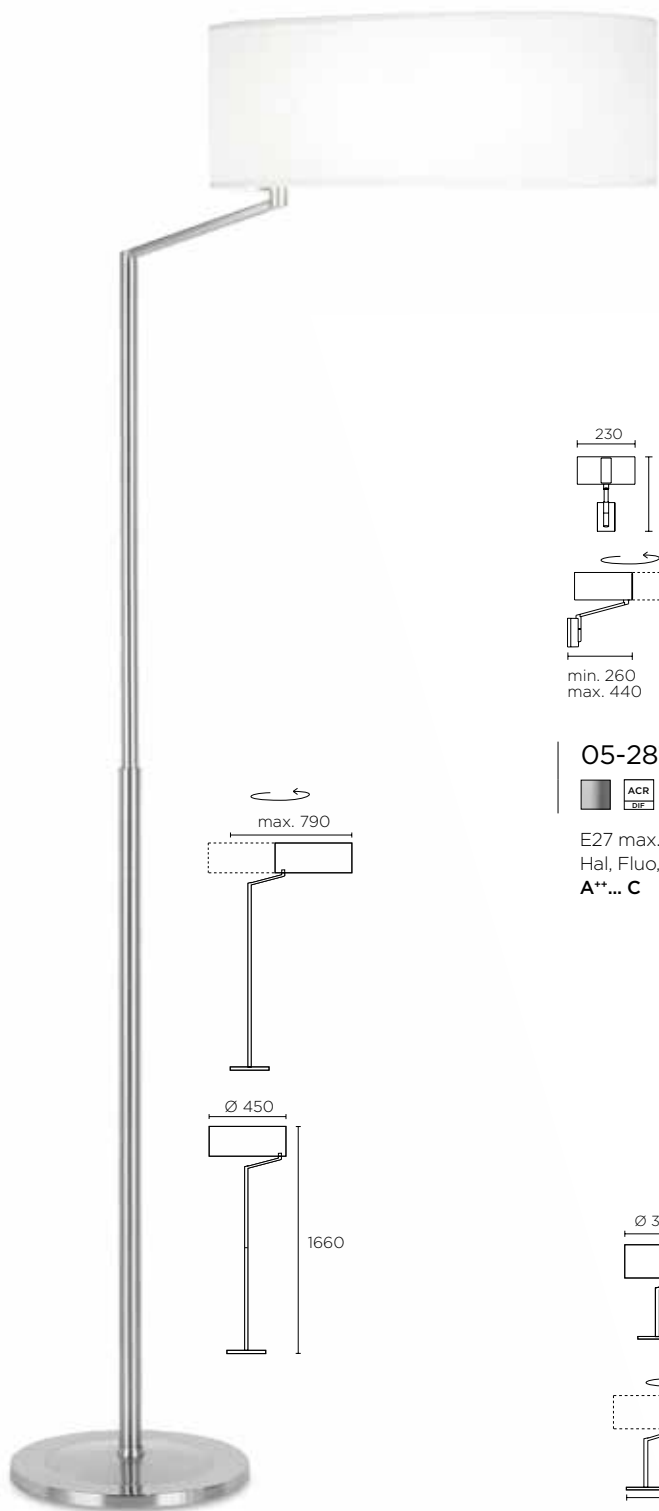

25-2817-81-14



E27 max. 150W | max. L 250 mm Ø 130 mm
Hal, Fluo, Led
A**... C

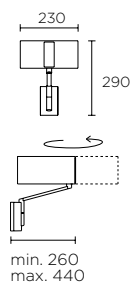

05-2817-81-14



E27 max. 60W esf. Ø45 | max. L 130 mm Ø 70 mm
Hal, Fluo, Led
A**... C

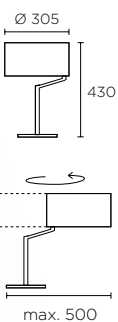

10-2817-81-14



E27 max. 60W esf. Ø45 | max. L 160 mm Ø 70 mm
Hal, Fluo, Led
A**... C



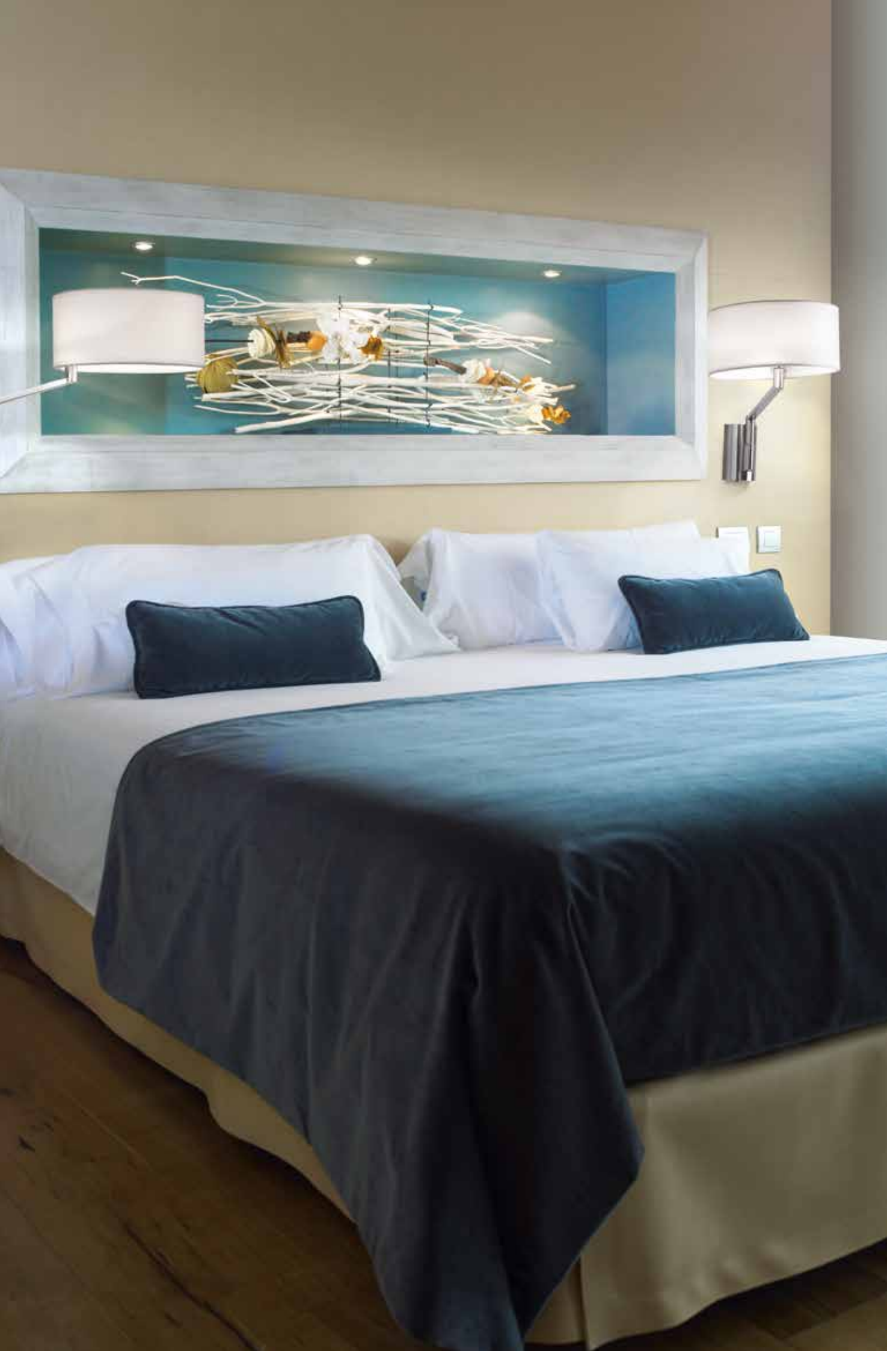

DECORATIVE | FAMILIES

FANCY

NEW

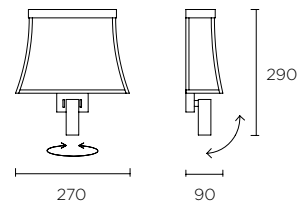
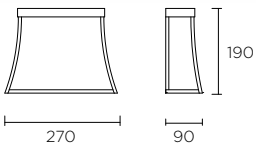

05-5425-CI-20



Led **SAMSUNG** 6,2W
2700 K | 800 lm
A**... A

05-5427-CI-20



Led **SAMSUNG** 6,2W
2700 K | 800 lm
Led **CREE** 2,2W
2700 K | 162 lm
A**... A

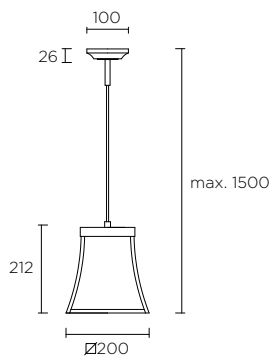

00-5425-CI-20



Led **CREE** 12,2W
2700 K | 1300 lm
A**... A





FANCY NEW

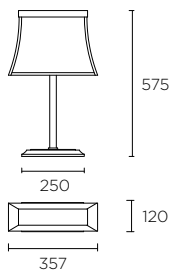

10-5425-CI-20



Led **SAMSUNG** 12,4W
2700 K | 1600 lm
A**... A

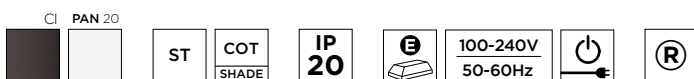

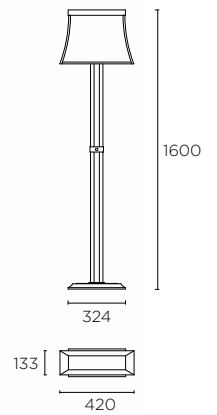

25-5425-CI-20



Led **SAMSUNG** 6,2W Up + 16,2 Down
2700 K | 800 lm Up + 2150 lm Down
A... A**



DECORATIVE | FAMILIES

ALSACIA

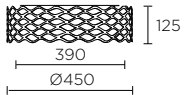

15-4341-Z6-20



3xE27 max. 40W | max. L 170 mm Ø 60 mm
Hal, Fluo, Led
A**... C

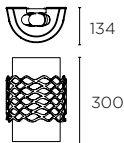
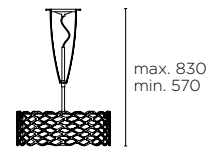
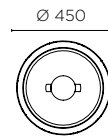

05-4341-Z6-20



2xE27 pl elec. max. 23W | max. L 170 mm Ø 60 mm
Fluo, Led
A**... C

00-4341-Z6-20



3xE27 max. 60W | max. L 120 mm Ø 100 mm
Hal, Fluo, Led
A**... C

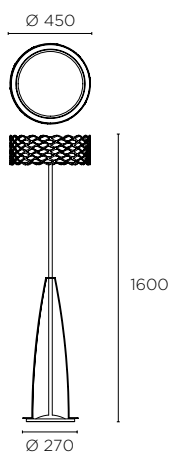
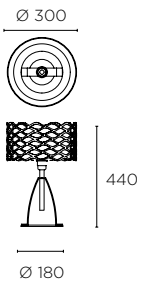

10-4341-Z6-20



E27 max. 100W | max. L 150 mm Ø 220 mm
RECOMMENDED GLOBE 20W 
Hal, Fluo, Led
A**... C

25-4341-Z6-20



3xE27 max. 60W | max. L 120 mm Ø 220 mm
Hal, Fluo, Led
A**... C



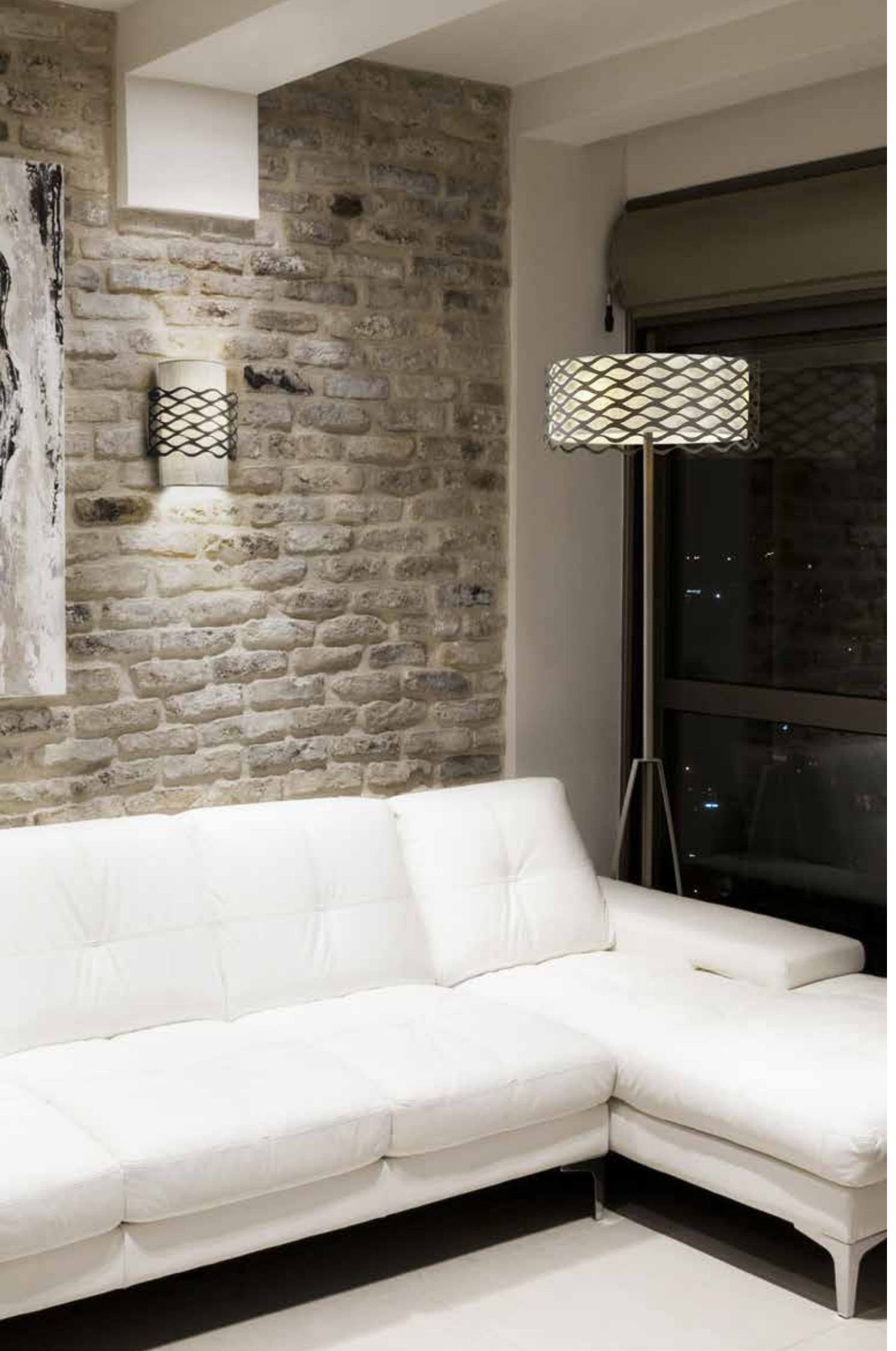

DECORATIVE | FAMILIES



DRESS UP!

VISTE LA ESTRUCTURA A TU GUSTO. COMPLETE THE STRUCTURE WITH THE SHADE YOU LIKE. HABILLEZ LA STRUCTURE À VOTRE GOÛT. STELLEN SIE DIE STRUKTUR NACH IHREM GESCHMACK EIN. STRUTTURA IL TUO STILE. VESTE A ESTRUTURA A TEU GOSTO. ВЫБЕРИТЕ СТРУКТУРУ И АБАЖУР, СОЗДАЙТЕ СВОЮ ЛАМПУ. SAM DOBIERZ ABAZUR DO WYBRANEJ LAMPY.



XS	S	S	M	L	XL
 PAN-175-14	 PAN-177-14	 PAN-157-14	 PAN-161-14	 PAN-184-14	 PAN-159-14
 PAN-175-BY	 PAN-177-BY	 PAN-157-BY	 PAN-161-BY	 PAN-184-BY	 PAN-159-BY



S	S	XS	S	M	L
 PAN-219-14	 PAN-194-AJ	 PAN-198-V7	 PAN-199-V7	 PAN-220-V7	 PAN-221-V7
 PAN-219-05					

HOW TO USE ?

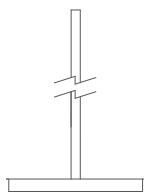
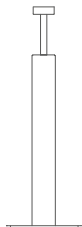
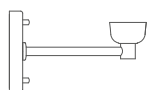

1. Step

Elige la estructura en el acabado que más te guste.
Choose the structure in the finish that best suits you.
Choisissez la structure dans la finition de votre goût.
Bitte wählen Sie die gewünschte Struktur.
Scegli la struttura nella rifinitura di tuo gusto.
Escolha a estrutura no acabamento ao seu gosto.
Выберите структуру в желаемой отделке.
Wybierz podstawę w kolorze, który najbardziej pasuje.

2. Step

Elige la forma, tamaño y acabado de la pantalla.
Select the shape, size and finish of the shade.
Sélectionnez le modèle, la dimension et la finition de l'abat-jour.
Bitte wählen Sie und Struktur, Größe und Farbe des Lampenschirmes.
Scegli la forma, la dimensione e la rifinitura del paralume.
Escolha a forma, o tamanho e o acabamento do abat-jour.
Выберите форму, размер и отделку абажура.
wybierz kształt, wielkość i wykończenie abażura.

3. Step

¡Tu lámpara está lista!
Your lamp is now ready!
Votre luminaire est prêt !
Die Lampe ist fertig!
La tua lampada è pronta!
A sua luminária está pronta.
Ваша лампа готова!
Lampa jest gotowa.

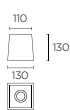

XS



PAN-178-14



PAN-178-BY

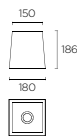

S



PAN-179-14



PAN-179-BY

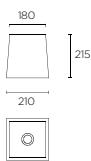

M



PAN-180-14



PAN-180-BY

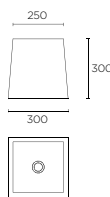

L



PAN-181-14



PAN-181-BY



S



PAN-176-14



PAN-176-BY

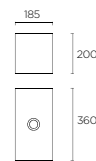

M



PAN-182-14



PAN-182-BY

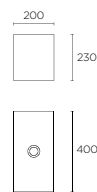

L



PAN-183-14



PAN-183-BY



PAN-182-T001













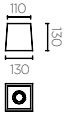

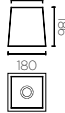





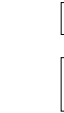

DRESS
UP!

	XS	S	S	M	L	XL	S
	PAN-175-14 max. L 125 mm Ø 110 mm	PAN-177-14 max. L 140 mm Ø 120 mm	PAN-157-14 max. L 140 mm Ø 135 mm	PAN-161-14 max. L 190 mm Ø 185 mm	PAN-184-14 max. L 190 mm Ø 240 mm	PAN-159-14 max. L 245 mm Ø 290 mm	
	PAN-175-BY max. L 125 mm Ø 110 mm	PAN-177-BY max. L 140 mm Ø 120 mm	PAN-157-BY max. L 140 mm Ø 135 mm	PAN-161-BY max. L 190 mm Ø 185 mm	PAN-184-BY max. L 190 mm Ø 240 mm	PAN-159-BY max. L 245 mm Ø 290 mm	
							PAN-219-14 max. L 140 mm Ø 135 mm
							PAN-219-05 max. L 140 mm Ø 135 mm

COLLECTIONS CODE

BALI	05-3217-XX-82	●	●	●			●
	05-3218-XX-82	●	●	●			●
BRISTOL	05-2815-81-81	●	●	●			●
	05-2820-XX-XX	●	●	●			●
	10-4759-81-82		●	●	●		●
	25-4759-81-82					●	●
DELUXE	05-4919-21-82		●	●			●
	05-4920-21-82		●	●			●
	10-4919-21-82		●	●	●	●	
	25-4919-21-82					●	
DEVON	10-2825-81-82				●	●	
	25-2825-21-82					●	●
DOVER	170-NS	●	●	●			●
	172-NS	●	●	●			●
	174-NS		●	●	●		●
	176-NS					●	
GLOSS	05-2755-81-21	●	●	●			●
	05-2756-81-21	●	●	●			●
LYON	05-1567-81-82	●	●				
	10-1567-81-82		●	●	●		●
	25-1567-81-82					●	●
MICHIGAN	05-2757-14-82	●	●	●			●
	05-2758-14-82	●	●	●			●
	10-2757-14-82		●	●	●		●
	25-2757-14-82					●	
MILAN	10-1568-81-82			●	●		●
	25-1568-81-82				●	●	
OXFORD	05-2840-21-82			●	●		●
SPICA	20-2012-Z6-82	●		●			●
	20-2013-Z6-82	●		●			●
	05-2510-Z6-82	●	●	●			●
	10-4369-Z6-82		●		●	●	●
	20-2510-Z6-82	●		●	●		●
	25-2510-Z6-82					●	●
TORINO	05-4695-XX-82	●	●	●	●		●
	05-4696-XX-82	●	●	●	●		●
	10-4695-XX-82		●	●	●		●
	25-4695-XX-82					●	







	XS	S	M	L	S	M	L
	  	  	  	  	  	  	  
	PAN-178-14 max. L 135 mm Ø 80 mm	PAN-179-14 max. L 175 mm Ø 120 mm	PAN-180-14 max. L 205 mm Ø 150 mm	PAN-181-14 max. L 280 mm Ø 220 mm	PAN-176-14 max. L 160 mm Ø 120 mm	PAN-182-14 max. L 190 mm Ø 155 mm	PAN-183-14 max. L 220 mm Ø 170 mm
	PAN-178-BY max. L 135 mm Ø 80 mm	PAN-179-BY max. L 175 mm Ø 120 mm	PAN-180-BY max. L 205 mm Ø 150 mm	PAN-181-BY max. L 280 mm Ø 220 mm	PAN-176-BY max. L 160 mm Ø 120 mm	PAN-182-BY max. L 190 mm Ø 155 mm	PAN-183-BY max. L 220 mm Ø 170 mm
						PAN-182-T001 max. L 190 mm Ø 155 mm	

COLLECTIONS CODE

BALI	05-3217-XX-82	●				●		
	05-3218-XX-82	●				●		
BRISTOL	05-2815-81-81	●	●			●		
	05-2820-XX-XX	●	●			●		
	10-4759-81-82		●	●		●		
	25-4759-81-82				●		●	
DELUXE	05-4919-21-82	●	●	●		●		
	05-4920-21-82	●	●	●		●		
	10-4919-21-82			●	●	●	●	
	25-4919-21-82				●		●	●
DEVON	10-2825-81-82			●	●		●	
	25-2825-21-82				●		●	●
DOVER	170-NS	●	●			●		
	172-NS	●				●		
	174-NS		●	●		●		
	176-NS				●		●	●
GLOSS	05-2755-81-21	●	●			●		
	05-2756-81-21	●	●			●		
LYON	05-1567-81-82	●	●			●		
	10-1567-81-82		●	●	●	●	●	
	25-1567-81-82				●		●	●
MICHIGAN	05-2757-14-82	●	●			●		
	05-2758-14-82	●	●			●		
	10-2757-14-82		●	●		●		
	25-2757-14-82				●		●	●
MILAN	10-1568-81-82		●	●				
	25-1568-81-82			●	●		●	
OXFORD	05-2840-21-82	●	●			●		
SPICA	20-2012-Z6-82	●	●					
	20-2013-Z6-82	●	●					
	05-2510-Z6-82	●				●		
	10-4369-Z6-82			●		●		
	20-2510-Z6-82	●	●	●				
	25-2510-Z6-82			●	●		●	●
TORINO	05-4695-XX-82	●	●			●		
	05-4696-XX-82	●	●			●		
	10-4695-XX-82		●	●		●		
	25-4695-XX-82				●		●	●

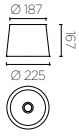

DRESS
UP!

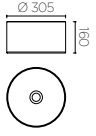
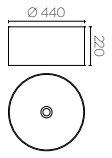
	S	XS	S	M	L
					
					
	PAN-194-AJ max. L 160 mm Ø 155 mm				
		PAN-198-V7 max. L 125 mm Ø 155 mm	PAN-199-V7 max. L 130 mm Ø 205 mm	PAN-220-V7 max. L 165 mm Ø 275 mm	PAN-221-V7 max. L 150 mm Ø 410 mm

COLLECTIONS CODE

BALI	05-3217-XX-82		•			
	05-3218-XX-82		•			
BRISTOL	05-2815-81-81		•			
	05-2820-XX-XX		•			
	10-4759-81-82	•	•	•		
	25-4759-81-82				•	•
DELUXE	05-4919-21-82	•	•			
	05-4920-21-82	•	•			
	10-4919-21-82				•	
	25-4919-21-82				•	•
DEVON	10-2825-81-82				•	•
	25-2825-21-82				•	•
DOVER	170-NS	•	•	•		
	172-NS	•	•	•		
	174-NS	•	•	•		
	176-NS				•	
GLOSS	05-2755-81-21	•	•			
	05-2756-81-21	•	•			
LYON	05-1567-81-82					
	10-1567-81-82	•	•	•		
	25-1567-81-82				•	•
MICHIGAN	05-2757-14-82	•	•	•		
	05-2758-14-82	•	•	•		
	10-2757-14-82	•	•	•		
	25-2757-14-82				•	
MILAN	10-1568-81-82	•	•	•		
	25-1568-81-82				•	•
OXFORD	05-2840-21-82	•		•		
SPICA	20-2012-Z6-82		•			
	20-2013-Z6-82			•		
	05-2510-Z6-82		•			
	10-4369-Z6-82				•	
	20-2510-Z6-82			•		
	25-2510-Z6-82					•
TORINO	05-4695-XX-82	•	•	•		
	05-4696-XX-82	•	•	•		
	10-4695-XX-82	•	•	•		
	25-4695-XX-82				•	



SPICA

05-2510-Z6-82 + PAN-157-BY

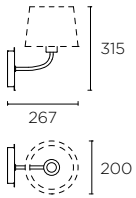

05-2510-Z6-82 + PAN



E27 max 60W
Hal, Fluo, Led

RECOMMENDED MINI CANDLE 9W 

A**... C

20-2510-Z6-82 + PAN-199-V7



10-4369-Z6-82 + PAN-177-BY

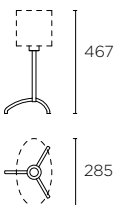

10-4369-Z6-82 + PAN



E27 max. 100W
Hal, Fluo, Led

A**... C

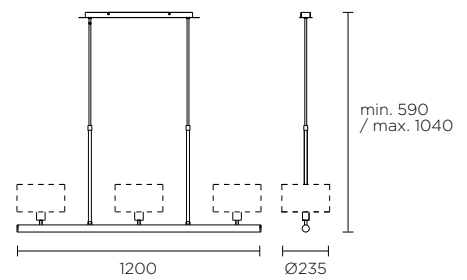

20-2510-Z6-82 + PAN



3xE27 max. 60W
Hal, Fluo, Led

RECOMMENDED MINI CANDLE 9W 

A**... C

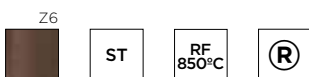

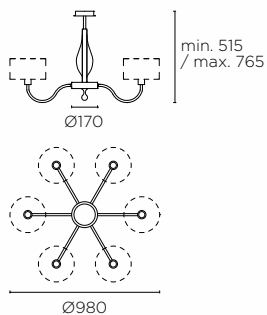

20-2013-Z6-82 + PAN



6xE27 max. 60W
Hal, Fluo, Led
RECOMMENDED MINI CANDLE 9W

A**... C



20-2013-Z6-82 + PAN-199-V7



20-2012-Z6-82 + PAN-157-BY

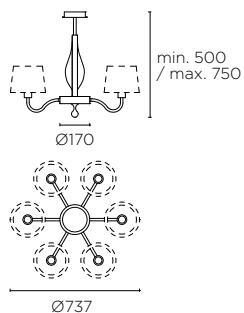

20-2012-Z6-82 + PAN



6xE27 max. 60W
Hal, Fluo, Led
RECOMMENDED MINI CANDLE 9W

A**... C

25-2510-Z6-82 + PAN-159-14

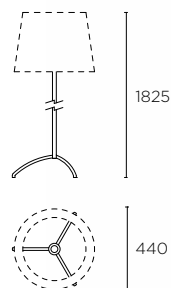

25-2510-Z6-82 + PAN



E27 max. 100W
Hal, Fluo, Led
A**... C



P. 262-264



DECORATIVE | DRESS UP

Z6

GLOSS



05-2756-81-21 + PAN-219-14

05-2756-81-21 + PAN



E27 max. 60W
Hal, Fluo, Led
Led **CREE** 1W
3000K | 94 lm
A... C A**... A**

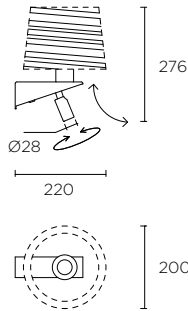

81 - 21

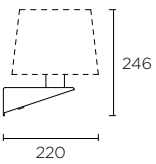
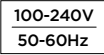

05-2755-81-21 + PAN



E27 max. 60W
Hal, Fluo, Led
A... C**



05-2755-81-21 + PAN-157-BY



P. 262-264

81 - 21



BRISTOL



DECORATIVE | DRESS UP



25-4759-81-82
+ PAN-159-14

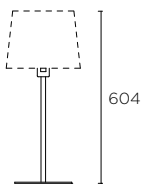

10-4759-81-82 + PAN



E27 max. 60W
Hal, Fluo, Led
A**... C

10-4759-81-82 + PAN-161-BY

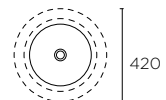
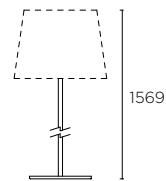

25-4759-81-82 + PAN



E27 max. 100W
Hal, Fluo, Led
A**... C



P. 262-264



BRISTOL

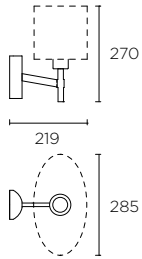

05-2815-81-81 + PAN



E27 max. 60W
Hal, Fluo, Led
A**... C



05-2815-81-81 + PAN-177-BY

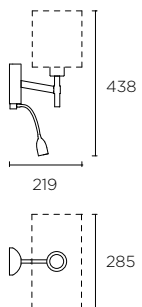

05-2820-81-81 + PAN



E27 max. 60W
Hal, Fluo, Led
Led **CREE** 2,2W
3000K | 162 lm
A**... C A**... A

05-2820-21-21 + PAN



05-2820-21-21 + PAN-176-14

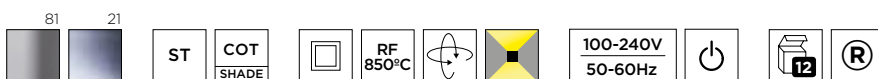

P. 262-264



DECORATIVE | DRESS UP

BALI

05-3217-XX-82
+ PAN-157-XX

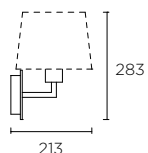

05-3217-19-82 + PAN



05-3217-81-82 + PAN



05-3217-21-82 + PAN



05-3217-E4-82 + PAN



E27 max. 60W
Hal, Fluo, Led
A**... C

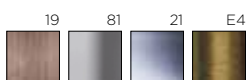

05-3218-XX-82
+ PAN-157-XX

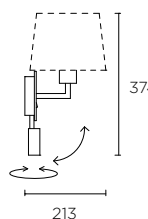

05-3218-19-82 + PAN



05-3218-81-82 + PAN



05-3218-21-82 + PAN



05-3218-E4-82 + PAN



E27 max. 60W
Hal, Fluo, Led
Led **CREE** 2,1W
3000K | 162 lm
A**... C A**... A



P. 262-264



TORINO

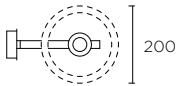
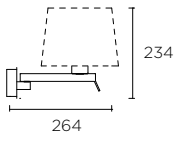

05-4696-Y2-82 + PAN-157-14



05-4696-81-82 + PAN



05-4696-Y2-82 + PAN



E27 max. 60W
Hal, Fluo, Led
A**... C

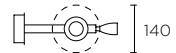
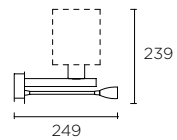
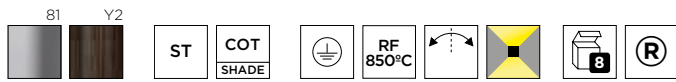

05-4695-81-82 + PAN-175-BY



05-4695-Y2-82 + PAN



05-4695-81-82 + PAN



E27 max. 60W
Hal, Fluo, Led
Led **CREE** 3W
3000K | 162 lm
A**... C A**... A

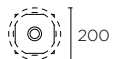
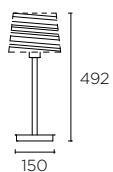

10-4695-21-82 + PAN-219-05



10-4695-81-82 + PAN



10-4695-21-82 + PAN



E27 max. 60W
Hal, Fluo, Led
A**... C





25-4695-81-82 + PAN-159-BY

25-4695-21-82 + PAN-159-14



DECORATIVE | DRESS UP



P. 262-264

25-4695-81-82 + PAN



E27 max. 100W
Hal, Fluo, Led
A**... C

25-4695-21-82 + PAN

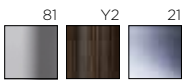

DOVER

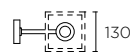
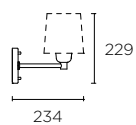

172-NS + PAN



E27 max. 60W
Hal, Fluo, Led
A**... C



172-NS + PAN-178-BY

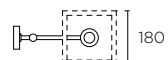
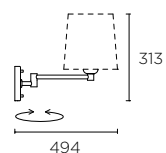

170-NS + PAN



E27 max. 60W
Hal, Fluo, Led
A**... C



170-NS + PAN-179-14

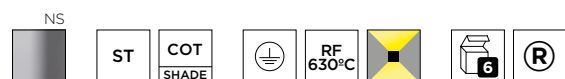



176-NS + PAN-184-14

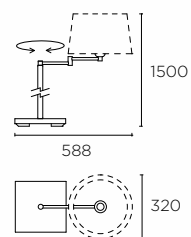
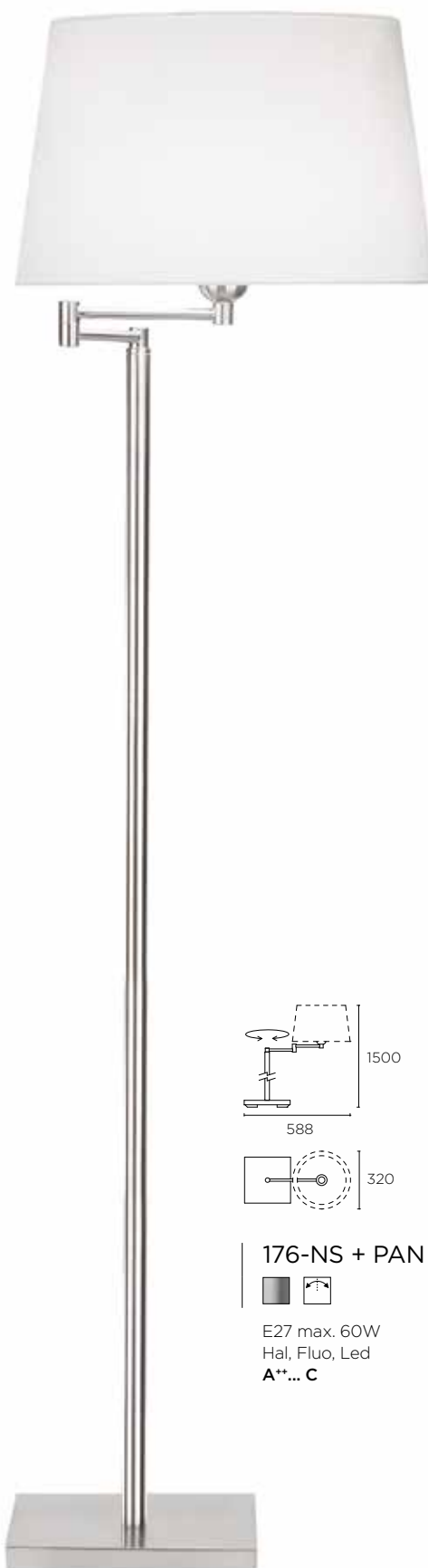

176-NS + PAN



E27 max. 60W
Hal, Fluo, Led
A**... C



174-NS + PAN-157-14

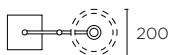
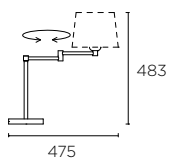

174-NS + PAN



E27 max. 60W
Hal, Fluo, Led
A**... C

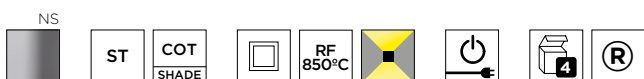

DELUXE

05-4919-21-82 + PAN-219-05

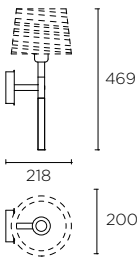

05-4919-21-82 + PAN



E27 max. 60W
Hal, Fluo, Led
A**... C

21-05



ST



RF
850°C

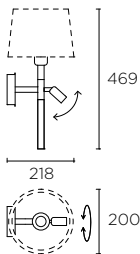

05-4920-21-82 + PAN



E27 max. 60W
Led **CREE** 2,2W
3000K | 162 Lm
Hal, Fluo, Led
A**... C A**... A

21-05



ST



RF
850°C



100-240V
50-60Hz



05-4920-21-82 + PAN-157-14





Polipiel (piel sintética)
 Synthetic leather
 Similicuir
 Kunstleder
 Pelle sintética
 Pele sintética
 Искусственная кожа
 Skaj



DECORATIVE | DRESS UP

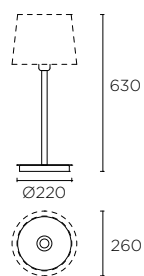
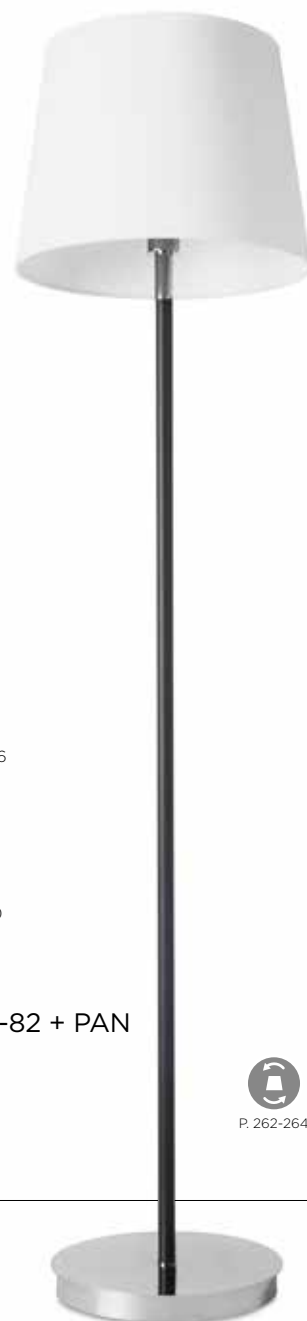

10-4919-21-82 + PAN



E27 max. 60W
 Hal, Fluo, Led
 A**... C

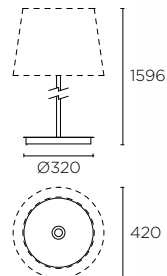

25-4919-21-82 + PAN



E27 max. 60W
 Hal, Fluo, Led
 A**... C



P. 262-264

21 - 05



DEVON

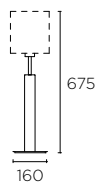

10-2825-21-82 + PAN



E27 max. 60W
Hal, Fluo, Led
A**... C

10-2825-21-82 + PAN-182-14

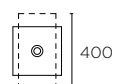
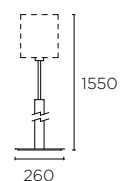

25-2825-21-82 + PAN



E27 max. 100W
Hal, Fluo, Led
A**... C

25-2825-21-82 + PAN-183-BY



P. 262-264

21





DECORATIVE | DRESS UP

MICHIGAN

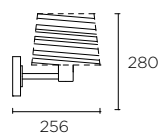

05-2757-14-82 + PAN



E27 max. 60W
Hal, Fluo, Led
A**... C

05-2757-14-82 + PAN-219-14

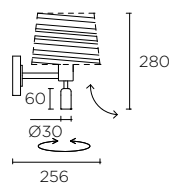
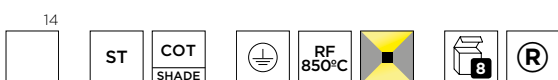

05-2758-14-82 + PAN



E27 max. 60W
Hal, Fluo, Led
Led 1W
3000K | 94 lm
A**... C A**... A

05-2758-14-82 + PAN-219-14

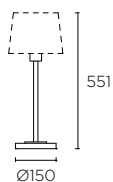

10-2757-14-82 + PAN



E27 max. 60W
Hal, Fluo, Led
A**... C

10-2757-14-82 + PAN-161-BY

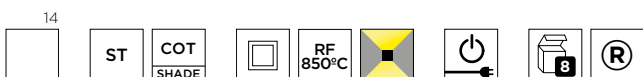



DECORATIVE | DRESS UP

25-2757-14-82 + PAN



E27 max. 100W
Hal, Fluo, Led
A**... C

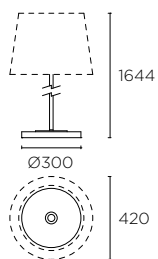

25-2757-14-82+ PAN-159-14



P. 262-264

14



LYON

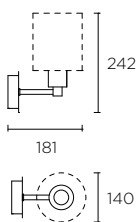
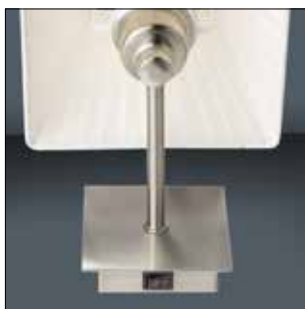

05-1567-81-82 + PAN



E27 max. 60W
Hal, Fluo, Led
A**... C



05-1567-81-82 + PAN-175-14

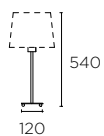
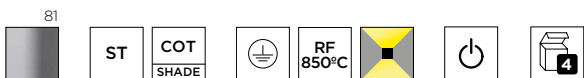

10-1567-81-82 + PAN



E27 max. 60W
Hal, Fluo, Led
A**... C

10-1567-81-82 + PAN-161-BY



P. 262-264





25-1567-81-82 + PAN-159-BY

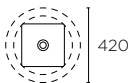
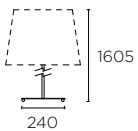

25-1567-81-82 + PAN



E27 max. 100W
Hal, Fluo, Led
A**... C



25-1567-81-82 + PAN-159-BY



DECORATIVE | DRESS UP

81



MILAN

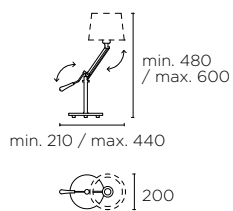

10-1568-81-82 + PAN-157-14



10-1568-81-82 + PAN



E27 max. 60W
Hal, Fluo, Led
A**... C

25-1568-81-82 + PAN-181-14

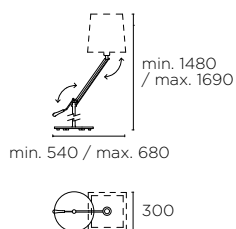

25-1568-81-82 + PAN



E27 max. 100W
Hal, Fluo, Led
A**... C



P. 262-264

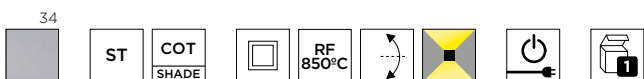



DECORATIVE | DRESS UP

OXFORD



05-2840-21-82 + PAN-157-14

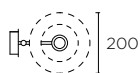
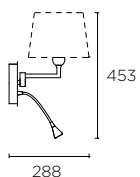

05-2840-21-82 + PAN



E27 max. 60W
Hal, Fluo, Led
Led **CREE** 1W
3000K | 94 lm
A... C A**... A**



P. 262-264

21

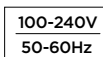

TYRA

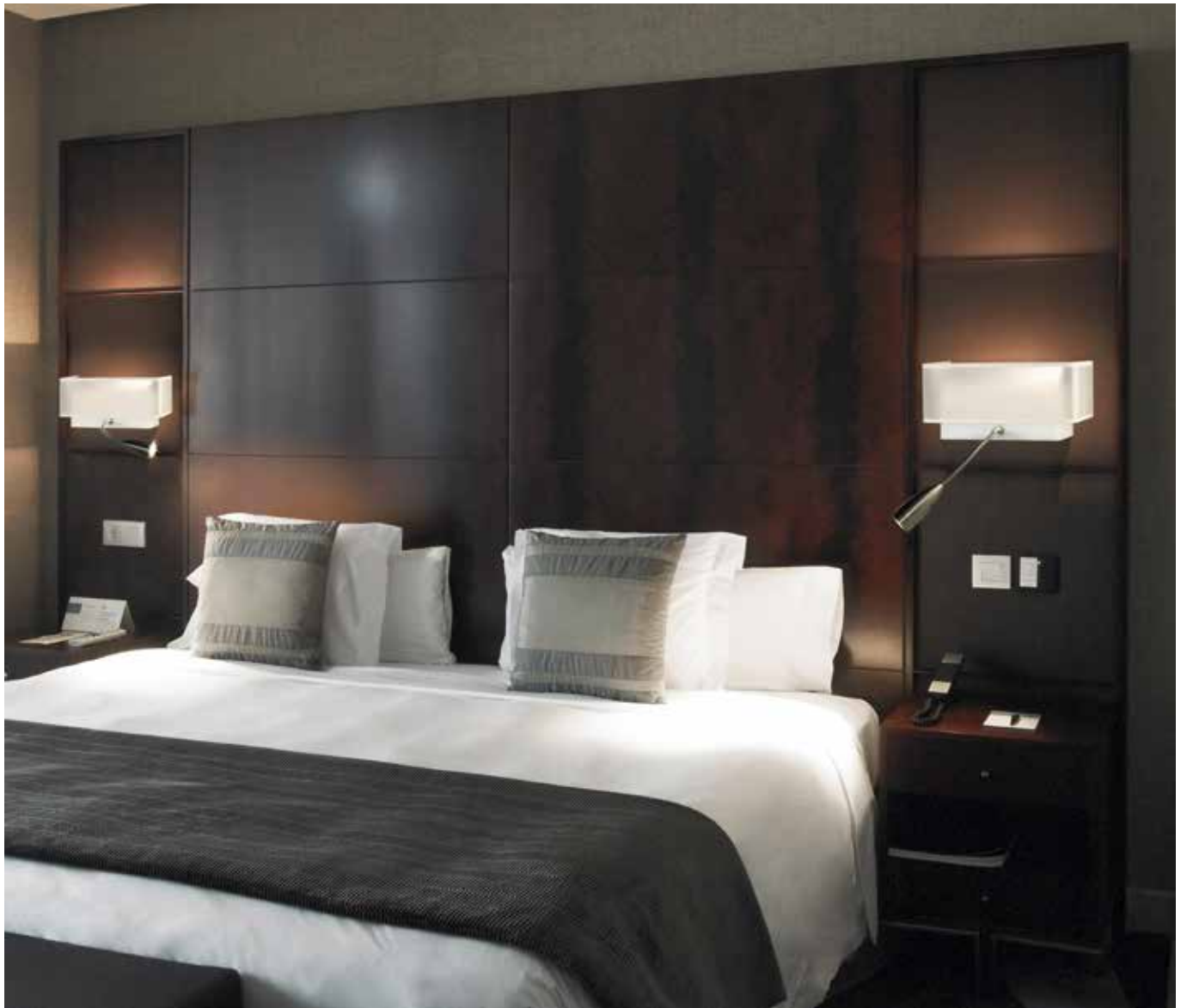

DECORATIVE | WALL & CEILING

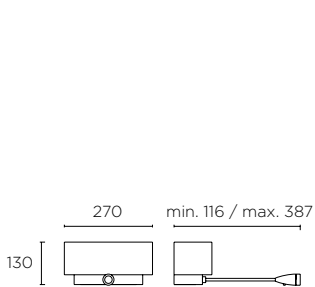

05-4363-81-20



G24Q2 max. 18W
 Led **CREE** 3W
 3000 K | 162 lm
A... C A**... A**



81

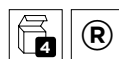
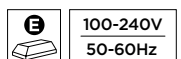
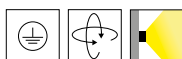

RACK NEW

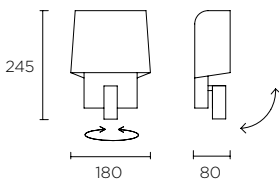
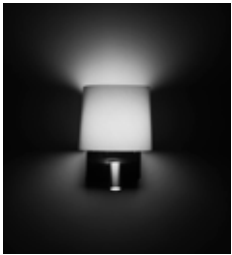

05-5447-81-14



Led **CREE** 7W
2700K | 550 lm
Led **CREE** 2,2W
2700K | 162 lm
A... A**



81 PAN 14

		AL	COT SHADE		IP 20				100-240V 50-60Hz	2x 				
--	--	----	--------------	--	----------	--	--	--	---------------------	--------	--	--	--	--



BUC

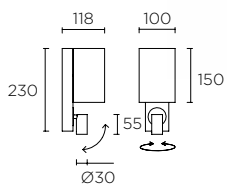
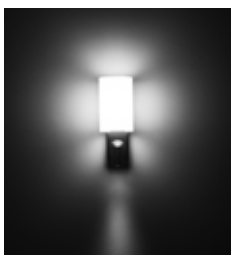

05-4901-19-E4



Led **CREE** 6,9W
3000K | 550 lm

Led **CREE** 2,2W
Hal, Fluo, Led
3000K | 162 lm
A... A**

Dos pantallas incluidas
Two shades included
Deux abat-jour fournis
Zwei Schirme enthalten
Due paralumi inclusi
Dois abat-jours incluidos
Включены два абажура
Zawiera dwa abażury

14 BY



E4 - 19 PAN 14 PAN 34





BALMORAL

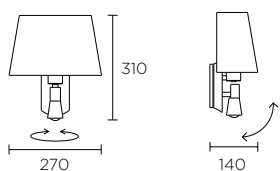

05-2814-81-14



05-2814-81-05



05-2814-81-20



E27 max. 60W | max. L 150 mm Ø 80 mm
 Hal, Fluo, Led
 Led **CREE** 2,2W
 3000K | 162 lm
A... C A**... A**

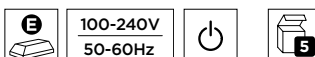

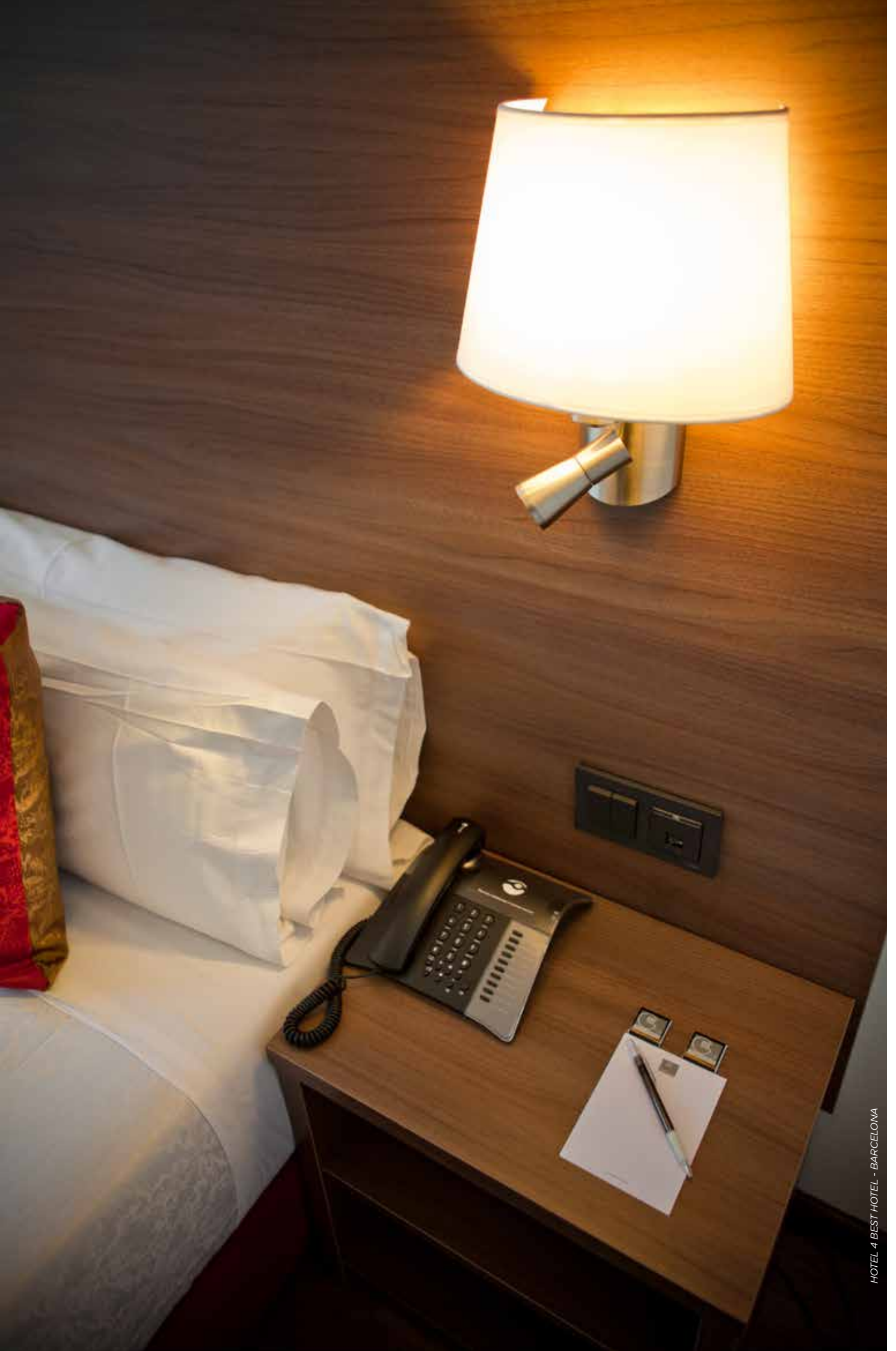

DIDO

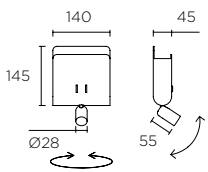

05-2015-14-14



Led **CREE** 9W
3000 K | 560 lm
Led **CREE** 1W
3000 K | 94 lm
A+... A

05-2015-34-34



ESTAK



DECORATIVE | WALL & CEILING



+

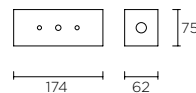
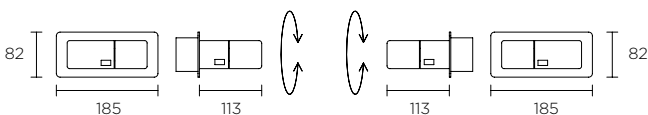
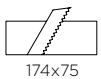

05-1555-34-34



Led **CREE** 3W
3000 K | 162 lm
A... A**

71-1653-34-34

Kit para empotrar en pared de obra
Recessing kit for brick wall
Kit pour encastrer au mur
Kit zum Einbauen im Mauerwerk
Kit da incasso a parete
Kit para encastrar em parede de obra
Набор для встроенного монтажа
Zestaw do montażu w ścianach z cegły

34



APPLY

NEW

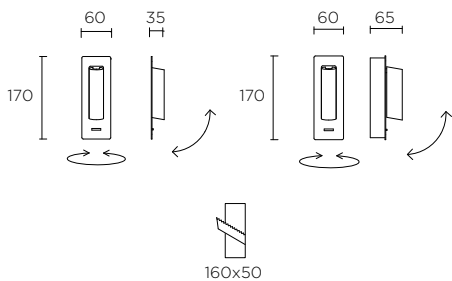

05-5315-14-14



05-5315-21-21



05-5315-81-81



Led **CREE** 2,2W
2700 K | 162 lm
A... A**

Doble instalación: empotrado/superficie
Double installation: recessed / surface
Double installation: encastré/surface
2 Installationsmöglichkeiten: Einbau / Aufbau
Doppia installazione: incassato o da superficie
Instalação dupla: embutido/superficie
Двойной системы установки: встроенный/поверхный
Podwójna instalacja: wpuszczana/natynkowa



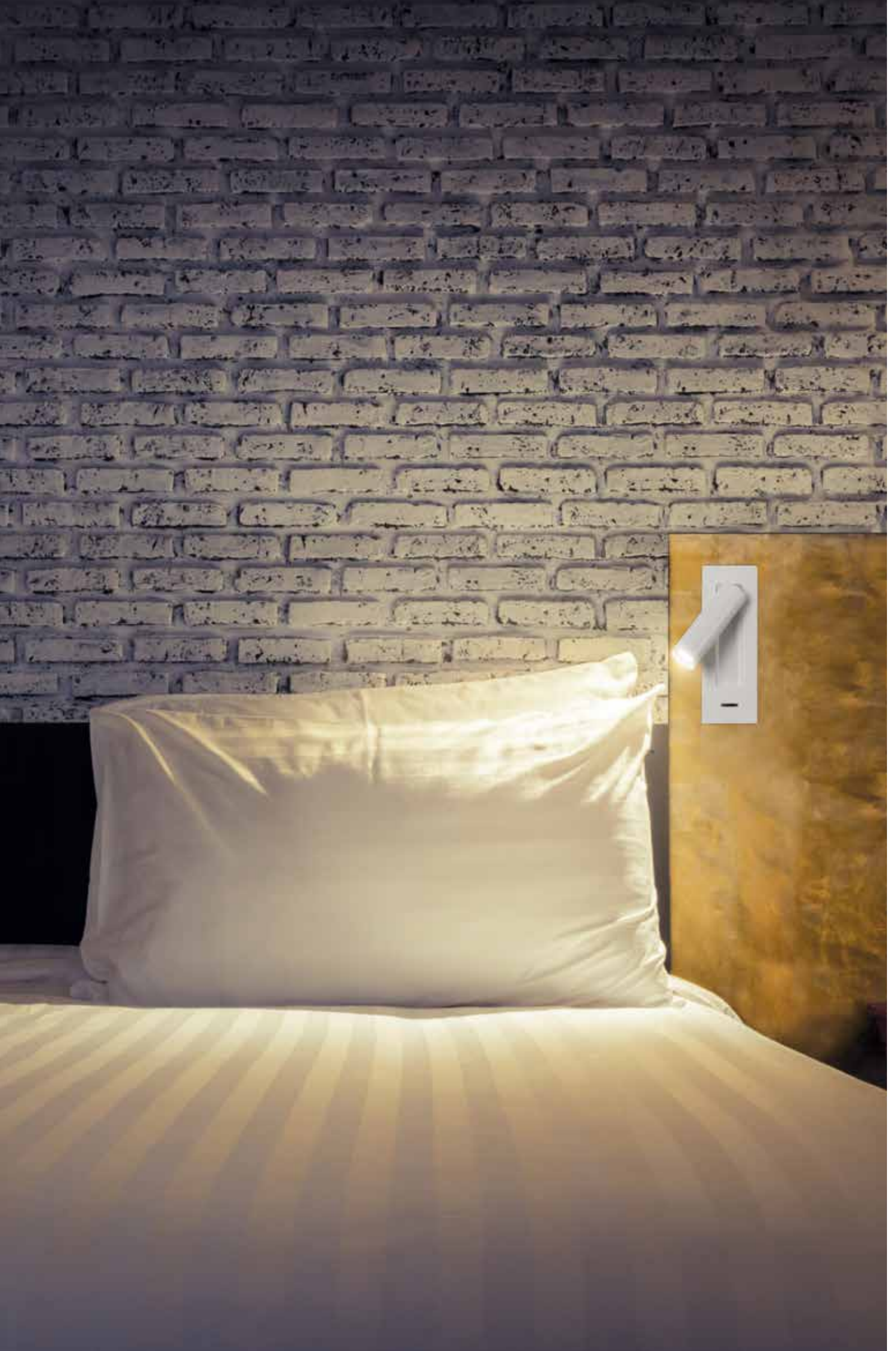

DECORATIVE | WALL & CEILING

ON-OFF

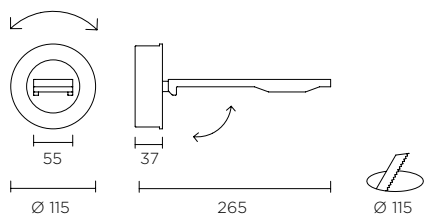

ON



OFF



05-0072-34-34



Led **CREE** 3W
3000 K | 162 lm
A++ ... C

Doble instalación: empotrado/superficie
Double installation: recessed / surface
Double installation: encastré/surface
2 Installationsmöglichkeiten: Einbau / Aufbau
Doppia installazione: incassato o da superficie
Instalação dupla: embutido/superficie
Двойной системы установки: встроенный/поверхный
Podwójna instalacja: wpuszczana/natynkowa



IVY



DECORATIVE | WALL & CEILING

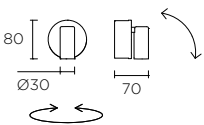

05-2706-81-81



Led **CREE** 1W
3000 K | 94 lm
A++ ... A

05-2706-21-21



05-2706-E4-E4



Doble instalación: empotrado/superficie
Double installation: recessed / surface
Double installation: encastré/surface
2 Installationsmöglichkeiten: Einbau / Aufbau
Doppia installazione: incassato o da superficie
Instalação dupla: embutido/superficie
Двойной системы установки: встроенный/поверхный
Podwójna instalacja: wpuszczana/natynkowa

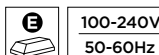

TIP

NEW

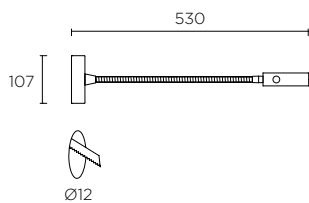

05-5296-81-81



Led **CREE** 2,2W
3000 K | 162 lm
Hal, Fluo, Led
A... A**



Doble instalación: empotrado/superficie
Double installation: recessed / surface
Double installation: encastré/surface
2 Installationsmöglichkeiten: Einbau / Aufbau
Doppia installazione: incassato o da superficie
Instalação dupla: embutido/superficie
Двойной системы установки: встроенный/поверхный
Podwójna instalacja: wpuszczana/natynkowa

81





BOOK

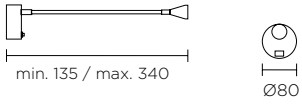

05-2838-21-21



Led **CREE** 1W
3000 K | 94 lm
A**... A

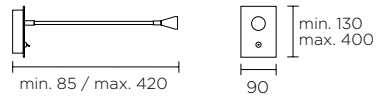

05-2837-21-21



Led **CREE** 1W
3000 K | 94 lm
A**... A

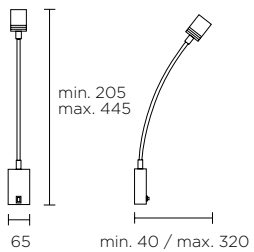

05-2845-21-21



Led **CREE** 3W
3000 K | 162 lm
A**... A



WALL

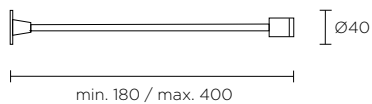

05-2835-54-54



Led **CREE** 1,2W
3000 K | 94 lm
A**... A



BED

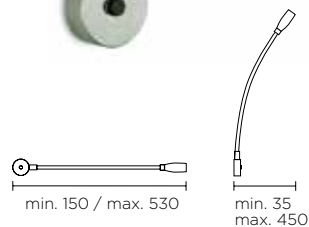

05-2830-34-34



Led **CREE** 3W
3000 K | 162 lm
A**... A

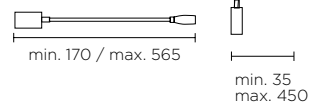
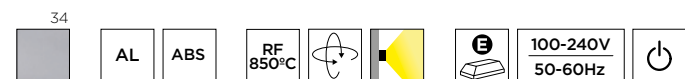

05-2831-34-34



Led **CREE** 3W
3000 K | 162 lm
A**... A



LLIT



446-NS



Led **CREE** 2,5W
6000 K | 242 lm
A**... A

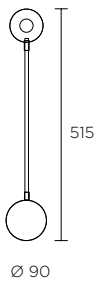

ROOMIE



DECORATIVE | WALL & CEILING



Ø120 58

FILTROS INCLUIDOS | SIGNAL FILTERS INCLUDED | FILTRES DE SIGNALISATION FOURNIS
 FILTER FÜR SIGNALISIERUNG INKLUSIVE | FILTRI DI SEGNALAZIONE INCLUSI | SINLIZAÇÃO, INCLUINDO FILTROS
 ФИЛЬТРЫ С ОБОЗНАЧЕНИЯМИ В КОМПЛЕКТЕ | FILTRY SYGNAŁÓW W KOMPLECIE

05-2753-14-M2



Led **CREE** 1W
 3000 K | 107 lm
A... A**



14

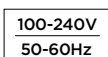

QUEEN

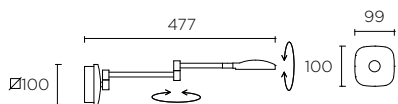

05-4760-21-05



05-4760-E4-Y2



Led **CREE** 6,9W
3000 K | 550 lm
A**... A

21-05 E4-Y2



P. 402

P. 402

P. 404

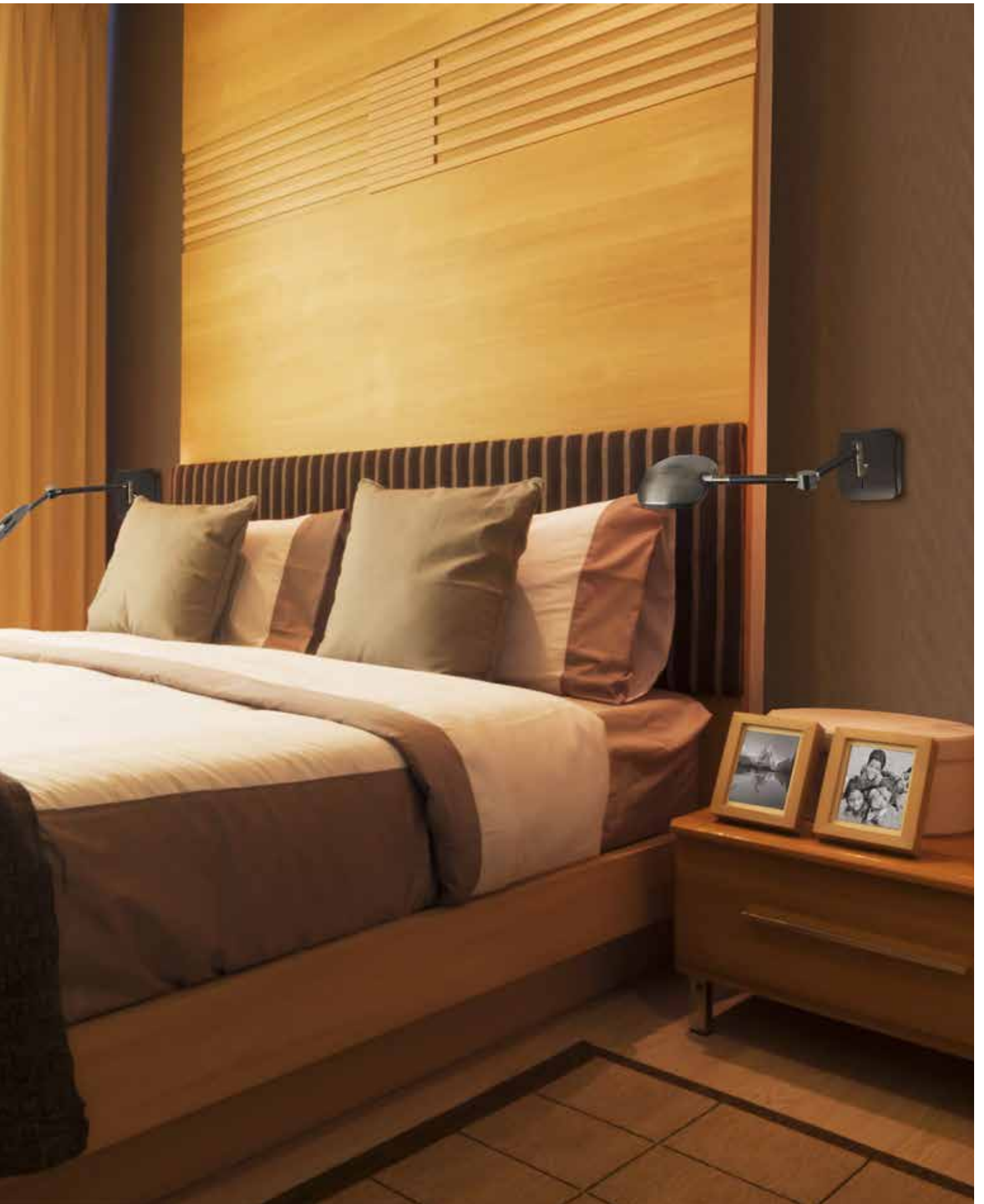

DECORATIVE | WALL & CEILING

FLEX



05-1530-21-14



05-1530-21-05



E27 max. 60W | max. L 130 mm Ø 70 mm

RECOMMENDED GLOBE 11W

Hal, Fluo, Led

A**... C

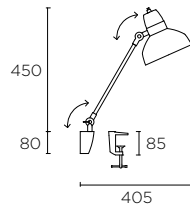

05-1531-21-14



05-1531-21-05



E27 max. 60W | max. L 130 mm Ø 70 mm

RECOMMENDED GLOBE 11W

Hal, Fluo, Led

A**... C

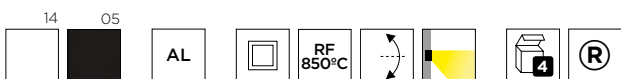
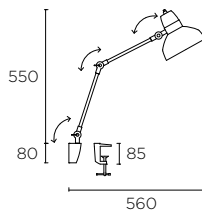

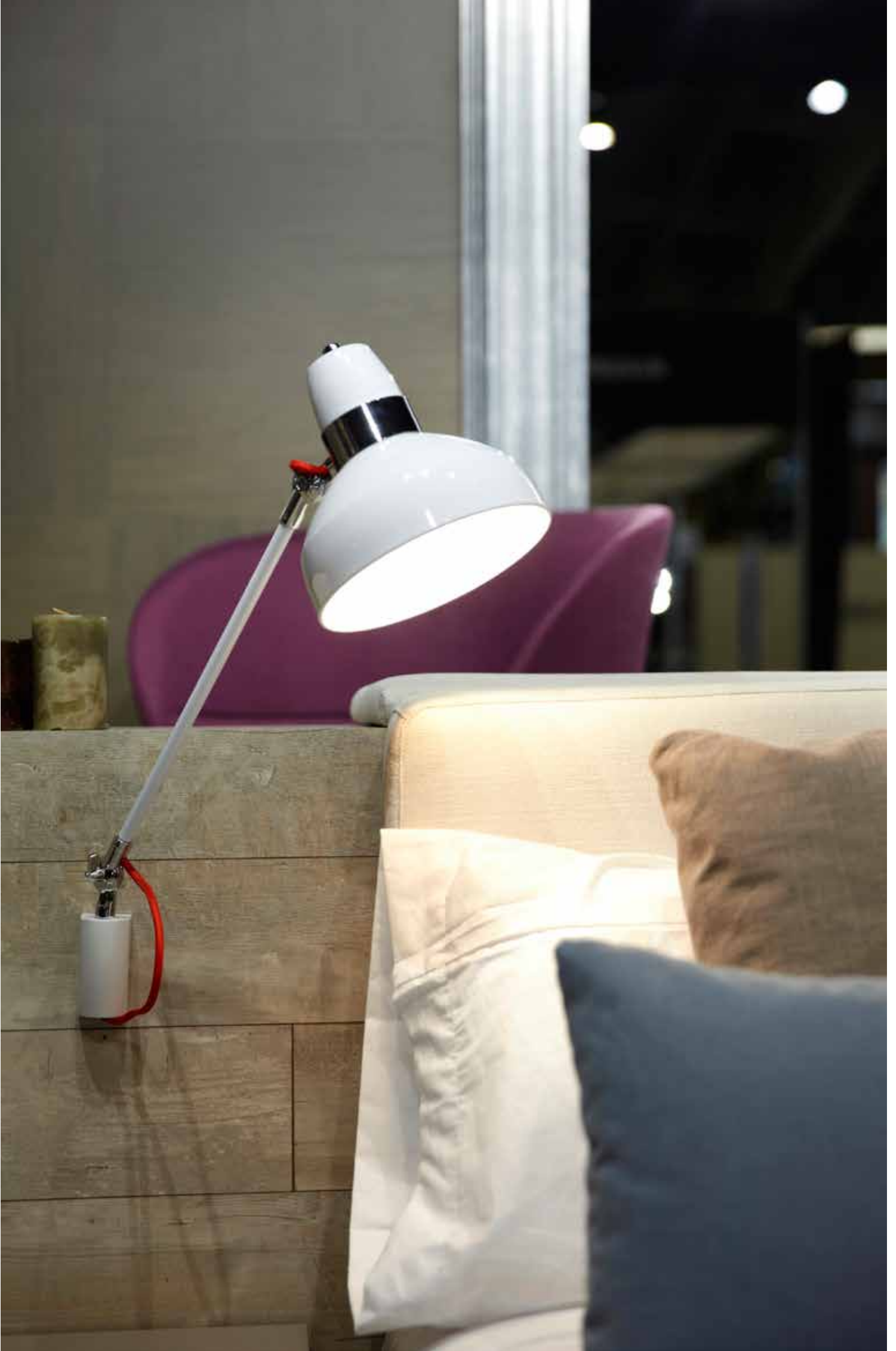

SIENA LED

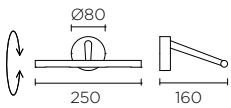

05-1577-E4-M2



Led 2,4W
3000 K | 265 lm
A**... A

05-1577-21-M2



05-1577-81-M2

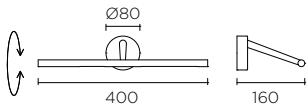

05-1611-E4-M2



Led 3,6W
3000 K | 400 lm
A**... A

05-1611-21-M2



05-1611-81-M2

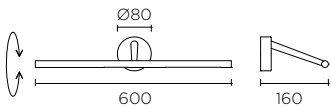

05-2897-E4-M2



Led 7W
3000 K | 700 lm
A**... A

05-2897-21-M2



05-2897-81-M2

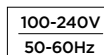

SIENA



DECORATIVE | WALL & CEILING

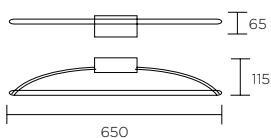

280-NS



T5 13W
A**... C

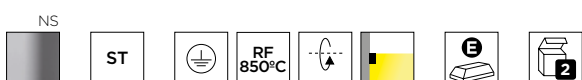

KUB

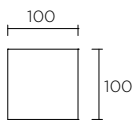
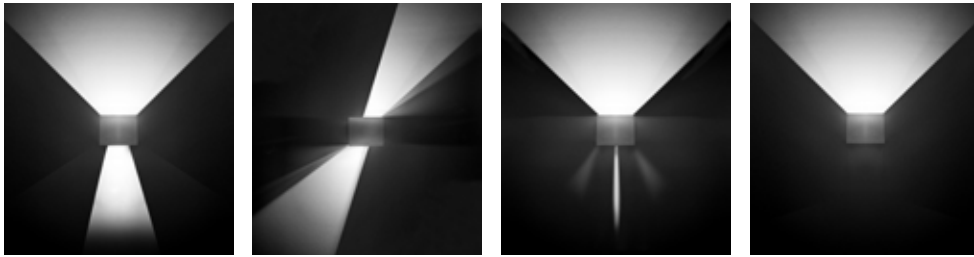

05-3220-34-34



05-3220-25-25



05-3220-14-14



Led **CREE** 4,1W
3000 K | 428 lm
A... A**

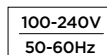
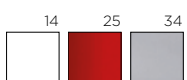

JET

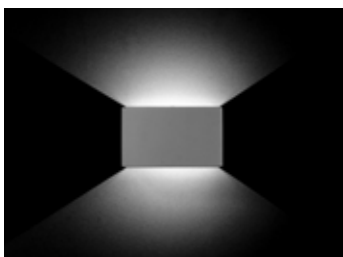

DECORATIVE | WALL & CEILING

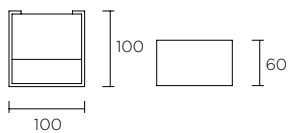

05-0071-14-14



Led **CREE** 3W
3000 K | 182 lm
A... A**

14

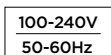

JET

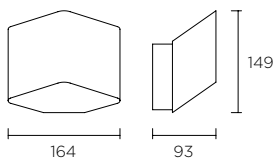
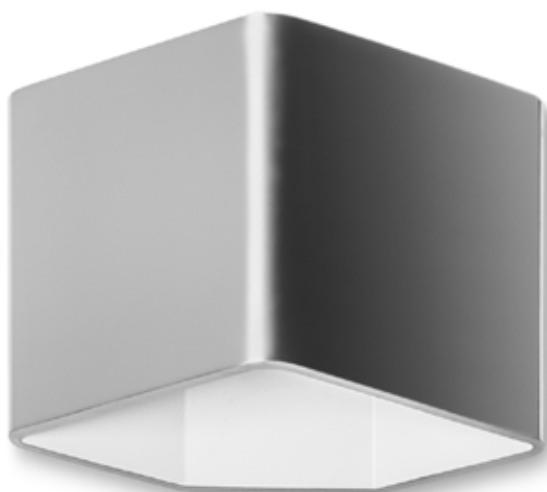

05-3980-14-14



05-3980-S2-14



Led **SHARP** 7,5W
3000 K | 700 lm
A... A**

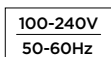



NEU

NEW

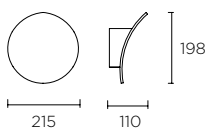
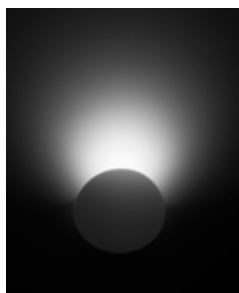

05-5330-14-14



05-5330-S2-14



Led **SHARP** 13W
2700 K | 1700 lm
A**... A

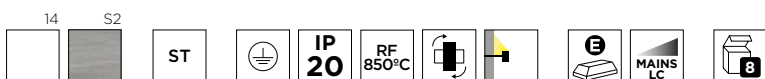

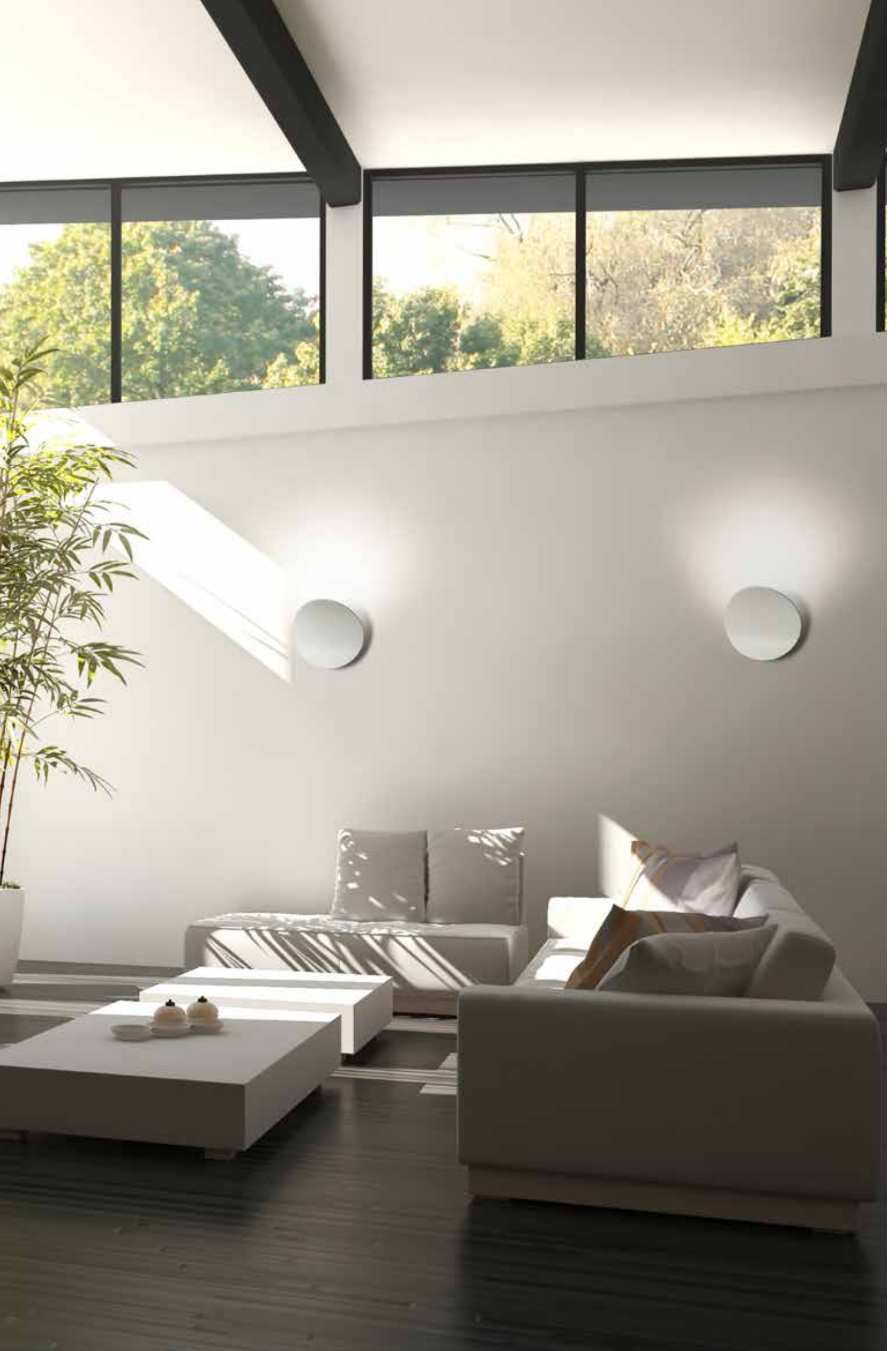

SKATE

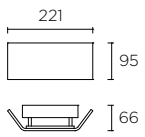
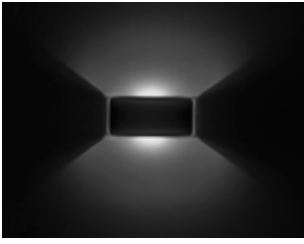

05-4931-93-93

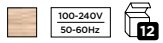

Led **SHARP** 7,5W
3000 K | 700 lm
A**... A

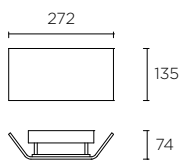

05-5048-93-93



Led **SHARP** 9W
3000 K | 920 lm
A**... A

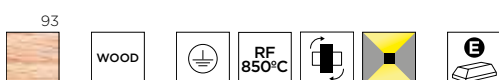



GES



05-1793-14-14



E14 max. 40W | max. L 129 mm Ø 45 mm
Hal, Fluo, Led
A**... C

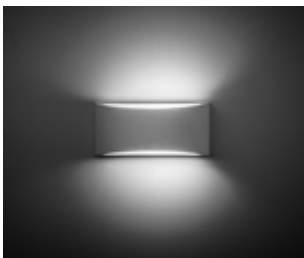
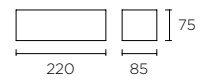

05-1796-14-14



E14 max. 40W | max. L 129 mm Ø 45 mm
Hal, Fluo, Led
A**... C

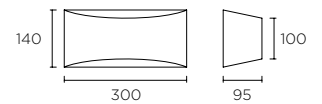

05-1795-14-14



R7s max. 100W | max. L 78 mm
A**... C

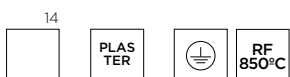
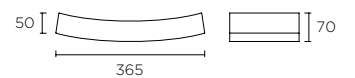

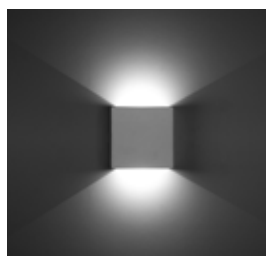

05-1798-14-14V1



Led **CREE** 4,4W
3000 K | 330 lm
A**... A

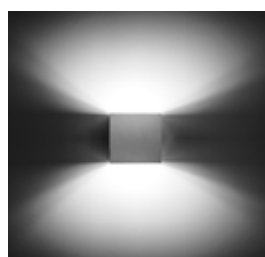
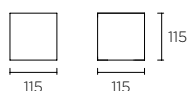

05-1794-14-14



G9 max. 40W
A**... C

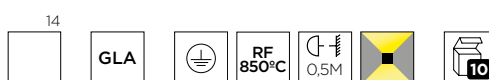
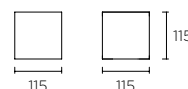

OVAL

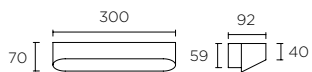

05-2019-14-14



05-2019-S2-14



Led **CITIZEN** 9,6W
3000 K | 820 lm
A... A**

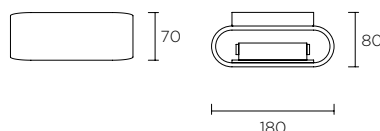
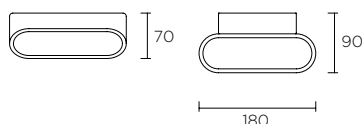

05-0070-14-14



05-0070-S2-14



Led **CITIZEN** 4,8W
3000 K | 488 lm
A... A**

05-0534-14-14



R7s max. 100W
A... C**





LIA LED

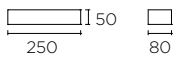
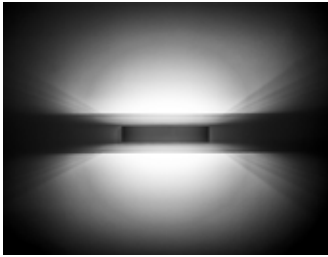

05-2703-81-81V1



05-2703-21-21V1



05-2703-14-14V1



Led 6,7W
3000 K | 630 lm
A**... A

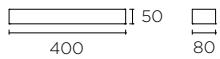

05-2704-81-81V1



05-2704-21-21V1



05-2704-14-14V1



Led 14,4W
3000 K | 1260 lm
A**... A

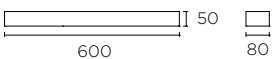

05-2705-81-81V1



05-2705-21-21V1



05-2705-14-14V1



Led 20,8W
3000 K | 1925 lm
A**... A

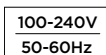

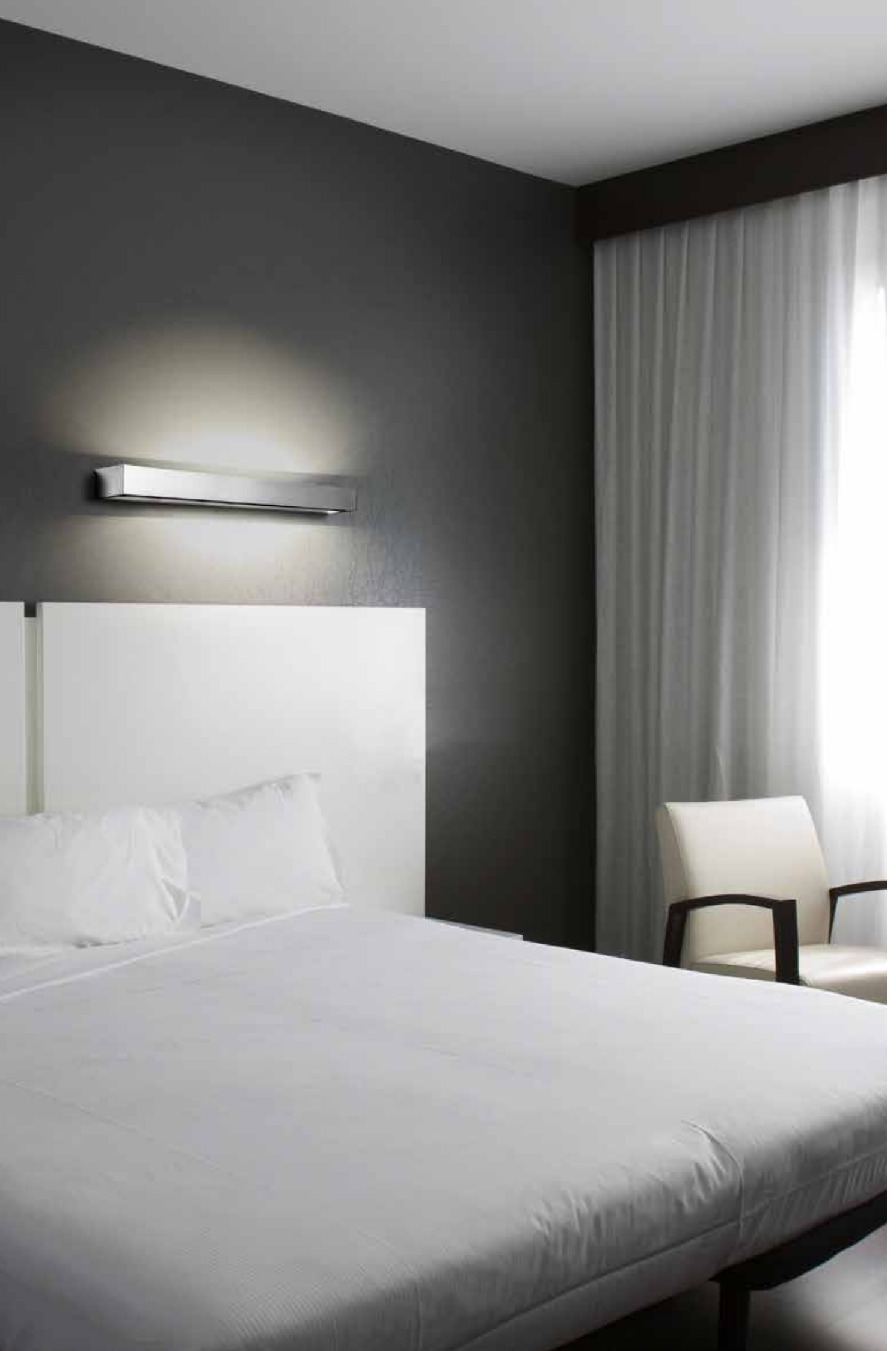

LIA

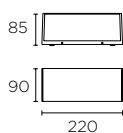
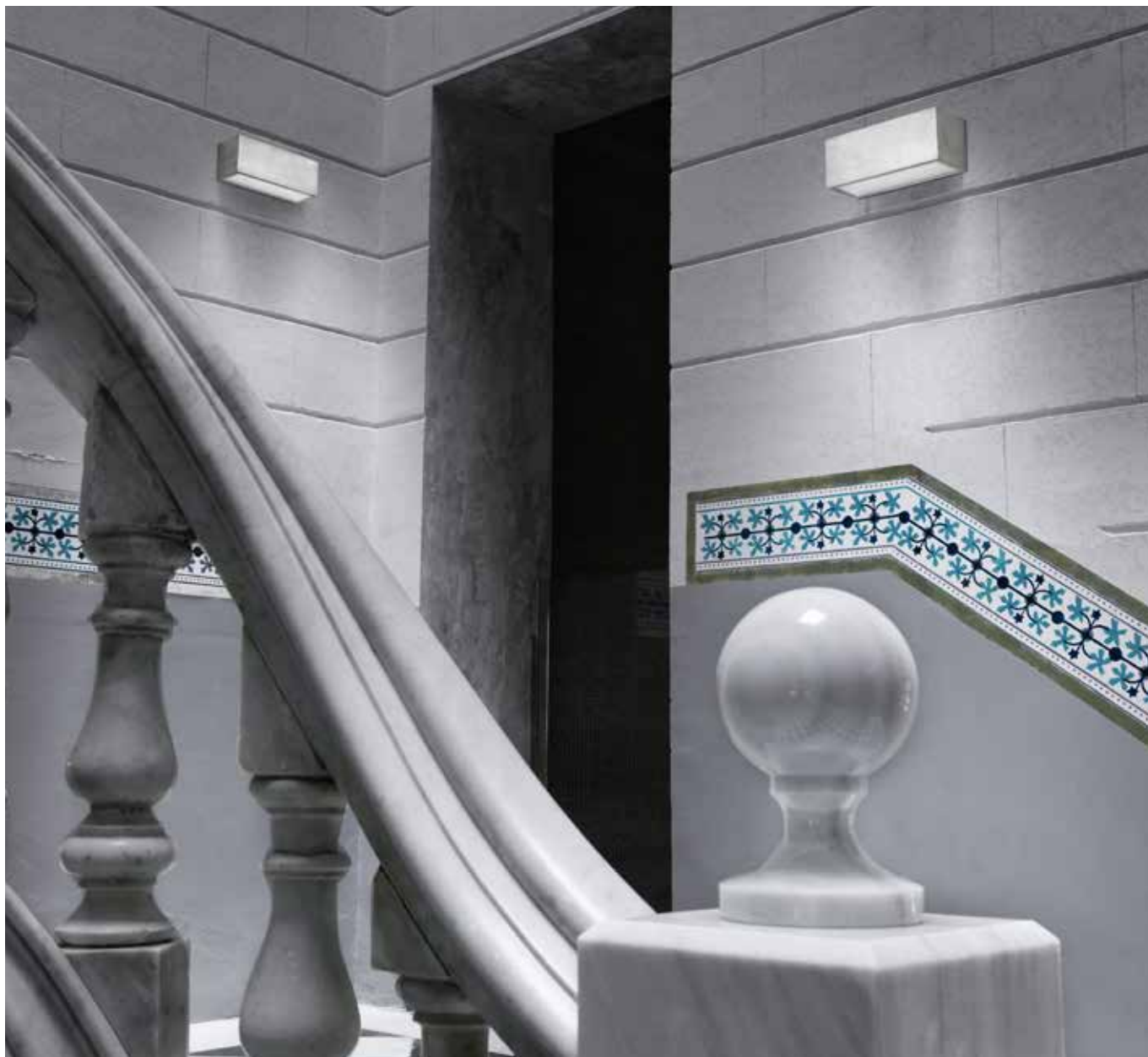

05-4401-14-B8



E27 max. 60W | max. L 160 mm Ø 70 mm
Hal, Fluo, Led
A**... C

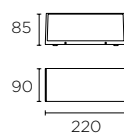

05-4401-BX-B8



E27 max. 60W | max. L 160 mm Ø 70 mm
Hal, Fluo, Led
A**... C



NEMESIS



DECORATIVE | WALL & CEILING

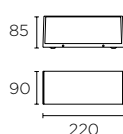
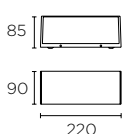

05-9177-14-B8

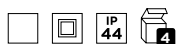

R7s max. 100W | max. L 78 mm
A**... C

05-4402-BX-B8

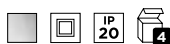

R7s max. 100W | max. L 78 mm
A**... C

05-9800-14-CL



Led **SAMSUNG** 5,3W
3000K | 644 lm
A**... A

71-8969-00-00

Reactancia para:
Ballast for:
Ballast pour:
Vorschaltgerät für:
Reattanza per:
Reactivância para:
активное сопротивление для:
Reaktancja dla:
PL-G24d-13W 230V



BREMEN

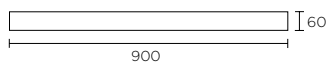
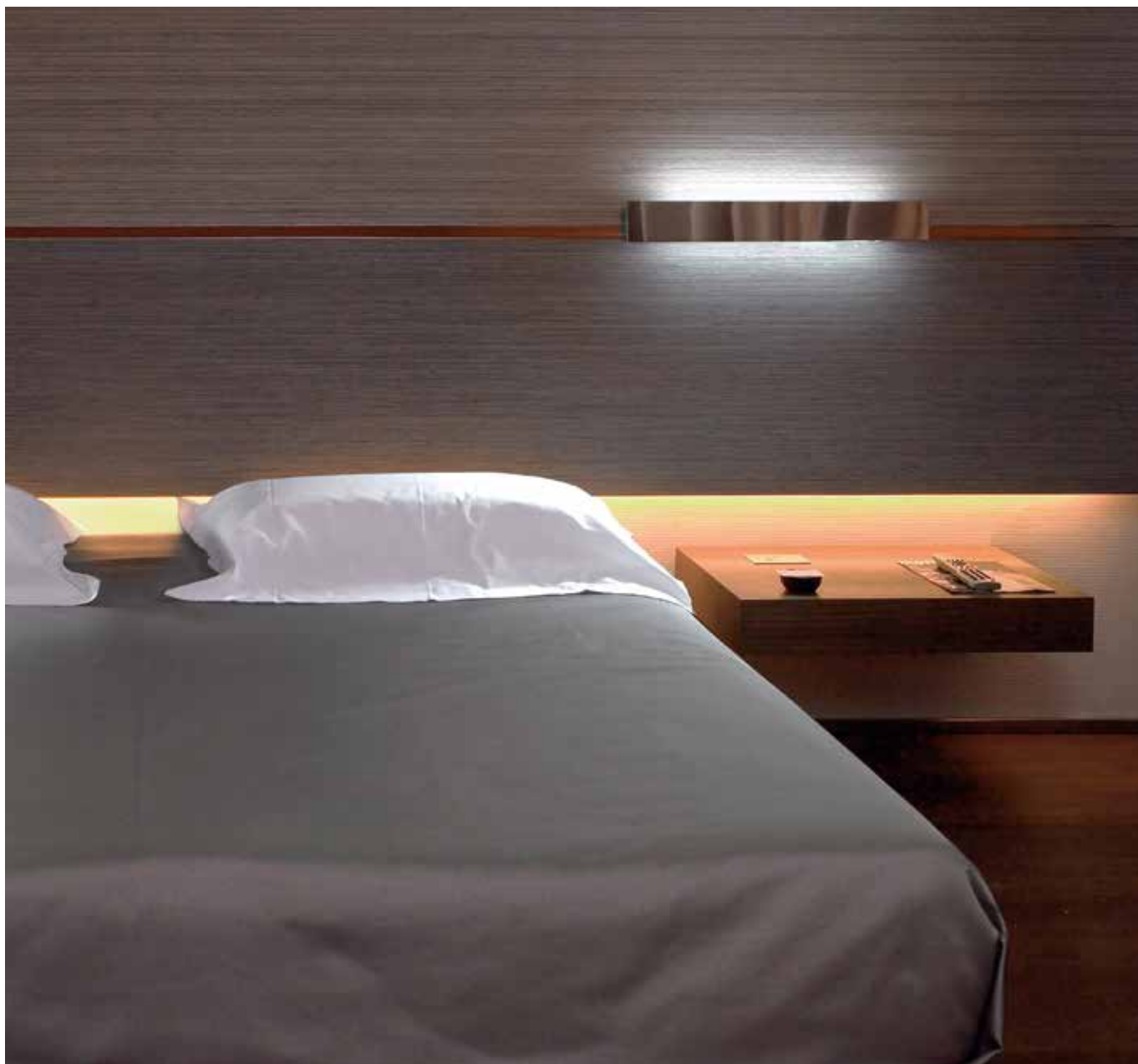

284-CR



2xT5 21W
A**... C

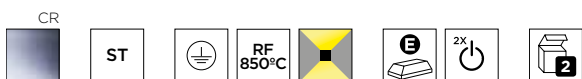

HALF



DECORATIVE | WALL & CEILING

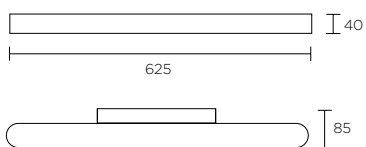

493-CR



T5 14W
A**... C

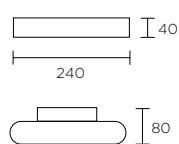

492-CR



R7s max. 150W | max. L 118 mm
OSRAM INCLUDED
A**... C

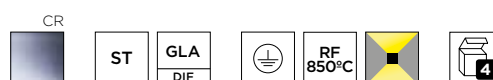

SUNNY

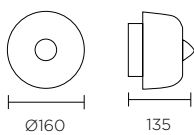
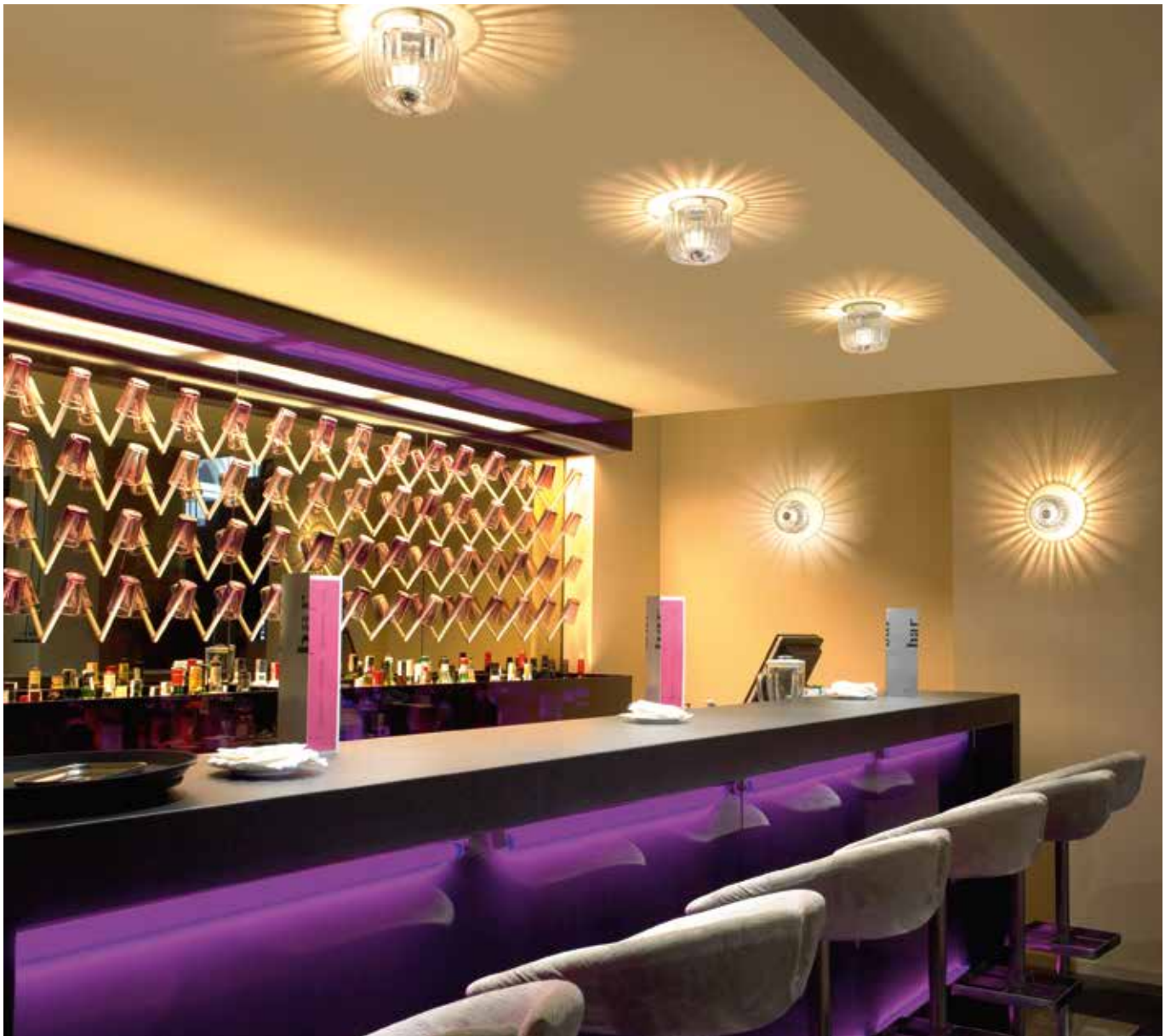

510-CR



E14 max. 40W | max. L 70 mm Ø 70 mm
Decor Silver 2700K Warm White **INCLUDED**
Hal, Fluo, Led
A... C**



ALU



DECORATIVE | WALL & CEILING

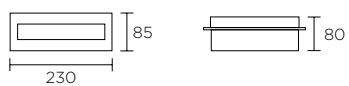

443-AL



R7s 150W | max. L 118 mm
OSRAM INCLUDED
 A**... C

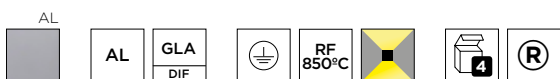

PRACTIC

05-0517-21-E9



E27 max. 100W | max. L 200 mm Ø 60 mm
Fluo, Led
A**... C

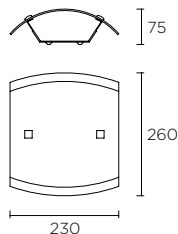

05-0518-21-E9



2xE27 max. 60W | max. L 200 mm Ø 60 mm
Hal, Fluo, Led
A**... C

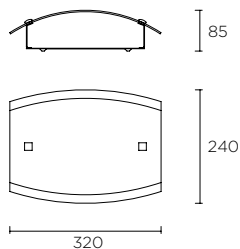

05-0519-21-E9



E27 max. 100W | max. L 190 mm Ø 60 mm
Hal, Fluo, Led
A**... C

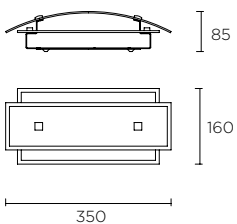

05-1760-21-E9



2xE27 max. 60W | max. L 135mm Ø 55 mm
Hal, Fluo, Led
A**... C

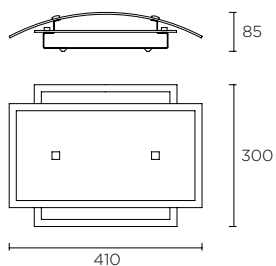

21



NIZA

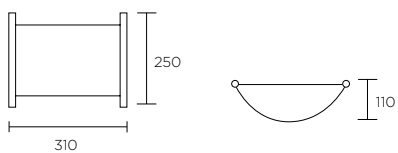

274-NS



2xE27 max. 60W | max. L 160 mm Ø 60 mm
Hal, Fluo, Led
A... C**

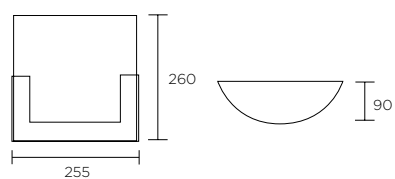

505-NS



2xE27 max. 60W | max. L 190 mm Ø 60 mm
Hal, Fluo, Led
A... C**

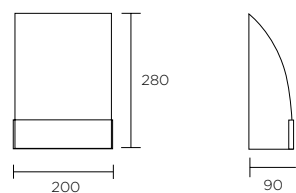

506-CR



2xE27 max. 60W | max. L 120 mm Ø 60 mm
Hal, Fluo, Led
A... C**



DECORATIVE | WALL & CEILING



LUGO

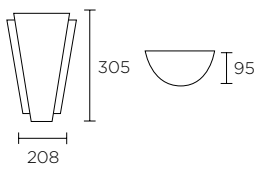

482-CR



E27 max. 100W | max. L 130 mm Ø 80 mm
Hal, Fluo, Led
A**... C

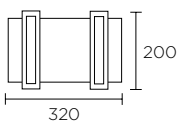

479-CR



2xE27 max. 60W | max. L 140 mm Ø 40 mm
Hal, Fluo, Led
A**... C



CR-Y2



GLASS



HOTEL 4 BEST HOTELS - BARCELONA



DECORATIVE | WALL & CEILING

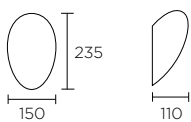

444-BL



E27 max. 100W | max. L 130 mm Ø 70 mm
Hal, Fluo, Led
A**... C

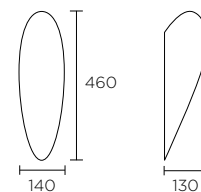

445-BL



E27 max. 60W | max. L 220 mm Ø 70 mm
Hal, Fluo, Led
A**... C



VESPA

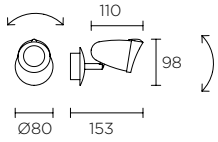

05-0848-16-21



GU10 Led 6W

RECOMMENDED ACT-FLL-025

Led

A**... C

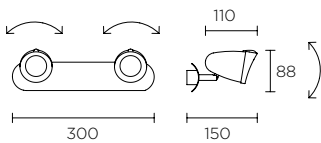

05-0849-16-21



2xGU10 Led 6W

RECOMMENDED ACT-FLL-025

Led

A**... C

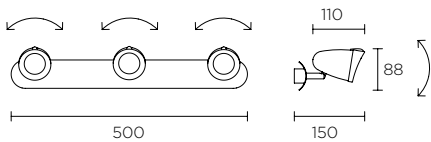

05-0850-16-21



3xGU10 Led 6W

RECOMMENDED ACT-FLL-025

Led

A**... C



16 - 21



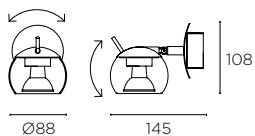

05-4351-21-37



GU10 max. 50W

RECOMMENDED ACT-FLL-025

Hal, Led

A**... C

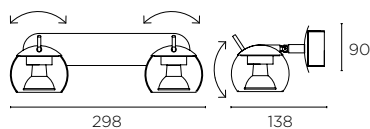

05-4352-21-37



2xGU10 max. 50W

RECOMMENDED ACT-FLL-025

Hal, Led

A**... C



21



TRINITY

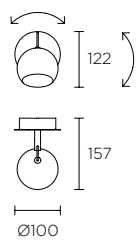

05-1513-21-21



GU10 Led 6W

RECOMMENDED ACT-FLL-025

Led

A**... C

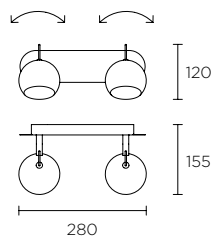

05-1514-21-21



2xGU10 Led 6W

RECOMMENDED ACT-FLL-025

Led

A**... C

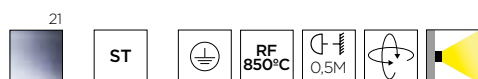



DRONE

NEW

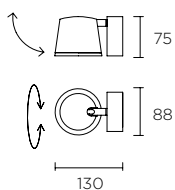

05-5306-14-21



05-5306-14-06



05-5306-CI-21



05-5306-CI-06



Led **CREE** 7W
2700 K | 550 lm
A**... A

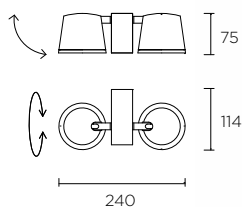

05-5307-14-21



05-5307-14-06



05-5307-CI-21



05-5307-CI-06



Led **CREE** 14W
2700 K | 1100 lm
A**... A

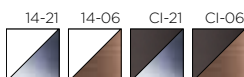



DRONE

NEW

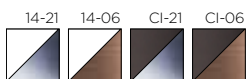

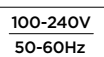
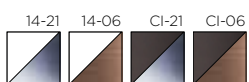

WOOD

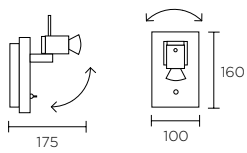

410-CR



GU10 max. 50W **OSRAM INCLUDED**
RECOMMENDED ACT-FLL-025 
 Hal, Led
A... C**

CR - J6

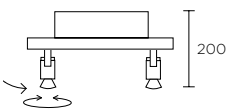
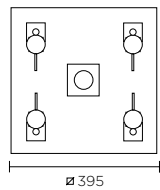

415-CR



5xGU10 max. 50W **OSRAM INCLUDED**
RECOMMENDED ACT-FLL-025 
 Hal, Led
A... C**

CR - J6



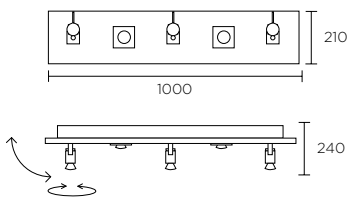

416-CR



5xGU10 max. 50W **OSRAM INCLUDED**
RECOMMENDED ACT-FLL-025 
 Hal, Led
 A**... C



CR - J6

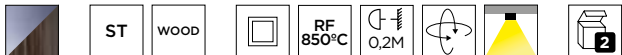

SATURN

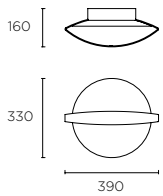
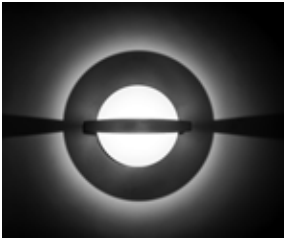

15-2021-14-14

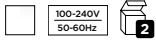

Led **SHARP** 18W
3000 K | 1800 lm
A++... A

15-5073-14-14

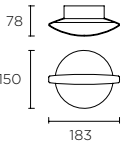

05-2233-14-14

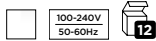

Led **CITIZEN** 4W
3000 K | 380 lm
A++... A

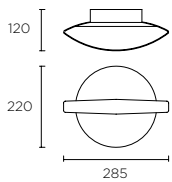

15-2020-14-14

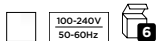

Led **SHARP** 9W
3000 K | 920 lm
A++... A

15-5069-14-14

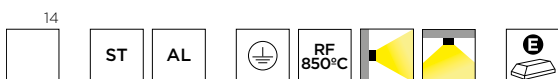



DECORATIVE | WALL & CEILING

STRATA

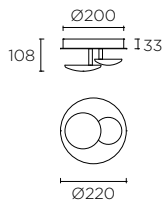

05-4921-21-14

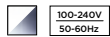

05-4921-06-14



05-4968-21-14



05-4968-06-14



Led **CREE** 14W
3000 K | 1100 lm
A... A**

14 - 21 14 - 06

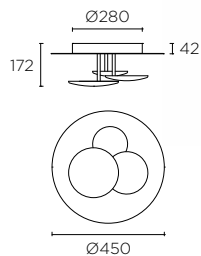
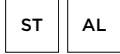
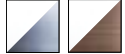

15-4921-21-14

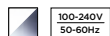

15-4921-06-14

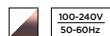

15-4968-21-14



15-4968-06-14



Led **CREE** 39W
3000 K | 3700 lm
A... A**

14 - 21 14 - 06

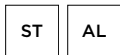



WOW

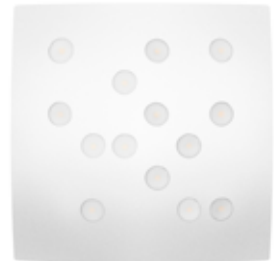
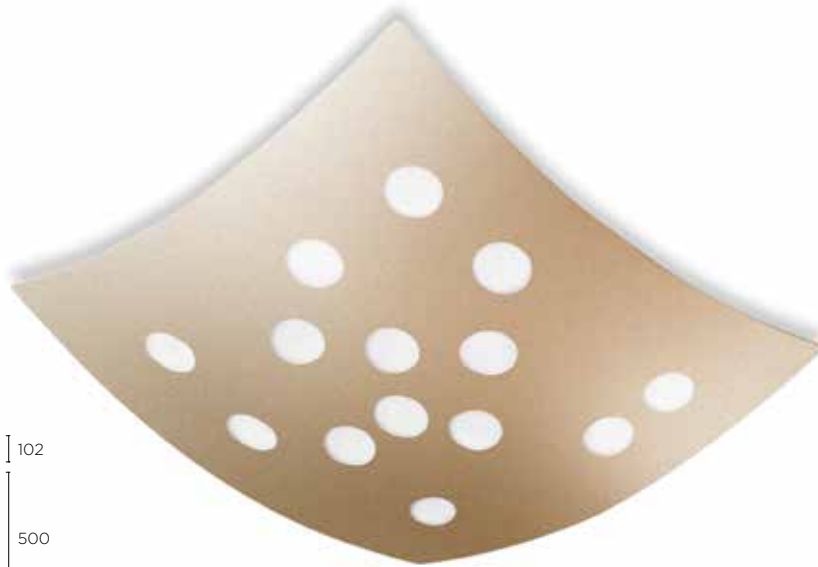

15-4969-14-14

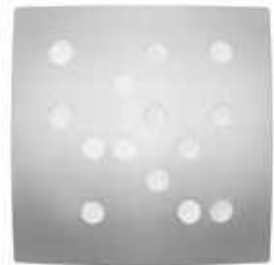

15-4969-34-34

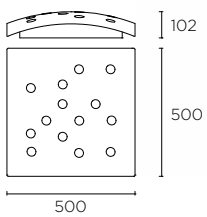

15-4969-14-14



15-4969-F5-F5



15-4969-34-34



Led **SAMSUNG** 49W
3000 K | 3200 lm
A**... A



15-4849-F5-F5



15-4849-34-34

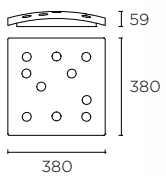

15-4849-14-14



15-4849-F5-F5



15-4849-34-34



Led **SAMSUNG** 35W
3000 K | 2300 lm
A**... A

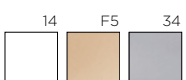



BOL

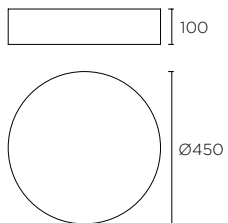

15-4922-BY-M1



Led 19W
3000K | 1710 lm

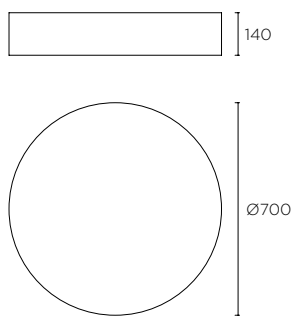

15-4924-BY-M1



Led 29W
3000K | 2590 lm

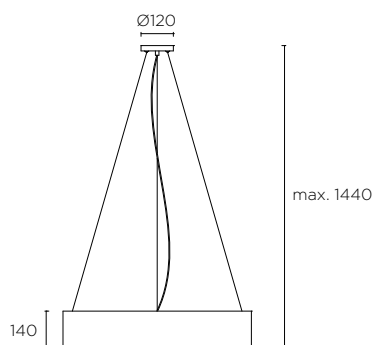

71-4695-81-81



15-4922-BY-M1 + 71-4695-81-81 (Ø450)
15-4924-BY-M1 + 71-4695-81-81 (Ø700)



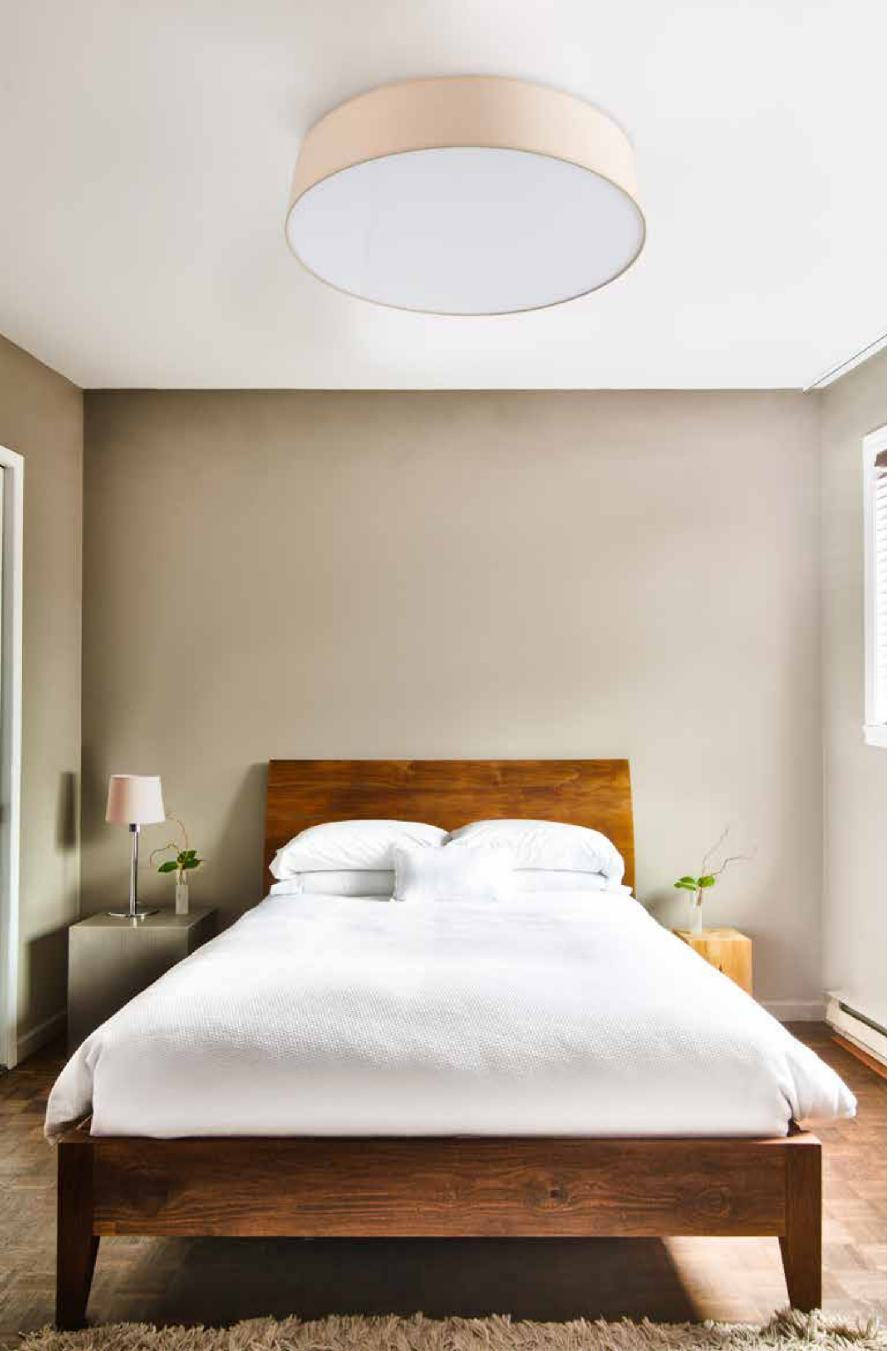

FLORENCIA



15-4695-J6-M1



15-4695-20-M1



2xE27 max. 40W | max. L 160 mm Ø 50 mm

Hal, Fluo, Led

A**... C



15-4696-J6-M1



15-4696-20-M1



3xE27 max. 40W | max. L 200 mm Ø 50 mm

Hal, Fluo, Led

A**... C

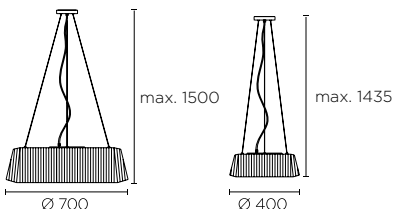

71-4695-81-81



15-4695-XX-M1 + 71-4695-81-81 (Ø400)

15-4696-XX-M1 + 71-4695-81-81 (Ø700)



PAN J6 PAN 20





TOLEDO

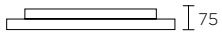
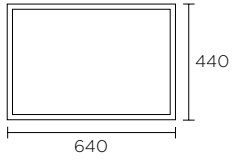

15-2906-S2-M1



2x2G11 55W
A**... C

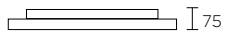
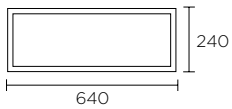

434-AL



2x2G11 40W
A**... C

15-2939-S2-M1V1

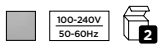

Led 29W
3000 K | 2565 lm
A**... A

15-5067-S2-M1V1



Led 29W
3000 K | 2565 lm
A**... A



15-2940-S2-M1V1

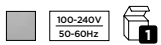

Led 38W
3000 K | 3420 lm
A**... A

15-5068-S2-M1V1



Led 38W
3000 K | 3420 lm
A**... A



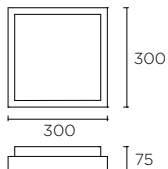

15-2936-S2-M1V1

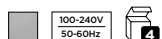

Led 19W
3000 K | 1710 lm
A**... A

15-5062-S2-M1V1



Led 19W
3000 K | 1710 lm
A**... A

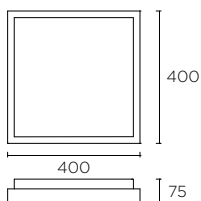

15-2937-S2-M1V1

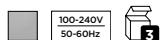

Led 29W
3000 K | 2590 lm
A**... A

15-5063-S2-M1V1



Led 29W
3000 K | 2590 lm
A**... A

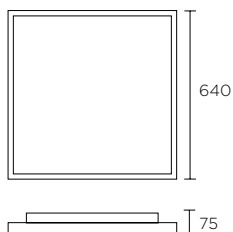

15-2907-S2-M1



2x2G11 55W
A**... C

15-2938-S2-M1V1

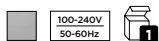

Led 58W
3000 K | 5180 lm
A**... A

15-5064-S2-M1V1



Led 58W
3000 K | 5180 lm
A**... A



RAS



15-4686-14-M1



2G11 55W
A**... C

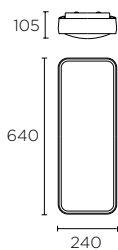

15-4685-14-M1



2xE27 max. 18W | max. L 190 mm Ø 60 mm
Hal, Fluo, Led
A**... C

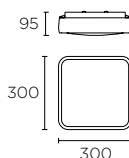

15-4687-14-M1



2x2G11 55W
A**... C

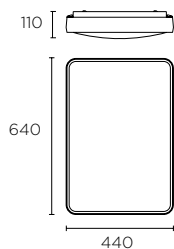

15-4688-14-M1



3x2G11 55W
A**... C

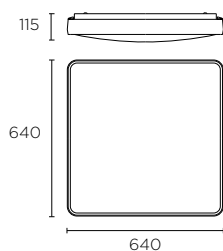

14





ALPEN

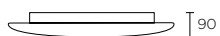
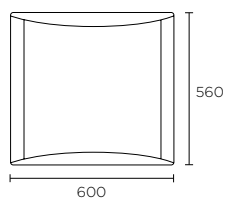

15-2905-34-M1



3x2G11 24W
A**... C

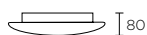
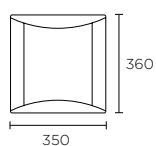

332-GR



2xG24q3 26W
A**... C



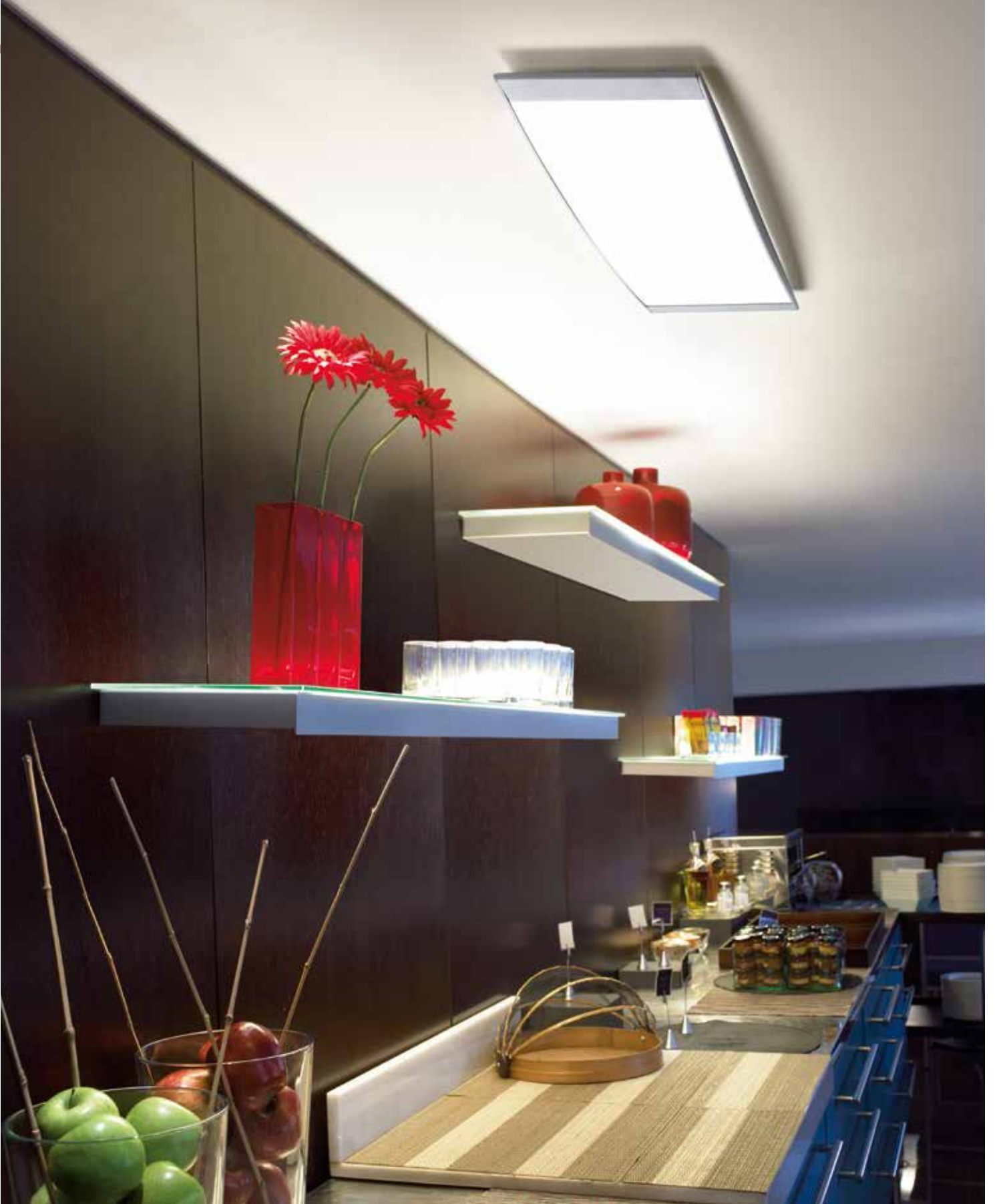

331-GR



2x2G11 40W
A**... C

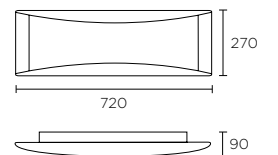

CLIP



15-4684-21-E9



3xE27 max. 40W
max. L 200 mm Ø 60 mm
Hal, Fluo, Led
A**... C

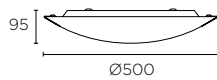

15-4682-21-E9



2xE27 max. 25W
max. L 140 mm Ø 55 mm
Hal, Fluo, Led
A**... C



21

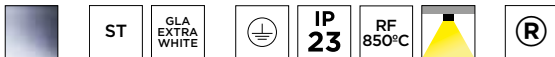

15-1522-21-E9



Led 16,6W
3000 K | 1800 lm
A**... A

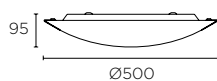

15-1521-21-E9



Led 12,8W
3000 K | 1400 lm
A**... A

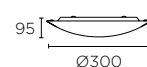

21

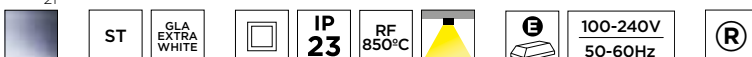

ROUND

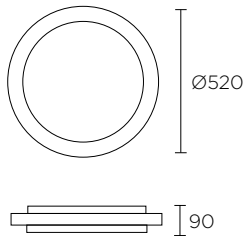

514-GR



T5 Tubular 22W
T5 Tubular 55W
Fluo, Led
A**... C



AUDREY

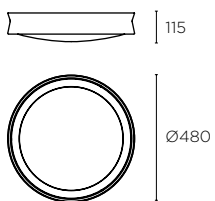

15-4336-14-M1



3xE-27 max. 25W
max. L 200 mm Ø 60 mm
Hal, Fluo, Led
A**... C



CHERRY

NEW

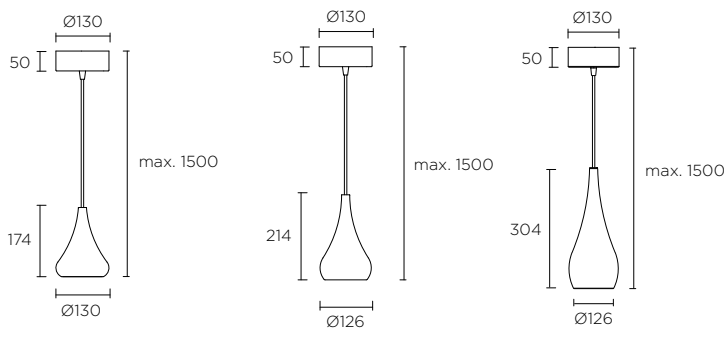

00-5346-F5-F5



00-5348-14-14



00-5350-34-34



Led **CREE** 12,6W
3000 K | 1290 lm
A+... A

F5 14 34
ST
PMMA TRANS
IP 20
100-240V 50-60Hz
100-240V 50-60Hz
®

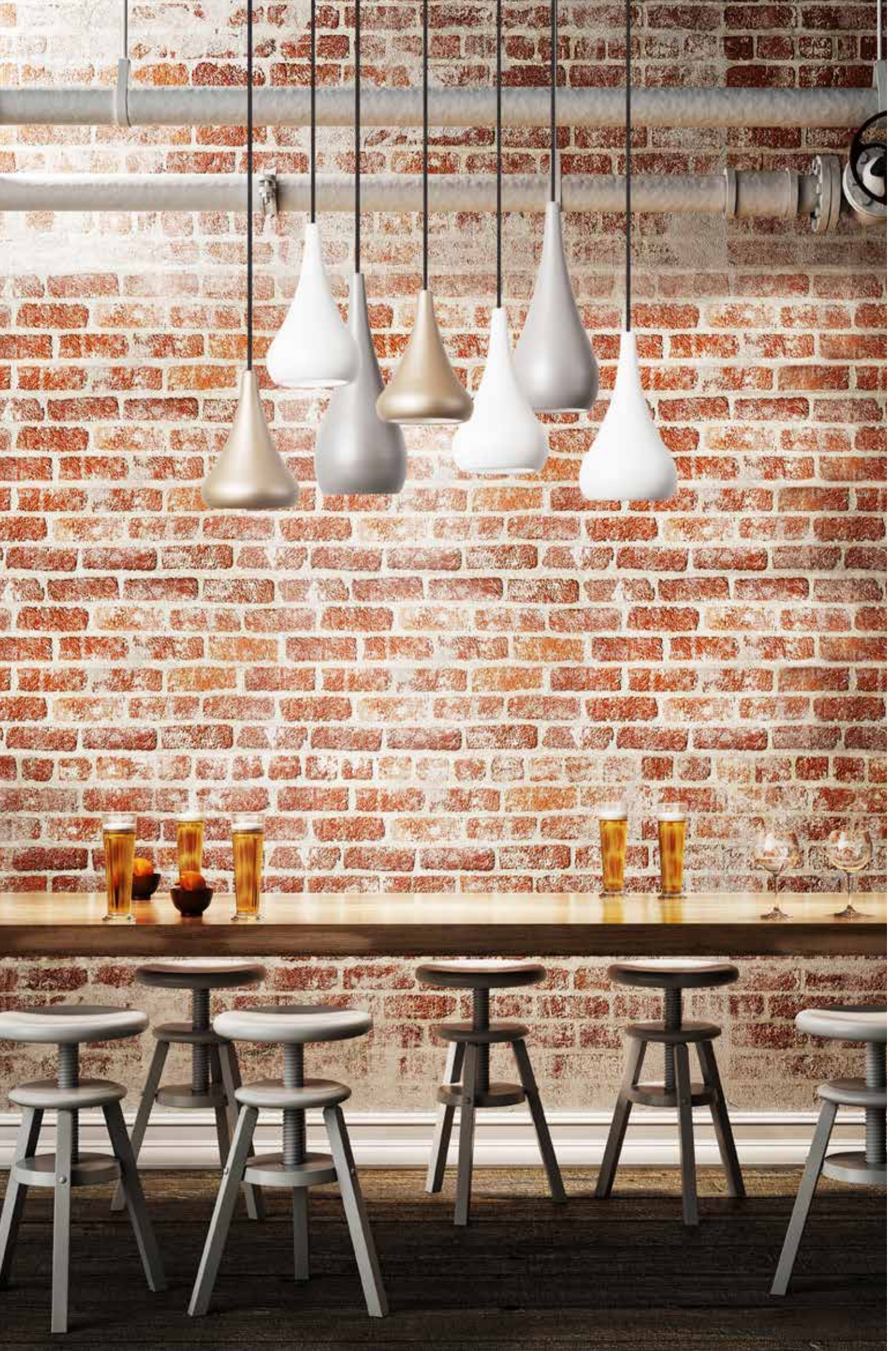

COLOR

NEW

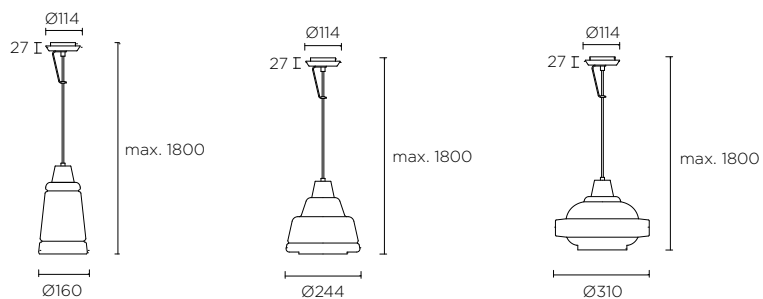

00-5434-60-11



00-5435-60-13



00-5436-60-24



1xE27 max. 60W | max. L 200 mm Ø 90 mm
Hal, Fluo, Led
A**... C



P. 77

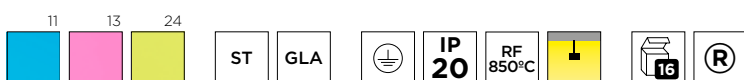

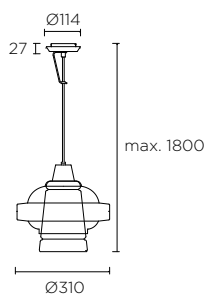
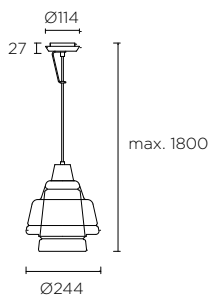

00-5437-60-E7



00-5438-60-E7



1xE27 max. 60W | max. L 200 mm Ø 90 mm
Hal, Fluo, Led
A**... C



P. 77

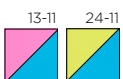

COLOR

NEW

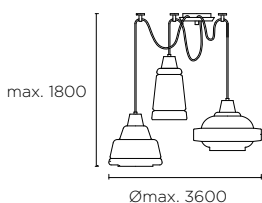

00-5441-60-E7

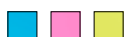

3xE27 max. 60W | max. L 200 mm Ø 90 mm
Hal, Fluo, Led
A**... C

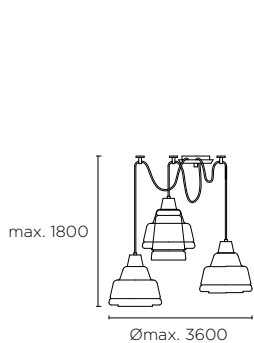

00-5442-60-E7



3xE27 max. 60W | max. L 200 mm Ø 90 mm
Hal, Fluo, Led
A**... C

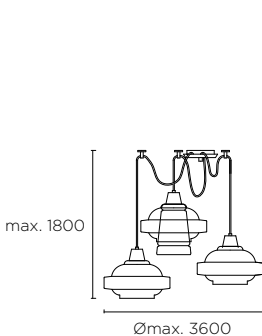

00-5443-60-E7



3xE27 max. 60W | max. L 200 mm Ø 90 mm
Hal, Fluo, Led
A**... C

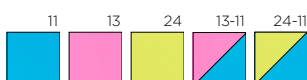

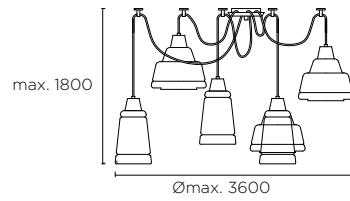

00-5439-60-E7

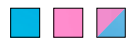

5xE27 max. 60W | max. L 200 mm Ø 90 mm
Hal, Fluo, Led
A**... C

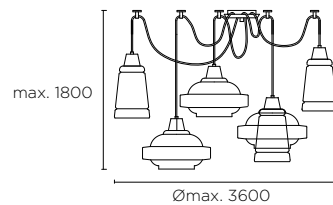

00-5440-60-E7



5xE27 max. 60W | max. L 200 mm Ø 90 mm
Hal, Fluo, Led
A**... C



KHOI

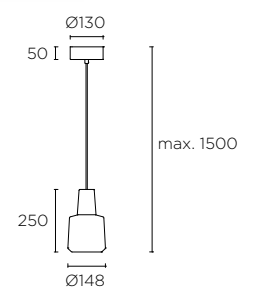
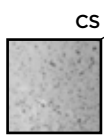

00-4037-CS-12



Led **CREE** 19,5W
3000 K | 1550 lm
A++ ... A

00-4037-14-37



CS 14

		AL	GLA DIF		RF 850°C				100-240V 50-60Hz		
--	--	----	------------	--	-------------	--	--	--	---------------------	--	--

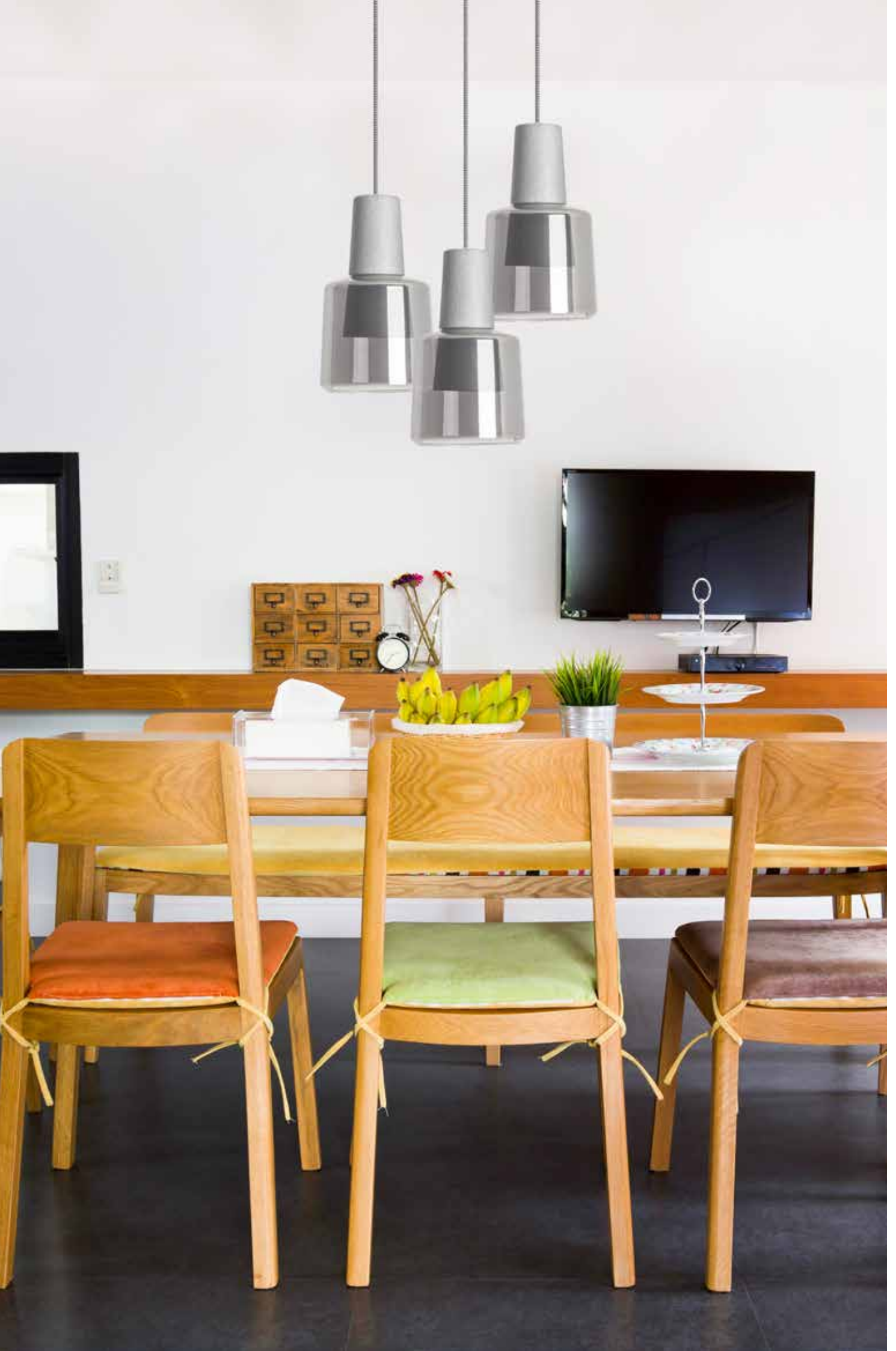

BELL

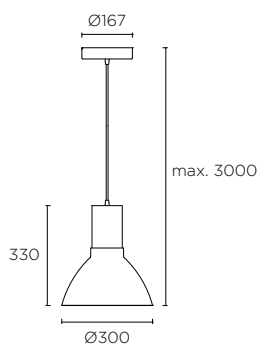

00-3219-S2-M2



Led **SHARP** 18W
3000 K | 1800 lm
A... A**





DECORATIVE | PENDANTS

SVEN

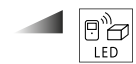
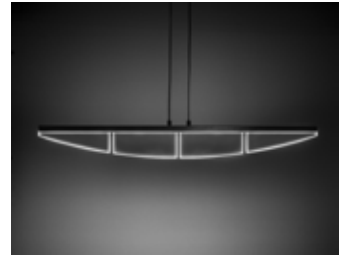

71-2241-00-00
P. 699

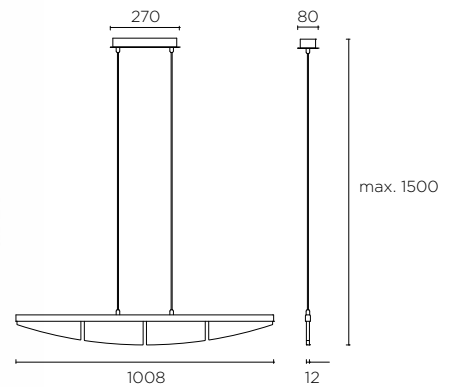

00-3272-S2-37



Led 29W
3000 K | 2520 lm
A**... A

S2

	AL	GLA DIF					100-240V 50-60Hz		
--	----	------------	--	--	--	--	---------------------	--	--

ROCKET

6 aros de colores incluidos
 6 coloured rings included
 6 anneaux de couleur fournis
 6 farbige Ringe inklusive
 6 anelli colorati inclusi
 6 aros coloridos incluidos
 В комплект входят 6 цветных колец
 Zawartych 6 kolorowych obręczy

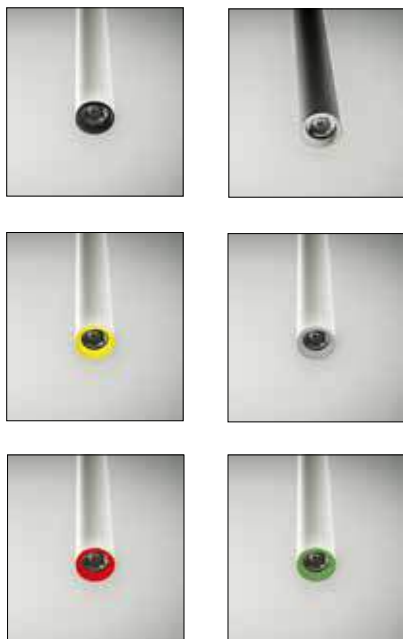

Producto personalizado bajo pedido
 Custom available products upon request
 Produits personnalisés sur commande
 Sonderanfertigungen auf Anfrage
 Prodotti personalizzabili su richiesta
 Produtos personalizados sob encomenda
 Продукция, изготовленная на заказ
 Indywidualizowane produkty dostępne na zamówienie

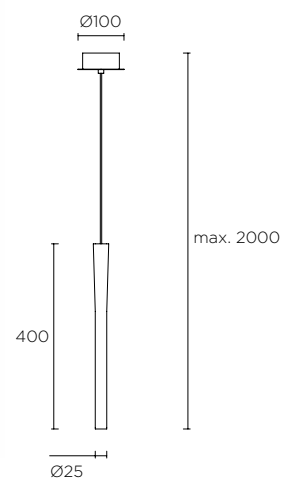

00-3279-16-16



Led **CREE** 2,2W
 3000 K | 162 lm
A... A**

00-3279-05-05



DECORATIVE | PENDANTS

ROCKET

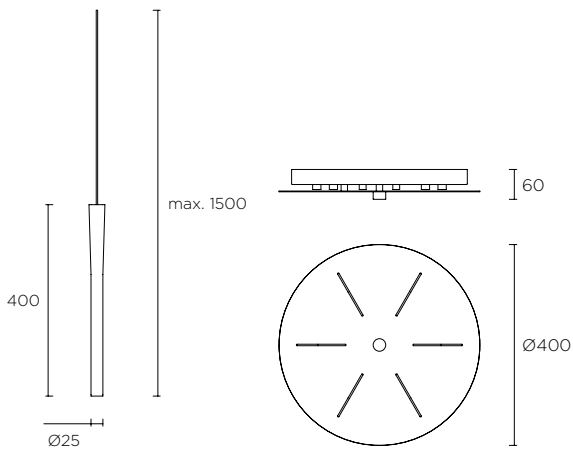

00-3280-05-16



Led **CREE** 2,2W
3000 K | 972 lm
A... A**

00-3280-16-16



00-3280-05-05



Producto personalizado bajo pedido
Custom available products upon request
Produits personnalisés sur commande
Sonderanfertigungen auf Anfrage
Prodotti personalizzabili su richiesta
Produtos personalizados sob encomenda
Продукция, изготовленная на заказ
Zindywidualizowane produkty dostępne na zamówienie



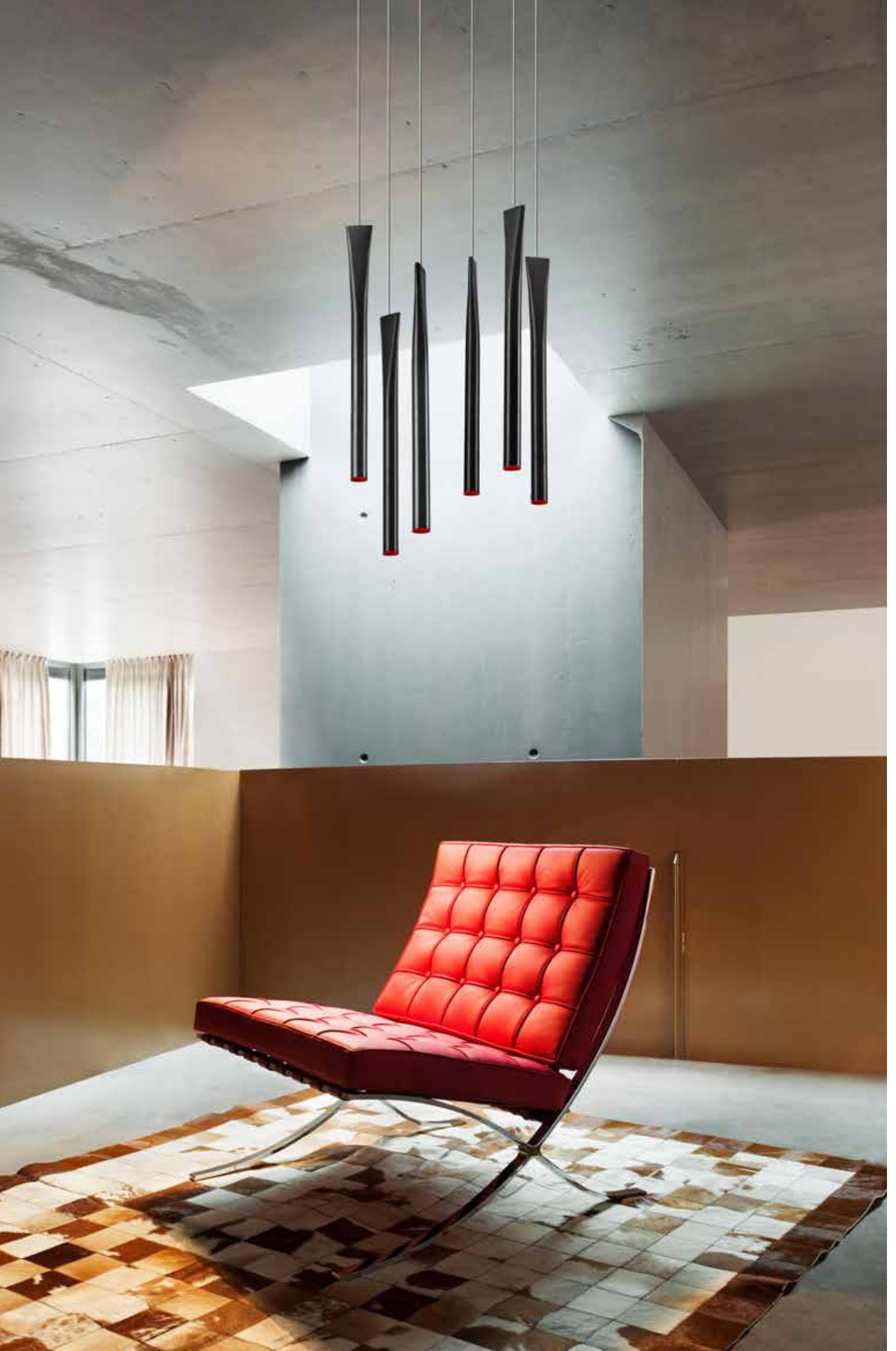

DECORATIVE | PENDANTS

DROP

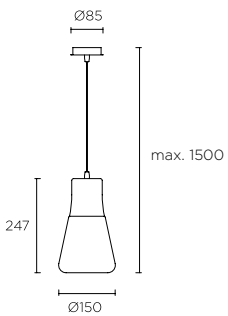

00-2018-21-F9



00-2018-14-F9



E-27 max. 60W | max. L 119 mm Ø 58 mm

RECOMMENDED LED ACT-FLL-050

Hal, Fluo, Led

A**... C



P. 77



NIMES

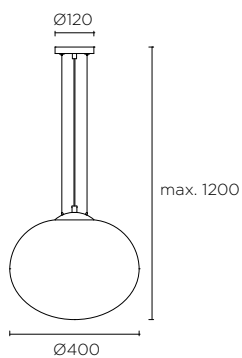

00-1640-81-F9



E-27 max. 100W | max. L 230 mm Ø 90 mm
Hal, Fluo, Led
A**... C



DECORATIVE | PENDANTS

81



DREAM

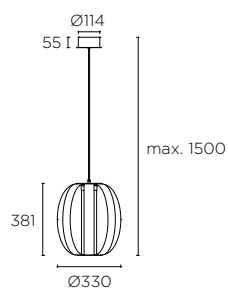
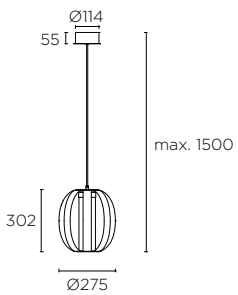
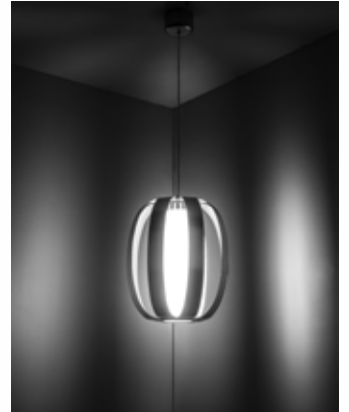

00-4929-94-M1



Led 8,2W
3000 K | 1200 lm

00-4930-94-M1



Led 16,2W
3000 K | 2020 lm





SUGAR

NEW

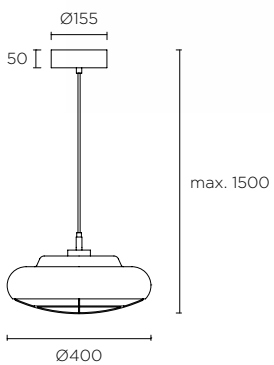

00-5297-14-23



00-5297-Z5-23



Led **CREE** 26,6W
2700 K | 2700 lm
A**... A

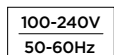
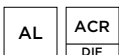
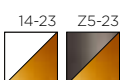



VINTAGE

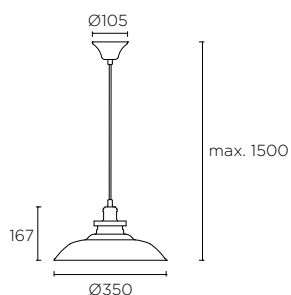

00-4850-E4-37



00-4850-E4-15



00-4851-E4-19



E27 max. 100W | max. L 130 mm Ø 75 mm

RECOMMENDED GLOBE 20W

Hal, Fluo, Led

A**... C



P. 77

E4 - 37 E4 - 15 E4 - 19





VINTAGE

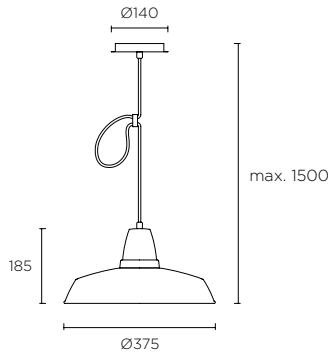

00-1799-S4-CG



00-1799-21-16



E27 max. 100W | max. L 140 mm Ø 80 mm

RECOMMENDED GLOBE 20W

Hal, Fluo, Led

A**... C



P. 77

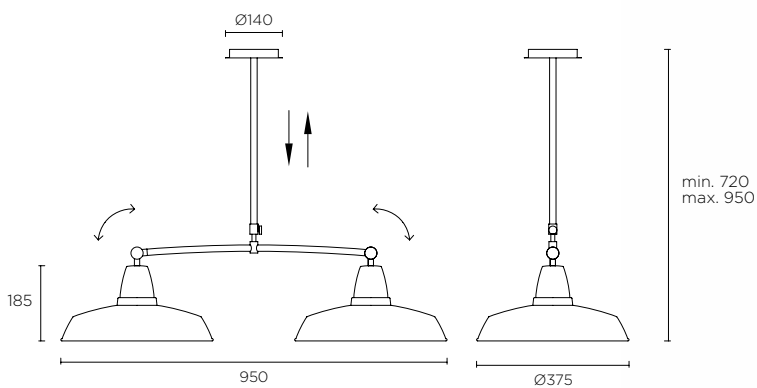

00-2011-S4-CG



00-2011-21-16



2xE27 max. 100W | max. L 140 mm Ø 80 mm

RECOMMENDED GLOBE 20W

Hal, Fluo, Led

A**... C



Z6 - 20 16 - 11





tradició



DECORATIVE | PENDANTS

RESTAURANT TOMAS TRADICIÓN - PALÀ DE TORRUELLA (BARCELONA)
MONINTERIORISME - MONTSE JIMÉNEZ

BUCKET

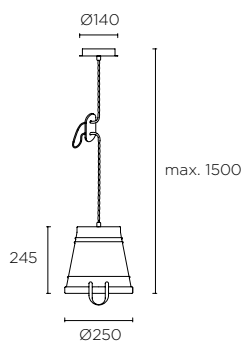

00-2708-16-11

00-2708-CG-16



E27 max. 100W | max. L 210 mm Ø 180 mm

RECOMMENDED GLOBE 18W

Hal, Fluo, Led

A**... C



P. 77

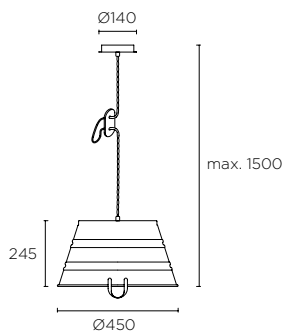

00-2709-16-11

00-2709-CG-16



E27 max. 100W | max. L 210 mm Ø 280 mm

RECOMMENDED GLOBE 18W

Hal, Fluo, Led

A**... C

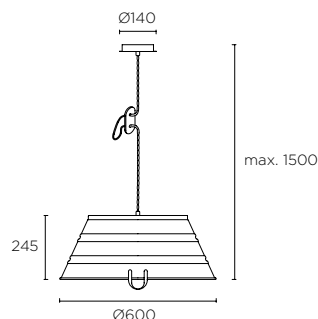

00-2710-16-11

00-2710-CG-16



3xE27 max. 60W | max. L 170 mm Ø 140 mm

Hal, Fluo, Led

A**... C



16 - 11 CG - 16





NEO



P. 77

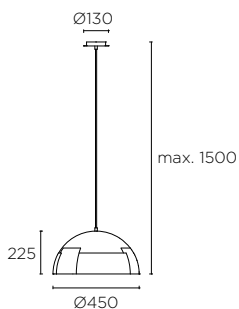

00-2749-E2-16

00-2749-T4-11



E27 max. 100W | max. L 190 mm Ø 240 mm

RECOMMENDED GLOBE 18W

Hal, Fluo, Led

A**... C

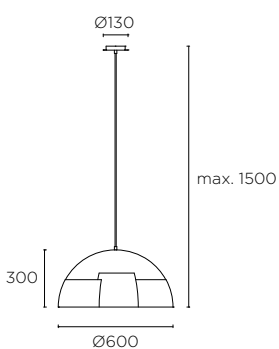

00-2908-E2-16

00-2908-T4-11



3xE27 max. 60W | max. L 170 mm Ø 140 mm

Hal, Fluo, Led

A**... C



E2 - 16 T4 - 11

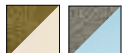

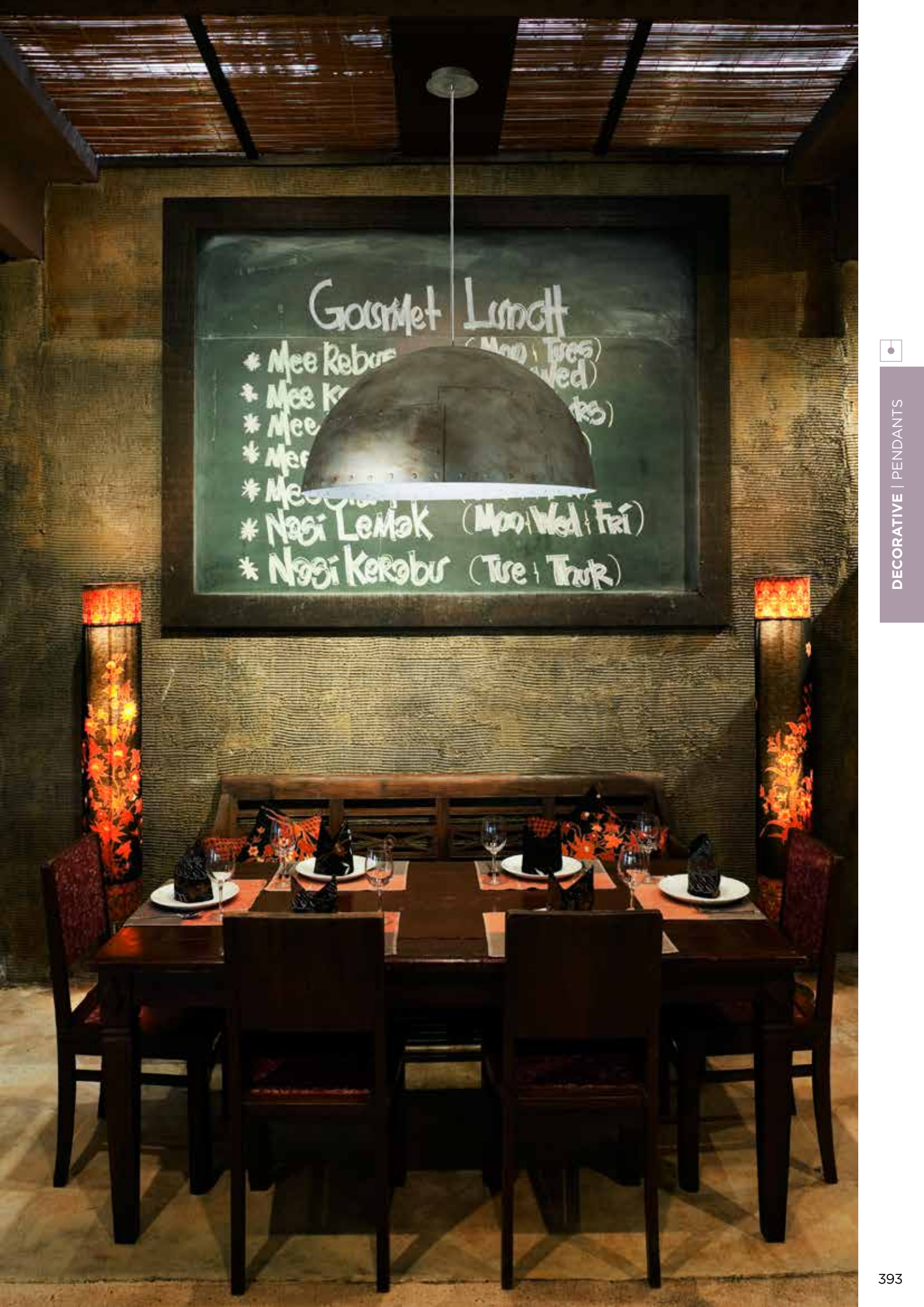

Gourmet Lunch

- * Mee Rebus (Mon, Tues)
- * Mee K... (Wed)
- * Mee ... (Thurs)
- * Mee ...
- * Mee ...
- * Nasi Lemak (Mon, Wed, Fri)
- * Nasi Kerabu (Tue, Thurs)



DECORATIVE | PENDANTS

MECANO

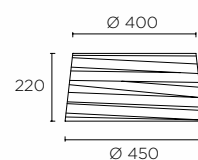
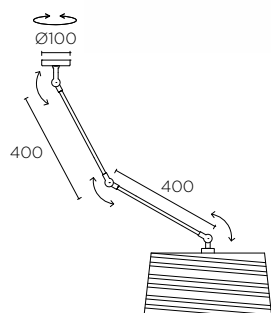

PAN-164-14 L 220 mm Ø 370 mm
PAN-164-05 L 220 mm Ø 370 mm

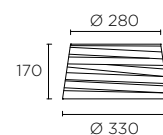

PAN-163-14 L 170 mm Ø 250 mm
PAN-163-05 L 170 mm Ø 250 mm

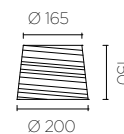

PAN-219-14 L 140 mm Ø 135 mm
PAN-219-05 L 140 mm Ø 135 mm

05-2707-81-21 + PAN



E27 max. 100W

RECOMMENDED GLOBE 18W

Hal, Fluo, Led

A++... C

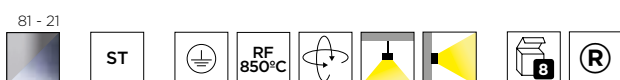



DECORATIVE | PENDANTS

05-2707-81-21 + PAN 219-05

UP & DOWN

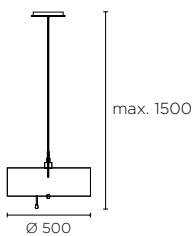

Light UP

Light DOWN



P. 77

00-2713-81-AJ



E27 HALOGEN max. 150W OSRAM INCLUDED | max. L 145 mm Ø 65 mm
RECOMMENDED MEGAMAN MU123i
Fluo, Led
A**... C



CUMBIA



DECORATIVE | PENDANTS

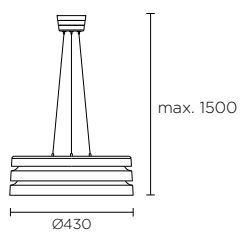

00-2785-21-AS



3xE-27 PL Elec. max. 20W | max. L 120 mm Ø 55 mm
Fluo, Led
A++... C

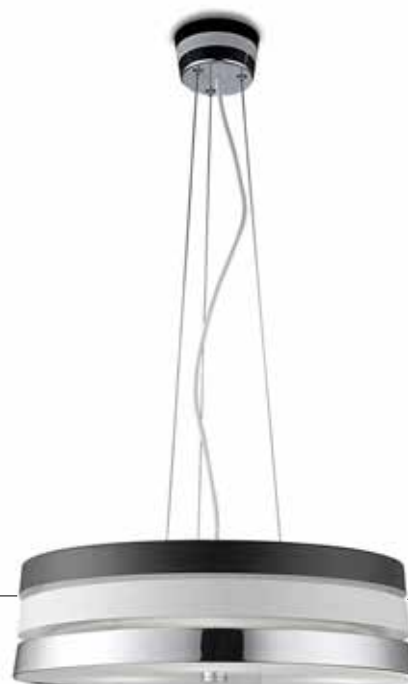

NEXT

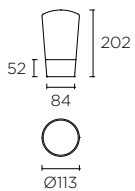

10-4757-06-F9



10-4757-81-F9



Led **CREE** 6,9W
3000 K | 550 lm
A**... C

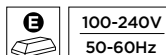
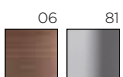

ELVA

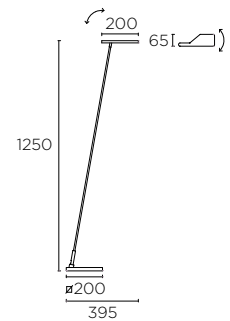

25-1523-21-21



Led **CITIZEN** 6W
3000 K | 434 lm
A**... A



DECORATIVE | DESK & FLOOR



10-1523-21-21



Led **CITIZEN** 6W
3000 K | 434 lm
A**... A

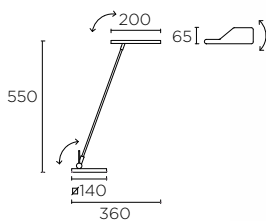

21



100-240V
50-60Hz



FLEX

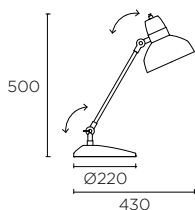

10-1530-21-14



10-1530-21-05



E27 max. 60W | max. L 130 mm Ø 70 mm
Hal, Fluo, Led
RECOMMENDED MINI GLOBE 11W 
A**... C

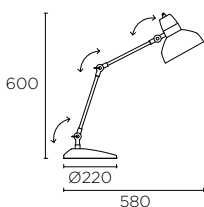

10-1531-21-14



10-1531-21-05



E27 max. 60W | max. L 130 mm Ø 70 mm
Hal, Fluo, Led
RECOMMENDED MINI GLOBE 11W 
A**... C





QUEEN

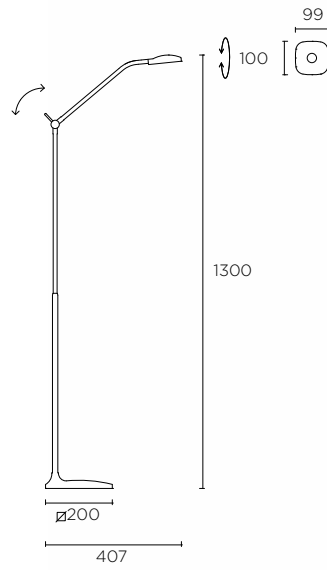

25-3273-21-05



25-3273-E4-Y2



Led **CREE** 6,9W
3000 K | 550 lm
A**... A



10-3273-21-05



Led **CREE** 6,9W
3000 K | 550 lm
A**... A

10-3273-E4-Y2

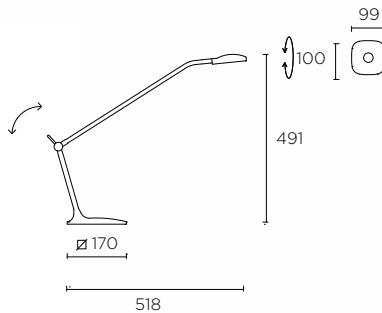

21-05 E4-Y2



100-240V
50-60Hz



P. 308

P. 404



QUEEN

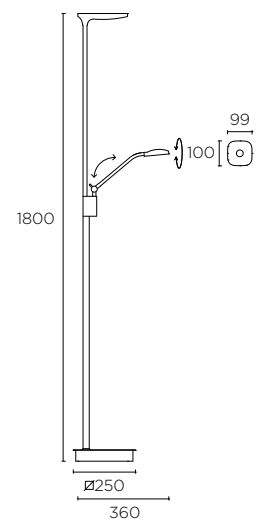

25-4760-21-05



Led **CREE** 25,9W
3000 K | 2700 lm
Led **CREE** 6,9W
3000 K | 550 lm
A++... A

21-05

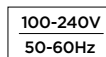

P. 308 P. 402

P. 402

MEMPHIS



248-NS



1 X R7S L 118 max. 300W
1 X GY 6,35 50W 12V

INCLUDED

A**... C



DECORATIVE | DESK & FLOOR

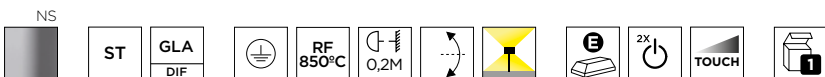

CRETA

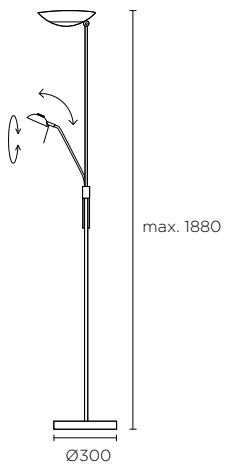

127-NS



R7S L 118 max. 300W
GY 6,35 50W 12V

INCLUDED
A**... C

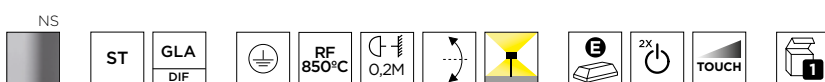

PING



DECORATIVE | DESK & FLOOR

25-3215-14-M1



2xE27 pl elec. max. 18W | max. Ø 60 mm L 130 mm

Fluo, Led

Led **CREE** 2,2W

3000 K | 182 lm

A... C A**... A**

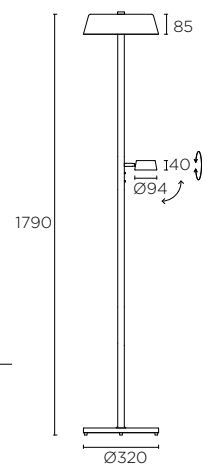

14

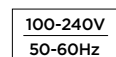

JAZZ

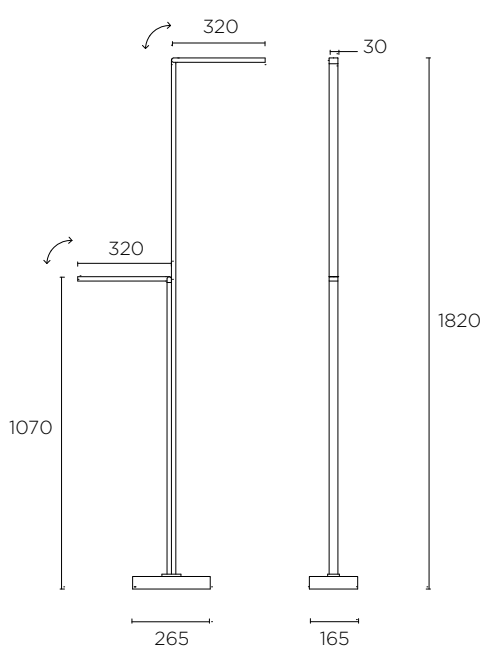

25-3216-14-M3



Led **CREE** 19,8W
3000 K | 1540 lm
Led **CREE** 2,2W
3000 K | 162 lm
A++... A

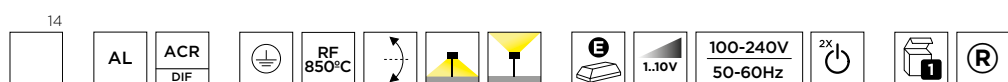



DECORATIVE | DESK & FLOOR

ABERDEEN

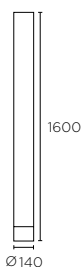

337-AL



E27 par 30 max. 75W | max. L 1500 mm Ø 120 mm
Hal, Fluo, Led
A... C**



EXTEND

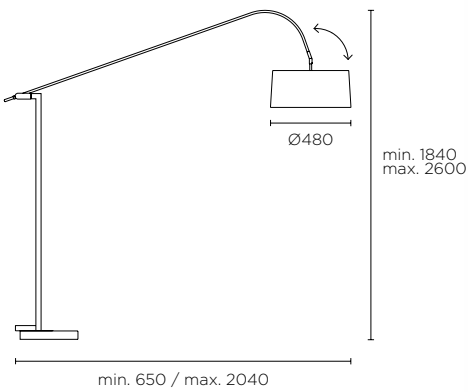

25-2860-Y2-05V1



3xE27 max. 60W | max. L 120 mm Ø 90 mm
Hal, Fluo, Led
A++... C

25-2860-Y2-14V1



DECORATIVE | DESK & FLOOR

Y2 - 21 PAN 05 PAN 14





BATHROOM LIGHTING

LA ILUMINACIÓN EN LA ZONA DE BAÑO | BATHROOM LIGHTING | L'ÉCLAIRAGE DANS LA SALLE DE BAINS | BELEUCHTUNG IM BAD | L'ILLUMINAZIONE NELL'AREA DEL BAGNO | ILUMINAÇÃO DA CASA DE BANHO | ОСВЕЩЕНИЕ БАНИХ КОМНАТ | OŚWIETLENIE ŁAZIENKOWE



DECORATIVE | BATH

ZONA 1 Protección contra posibles penetraciones de agua. Se requiere IP45 (IPX5) o superior.

ZONA 2 Protección contra posibles proyecciones de agua. Se requiere IP44 (IPX4) o superior.

ZONA 3 Sin restricciones en esta zona.

ZONE 1 Protection against direct water jets. IP45 (IPX5) or above required.

ZONE 2 Protection from water splashing. IP44 (IPX4) or above required.

ZONE 3 No-restriction zone.

ZONE 1 Protection contre le risque de pénétration d'eau. Indice IP45 (IPX5) ou supérieur exigé.

ZONE 2 Protection contre le risque de projection d'eau. Indice IP44 (IPX4) ou supérieur exigé.

ZONE 3 Aucune restriction dans cette zone.

ZONE 1 Schutz gegen Wassereintritt. Schutzklasse IP45 (IPX5) oder höher erforderlich.

ZONE 2 Schutz gegen Wasserspritzer. Schutzklasse IP44 (IPX4) oder höher erforderlich.

ZONE 3 Zone ohne Beschränkungen

ZONA 1 Protezione da possibili infiltrazioni d'acqua. Necessario IP45 (IPX5) o superiore.

ZONA 2 Protezione da possibili schizzi d'acqua. Necessario IP44 (IPX4) o superiore.

ZONA 3 Nessuna limitazione in questa zona.

ZONA 1 Proteção contra possíveis penetrações de água. Requer IP45 (IPX5) ou superior.

ZONA 2 Proteção contra possíveis projeções de água. Requer IP44 (IPX4) ou superior.

ZONA 3 Sem restrições nesta zona.

ЗОНА 1 Защита от возможного попадания воды. Обладает IP45 (IPX5) или выше.

ЗОНА 2 Защита от возможного попадания воды. Обладает IP44 (IPX4) или выше.

ЗОНА 3 Без ограничения на данной территории.

STREFA 1 Ochrona przed penetracją wody. Wymagane IP45 (IPX5) lub wyższe.

STREFA 2 Ochrona przed rozpryskiem wody. Wymagane IP44 (IPX4) lub wyższe.

STREFA 3 Brak wymagań IP.

SPLASH NEW

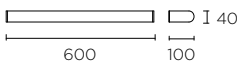

05-5308-21-M1



Led **SAMSUNG** 12,7W Down + 8,6W Up
3000 K | 1595 lm Down + 1065 lm Up
A**... A

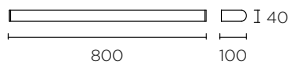

05-5309-21-M1



Led **SAMSUNG** 19W Down + 8,6W Up
3000 K | 2385 lm Down + 1065 lm Up
A**... A





CONCEPT

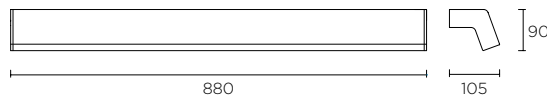
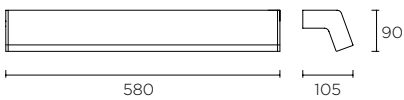

05-4699-21-M1



2xT5 14W
A**... C

05-4700-21-M1



2xT5 21W
A**... C

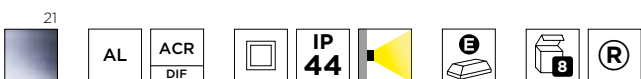

BELYSA



DECORATIVE | BATH



IP44

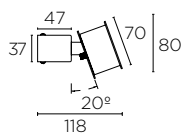

IP20

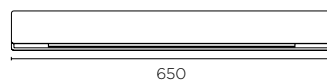
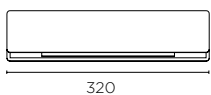
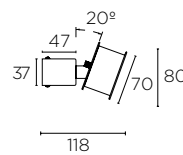

05-4361-21-05



2G11 18W
A**... C

05-4362-21-05



2G11 40W
A**... C

21



MAKE UP

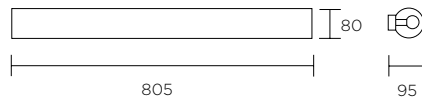
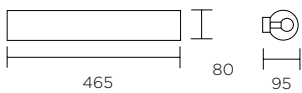

488-AL



3xG9 max. 60W
40W OSRAM INCLUDED
A**... C

489-AL



5xG9 max. 60W
40W OSRAM INCLUDED
A**... C



SKARA



DECORATIVE | BATH

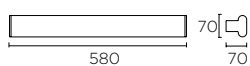

05-4357-21-M1



T5 14W
A**... C

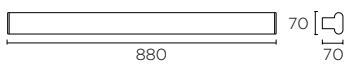

05-4358-21-M1



T5 21W
A**... C

21



TOILET

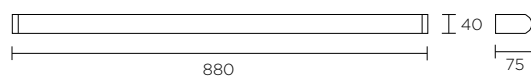
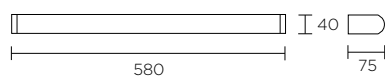
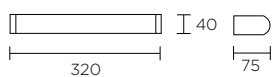

05-4376-21-M1



T5 8W
A**... C

05-4375-21-M1



T5 14W
A**... C

05-4374-21-M1



T5 21W
A**... C

05-2325-21-M1



T5 HO 24W
A**... C

05-2326-21-M1



T5 HO 39W
A**... C

21



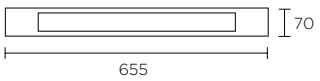

457-CR



2G11 24W
A**... C



21



TOILET Q

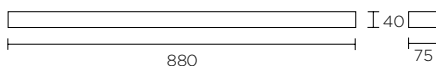
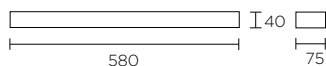

05-2327-21-M1



T5 HO 24W
A**... C

05-2328-21-M1



T5 HO 39W
A**... C

05-4377-21-M1



T5 14W
A**... C

05-4378-21-M1



T5 21W
A**... C

05-1507-21-M1

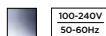

Led 10W
3000 K | 910 lm
A**... A

05-1508-21-M1



Led 16W
3000 K | 1405 lm
A**... A

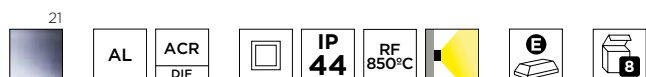



DRESDE

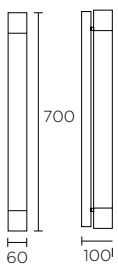

05-4387-21-M1



2G11 40W
A**... C

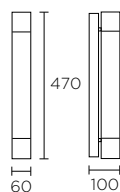

05-4386-21-M1



2G11 24W
A**... C

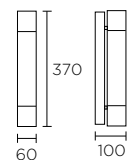

05-4385-21-M1



2G11 18W
A**... C

21



DRESDE EVO

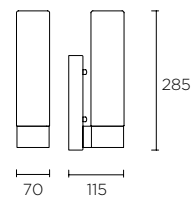
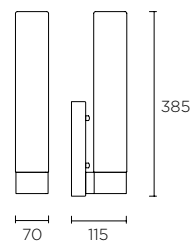
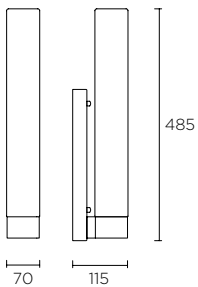

05-0028-21-F9



2G11 36W
A**... C

05-0027-21-F9



2G11 24W
A**... C

05-0026-21-F9



2G11 18W
A**... C



DECORATIVE | BATH

21



DRESDE ON

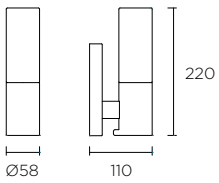

05-1411-21-F9



E14 max. 40W | max. Ø 50 mm L 110 mm
Fluo, Led
A**... C

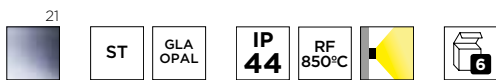

BATH

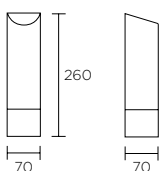

05-4379-81-F9



E27 pl elec. max. 20W | max. Ø 60 mm L 170 mm
Hal, Fluo, Led
A**... C

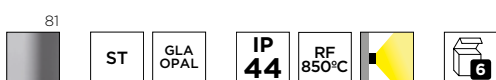

ORION

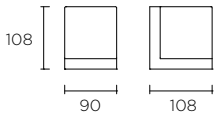

05-1389-21-F9



G9 max. 40W
A**... C

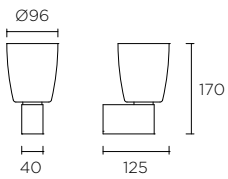

05-1383-21-F9



E14 max. 40W | max. Ø 110 mm L 50 mm
Hal, Fluo, Led
A**... C

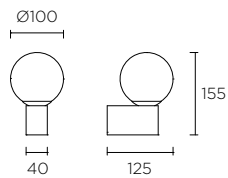

05-1410-21-F9

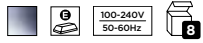

Led **CREE** 4W
3000 K | 324 lm
A**... A

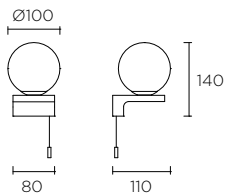

05-1380-21-F9



G9 max. 40W
A**... C



DECORATIVE | BATH



ONDA

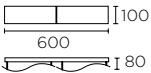

486-BL



2xG9 max. 75W **OSRAM INCLUDED**
A... C**

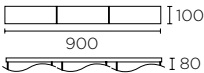

487-BL



3xG9 max. 75W **OSRAM INCLUDED**
A... C**



BL

	AL	GLA DIF		IP 44	RF 850°C			
--	----	------------	--	----------	-------------	--	--	--

LORIENT



DECORATIVE | BATH

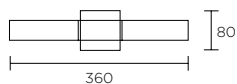

05-4373-21-F9



2xG9 max. 40W **OSRAM INCLUDED**
A**... C



21



BUBBLE

NEW

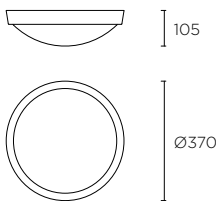

15-5299-21-M1



Led **SAMSUNG** 19W
3000 K | 2620 lm
A++... A

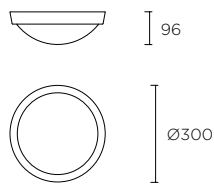

15-5298-21-M1



Led **SAMSUNG** 12,5W
3000 K | 1750 lm
A++... A

21

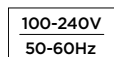



FLOW



05-3213-21-B4



2xE27 max. 46W | max. L 130 mm Ø 85 mm
Hal, Fluo, Led
A**... C

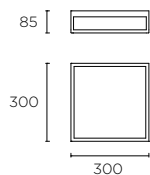

15-3213-21-B4



3xE27 pl elec max. 18W | max. L 130 mm Ø 85 mm
Hal, Fluo, Led
A**... C

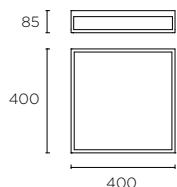

15-3214-21-B4



3xE27 pl elec max. 20W | max. L 150 mm Ø= 60 mm
Hal, Fluo, Led
A**... C

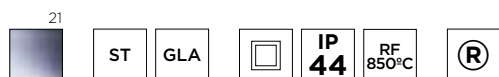



DEC

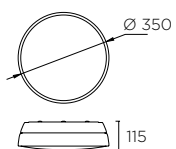
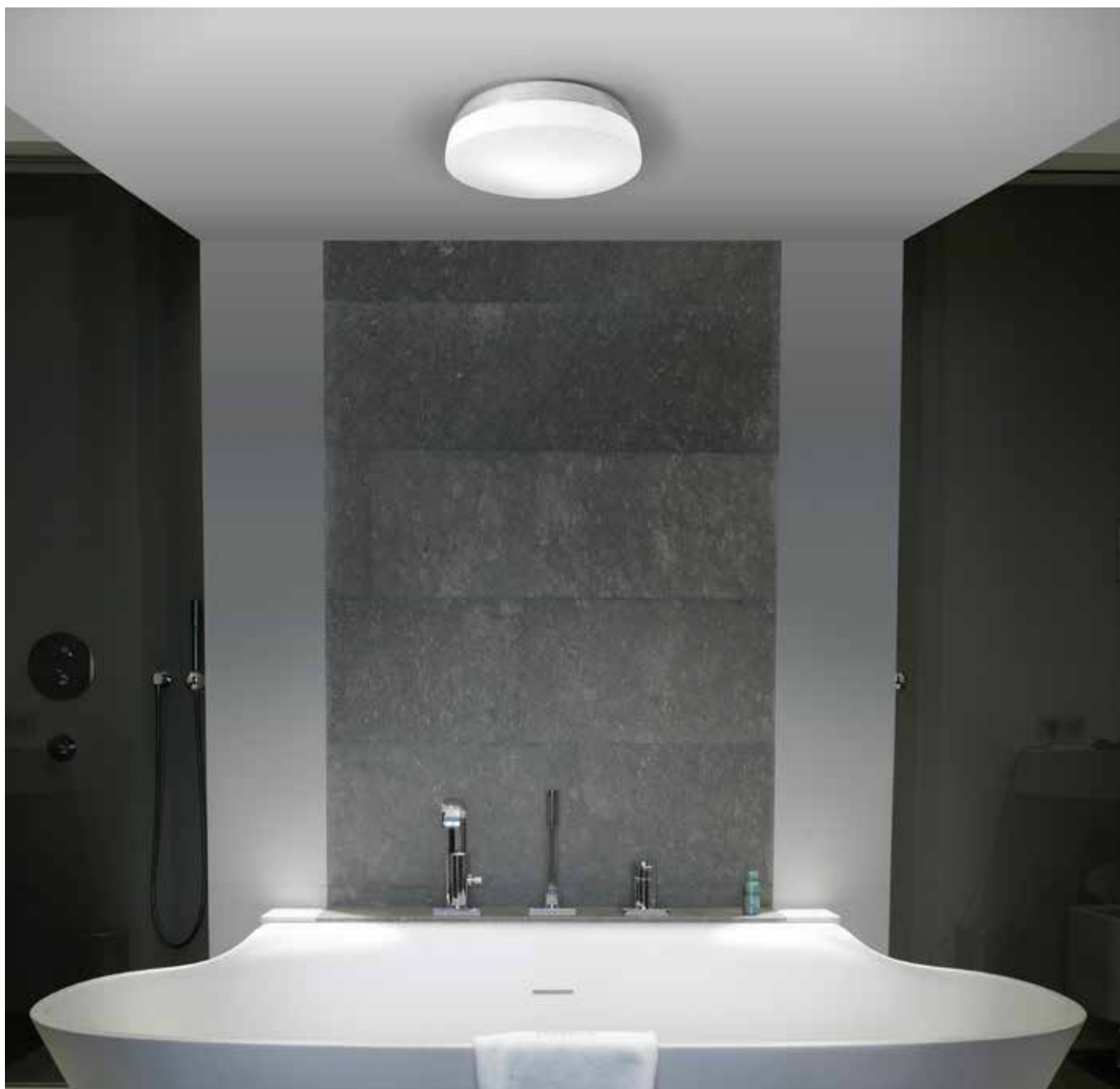

15-4370-21-F9



2xE27 pl elec. max. 40W | max. L 160 mm Ø 60 mm
Hal, Fluo, Led
A**... C

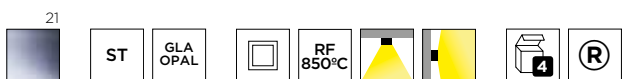

PARMA



DECORATIVE | BATH

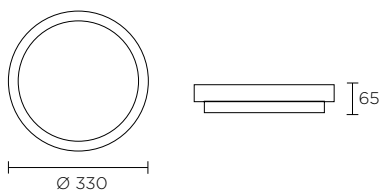

15-1733-81-F9V1



2xG24d2 18W
A**... C



BOB

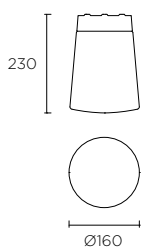

15-2514-21-F9



E27 pl elec max. 42W | max. L 170 mm Ø 130 mm
Hal, Fluo, Led
A**... C







P.83

EIS

71-4396-00-00
(Kit GU10)

90-1689-21-37



GU5.3 max. 50W
Hal, Led
RECOMMENDED ACT-FLL-021
A**... C

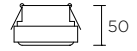

90-1690-21-37



GU5.3 max. 50W
Hal, Led
RECOMMENDED ACT-FLL-021
A**... C

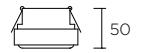

90-1792-21-37



GU5.3 max. 50W
Hal, Led
RECOMMENDED ACT-FLL-021
A**... C

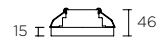
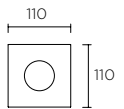

90-1789-21-37



GU5.3 max. 50W
Hal, Led
RECOMMENDED ACT-FLL-021
A**... C

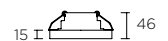

21



P. 691





DECORATIVE | BATH



P.83

SPLIT

71-4396-00-00
(Kit GU10)

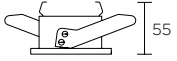

320-BL



GU5.3 max. 50W 12V
Hal, Led
A+... C

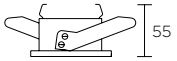

320-CR



GU5.3 max. 50W 12V
Hal, Led
A+... C

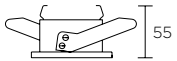

320-NS



GU5.3 max. 50W 12V
Hal, Led
A+... C





DECORATIVE | BATH



71-4396-00-00
(Kit GU10)

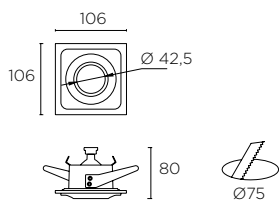

90-4349-14-B9



GU5.3 max. 50W 12V
Hal, Led
A**... C

14

AL	GLA DIF		IP 65		RF 850°C		P. 691		
----	------------	--	----------	--	-------------	--	--------	--	--

GLANZ



DECORATIVE | BATH

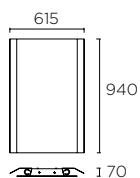

75-4371-K3-M1



2xT5 39W
A**... C



REFLEX

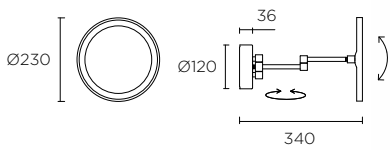

75-5314-21-K3



Led **SAMSUNG** 6W
3000 K | 1100 lm
A**... A

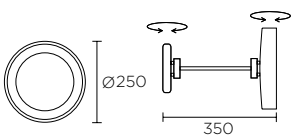
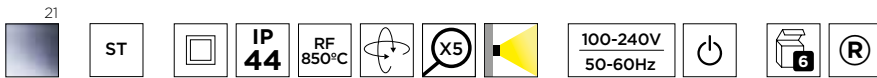

476-CR



T5 22W
A**... C

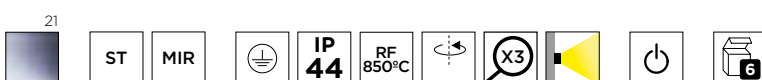



REFLEX

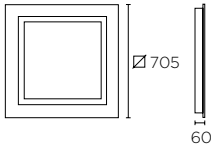

427-ES



4x2G11 40W
A**... C

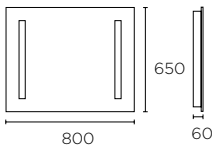

426-ES



2x2G11 55W
A**... C

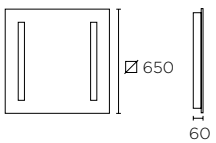

425-ES



2x2G11 55W
A**... C

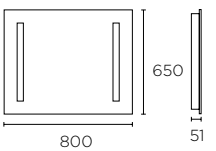

75-4858-K3-F1

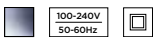

Led 38W
3000 K
A**... A



21



VANITY



DECORATIVE | BATH

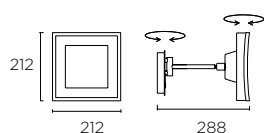

75-4366-21-K3



GX53 max. 9W

RECOMMENDED MEGAMAN 9W

A... C**

21



CHOOSE YOUR FAN

CÓMO ELEGIR SU VENTILADOR | HOW TO CHOOSE YOUR FAN | COMMENT CHOISIR VOTRE VENTILATEUR | AUSWAHL DES GEEIGNETEN VENTILATORS | COME SCEGLIERE IL SUO/LA SUA VENTILATORE DA SOFFITTO | COMO ESCOLHER O SEU VENTILADOR | КАК ВЫБРАТЬ ВЕНТИЛЯТОР | JAK WYBRAĆ WENTYLATOR

1

LUZ | LIGHT | LUMIÈRE | LICHT | LUCE | LUZ | CBET | ŚWIATŁO

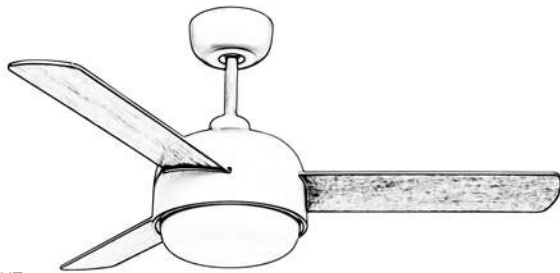

CON LUZ
WITH LIGHT
AVEC LUMIÈRE
MIT LICHT
CON LUCE
COM LUZ
CO CBETOM
ZE ŚWIATŁEM

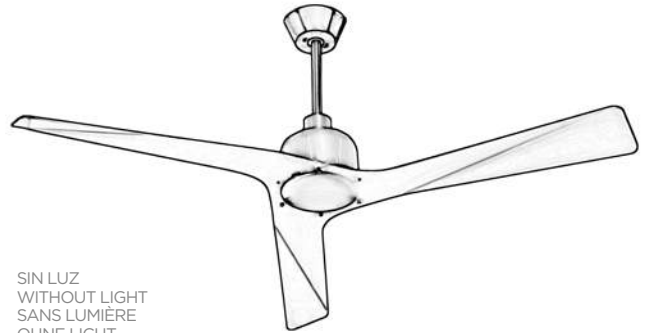

SIN LUZ
WITHOUT LIGHT
SANS LUMIÈRE
OHNE LICHT
SENZA LUCE
SEM LUZ
БЕЗ CBETA
BEZ ŚWIATŁA



2

MEDIDA | SIZE | DIMENSION | GRÖSSE | DIMENSIONE | DIMENSÃO | РАЗМЕРЫ | ROZMIAR



< 15 M²

< 1000 mm

S



15 M² - 20 M²

>1000 mm
< 1320 mm

M

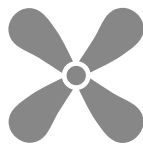

> 20 M²

> 1320 mm

L

S

PEQUEÑA
SMALL
PETITE
KLEIN
PICCOLA
PEQUENO
МАЛЕНЬКИЙ
MAŁY

M

MEDIANA
MEDIUM
MOYENNE
MITTEL
MEDIA
MÉDIO
СРЕДНИЙ
ŚREDNI

L

GRANDE
LARGE
GRANDE
GROSS
MITTEL
GRANDE
GRANDE
БОЛЬШОЙ
DUŻY

3

DISEÑO | DESIGN | DESIGN | DESIGN | DESENHO | DESIGN | ДИЗАЙН | WZÓR

S PEQUEÑO | SMALL | PETITE | KLEIN | PICCOLA | PEQUENO | МАЛЕНЬКИЙ | MAŁY



BOUVET 484

M MEDIANO | MEDIUM | MOYENNE | MITTEL | MEDIO | MÉDIO | СРЕДНИЙ | ŚREDNI



BORNEO 470 - 471

DOMINICA 485

KLAR 460 - 461

TUPAI DC 488 - 489

L GRANDE | LARGE | GRANDE | GROSS | GRANDE | GRANDE | БОЛЬШОЙ | DUŻY



AUKENA 472 - 473

BAHIA 466 - 467

BELMONT 478 - 479

CEOS 458 - 459



FORMENTERA 468 - 469

FUS 464 - 465

GARBÍ 452 - 453

HAWAII 474 - 475



MOGAN 490 - 491

PHUKET 482 - 483

RODAS 492 - 493

SAMAL 476 - 477



STEM 486 - 487

TIGA 454 - 457

TORONTO 480 - 481

TUPAI DC 488 - 489

VINTAGE 462 - 463



DECORATIVE | CEILING FANS

VENTAJAS | ADVANTAGES | AVANTAGES | VORTEILE | VANTAGGI
VANTAGENS | ПРЕИМУЩЕСТВА | ZALETY

FUNCIÓN INVERSA | REVERSE FUNCTION | FONCTION INVERSE | INVERSE-FUNKTION | FUNZIONE INVERSA |
FUNÇÃO INVERSA | ОБРАТНАЯ ФУНКЦИЯ | ODWROTNA FUNKCJA

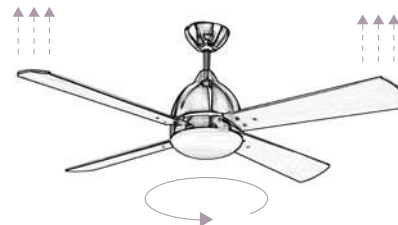
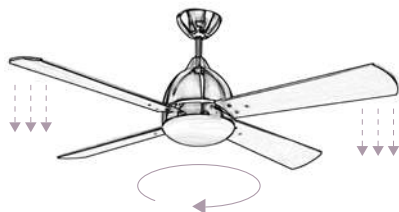

Úsalo todo el año
Use it all year round
Utilisez-le toute l'année
Sommer - und Winterbetrieb
Usalo tutto l'anno
Utilize-o todo o ano
Пользуйтесь им круглый год
Do Użytku Całorocznego

AHORRA Y PROTEGE | SAVE AND PROTECT | ÉCONOMISE ET PROTÈGE | SPAREN UND SCHÜTZEN |
RISPARMIA E RISPETTA L'AMBIENTE | ECONOMIZA E PROTEGE | ЭКОНОМИТ И ЗАЩИЩАЕТ | OSZCZĘDZA I ZABEZPIECZA

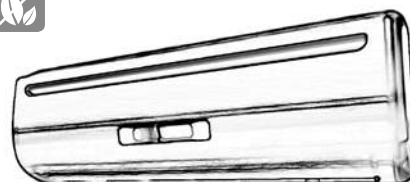

SILENCIOSO | SILENT | SILENCIEUX | GERÄUSCHARM | SILENZIOSO
SILENCIOSO | БЕСШУМНЫЙ | CICHY

GARANTÍA | GUARANTEE | GARANTIE | GARANTIE
GARANZIA | GARANTIA | ГАРАНТИЯ | GWARANCJA



INSTALACIÓN | INSTALLATION | INSTALLATION | MONTAGE | INSTALLAZIONE | INSTALAÇÃO
МОНТАЖ | INSTALACJA



Instalación en techos con pendiente máxima de 15°
To be installed on ceilings with 15° maximum pendant
Installation sur plafonds à inclinaison maximale de 15°
Deckenmontage mit max. Neigung von 15°
Ammette l'installazione su soffitti con una pendenza massima di 15 gradi
Instalação em tetos com inclinação máxima de 15°
Монтаж на потолках с максимальным углом наклона 15°
Instalacja w sufitach o maksymalnym nachyleniu 15°

CONSEJOS | ADVICES | CONSEILS | TIPPS
RACCOMANDAZIONI | CONSELHOS | COBETЫ | PORADY

ALTURA | HEIGHT | HAUTEUR | HÖHE | ALTEZZA | ALTURA
| ВЫСОТА | WYSOKOŚĆ

INSTALACIÓN | INSTALLATION | INSTALLATION | MONTAGE
| INSTALLAZIONE | INSTALAÇÃO | МОНТАЖ | INSTALACJA

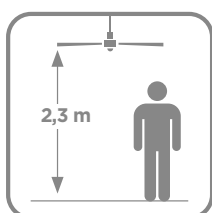
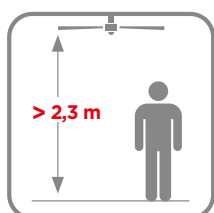
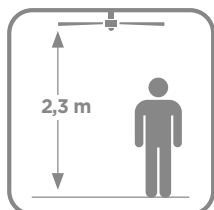

P. 791

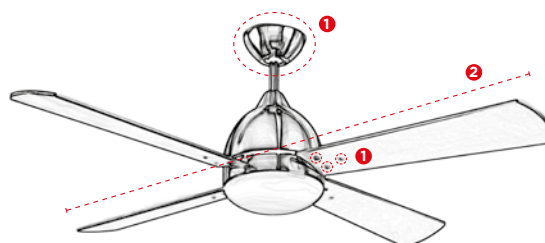

1 Fije correctamente el soporte y las palas

Fix the support and the blades correctly

2 Utilice los contrapesos en caso de balanceo

If it is unstable, please use the counterweights

3 Finalmente - tenga en cuenta que es necesario un período de 24h de asentamiento

Finally - please be aware that it is necessary to allow a 24-hour settling period



MOTOR DC | DC MOTOR

VENTAJAS | ADVANTAGES | AVANTAGES | VORTEILE | VANTAGGI
| VANTAGENS | ПРЕИМУЩЕСТВА | ZALETY



Más del 50% de ahorro energético
Over 50% Energy Saving
Plus de 50% d'économie d'énergie
Energieeinsparung um mehr als 50%
Oltre il 50% di risparmio energetico
Poupança energética superior a 50%
Энергосбережение свыше 50%
Ponad 50% oszczędności energetycznej



Mayor control de la velocidad
Higher speed control
Meilleur contrôle de vitesse
Bessere Geschwindigkeitssteuerung
Maggiore precisione nel controllo della velocità
Maior controle da velocidade
Большой контроль за скоростью
Większa kontrola szybkości



Mayor rapidez en los cambios
Quicker changes
Plus rapide dans les changements
Schnelles Auswechseln
Maggiore rapidità dei cambi
Maior rapidez nas substituições
Более быстрая смена скоростей
Większa szybkość podczas zmian



Mayor vida útil
Longer working life
Durée de vie utile allongée
Längere Lebensdauer
Maggiore vita utile
Maior vida útil
Большой срок использования
Dłuższy okres użytkowania



Más silencioso
More silent
Plus silencieux
Geräuscharm
Più silenzioso
Mais silencioso
Более бесшумная работа
Cichszy



Menor peso
Lighter weight
Moins lourd
Weniger Gewicht
Minor peso
Menor peso
Меньший вес
Mniejszy ciężar



DECORATIVE | CEILING FANS

GARBÍ

NEW

BY JORDI BLASI



30-5378-14-F9 ^{LED}



Led 11,4W
3000K | 1400 lm
A++... A

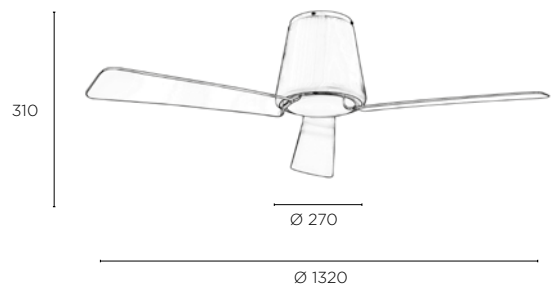

14

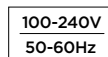



DECORATIVE | CEILING FANS

TIGA

BY ESTUDI RIBAUDÍ



Kit opcional
Optional Kit
Kit en option
Kit als Zubehör
Kit opzionale
Kit opcional
Набор по желанию
Zestaw opcjonalny



P. 456

30-3249-CF-M1 LED



Led 16,6W
3000K | 1800 lm
A**... A



Halo de luz
Halo light
Faisceau lumineux
Lichtbündel
Fascio di luce
Feixe de luz
Ореол света
Odblask światła

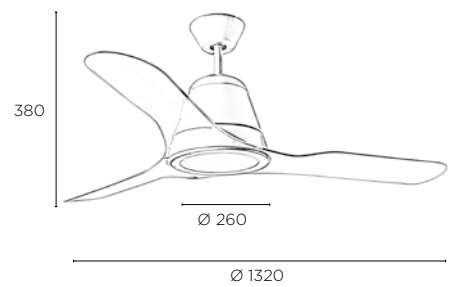



DECORATIVE | CEILING FANS

TIGA

BY ESTUDI RIBAUDÍ



30-3249-CF-M1
+
71-4867-11-11



30-3249-CF-M1
+
71-4867-13-13



30-3249-CF-M1
+
71-4867-24-24



30-3249-CF-M1
+
71-4867-CV-CV

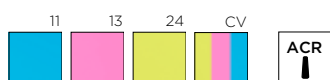

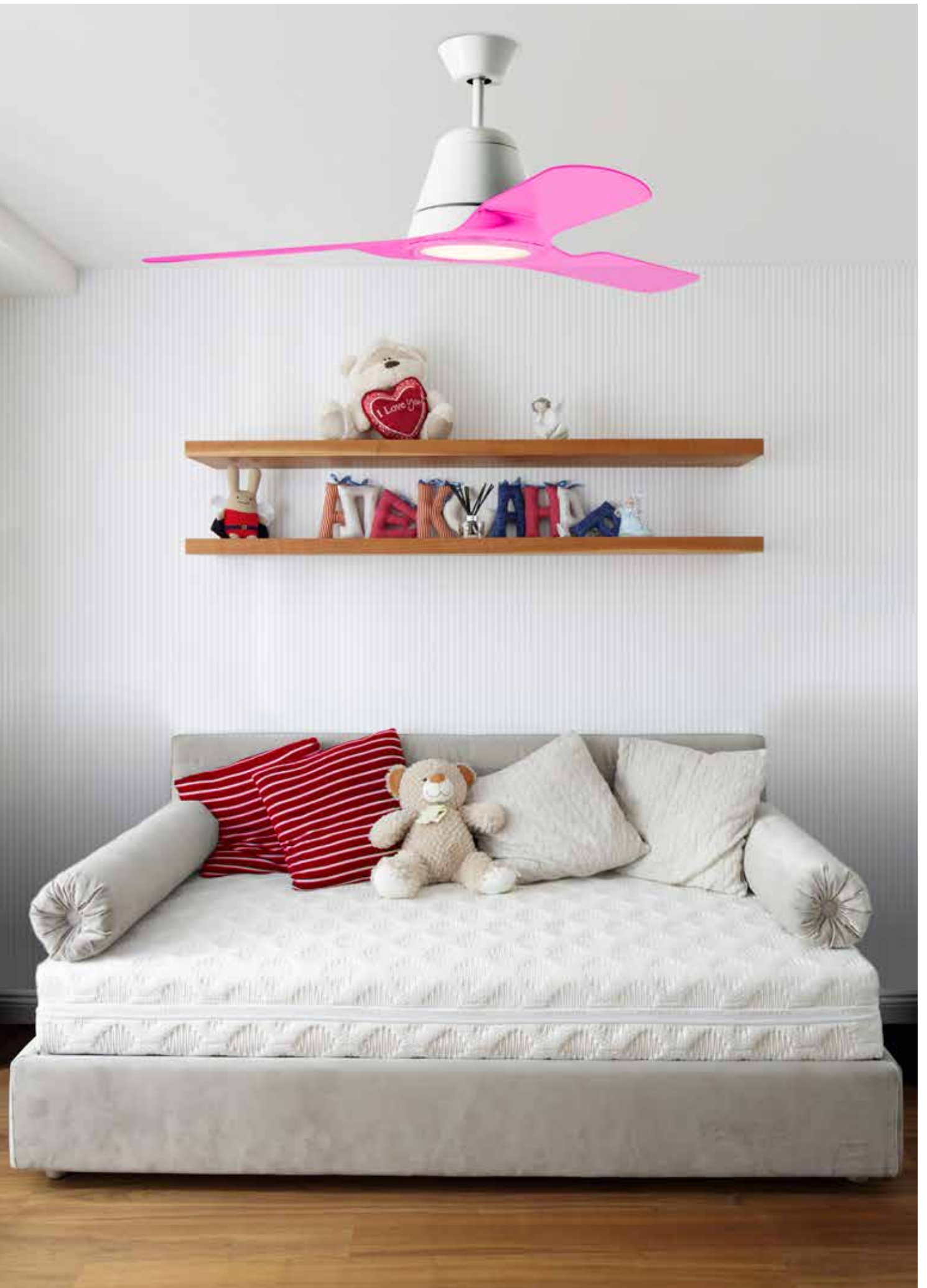

DECORATIVE | CEILING FANS

CEOS

BY BENEDITO DESIGN



30-3250-CF-M1V1



Led 11,4W
3000K | 1400 lm
A**... A

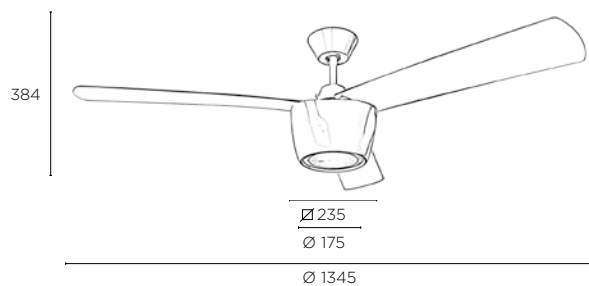



DECORATIVE | CEILING FANS

KLAR

BY ESTUDI RIBAUDÍ



REVERSIBLE



30-4864-16-F9



2xE27 max. 40W | max. L 140 mm Ø 45 mm

Hal, Fluo, Led

A**... C

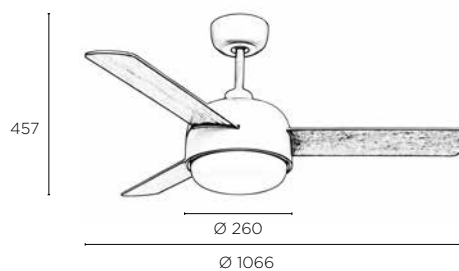

16



P. 699





VINTAGE

BY MANEL LLUSCÀ



30-3248-CG-E9



2xE27 max. 60W | max. L 140 mm Ø 60 mm
Hal, Fluo, Led
A**... C

REVERSIBLE



30-3248-16-E9



2xE27 max. 60W | max. L 140 mm Ø 60 mm
Hal, Fluo, Led
A**... C

REVERSIBLE

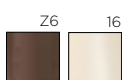
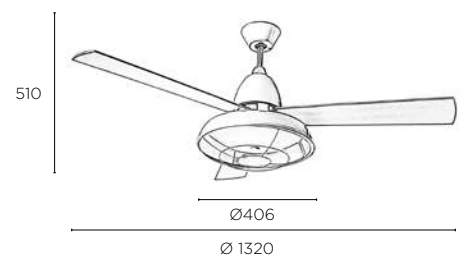



DECORATIVE | CEILING FANS

FUS

BY ESTUDI RIBAUDÍ



REVERSIBLE



30-4865-N3-F9

LED



Led 16,6W
3000K | 1800 lm
A**... A

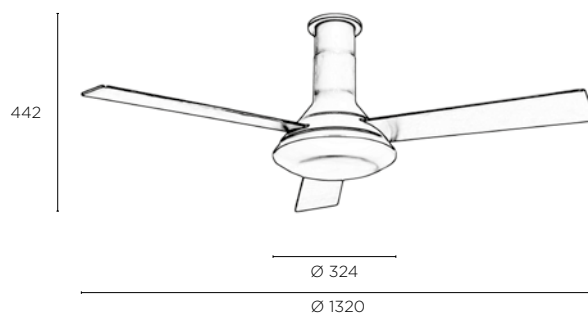



DECORATIVE | CEILING FANS

BAHIA

BY BENEDITO DESIGN



REVERSIBLE



30-4355-CF-M1



2GX13 55W
Fluo
A**... B



REVERSIBLE



30-4355-81-M1



2GX13 55W
Fluo
A**... B

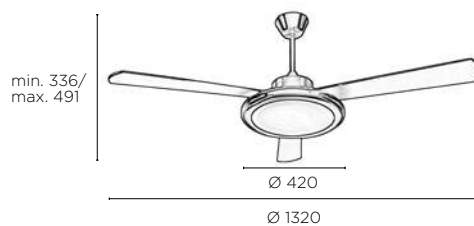

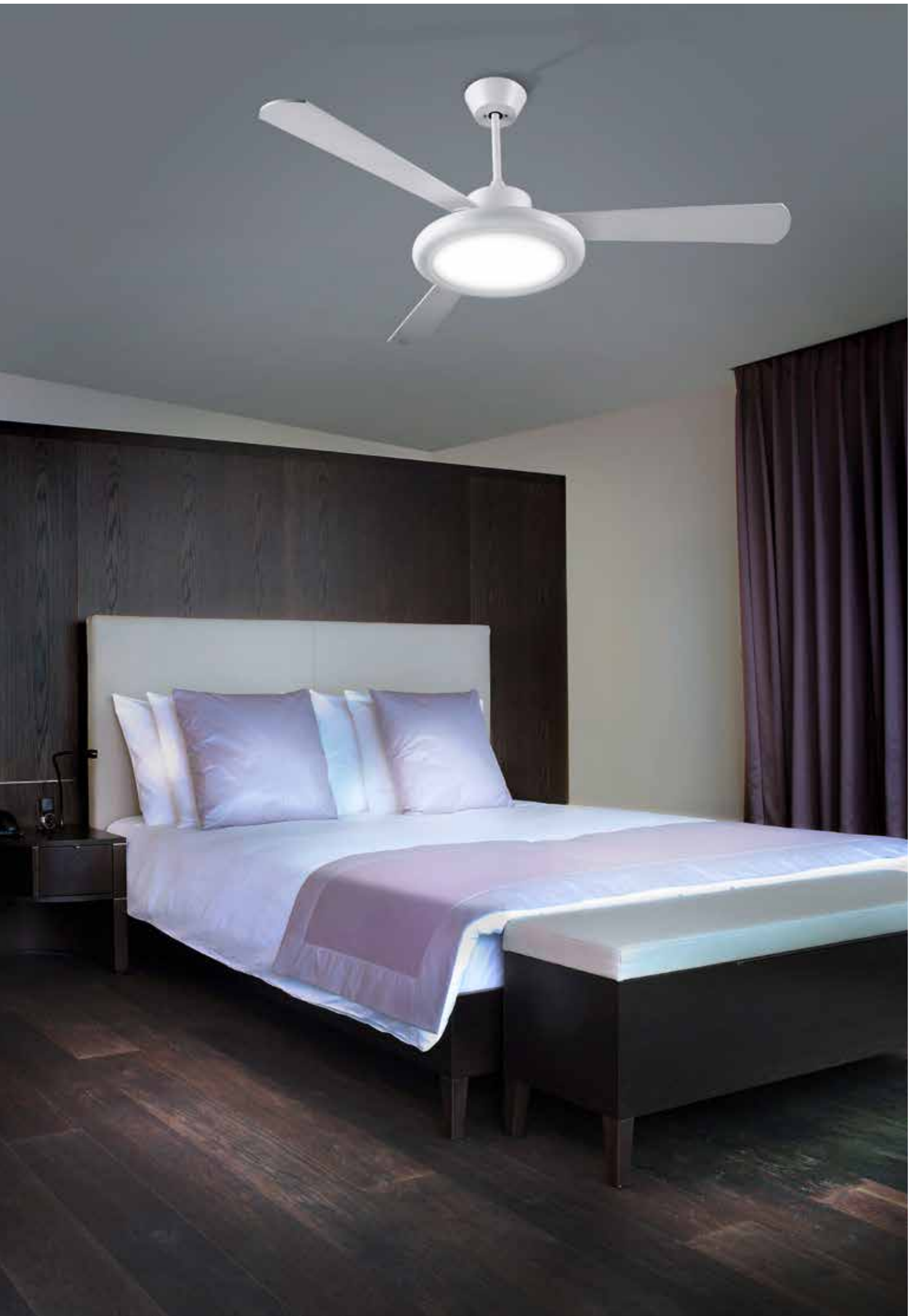

DECORATIVE | CEILING FANS

FORMENTERA

BY ESTUDI RIBAUDÍ



30-4393-CF-M1



E27 max.23W | max. L 140 mm Ø 56 mm
Fluo, Led
A**... C

REVERSIBLE



30-4393-N3-M1



E27 max.23W | max. L 140 mm Ø 56 mm
Fluo, Led
A**... C

REVERSIBLE

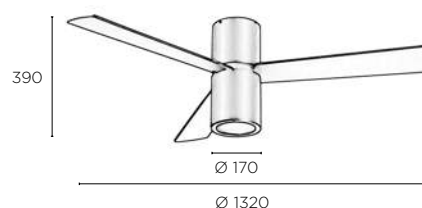

Kit de luz opcional
Optional lighting kit
Kit d'éclairage en option
Licht-Kit als Zubehör
Kit di luce opzionale
Kit de iluminação opcional
Дополнительный световой набор
Zestaw światła do wyboru



71-4393-CF-CF | 71-4393-N3-N3



AR-111 GU10 | max. L 104 MM Ø 111 mm
Led

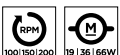
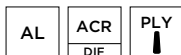



DECORATIVE | CEILING FANS

BORNEO



REVERSIBLE 



30-4399-14-F9



2xE27 max. 60W | max. L 140 mm Ø 45 mm
Hal, Fluo, Led
A**... C



REVERSIBLE 



30-4399-81-F9



2xE27 max. 60W | max. L 140 mm Ø 45 mm
Hal, Fluo, Led
A**... C



REVERSIBLE 



30-4399-E4-F9



2xE27 max. 60W | max. L 140 mm Ø 45 mm
Hal, Fluo, Led
A**... C

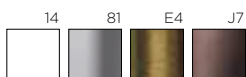
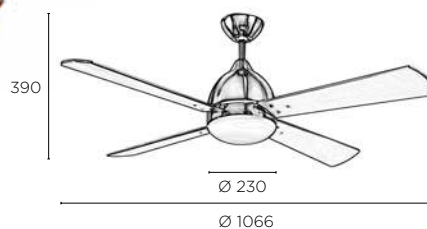



DECORATIVE | CEILING FANS

REVERSIBLE



30-4399-J7-F9

AUKENA

BY ESTUDI RIBAUDÍ



30-1965-81-E9



2xE27 max. 60W | max. L 140 mm Ø 60 mm
Hal, Fluo, Led
A**... C

REVERSIBLE

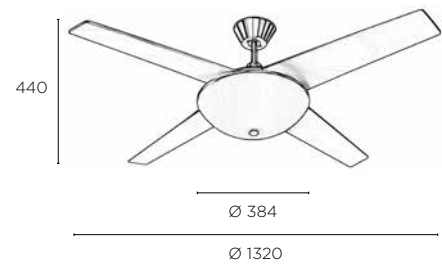

81



P. 699



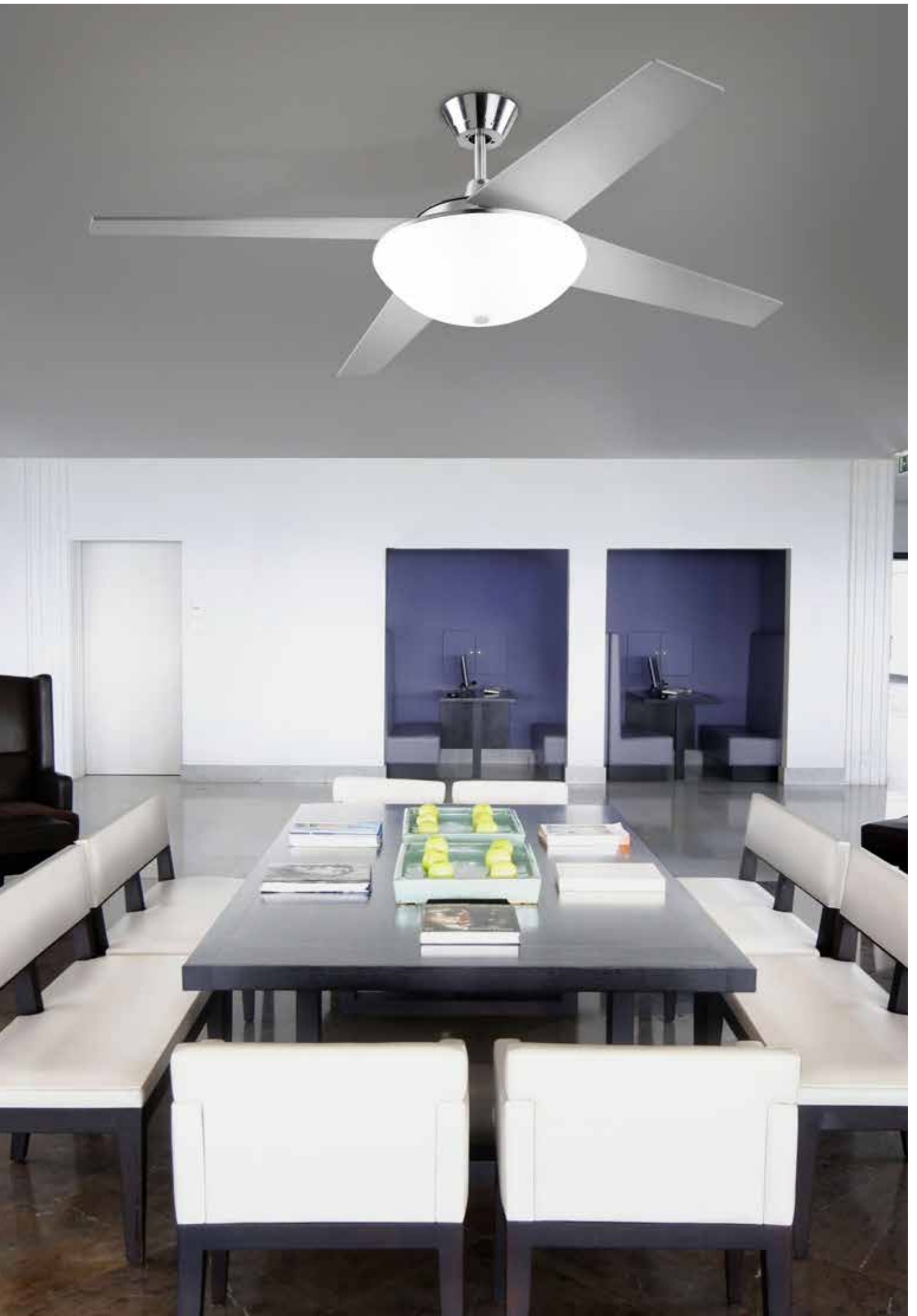

HAWAI



30-2854-81-F9



R7S max. 100W | L 74 mm

INCLUDED

Hal

A**... E

REVERSIBLE



min. 360 / max. 515

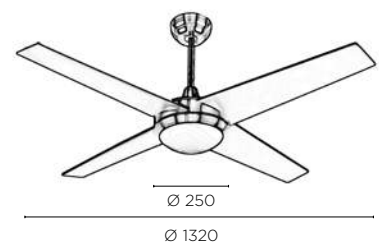

81





DECORATIVE | CEILING FANS

SAMAL



REVERSIBLE 



30-0068-14-F9



2xE27 max. 40W | max. L 115 mm Ø 56 mm
Hal, Fluo, Led
A**... C



REVERSIBLE 



30-0068-81-F9



2xE27 max. 40W | max. L 115 mm Ø 56 mm
Hal, Fluo, Led
A**... C

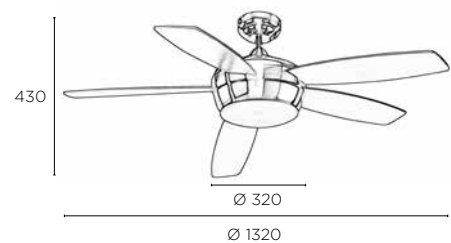



DECORATIVE | CEILING FANS

BELMONT

BY YAGO SARRI



30-4357-81-82 + PAN-226-14



3xE27 max. 60W | max. L 176 mm Ø 56 mm
Hal, Fluo, Led
A**... C

REVERSIBLE



30-4357-81-82 + PAN-146-20V1



3xE27 max. 60W | max. L 176 mm Ø 56 mm
Hal, Fluo, Led
A**... C

min. 388/ max. 543

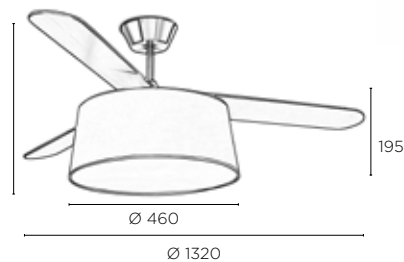

81





DECORATIVE | CEILING FANS



P. 246

P. 248

TORONTO

BY BENEDITO DESIGN



30-4354-81-M1



2GX13 55W
Fluo
A+... B

REVERSIBLE

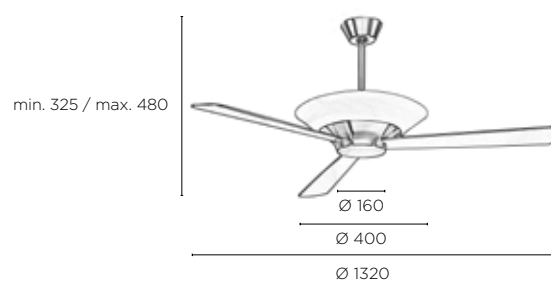

81





DECORATIVE | CEILING FANS

PHUKET



30-4398-J7-J7



Simil ratán
 Similar to rattan
 Imitation rotin
 Rattan-Nachahmung
 Simile al ratán
 Semelhante a rotim
 Под ратан
 Podobny do ratanu

Kit de luz opcional
 Optional lighting kit
 Kit d'éclairage en option
 Licht-Kit als Zubehör
 Kit di luce opzionale
 Kit de iluminação opcional
 Дополнительный световой набор
 Zestaw światła do wyboru

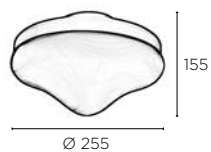

71-4398-J7-F9



2xE27 max. 60W | max. L 140 mm Ø 60 mm
 Hal, Fluo, Led
A... C**

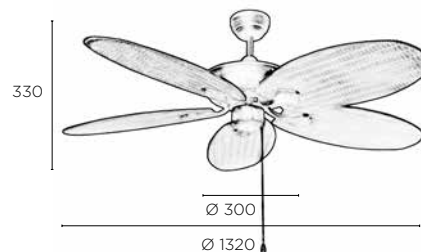



BOUVET



30-1854-CF-F9



2xE27 max. 20W | max. L 115 mm Ø 56 mm
Fluo, Led
A+... C

REVERSIBLE 

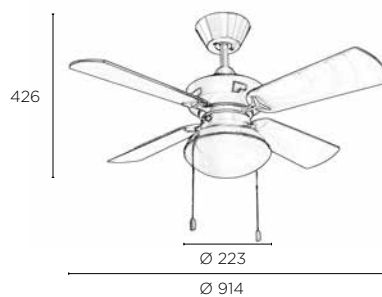

DOMINICA



DECORATIVE | CEILING FANS

30-4405-J7-E7



3xE27 max. 60W | max. L 140 mm Ø 56 mm
Hal, Fluo, Led
A**... C

REVERSIBLE 

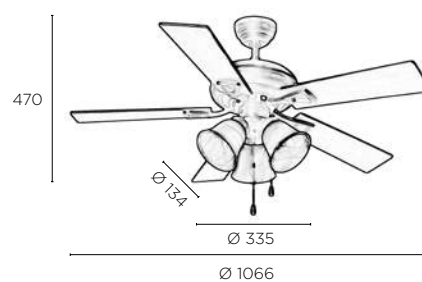

STEM

NEW



30-5377-81-81

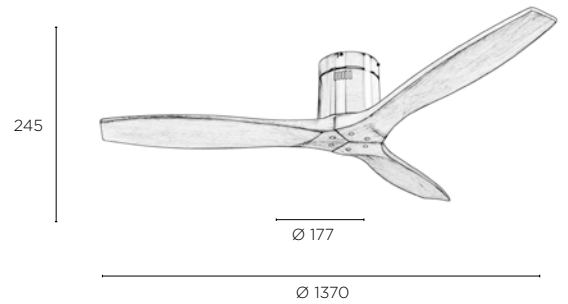

81

	ST	WOOD		100-240V 50-60Hz		P. 451 DC MOTOR	 76 115 150 175 200	 3 171 W 231 36 W				
--	----	------	--	---------------------	--	--------------------	---------------------------	-------------------------	--	--	--	--



TUPAI DC

BY BENEDITO DESIGN



REVERSIBLE



30-4863-CF-CF

L

30-4866-CF-CF

M



REVERSIBLE



30-4863-81-81

L

30-4866-81-81

M

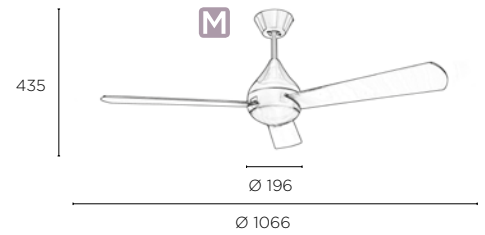
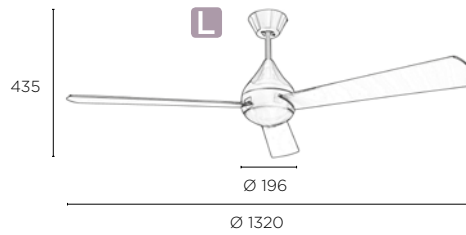

CF	81	ST	PLY		100-240V 50-60Hz		P. 451 DC MOTOR		<table border="1"> <tr> <td>120V/60Hz</td> <td>230V/50Hz</td> <td>120V/60Hz</td> <td>230V/50Hz</td> <td>120V/60Hz</td> <td>230V/50Hz</td> <td>120V/60Hz</td> <td>230V/50Hz</td> </tr> <tr> <td>73 112 155</td> <td>74 112 152</td> <td>3 6 12</td> <td>3 6 13</td> <td>14 159 212</td> <td>108 159 209</td> <td>3 6 12</td> <td>4 6 12</td> </tr> <tr> <td>100 258</td> <td>186 213</td> <td>21 36W</td> <td>21 35W</td> <td>266 308</td> <td>263 306</td> <td>231 35W</td> <td>231 35W</td> </tr> </table>	120V/60Hz	230V/50Hz	120V/60Hz	230V/50Hz	120V/60Hz	230V/50Hz	120V/60Hz	230V/50Hz	73 112 155	74 112 152	3 6 12	3 6 13	14 159 212	108 159 209	3 6 12	4 6 12	100 258	186 213	21 36W	21 35W	266 308	263 306	231 35W	231 35W			
120V/60Hz	230V/50Hz	120V/60Hz	230V/50Hz	120V/60Hz	230V/50Hz	120V/60Hz	230V/50Hz																													
73 112 155	74 112 152	3 6 12	3 6 13	14 159 212	108 159 209	3 6 12	4 6 12																													
100 258	186 213	21 36W	21 35W	266 308	263 306	231 35W	231 35W																													



DECORATIVE | CEILING FANS

MOGAN

BY YAGO SARRI



30-4356-CF-CF

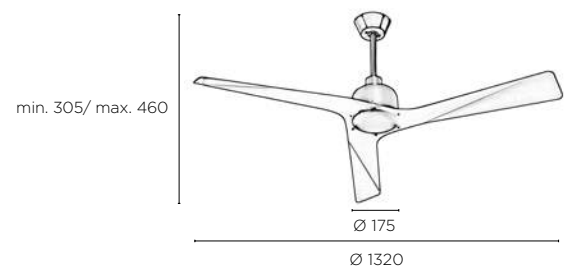



RODAS

BY ESTUDI RIBAUDÍ



30-1964-N3-N3



REVERSIBLE



30-1964-CF-CF



REVERSIBLE



Discos de color incluidos
 Colour disks included
 Disques de couleur fournis
 Farbfilter mitgeliefert
 Dischi colorati inclusi
 Discos de cor incluidos
 Цветные диски включены
 Zawarte kolorowe dyski



Opcional
 Optional
 En option
 Zubehör
 Opzionale
 Opcional
 Дополнительно
 Do wyboru

71-1964-N3-N3

71-1964-CF-CF

Ø 153
66
350

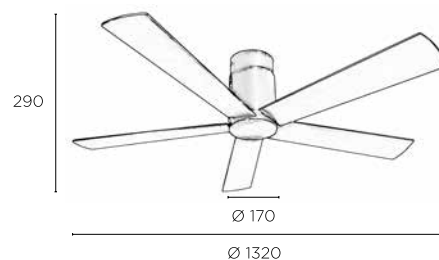



DECORATIVE | CEILING FANS



RENOVATION OF THE BEZARD HOTEL: "ODEON RESIDENCE". NIMES, FRANCE.
DEVELOPER: OCEANIS PROMOTION

OUTDOOR



 **496-511**
SPOTLIGHTS
PROYECTORES
PROJECTEURS ET SPOTS
STRAHLER
PROIETTORI
PROJECTORES
ПРОЖЕКТОРНЫЕ СВЕТИЛЬНИКИ
REFLEKTOR

 **562-573**
CEILING
TECHO
PLAFONNIERS
DECKENLEUCHTEN
PLAFONIERE
ТЕСТО
ПОТОЛОЧНЫЕ
СУФИТОВЕ

 **630-643**
STREET LIGHTS
FAROLAS
RÉVERBÈRES
MASTLEUCHTEN
LAMPIONI
POSTES DE ILUMINAÇÃO
ФОНАРИ
LAMPY ULICZNE

 **661-675**
CLASSIC
CLÁSICO
CLASSIQUE
KLASSISCH
CLASSICO
CLASSICO
КЛАССИЧЕСКИЙ
KLASYCZNY

 **512-519**
WALL WASHERS
BAÑADORES DE PARED
LÈCHE-MURS
STRAHLER
WALL WASHERS
WALL WASHERS
СВЕТИЛЬНИКИ ДЛЯ ПОДСВЕТКИ
СТЕН
WALL WASHER

 **574-605**
RECESSED
— EMPOTRADOS
— ENCASTRÉS
 EINBAULEUCHTEN
— INCASSI
— ENCASTRÁVEIS
 ВСТРАИВАЕМЫЕ
WPUSZCZANE

 **644-649**
WATERPROOF
SUMERGIBLES
SUBMERSIBLES
VERSENKBARE LEUCHTEN
LUCI SOMMERGIBILI
SUBMERSIVEIS
ПОГРУЖАЕМЫЕ В ВОДУ
ZANURZALNE

 **650-660**
CHILL-OUT
CHILLOUT
CHILLOUT
CHILLOUT-BELEUCHTUNG
CHILLOUT
CHILLOUT
ДЛЯ ЗОНЫ ОТДЫХА
CHILLOUT

 **520-561**
WALL FIXTURES
APLIQUES
APPLIQUES
WANDLEUCHTEN
APPLIQUE
APLIQUES
НАСТЕННЫЕ
KINKIETY

 **606-629**
BOLLARDS
BALIZAS
BALISES
POLLERLEUCHTEN
FARI
PIMENTEIROS
НАЗЕМНЫЕ СТОЛБЫ
SŁUPKI



CUBE

- 05-9852-Z5-CLV1 70° 3000K | 1540lm
- 05-9852-Z5-CMV1 70° 4000K | 1820lm
- 05-9851-Z5-CLV1 29° 3000K | 1540lm
- 05-9851-Z5-CMV1 29° 4000K | 1820lm
- 05-9787-Z5-CLV1 14° 3000K | 1540lm
- 05-9787-Z5-CMV1 14° 4000K | 1820lm

Led CREE 14,5W | A**... A

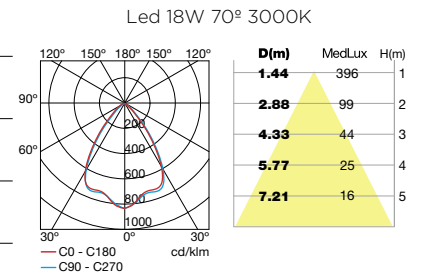
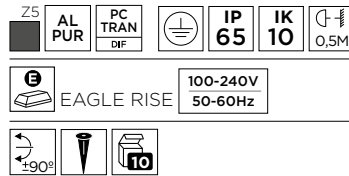
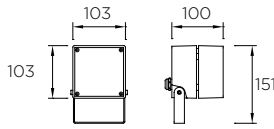

CUBE

- 05-9854-Z5-CL 70° 3000K | 3168lm
- 05-9854-Z5-CM 70° 4000K | 3744lm
- 05-9853-Z5-CL 29° 3000K | 3168lm
- 05-9853-Z5-CM 29° 4000K | 3744lm
- 05-9788-Z5-CL 14° 3000K | 3168lm
- 05-9788-Z5-CM 14° 4000K | 3744lm

Led CREE 32,5W | A**... A

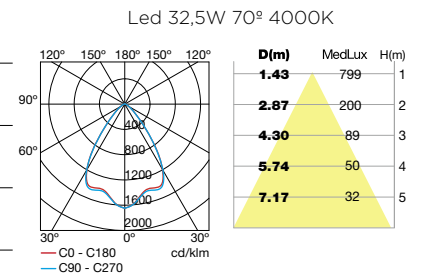
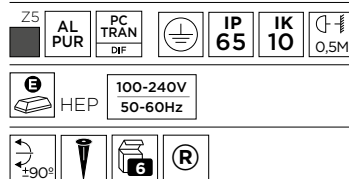
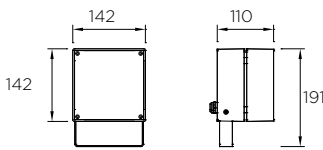

POWELL

- 05-9858-34-CL 32° 3000K | 486lm
- 05-9858-34-CM 32° 4000K | 552lm
- 05-9813-34-CL 11° 3000K | 486lm
- 05-9813-34-CM 11° 4000K | 552lm

Led CREE 6,5W | A**... A

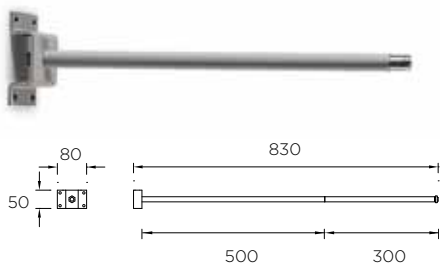
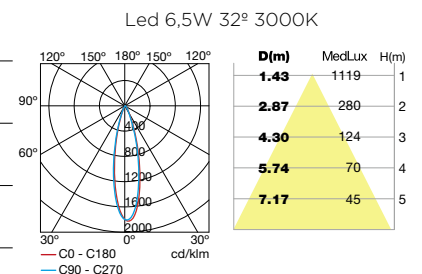
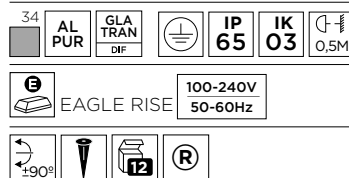
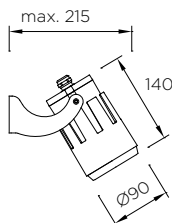

- 71-9487-34-34
- 71-9487-Z5-Z5

Accesorio para / Accessory for / Accessoire pour / Zubehör für / Accessorio per / Acessório para / Принадлежность для / Akcesorium do 05-9856, 05-9731, 05-9858, 05-9813, 05-9851, 05-9852, 05-9787, 05-9853, 05-9854, 05-9788



SPOTLIGHTS



OUTDOOR | SPOTLIGHTS

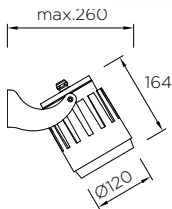

POWELL

05-9856-34-CL 32° 3000K | 1458lm

05-9856-34-CM 32° 4000K | 1656lm

05-9731-34-CL 11° 3000K | 1458lm

05-9731-34-CM 11° 4000K | 1656lm

Led CREE 19,5W | A**... A

34	AL PUR	GLA TRAN DIF		IP 65	IK 03	
	100-240V	50-60Hz				

Led 19,5W 11° 3000K

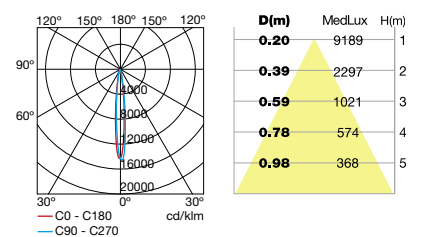

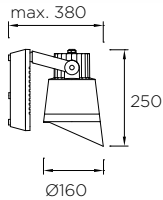

HUBBLE

- 05-9626-34-CL 46° 3000K | 1458lm
- 05-9626-34-CM 46° 4000K | 1656lm
- 05-9850-34-CL 29° 3000K | 1458lm
- 05-9850-34-CM 29° 4000K | 1656lm
- 05-9849-34-CL 8° 3000K | 1458lm
- 05-9849-34-CM 8° 4000K | 1656lm

Led CREE 20W | A**... A

34	AL PUR	GLA TRAN DIF		IP 65	IK 05	
	TCI		DALI	PUSH	100-240V 50-60Hz	

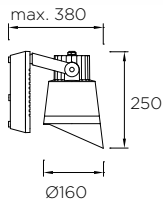
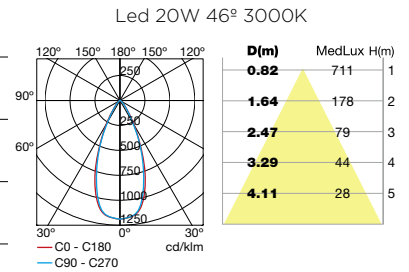

HUBBLE

- 05-9830-34-37 46°
- 05-9861-34-37 29°
- 05-9859-34-37 8°

Led CREE 11W | RGBEASY+ | 490lm | A**... A

34	AL PUR	GLA TRAN DIF		IP 65	IK 05	
	P.694					

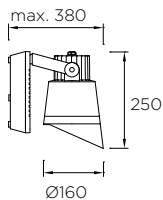

HUBBLE

- 05-9831-34-37 46°
- 05-9862-34-37 29°
- 05-9860-34-37 8°

Led CREE 11W | RGBDMX | 490lm | A**... A

34	AL PUR	GLA TRAN DIF		IP 65	IK 05	
	MEANWELL+	DMX CONTROLLER		100-240V 50-60Hz		

Visera incluida
 Visor included
 Visière comprise
 einschl. Schirm
 Visiera inclusa
 Visiera incluida
 Прилагается защитный козырек
 Osłona w komplecie



CROWNE PLAZA HOTEL. LIÈGE, BELGIUM

A

B

Visiera + 2 reflectores incluidos
 Visor + 2 reflectors included
 Visière + 2 réflecteurs compris
 einsch. Schirm + 2 Reflektoren
 Visiera + 2 riflettori inclusi
 Viseira + 2 reflectores incluidos
 Прилагается защитный козырек + 2
 отражателя
 Ośłona + 2 odbłyśniki w komplecie

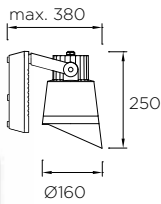

HUBBLE

05-9501-34-37

G8,5 35W HID | A*... A

34	AL PUR	GLA TRAN DIF	IP 65	IK 05	0,2M
E	220-240V 50-60Hz				
±90°	360°	28°	18°	2	R

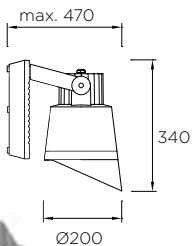
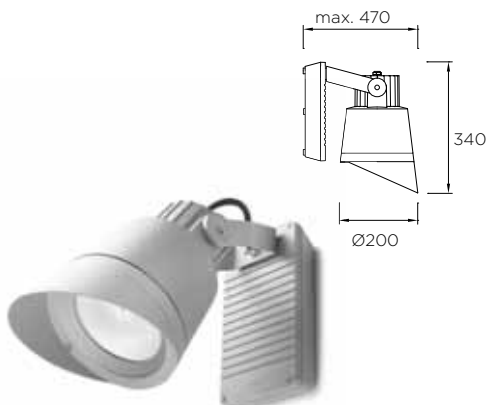
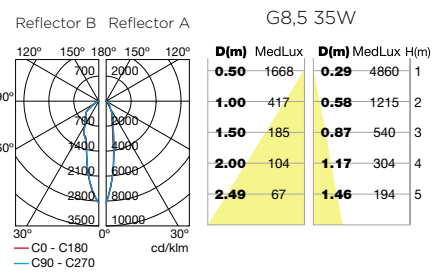

HUBBLE

05-9474-34-37

70W

05-9502-34-37

150W

G12 HID | A*... A

34	AL PUR	GLA TRAN DIF	IP 65	IK 05	0,5M
E	220-240V 50-60Hz				
±90°	360°	53°	25°	2	R

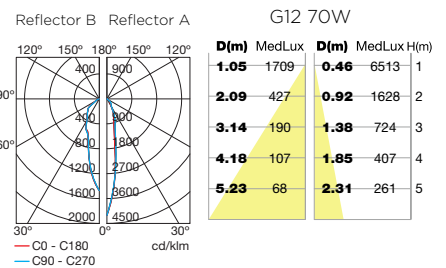



PANS & COMPANY SABADELL. BARCELONA, SPAIN.



HUBBLE

05-9722-05-37 ■

05-9722-14-37 □

GU-10/MR-16 max. 35W | max. L 80mm
Hal - Fluo | A**... C

05	14	TEC POLI	GLA TRAN DIF	IP 65	IK 06	0,5M
----	----	----------	--------------	-------	-------	------

±90°	TEC POLI	GLA TRAN DIF	®
------	----------	--------------	---

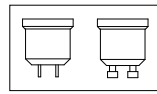

GU5.3 + GU10



GU-10 35W

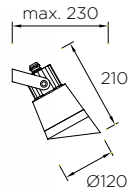
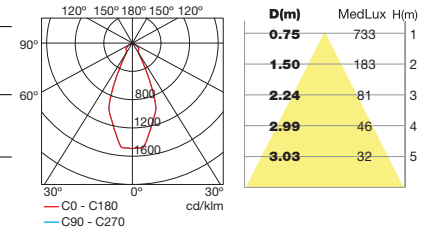

HUBBLE

05-9416-34-37 ■

05-9416-Z5-37 ■

GU-10 max. 50W | max. L 80mm
Hal - Fluo | A**... C

34	Z5	AL PUR	GLA TRAN DIF	IP 65	IK 06	0,5M
----	----	--------	--------------	-------	-------	------

±90°	AL PUR	GLA TRAN DIF	®
------	--------	--------------	---

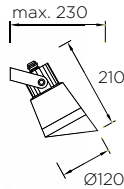
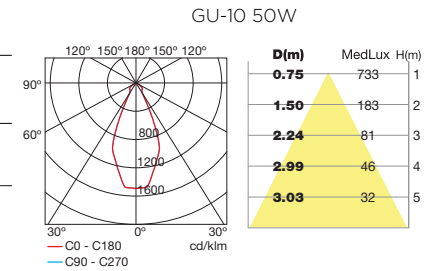

71-9746-05-05 ■

Accesorio para / Accessory for / Accessoire pour / Zubehör für / Accessorio per / Acessório para / Принадлежность для / Akcesorium do 05-9416, 05-9722, 05-9881

05	PC	100
----	----	-----

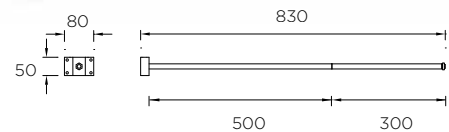
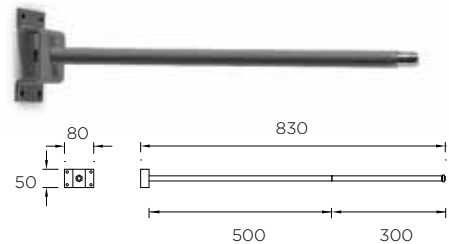
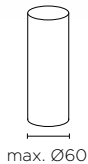

71-9487-34-34 ■

71-9487-Z5-Z5 ■

Accesorio para / Accessory for / Accessoire pour / Zubehör für / Accessorio per / Acessório para / Принадлежность для / Akcesorium do 05-9416, 05-9722, 05-9881

34	Z5	ST EPOXY	10
----	----	----------	----

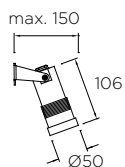

MICRO NEW



05-9881-X8-CM ■

Led CREE 3W | 4000K | 396lm | A**... A

X8	AL PUR	GLA TRAN DIF		IP 65
----	--------	--------------	--	-------

	EAGLE RISE	100-240V 50-60Hz
--	------------	---------------------

--	--	--	--	--	--	--



2 reflectores incluidos.
2 reflectors included.
2 réflecteurs inclus.
2 Reflektore inklusive.
2 riflettori inclusi.
2 reflectores incluidos
Прилагаются 2 отражателя.
2 odbłyśniki w komplecie



MIDI

05-3358-N3-37

Led CREE 7,1W | 4000K | 510lm | A**... A

34	AL	GLA TRAN DIF	IP 65	IK 10	RF 850°C
	P.682		max. 350 mA	max. 700 mA	

Led 7,1W

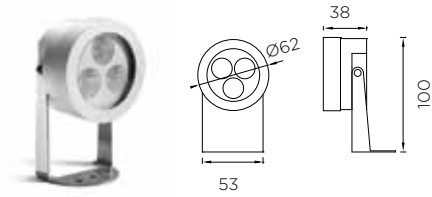
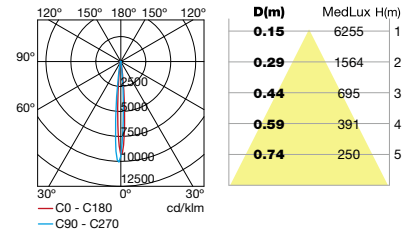

AQUA

05-9889-CA-CM

NEW

Led LG 5W | 4000K | 663lm | A**... A

CA	INOX AISI 316	GLA HARD DIF	IP 68	1m	IK 10	RF 850°C
	12 VAC	P.691				

Led 5W

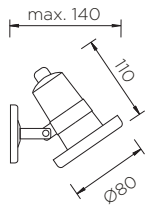
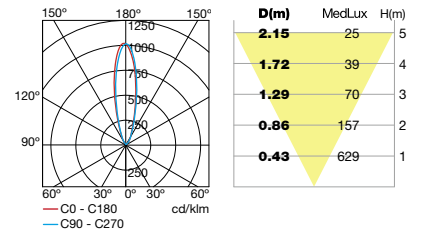

AQUA

05-9245-CA-37V1

GU5.3 max. 50W | max. L 55mm
Hal - Fluo | A**... C

CA	INOX AISI 316	GLA HARD DIF	IP 68	1m	IK 10	RF 850°C
	12 VAC	P.691				

GU5.3 50W

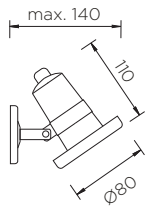
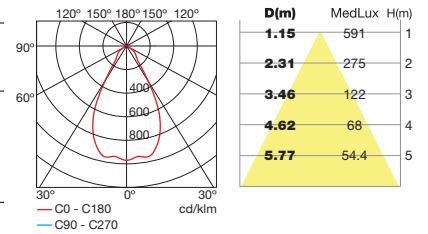

P.703

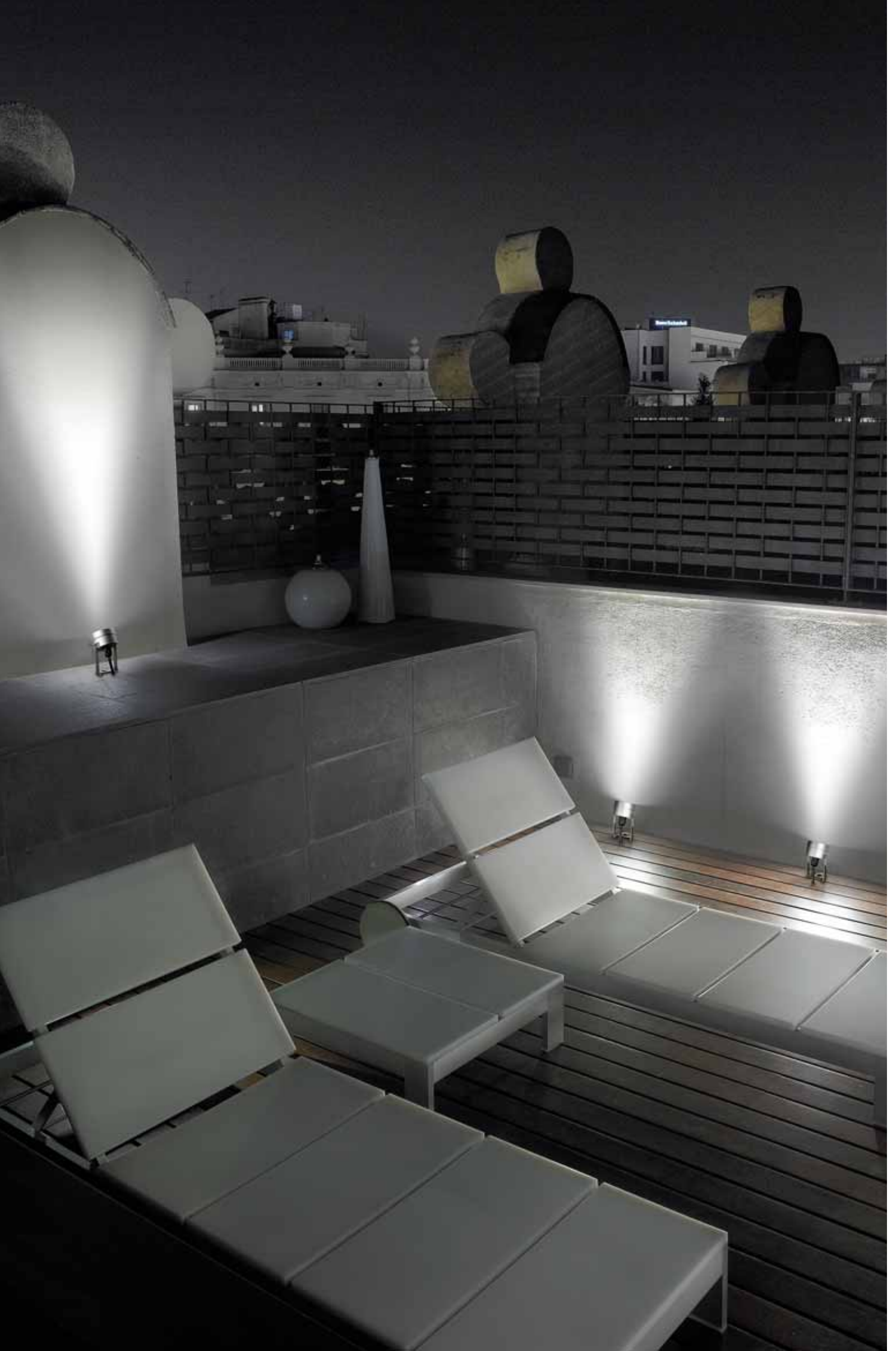

OUTDOOR | SPOTLIGHTS



PREMIER

80-4972-BQ-M2

Led LUMILEDS 120W | 4000K | 12868lm | A++... A

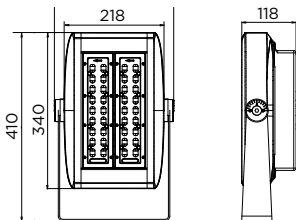
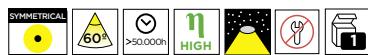
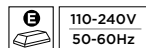

Led 120W 4000K
ULOR INST = 0%

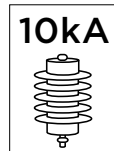
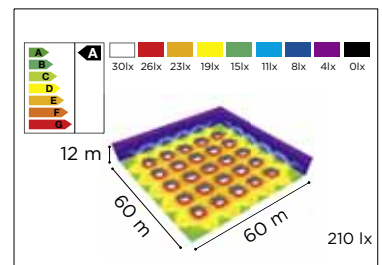
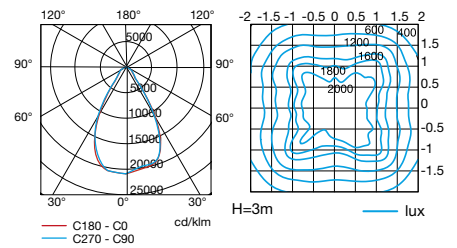

Protección sobretensiones 10kA.
Surge protection 10kA.
Protecteur de surtension 10kA.
Überspannungsschutz 10kA.
Protetto dalla sovrentensione da 10kA.
Сетевой фильтр 10kA.
Zabezpieczenie Przeciwprzepięciowe 10kA.



ARENAS SHOPPING CENTER. BARCELONA, SPAIN.

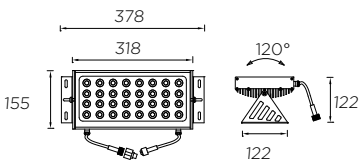

RAY

05-2499-54-H6 3000K | 3500lm

05-2494-54-H6 4000K | 4000lm

Led CREE 48W | A**... A



Led 48W 4000K

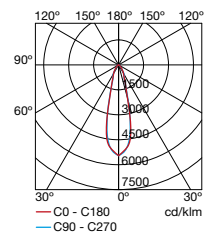

Led 48W 3000K

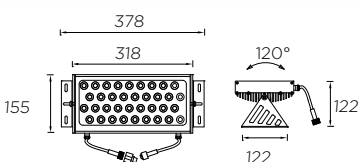
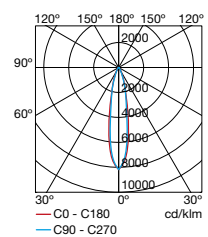

RAY

05-2498-54-H6

36 Led CREE 60W | 2500lm | RGB | A**... A

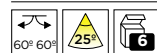

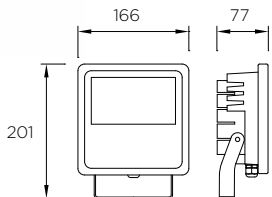

PROY

05-9739-05-37

Led CITIZEN 20W | 3000K | 2000lm | A+... A



Led 20W

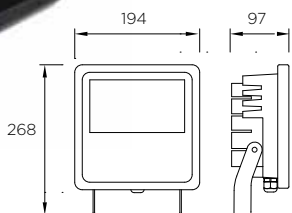
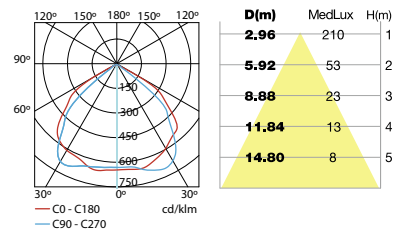

PROY

05-9841-05-CL

Led CITIZEN 45W | 3000K | 4704lm | A+... A

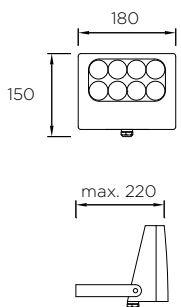

SHULL

05-9652-34-M2 3000K | 1296lm

05-9598-34-M2 4000K | 1472lm

Led CREE 17W | A+... A



Led 17W

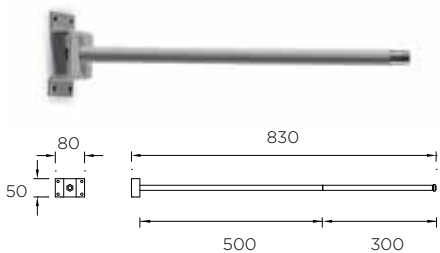
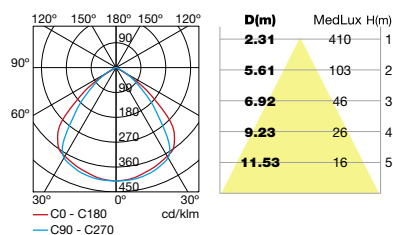

71-9487-34-34

71-9487-Z5-Z5

Accesorio para / Accessory for / Accessoire pour / Zubehör für / Accessorio per / Acessório para / Принадлежность для / Akcesorium do 05-9739, 05-9841, 05-9598, 05-9652



71-9746-05-05

Accesorio para / Accessory for / Accessoire pour / Zubehör für / Accessorio per / Acessório para / Принадлежность для / Akcesorium do 05-9598, 05-9652

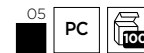

max. Ø60



SKADE

05-9870-34-CL

05-9870-Z5-CL

NEW

Led BRIDGELUX 9W | 3000K | 605lm | A+... A



Led 9W

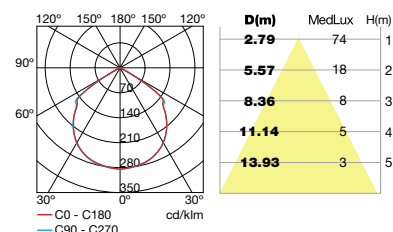



APRIL NEW

05-9896-Z5-CL ■

Led OSRAM 11W | 3000K | 1134lm | A**... A



Z5	AL PUR	PC TRAN DIF		IP 65
	100-240V 50-60Hz			

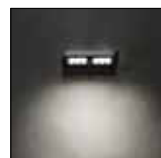
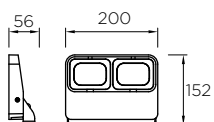

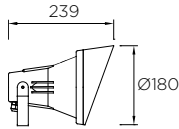

ESPARTA

05-9789-34-37

05-9789-Z5-37

NEW

Par-38 E27 max. 80W | max. L 140 mm
Hal - Fluo | A**... C

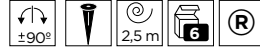

E27 60W

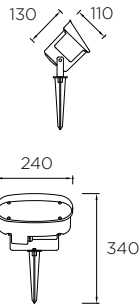
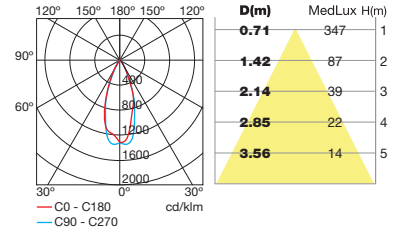

ESPARTA

55-9701-Z5-M3

E27 max. 18W | max. L 160 mm
Fluo | A**... C



E27 18W

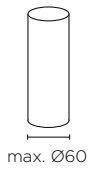
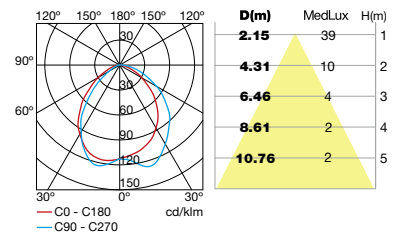

71-9746-05-05

Accesorio para / Accessory for /
Accessoire pour / Zubehör für /
Accessorio per / Acessório para /
Принадлежность для / Akcesorium
do dla 55-9701

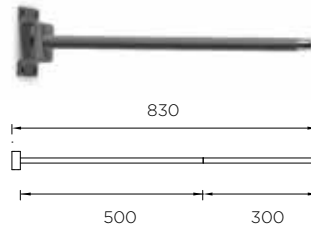

71-9487-34-34

71-9487-Z5-Z5

Accesorio para / Accessory for /
Accessoire pour / Zubehör für /
Accessorio per / Acessório para /
Принадлежность для / Akcesorium
do 05-9789, 55-9701

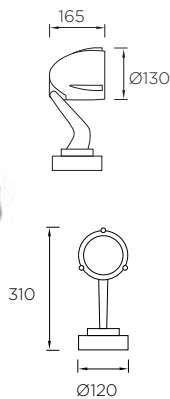
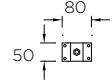

ALIEN

05-9296-Z5-37

Par-30 E27 max. 75W | max. L 90 mm Ø 97 mm
Hal - Fluo | A**... B

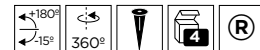

Par-30 75W

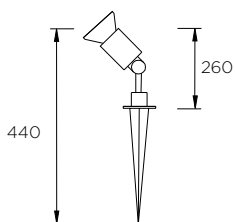
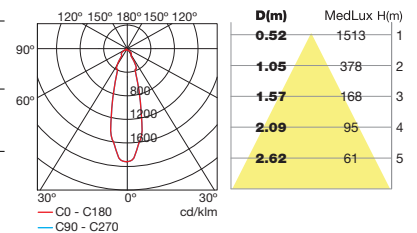

ESPARTA

55-8784-05-05

Par-38 max. 100W
Hal - Fluo - Led | A**... C

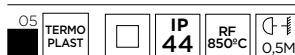

Par-38 100W

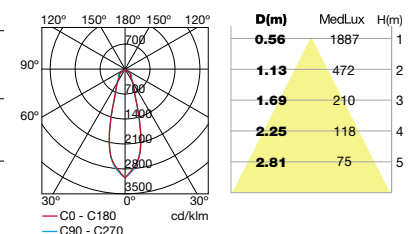

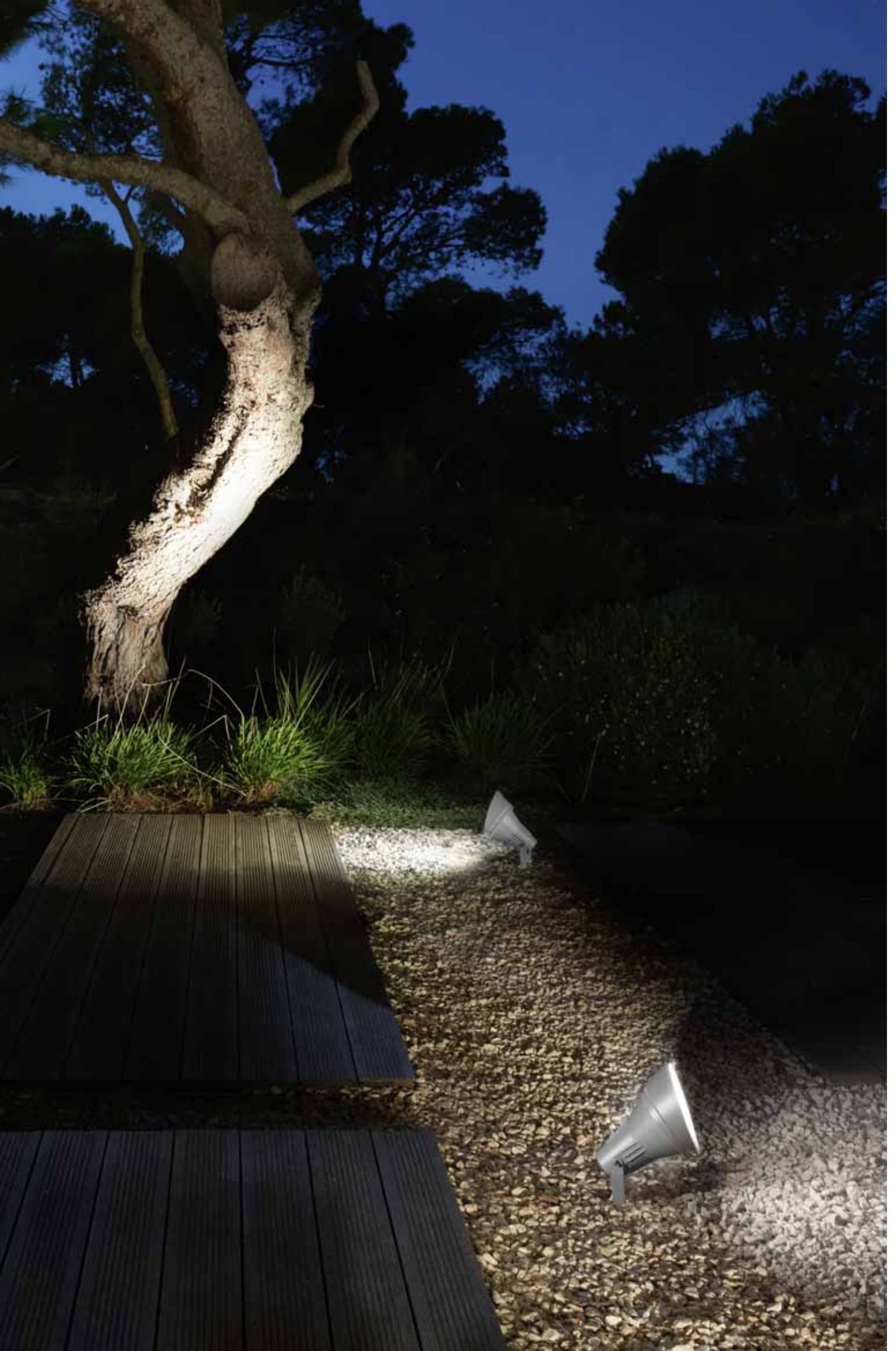

OUTDOOR | SPOTLIGHTS



P.703



HELIO

05-9310-CA-37

GU-10 max. 50W | max. L 80 mm
Hal - Fluo | A**... C

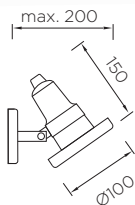

GU-10 50W

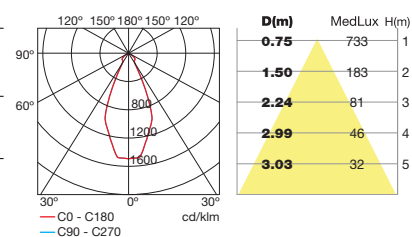

EOLO

05-9122-Y4-37

GU-10 max. 50W | max. L 70 mm
Hal - Fluo | A**... C

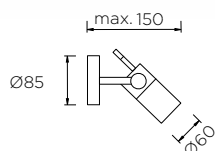

GU-10 50W

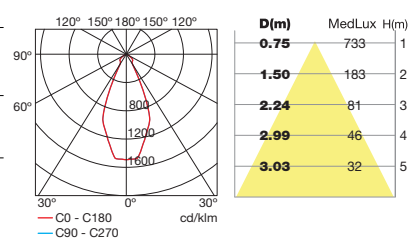

SKADE

05-9107-34-37

05-9107-Z5-37

R7s L=78 max. 150W | A**... C

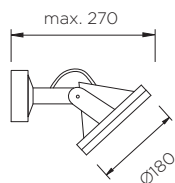
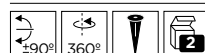

R7s 150W

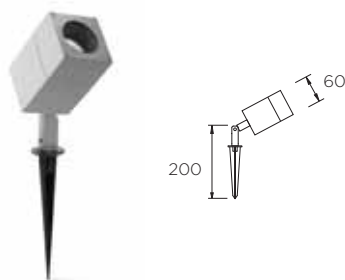
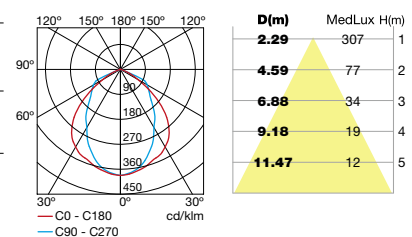

ICARO

55-9191-34-37

GU-10 max. 50W | max. L 75 mm
Hal - Fluo | A**... C



GU-10 50W

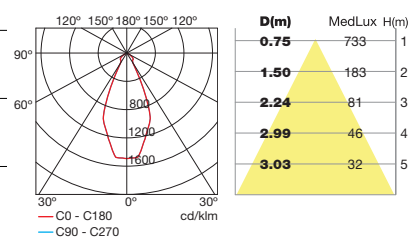



HELIO

05-9640-05-37 ■

05-9640-14-37 □

05-9640-34-37 ■

GU-10 max. 50W | max. L 80 mm
Hal - Fluo | A**... C

05	14	34	AL INJ	GLA HARD DIF	IP 65	IK 10	RF 850°C
0.5M							

GU-10 50W

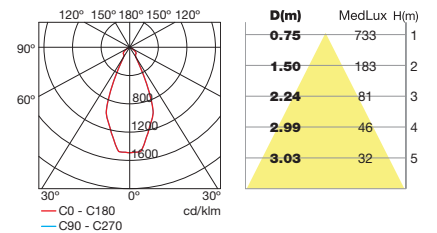

71-9746-05-05 ■

Accesorio para / Accessory for /
Accessoire pour / Zubehör für /
Accessorio per / Acessório para /
Принадлежность для / Akcesorium
do dla 05-9640

05	PC	100
----	----	-----

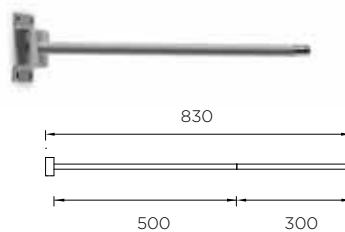

71-9487-34-34 ■

71-9487-Z5-Z5 ■

Accesorio para / Accessory for /
Accessoire pour / Zubehör für /
Accessorio per / Acessório para /
Принадлежность для / Akcesorium
do 05-9640

34	Z5	ST EPOXY	10
----	----	----------	----

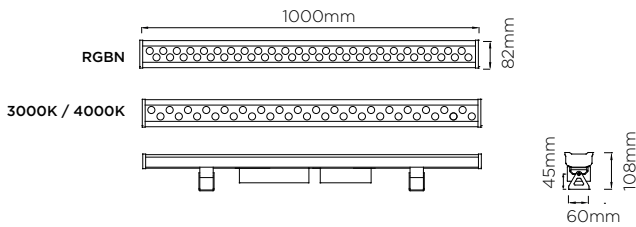

SANAT

Led 70W | A**... A

54	AL	UVA GLA DF	IP 65
E MEAN WELL + CONTROLLER		DMX DIMMING	100-277V 50-60Hz
170°			

COMO CONSTRUIR LA REFERENCIA/ HOW TO CREATE THE REFERENCE/ COMMENT CONCEVOIR LA RÉFÉRENCE/ ZUSAMMENSETZUNG EINER BESTELLNUMMER/ COME COSTRUIRE IL RIFERIMENTO/ COMO CONSTRUIR A REFERÊNCIA/ КАК ПОСТРОИТЬ АРТИКУЛ / JAK UTWORZYĆ NR REFERENCYJNY

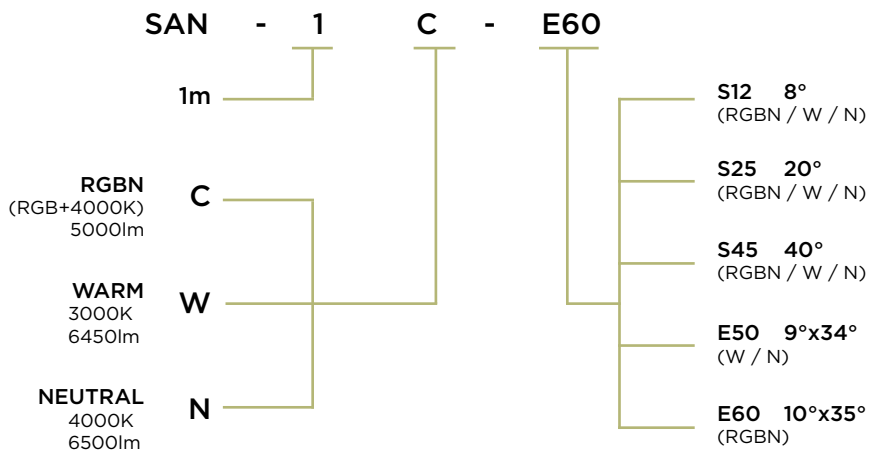

Ejemplo / Example / Exemple / Beispiel / Exemplo / Esempio / Пример / Przykład:

SAN-1C-E60

WALL WASHERS

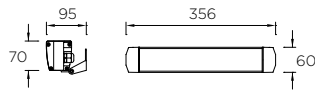

CONVERT

05-9749-54-CL 3000K | 852lm

05-9749-54-37 4000K | 978lm

Led CREE 12W | A+... A



Led 12W 3000K

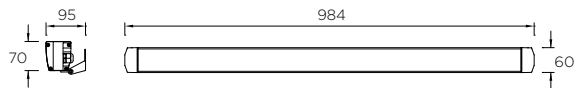
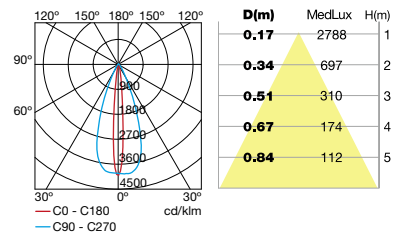

CONVERT

05-9750-54-CL 3000K | 2556lm

05-9750-54-37 4000K | 2934lm

Led CREE 36W | A+... A



Led 36W 3000K

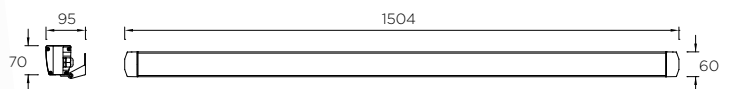
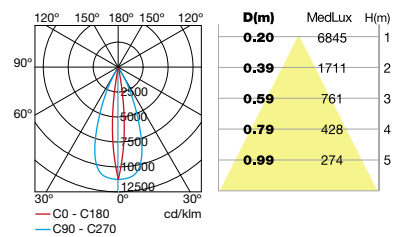

CONVERT NEW

05-9916-54-CL 3000K | 3407lm

05-9916-54-CM 4000K | 3898lm

Led CREE 58W | A+... A





Accesorios para fijación en pared o techo incluidos.
 Accessories for wall or ceiling fitting included.
 Accessoires de fixation murale ou au plafond inclus.
 Zubehöre zur Befestigung an Wänden und Decken inklusive.
 Accessori per fissaggio nella parete o tetto inclusi.
 Acessórios para a fixação em parede ou tecto incluídos.
 Настенный или потолочный крепеж в комплекте.
 Akcesoria do montażu na ścianie/suficie w komplecie

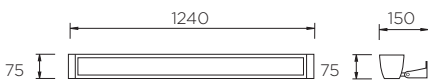

HECATE

05-9266-Z5-37

T5 54W Fluó | A**... B

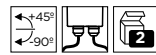
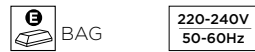

T5 54W

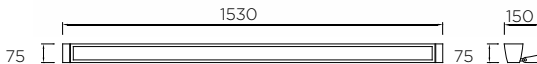
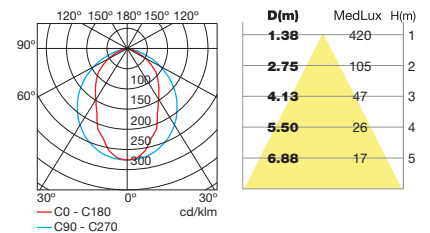

HECATE

05-9439-Z5-37

T5 80W Fluó | A**... B



T5 80W

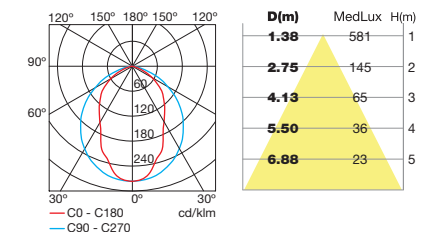

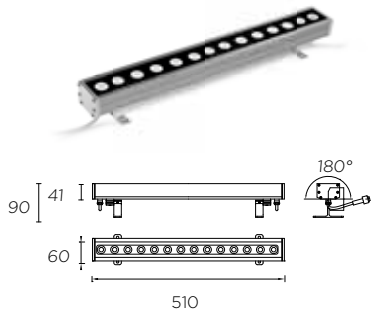

TRON

05-1547-54-H6 3000K | 1750lm
 05-1546-54-H6 4000K | 2000lm

Led CREE 24W | A+... A

54	AL	UVA GLA DIF	IP 65	IK 05	RF 850°C
	P.686		24 VDC		

Led 24W 4000K

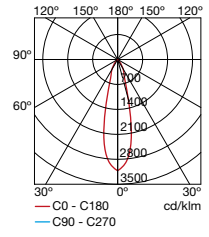

Led 24W 3000K

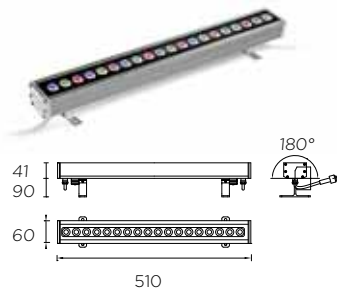
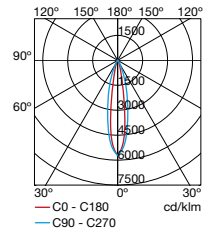

TRON

05-1544-54-H6

Led CREE 30W | 1250lm | RGB | A+... A

54	AL	UVA GLA DIF	IP 65	IK 05	RF 850°C
	P.686		24 VDC		

Led 48W 4000K

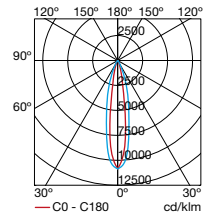

Led 48W 3000K

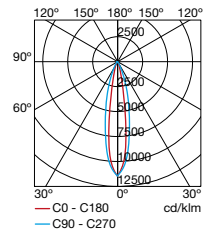

TRON

05-1552-54-H6 3000K | 3500lm
 05-1549-54-H6 4000K | 4000lm

Led CREE 48W | A+... A

54	AL	UVA GLA DIF	IP 65	IK 05	RF 850°C
	P.686		24 VDC		

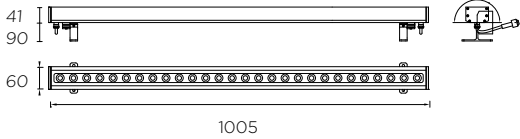

TRON

05-1548-54-H6

Led CREE 60W | 2500lm | RGB | A+... A

54	AL	UVA GLA DIF	IP 65	IK 05	RF 850°C
	P.686		24 VDC		

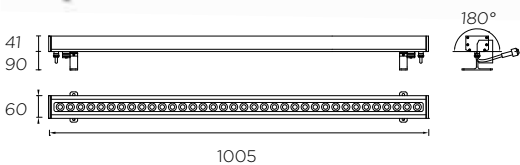

OUTDOOR | WALL WASHERS

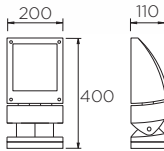

POMPEYA

05-9537-34-37 35W
 05-9538-34-37 70W
 05-9539-34-37 150W

G12 HID | A+... A

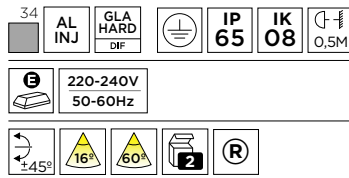

2 reflectores incluidos.
 2 reflectors included.
 2 réflecteurs inclus.
 2 Reflektore inklusive.
 2 riflettori inclusi.
 2 reflectores incluidos

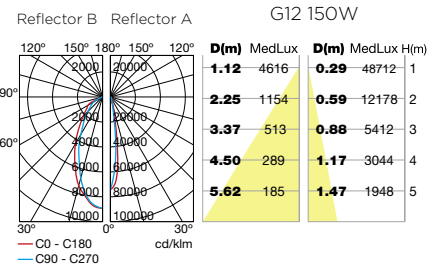

Прилагаются 2
 отражателя.
 2 odbłyśniki w komplecie

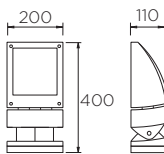

POMPEYA

05-9254-34-37

2 x GX24q-3 26W Fluo | A+... B

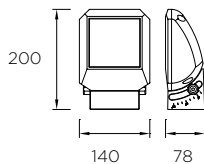
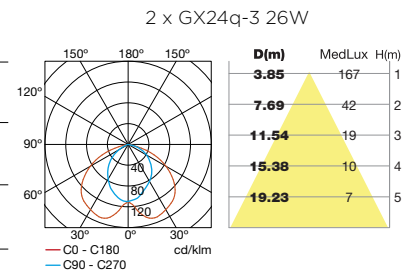
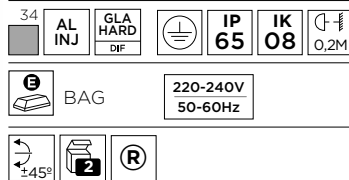

POMPEYA

05-9751-34-CMV1 4000K | 1733 lm
 05-9751-34-CLV1 3000K | 1575 lm **NEW**

Led 15W | A+... A

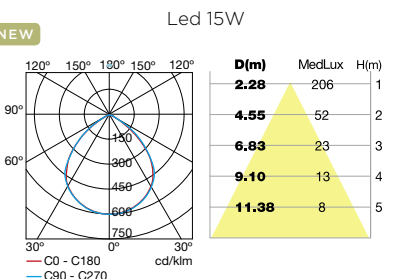
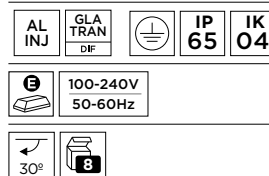

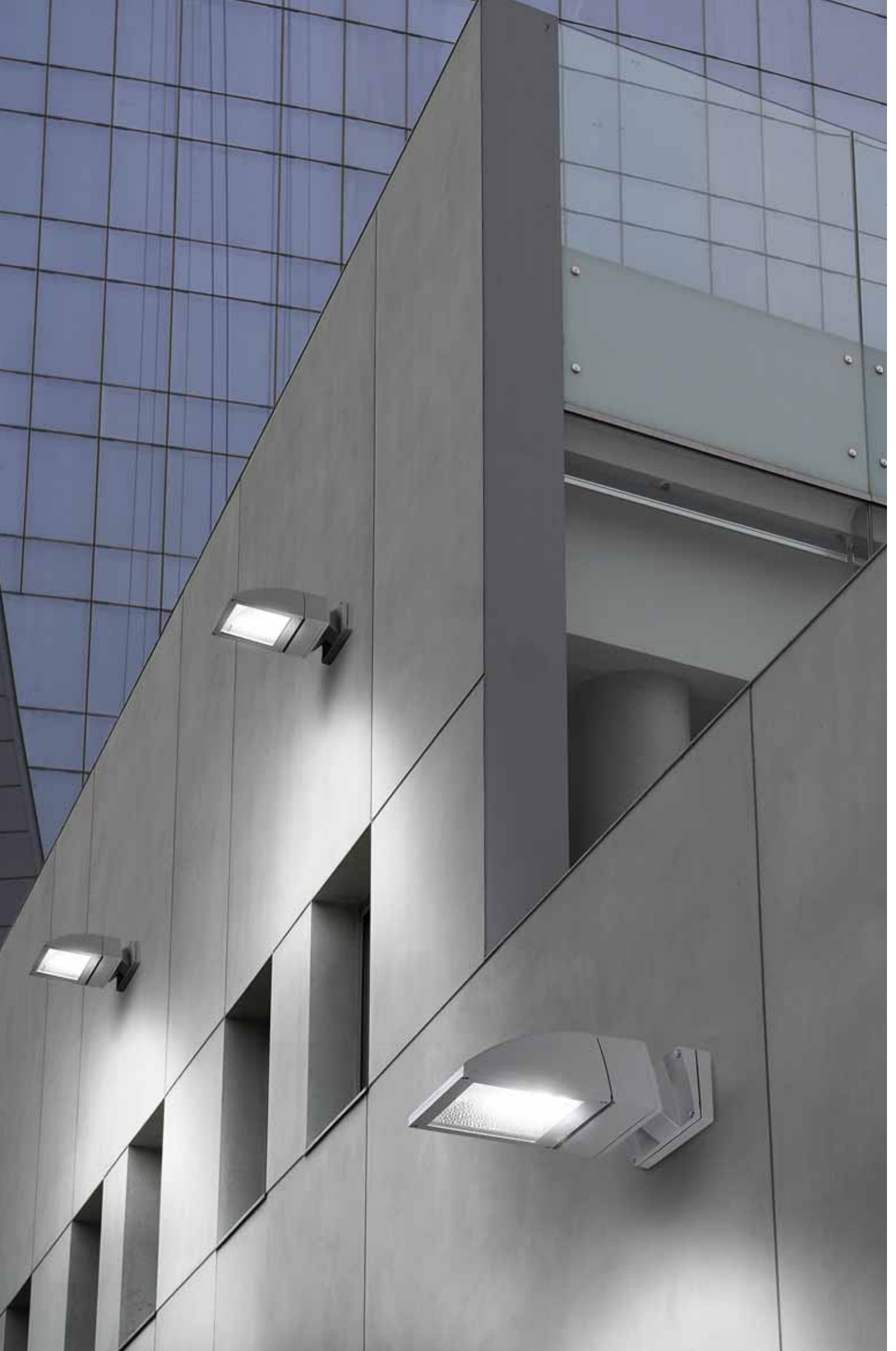

OUTDOOR | WALL WASHERS



LT-20

Led max. 12W/m | 300lm | A**... A



CUALQUIER DUDA CONSULTE CON NUESTRO EQUIPO COMERCIAL.
 ANY DOUBT, PLEASE QUERY OUR SALES TEAM.
 CONSULTEZ NOTRE ÉQUIPE COMMERCIALE POUR TOUT RENSEIGNEMENT.
 UNSERE VERTRIEBSMITARBEITER BERATEN SIE GERN.
 PER QUALSIASI DUBBIO, RIVOLGERSI AL NOSTRO TEAM COMMERCIALE.
 PARA ESCLARECER DÚVIDAS CONSULTE A NOSSA EQUIPA COMERCIAL.
 ПО ЛЮБЫМ ВОПРОСАМ ОБРАЩАЙТЕСЬ В НАШ КОММЕРЧЕСКИЙ ОТДЕЛ.
 W PRZYPADKU JAKIEJKOLWIEK WĄTPLIWOŚCI PROSIMY SKONTAKTOWAĆ SIĘ Z
 NASZYM DZIAŁEM HANDLOWYM.





PAMPLONA HOTEL. MALLORCA, SPAIN.



OUTDOOR | WALL WASHERS



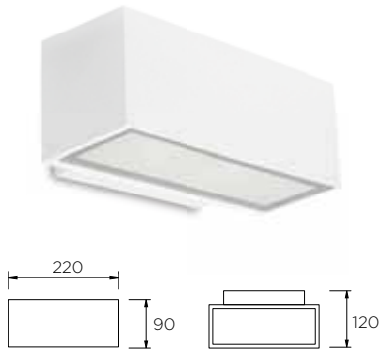

AFRODITA NEW

05-9911-14-CL

05-9911-Z5-CL

Led 17,5W | 3000K | 1908lm | A**... A

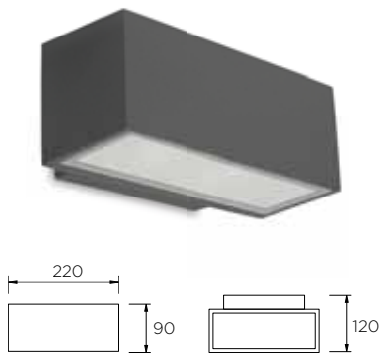

AFRODITA NEW

05-9912-14-CL

05-9912-Z5-CL

Led 11,5W | 3000K | 1219lm | A**... A

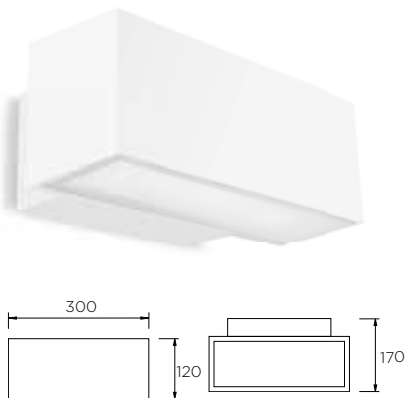
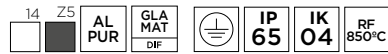

AFRODITA NEW

05-9878-14-CL

05-9878-Z5-CL

Led 39W | 3000K | 4198lm | A**... A

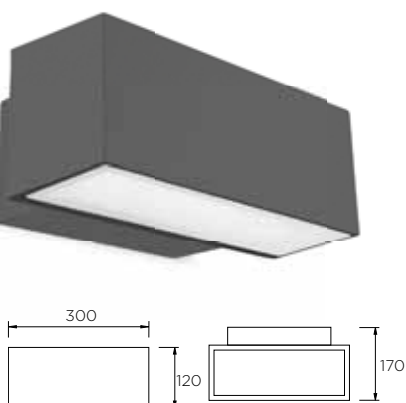
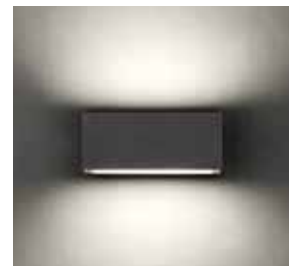
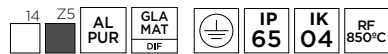

AFRODITA NEW

05-9879-14-CL

05-9879-Z5-CL

Led 19W | 3000K | 2120lm | A**... A

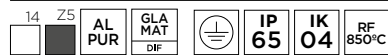

WALL FIXTURES

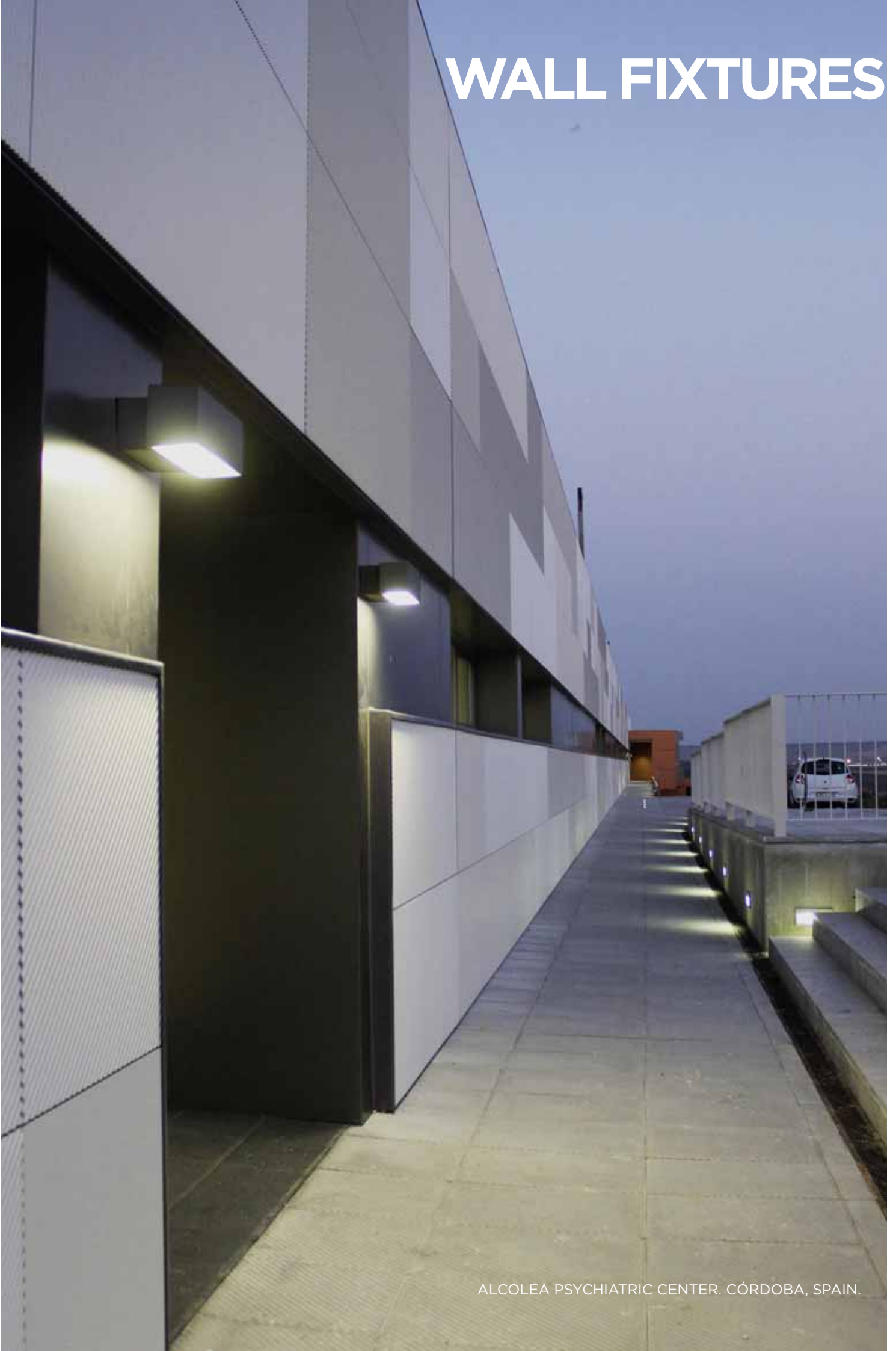

OUTDOOR | WALL FIXTURES

ALCOLEA PSYCHIATRIC CENTER. CÓRDOBA, SPAIN.

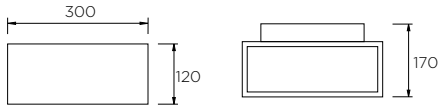

AFRODITA

05-9228-14-37



05-9228-34-37



05-9228-Z5-37



2 x G24q-3 26W Fluor | A**... B

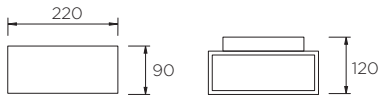
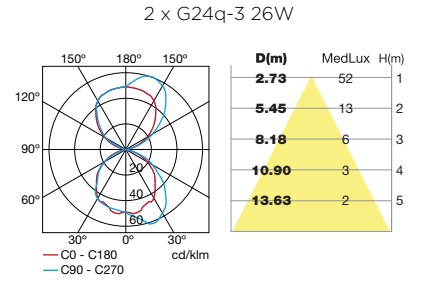
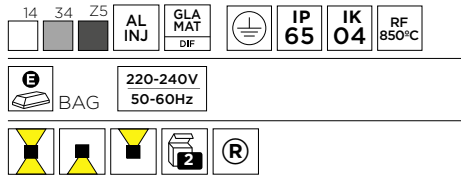

AFRODITA

05-9229-14-37



05-9229-34-37



05-9229-Z5-37



R7s L=78 max. 150W Hal | A**... C

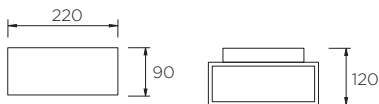
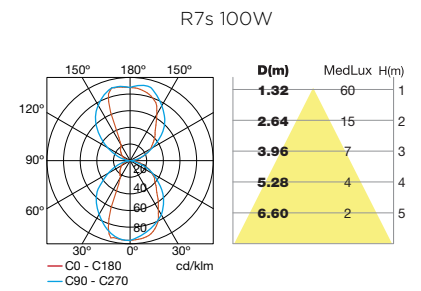
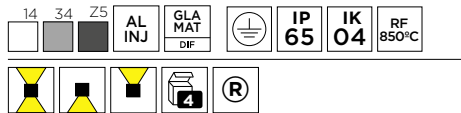

AFRODITA

05-9230-14-37



05-9230-34-37



05-9230-J6-37



05-9230-Z5-37



G24d-3 26W Fluor | A**... B

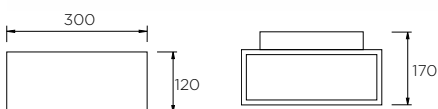
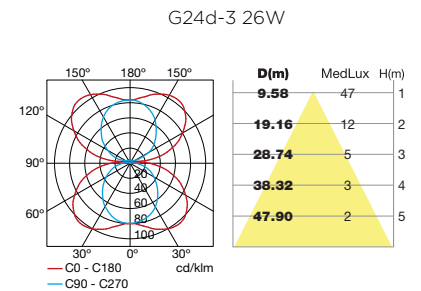
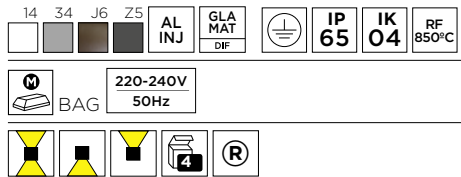

AFRODITA

05-9438-34-37



05-9438-Z5-37



Rx7s 70W HID | A*... A

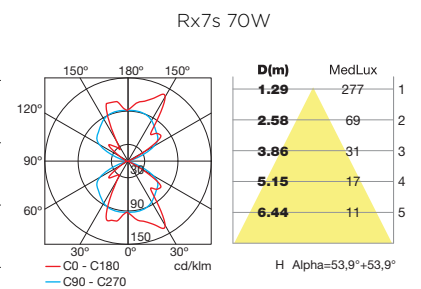
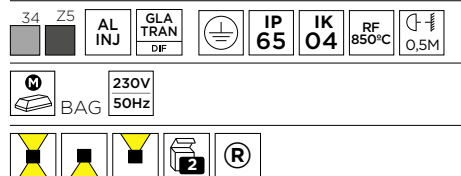



OUTDOOR | WALL FIXTURES

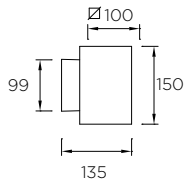

AFRODITA

05-9773-34-37V1

05-9773-Z5-37V1

Led CREE 17,4W | 3000K | 1296lm | **A**... A**

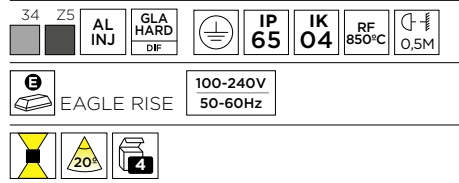

Led 17,4W 3000K

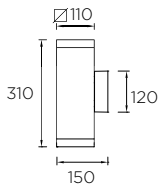
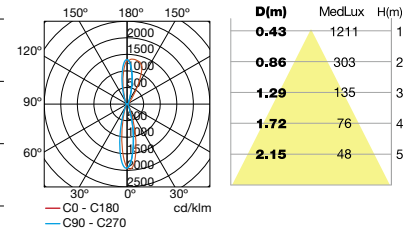

AFRODITA

05-9368-14-37

05-9368-34-37

05-9368-Z5-37

2 x Par-30 E27 max. 75W | max. L 100mm
Hal - Fluo | **A**... C**

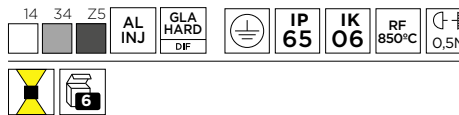

2 x Par-30 75W

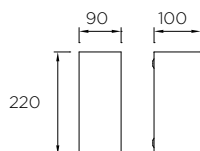
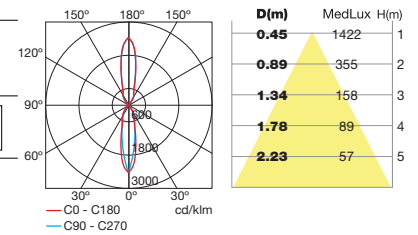

ALVIN

05-9725-34-T2

05-9725-Z5-T2 NEW

2 x GU-10 max. 35W | max. L 70mm
Hal - Fluo | **A**... C**

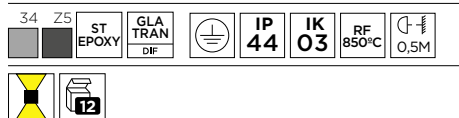

GU-10 50W

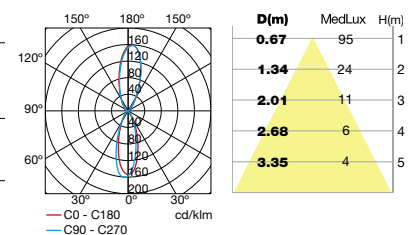

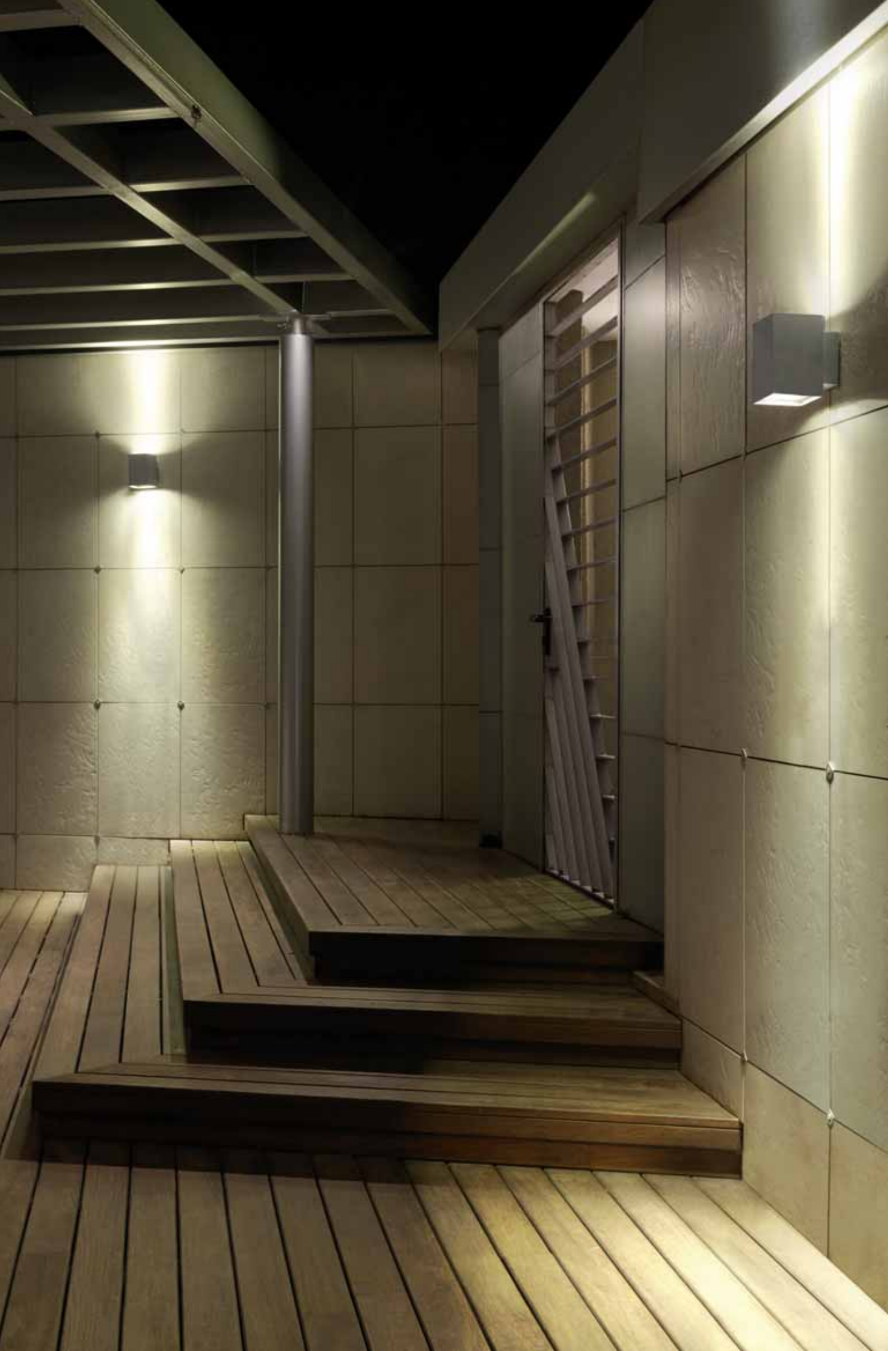

OUTDOOR | WALL FIXTURES



AFRODITA

05-9577-34-37



05-9577-Z5-37



G12 HID 70W | A+... A

34	Z5	AL PUR	GLA HARD DIF	⊕	IP 65	IK 08	RF 850°C	0,5M
M BAG		220-240V 50Hz						
80°		2		R				

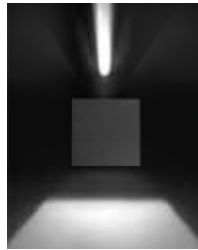
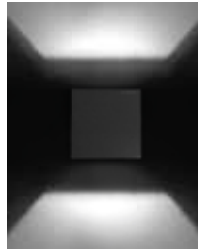
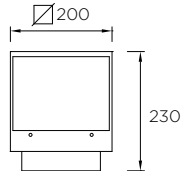
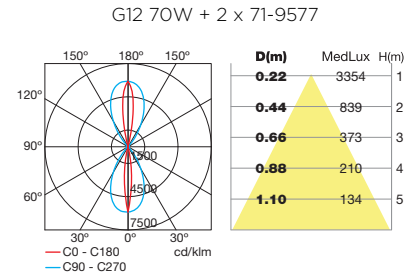

71-9577-05-37



Lente para / Lens for / Lentille pour / Linse für / Lente per / Lente para / Линза для / Soczewka dla 05-9577

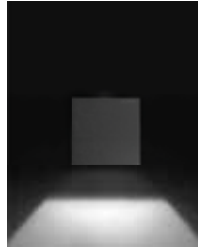
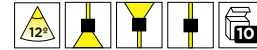

71-9875-05-05



Reflector direccional para / Directional reflector for / Réflecteur directionnel pour / Reflektor für / Riflettore direzionale per / Reflektor direccional para / Направленный отражатель для / Odbłyśnik kierunkowy dla 05-9577

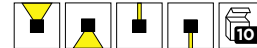

AFRODITA

05-9369-34-37



05-9369-Z5-37



G12 70W HID | A+... A

34	Z5	AL INJ	GLA HARD DIF	⊕	IP 65	IK 08	RF 850°C	0,5M
M BAG		220-240V 50Hz						
2		2		R				

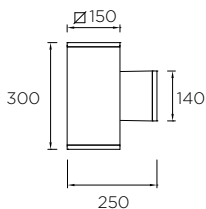
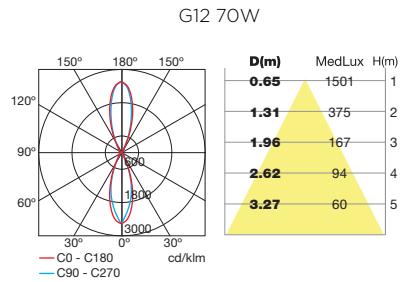

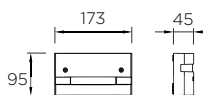

FINESTRA NEW

10-9903-34-CM

Led CREE 4,2W | 4000K | 446lm | A**... A

34	AL PUR	PC TRAN DIF		IP 65	RF 850°C
EAGLE RISE			110-240V 50-60Hz		
	17°x106°	1,5 m	FILTER 3000K		



OUTDOOR | WALL FIXTURES

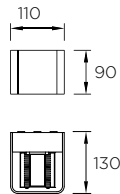

WILSON

05-9683-14-CLV1

05-9683-Z5-CLV1

Led 9W | 3000K | 855lm | A**... A

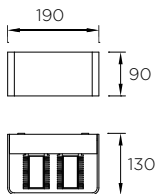
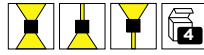

WILSON

05-9684-14-CLV1 **NEW**

05-9684-Z5-CLV1

Led 18W | 3000K | 1710lm | A**... A

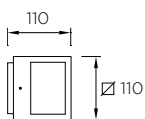

POKER

05-9732-34-CMV1

05-9732-Z5-CMV1

Led PHILIPS 8,1W | 4000K | 756lm | A**... A





OUTDOOR | WALL FIXTURES

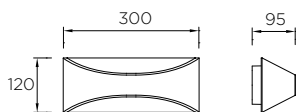

VENUS NEW

05-9894-14-CL

05-9894-Z5-CL

Led CREE 10W | 3000K | 759lm | A**... A

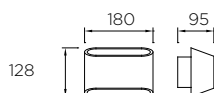
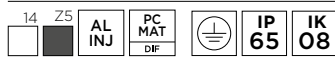

DIAGO



05-9873-Z5-CLV1

Led SHARP 10W | 3000K | 810lm | A**... A

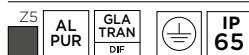

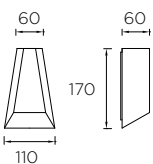

TAYLOR

05-9592-34-37 4000K | 214lm

05-9592-34-CL 3000K | 188lm

2 Led CREE 2W | A**... A

34	AL INJ	GLA TRAN DIF	IP 44	RF 850°C	0,2M
	100-240V 50-60Hz				

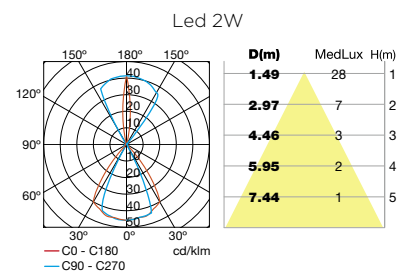

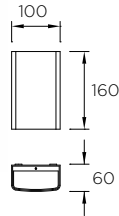

CLOUS

05-9679-34-B8

05-9679-Z5-B8

Led CREE 6W | 3000K | 564lm | A++... A

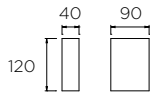
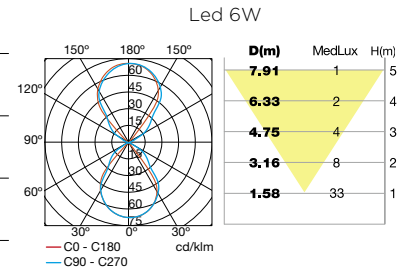

TAYLOR

05-9593-14-CM **NEW**

05-9593-34-37

Led CREE 4,5W | 4000K | 368lm | A++... A

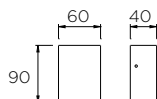
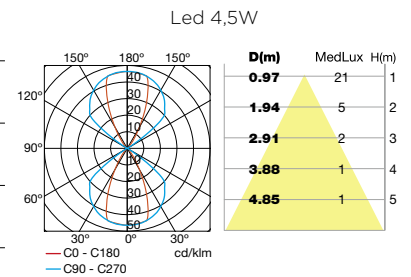
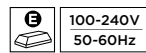

TAYLOR

05-9594-14-37

05-9594-34-37

Led CREE 2,2W | 4000K | 184 lm | A++... A

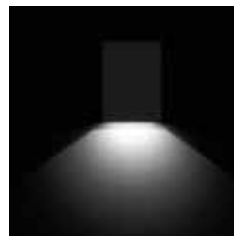
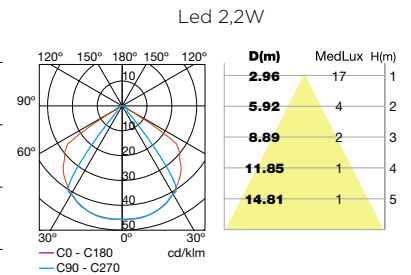
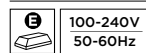

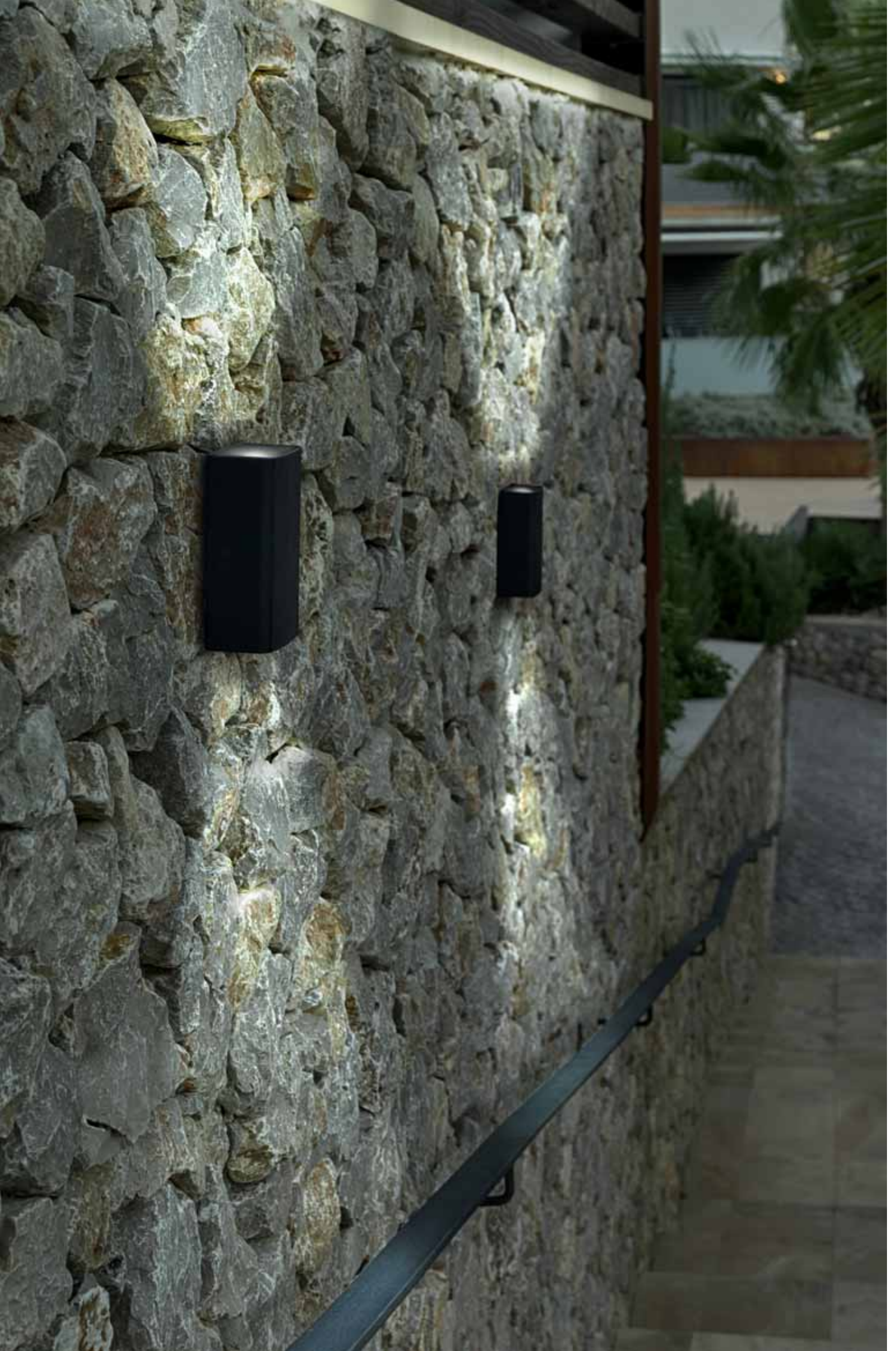

OUTDOOR | WALL FIXTURES



NEMESIS

- 05-9649-14-T2
- 05-9649-34-T2
- 05-9649-J6-T2 **NEW**
- 05-9649-Z5-T2

E27 max. 60W | max. L 155mm
Hal - Fluo | **A**... C**

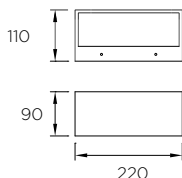

E27 60W

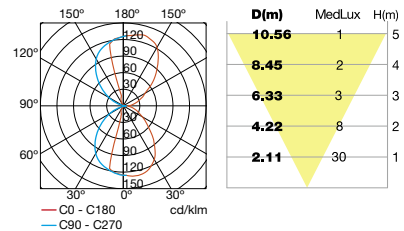

NEMESIS

- 05-9177-14-B8
- 05-9177-34-B8
- 05-9177-J6-B8
- 05-9177-Z5-B8

R7s L=78 max. 100W | **A**... C**

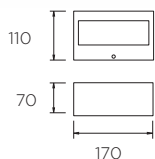
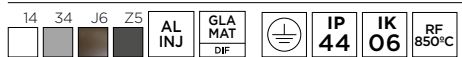

R7s 100W

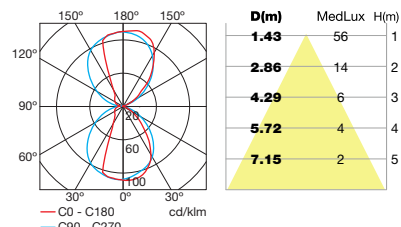

NEMESIS



- 05-9629-CA-B8

R7s L=78 max. 100W Hal | **A**... C**

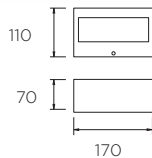
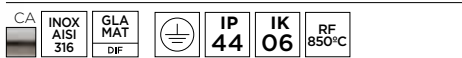

R7s 100W

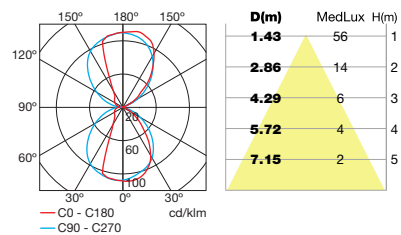

FLUO KIT

71-8969-00-00

G24d-1 13W Fluo | **A**... B**

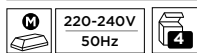

Accesorio para / Accessory for / Accessoire pour / Zubehör für / Accessorio per / Acessório para / Принадлежность для / Akcesorium do 05-9177, 05-9629



LED KIT

71-9781-00-00

Led SAMSUNG 5,3W | 4000K | 679lm | **A**... A**



Accesorio para / Accessory for / Accessoire pour / Zubehör für / Accessorio per / Acessório para / Принадлежность для / Akcesorium do 05-9177, 05-9629

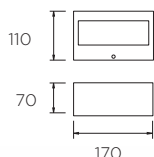

NEMESIS

- 05-9800-14-CL
- 05-9800-34-CL
- 05-9800-J6-CL
- 05-9800-Z5-CL

Led SAMSUNG 5,3W | 3000K | 644 lm | A**... A

14	34	J6	Z5	AL INJ	GLA MAT DIF	IP 44	IK 06	RF 850°C
E SELF		100-240V						
		50-60Hz						

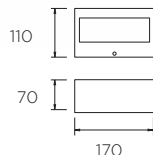

NEMESIS



- 05-9905-CA-CL

Led SAMSUNG 5,3W | 3000K | 644 lm | A**... A

CA	INOX AISI 316	GLA MAT DIF	IP 44	IK 06	RF 850°C
E SELF		100-240V			
		50-60Hz			

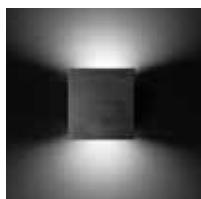
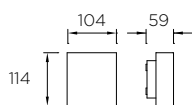

NEMESIS

- 05-9753-CA-CLV1

Led SAMSUNG 6,6W | 3000K | 653lm | A**... A

CA	INOX AISI 316	AL INJ	PC MAT DIF	IP 54	IK 07
E EAGLE RISE		100-240V			
		50-60Hz			

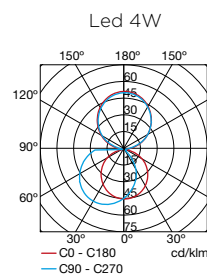

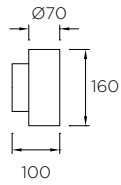

TERRY

05-9719-34-37

05-9719-Z5-CM NEW

Led CREE 4,5W | 4000K | 368lm | A**... A



Led 4,5W

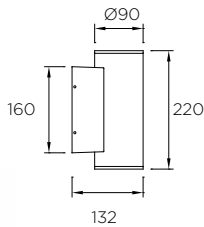
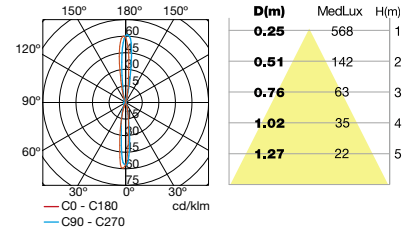

COSMOS

05-9790-34-CL

05-9790-Z5-CL

Led CREE 27W | 3000K | 2040lm | A**... A



Led 27W

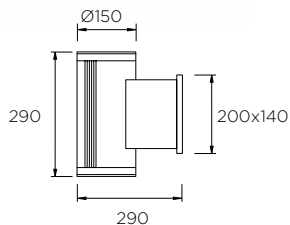
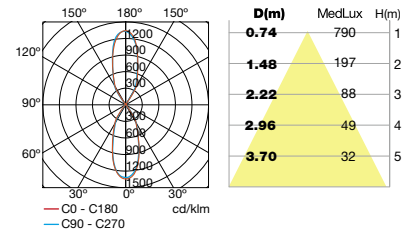

AFRODITA

05-9204-34-B8

G12 70W HID | A*... A



G12 70W

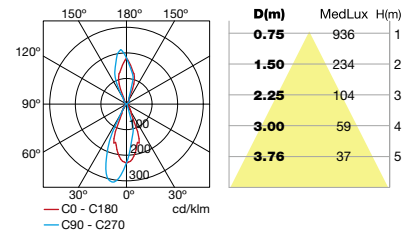



OUTDOOR | WALL FIXTURES



NAPOLI

05-9735-34-M1

E27 max. 23W | max. L 180mm
Hal - Fluo | A++... C

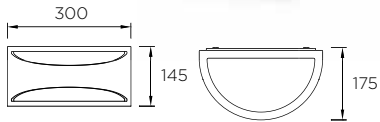
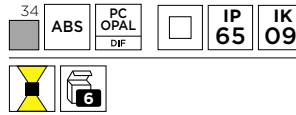

E27 23W

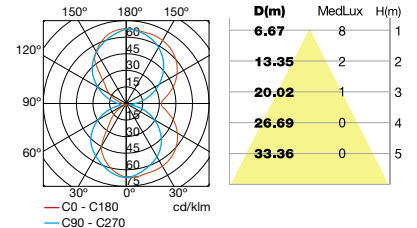

ATENA

05-9131-34-M3

05-9131-Z5-M3

E27 max. 60W | max. L 167mm Ø 51mm
Hal - Fluo | A++... C

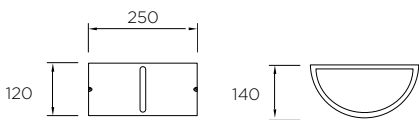
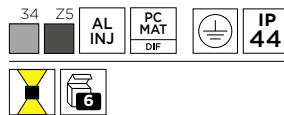

E27 60W

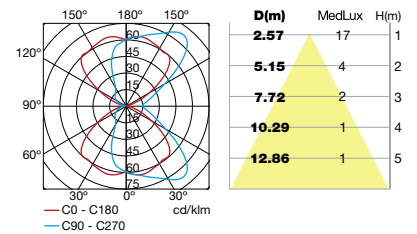

NEMESIS

05-9123-34-B8

05-9123-Z5-B8

E27 max. 60W | max. L 117mm Ø 45mm
Hal - Fluo | A++... C

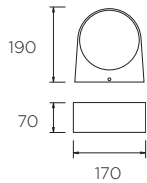

E27 15W

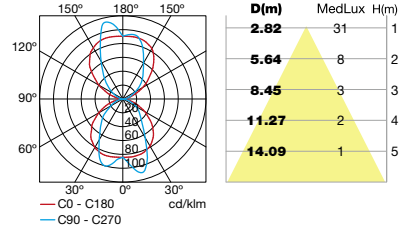

SELENE

05-9234-18-37

05-9234-34-37

2 x GU-10 max. 35W | max. L 65mm
Hal - Fluo | A++... C



GU-10 35W

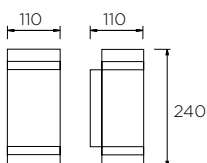
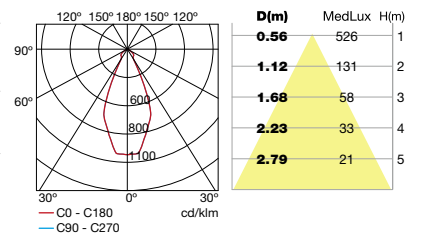

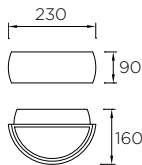

DELFO

05-9650-34-T2 ■

E27 max. 60W | max. L 130mm
Hal - Fluo | A**... C

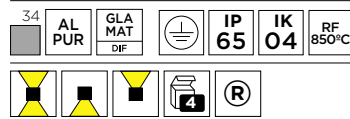



CURIE

05-9662-34-CD

T5 28/54W Fluo | A++... B



T5 28W

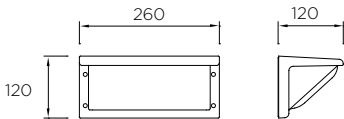
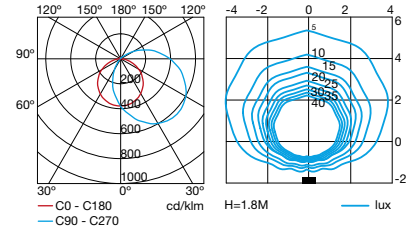

CURIE

05-9408-34-M3

05-9408-Z5-M3

G24d-3 26W Fluo | A++... B



G24d-3 26W

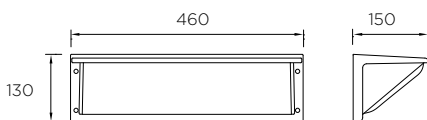
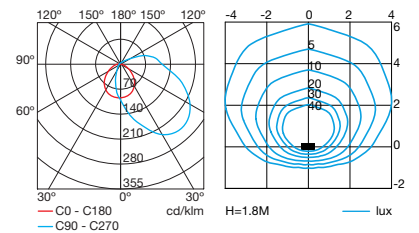

CURIE

05-9457-34-M3

05-9457-Z5-M3

2 x G24d-3 26W Fluo | A++... B

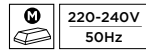
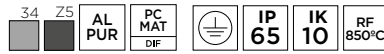

2 x G24d-3 26W

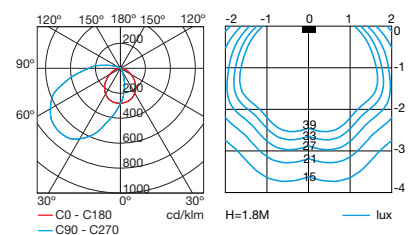



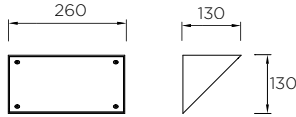

CURIE NEW

05-9884-14-G5

05-9884-Z5-G5

E27 max. 60W | max. L 140mm
Fluo | A**... C



E27 16W

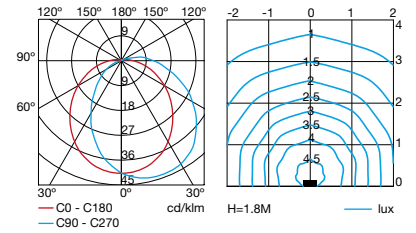

LED KIT NEW

71-9884-00-CM 4000K | 1604lm

71-9884-00-CL 3000K | 1443lm

Led 14W | A**... A



Accesorio para / Accessory for / Accessoire pour / Zubehör für / Accessorio per / Acessório para / Принадлежность для / Akcesorium do 05-9884

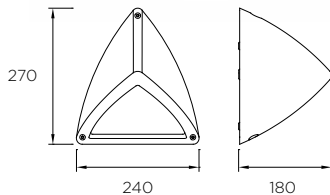

PIRAMID

05-9559-34-B8

E27 max. 23W | max. L 140mm
Fluo | A**... C



E27 23W

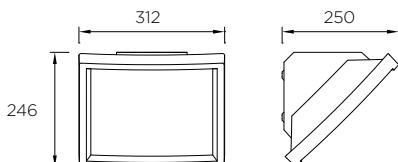
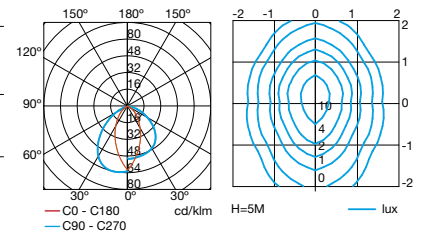

ACCESS

05-9734-14-M1 NEW

05-9734-34-M1

2 x E27 max. 18W | max. L 160mm
Fluo | A**... C

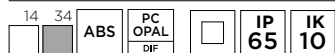

2 X E27 18W

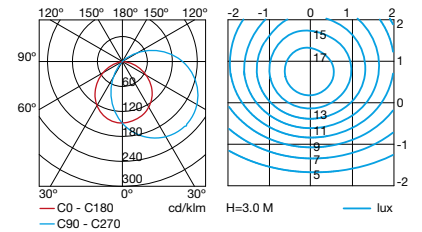



OUTDOOR | WALL FIXTURES

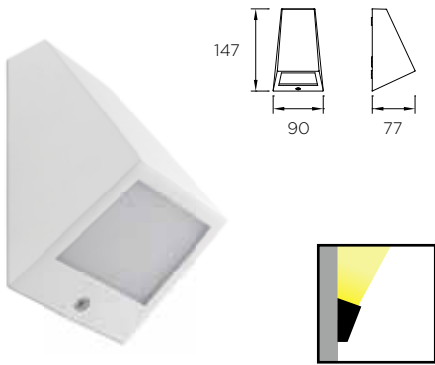

ANGLE

05-9836-14-CL NEW

05-9836-34-CL

Led SAMSUNG 3W | 3000K | 358lm | A**... A

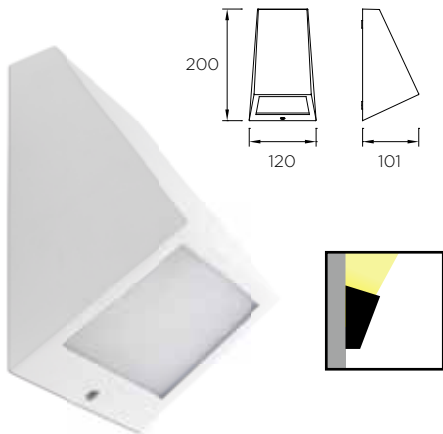
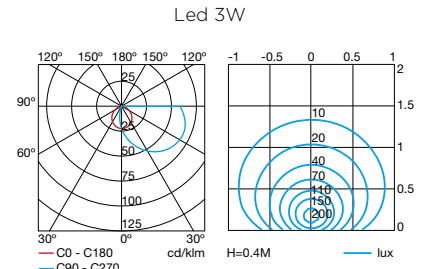
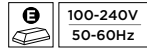
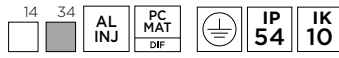

ANGLE

05-9837-14-CL NEW

05-9837-34-CL

Led SAMSUNG 10,6W | 3000K | 1288lm | A**... A

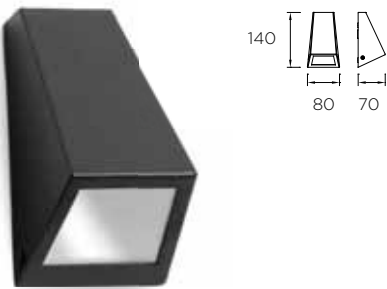
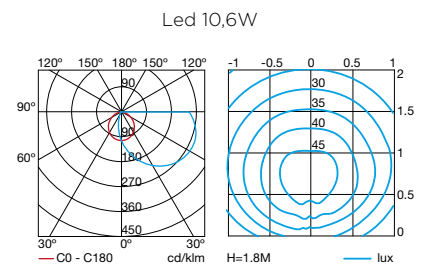
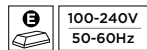
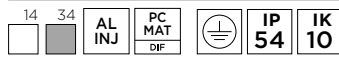

ANGLE

05-9565-Z5-B8 (S)

GU-10 max. 35W | max. L 70mm
Hal - Fluo | A**... C

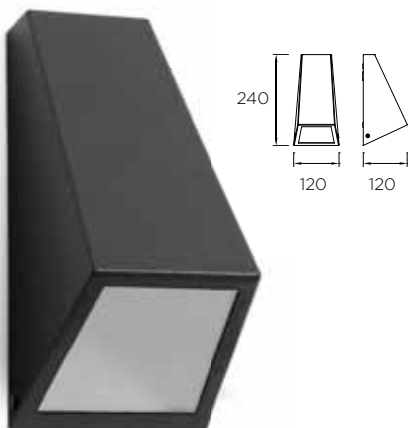
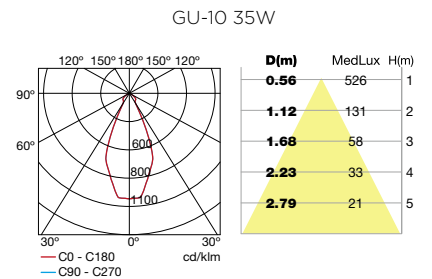
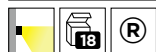

ANGLE

05-9566-Z5-B8 (S)

E27 max. 60W | max. L 170mm
Hal - Fluo | A**... C

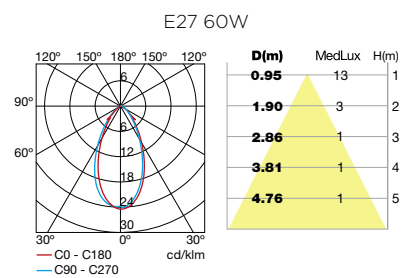
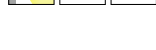



CUBUS

05-9685-14-CL



NEW

05-9685-Z5-T2



Led 5W



Led CREE 5W | 3000K | 470lm | A**... A

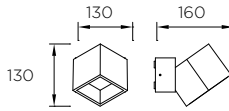
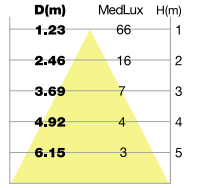
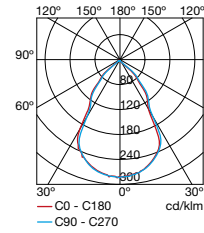
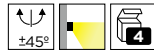

HAMMER

05-9871-Z5-37



GU-10 max. 35W | max. L 70mm
Hal - Fluo | A**... C

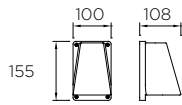

ICARO

05-9190-34-37



GU-10 max. 50W | max. L 75mm
Hal - Fluo | A**... C



GU-10 50W

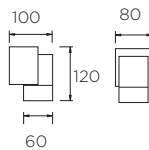
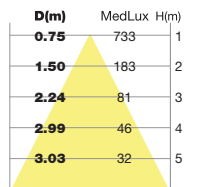
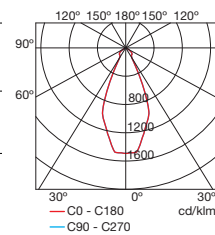

ICARO

05-9191-34-37



2 x GU-10 max. 50W | max. L 75 mm
Hal - Fluo | A**... C



GU-10 50W

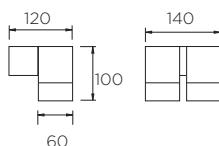
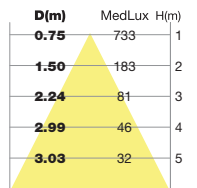
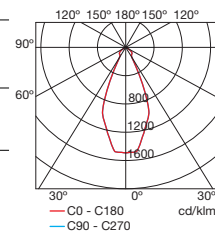





CORNER

05-9687-14-M1

Led 2,5W | 3000K | 250lm | A**... A

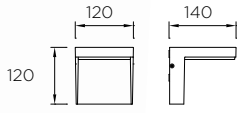

14	AL INJ	PC OPAL DIF	IP 54	RF 850°C
E	110-230V	50-60Hz		



ALFA

05-9344-J6-T2

GU-10 max. 50W | max. L 65mm
Hal - Fluo | A**... C

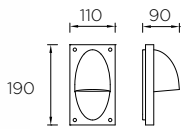

J6	AL PUR	GLA TRAN DIF	IP 54	IK 07	RF 850°C	0,5M
E	6	R				

GU-10 50W

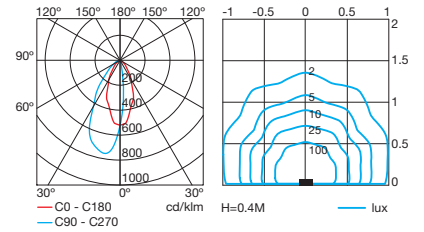

SURF

05-9483-34-CL

Led CREE 2,3W | 3000K | 142lm | A**... A

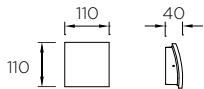

34	AL INJ	GLA TRAN DIF	IP 64	IK 08	RF 850°C
E	EAGLE RISE	100-240V	50-60Hz		

Led 2,3W

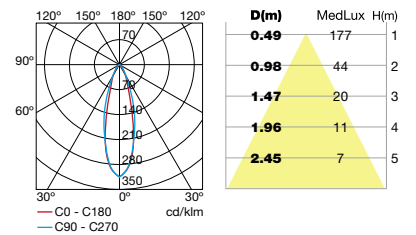

SURF

05-9484-34-CL

Led CREE 4,6W | 3000K | 284lm | A**... A

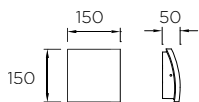

34	AL INJ	GLA TRAN DIF	IP 64	IK 08	RF 850°C
E	EAGLE RISE	100-240V	50-60Hz		

Led 4,6W

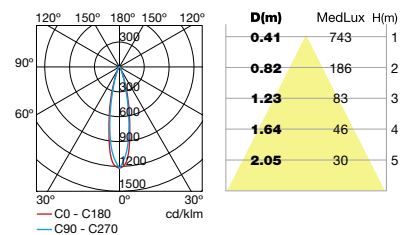



OUTDOOR | WALL FIXTURES



KÖSSEL

05-9814-14-CMV1 + +

Led 3W | 4000K | 292lm | A**... A

14	PC	ABS	PC TRAN DIF	IP 65	IK 10
----	----	-----	-------------	-------	-------

E	100-240V
	50-60Hz

		FILTER 3000K	
--	--	--------------	--

P. 566

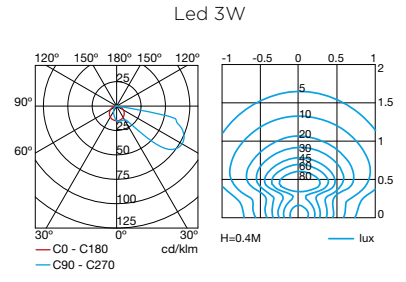
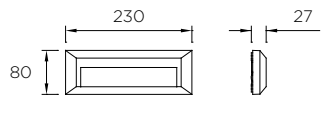

KÖSSEL

05-9802-14-CMV1 + +

Led 1,5W | 4000K | 130lm | A**... A

14	PC	ABS	PC TRAN DIF	IP 65	IK 10
----	----	-----	-------------	-------	-------

E	100-240V
	50-60Hz

		FILTER 3000K	
--	--	--------------	--

P. 566

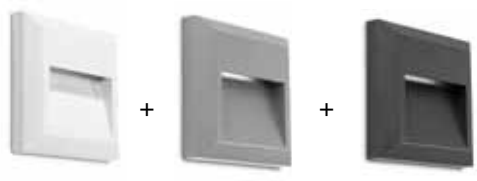
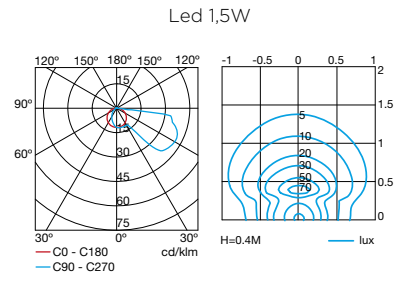
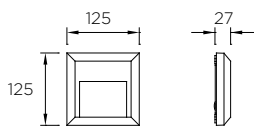

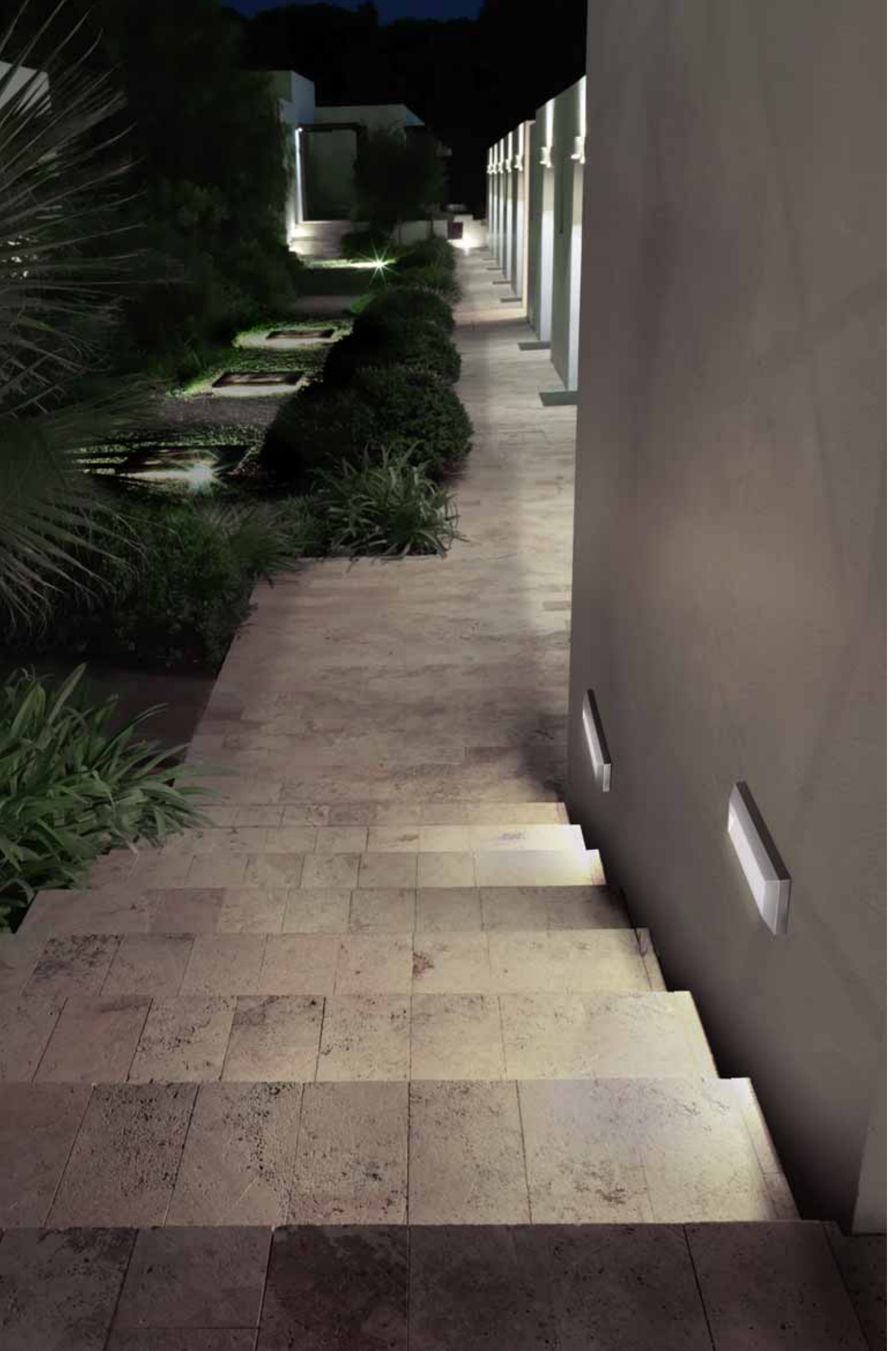

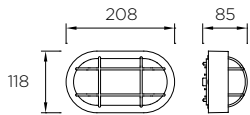

TURTLED NEW

05-9838-14-CMV1 + 4000K | 779lm

05-9838-14-CLV1 + 3000K | 701lm

Led 7,5W | A**... A

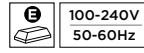
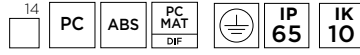

KÖSSEL

05-9779-34-CMV2 + + 4000K | 440lm NEW

05-9779-34-CLV2 + + 3000K | 396lm

Led 4W | A**... A

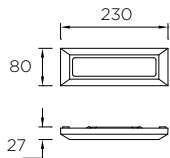
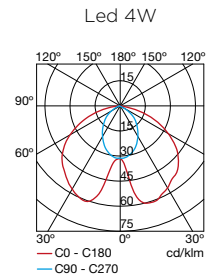
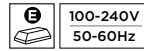

LOTTERY

05-9726-Z5-37

Led 3,4W | 4000K | 378lm | A**... A



Led 3,4W

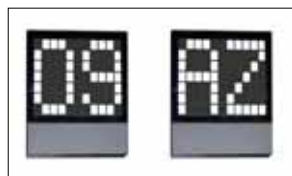
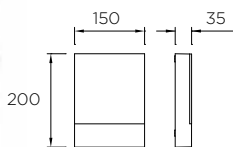
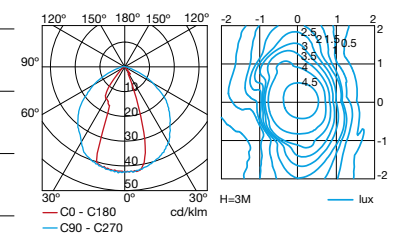

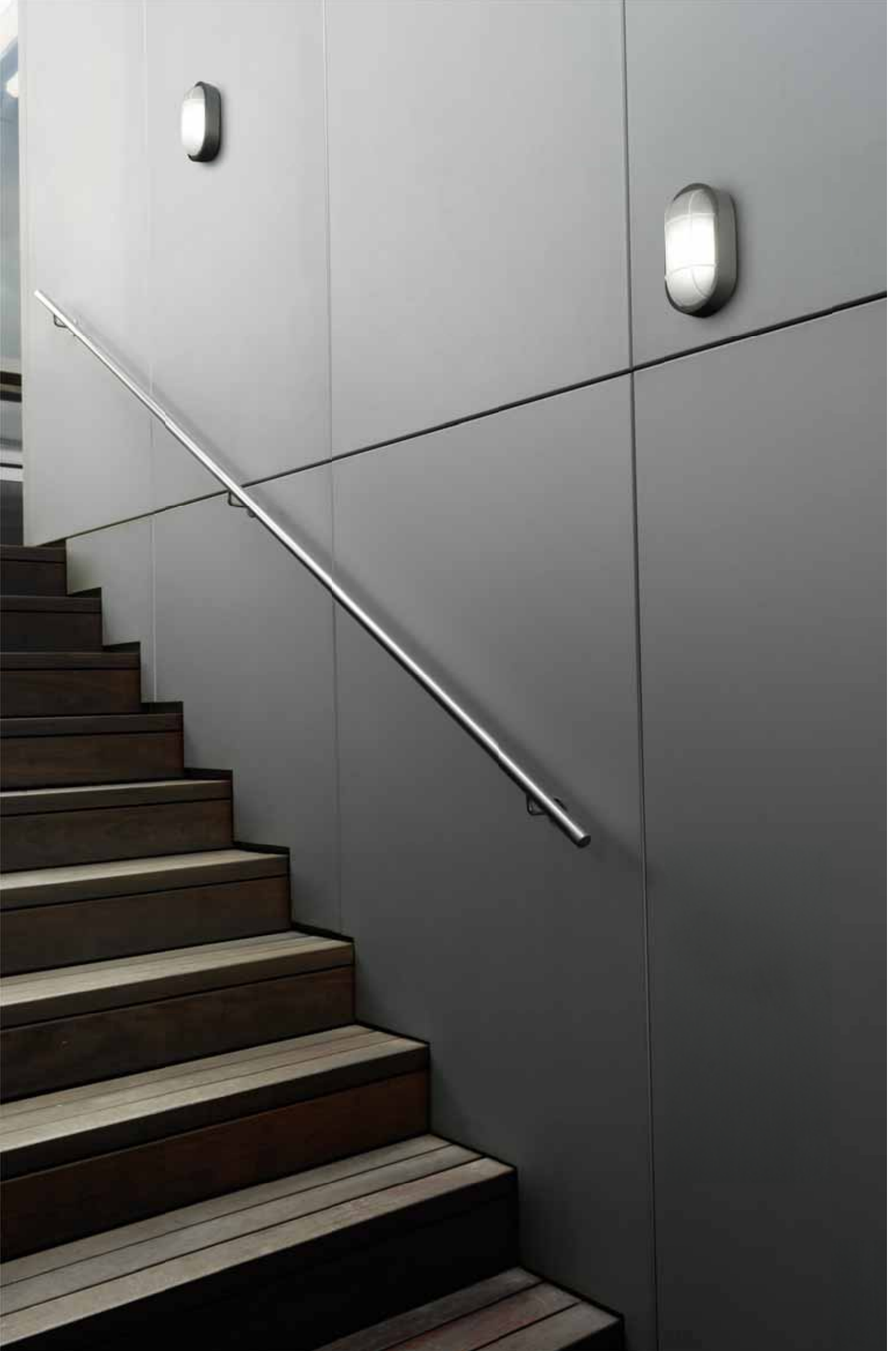

OUTDOOR | WALL FIXTURES

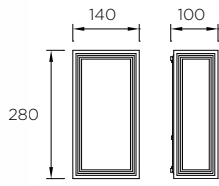

THOMAS

05-9686-Z5-M1 ■

E27 max. 23W | max. L 180mm
Fluo | A++... C

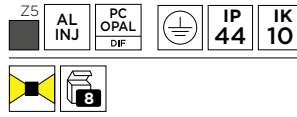

E27 23W

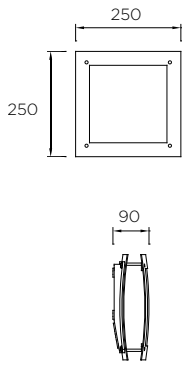
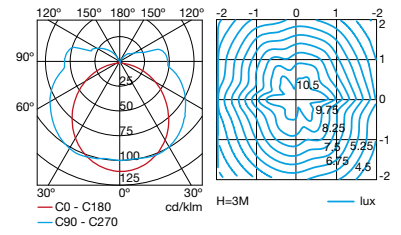

DARWIN

05-9444-Z5-CD ■

E27 max. 23W | max. L 180mm Ø 60mm
Fluo | A++... C

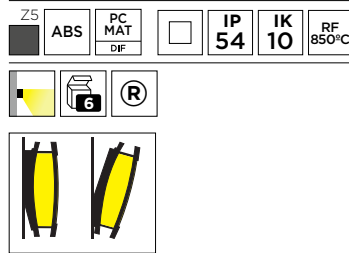

E27 23W

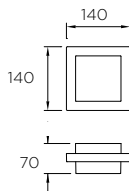
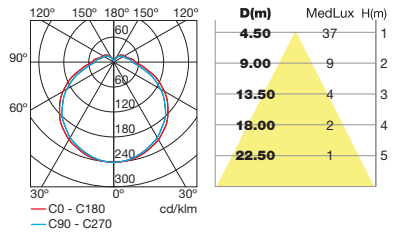

JEP

15-9688-34-M1 ■

25 Led 3,5W | 3000K | 370lm | A++... A

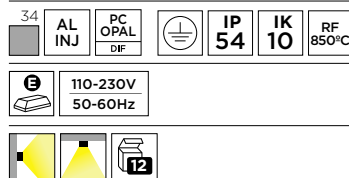

Led 3,5W

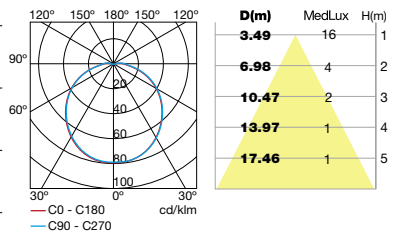

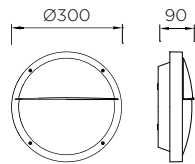

OPAL

05-9677-14-M1

2 x E27 max. 23W | max. L 165mm
Fluo | A**... C



LED KIT

71-9711-00-00V1 4000K | 1488lm

71-9712-00-00V1 3000K | 1340lm

Led 14,5W



Accesorio para / Accessory for / Accessoire pour
/ Zubehör für / Accessorio per / Acessório para /
Принадлежность для / Akcesorium do 05-9677

Led 14,5W 4000K

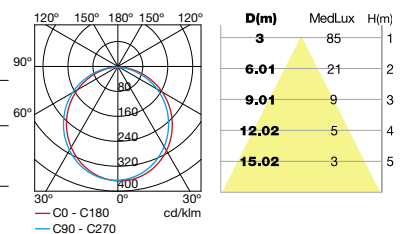

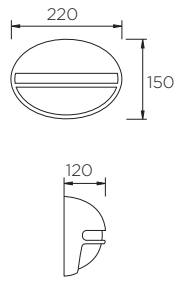

ZEUS

05-8751-34-M3 ■

05-8751-05-M3 ■

E27 max. 60W | max. L 100mm Ø 45mm
Hal - Fluo | **A+... C**

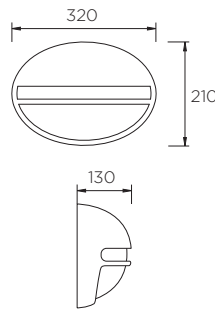
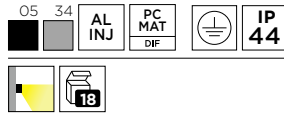

ZEUS

05-8729-34-M3 ■

05-8729-05-M3 ■

E27 max. 100W | max. L 167mm
Hal - Fluo | **A+... C**

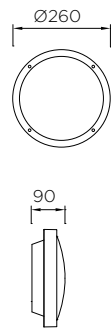
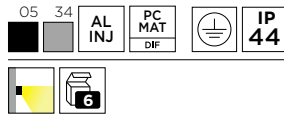

BASIC ALUMINIUM

15-9835-34-M1 ■

E27 max. 23W | max. L 165mm Ø 55mm
Fluo | **A+... C**

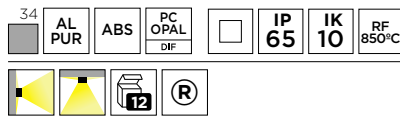

E27 18W

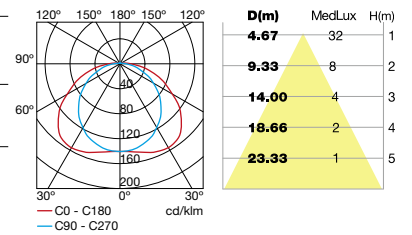

LED KIT

71-9711-00-00V1 4000K | 1488lm

71-9712-00-00V1 3000K | 1340lm

Led 14,5W



Accesório para / Accessory for / Accessoires pour / Zubehör für / Accessorio per / Acessório para / Принадлежность для / Akcesorium do 15-9835

Led 14,5W 4000K

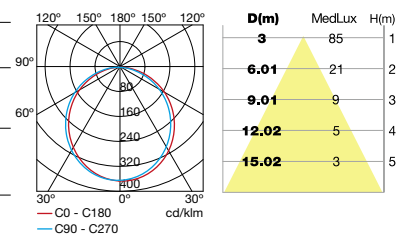

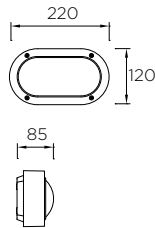

BASIC ALUMINIUM NEW

05-9886-34-M1 ■

E27 max. 16W | max. L 145mm Ø 50mm
Fluo | **A++... C**

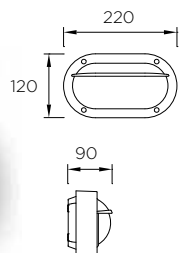

BASIC



05-9544-Z5-M3 ■

E27 max. 16W | max. L 145mm Ø 50mm
Fluo | **A++... C**

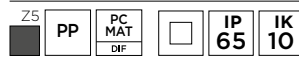

E27 16W

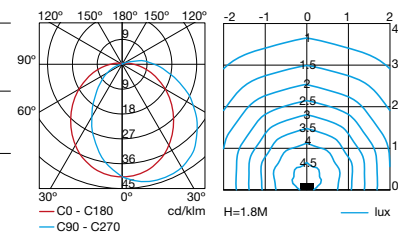

LED KIT NEW

71-9886-00-CM 4000K | 900lm

71-9886-00-CL 3000K | 810lm

Led 7,5W



Accesorio para / Accessory for / Accessoire pour / Zubehör für / Accessorio per / Acessório para / Принадлежность для / Akcesorium do 05-9544, 05-9886



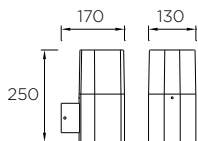

MANDELA

05-9605-Z5-M1 ■

E27 max. 23W | max. L 150mm
Fluo | A**... C

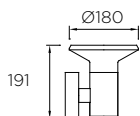
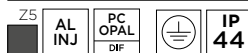

SPACE

05-9872-Z5-CL ■

Led SHARP 7,5W | 3000K | 650lm | A**... A

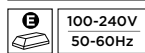
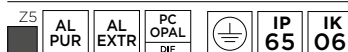

Led 7,5W

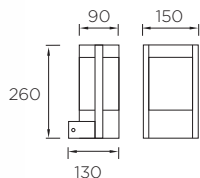
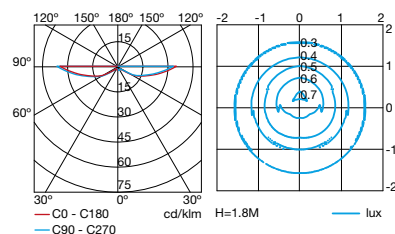

HEBE

05-9238-34-M3 ■

E27 max. 100W | max. L 167mm
Hal - Fluo | A**... C

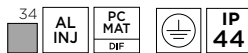

E27 30W

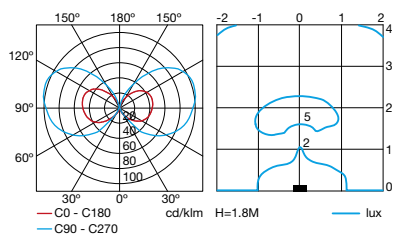

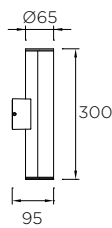

MONACO

05-9780-34-M1

Led 7W | 3000K | 600lm | A**... A

34	AL INJ	DC OPAL DIF		IP 54	IK 06
	100-240V 50-60Hz				



Led 7W

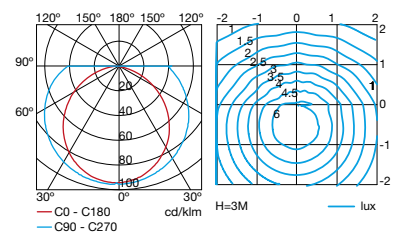



AJAX

05-9207-Y4-M1

E27 max. 60W | max. L 140mm Ø 70mm
Hal - Fluo | A++... C

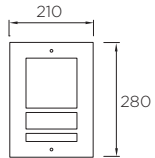
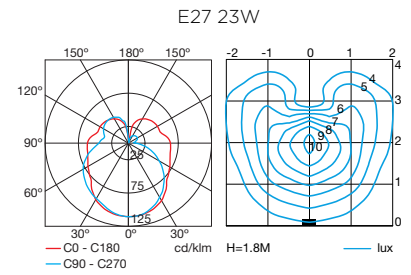

NEREO

05-8796-Y4-M1

E27 max. 23W | max. L 167mm Ø 51mm
Fluo | A++... C

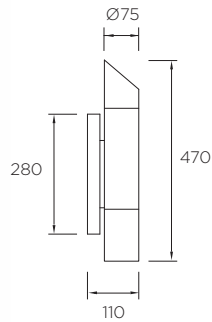

ELECTRA

05-8790-Y4-M1

E27 max. 23W | max. L 167mm Ø 55mm
Fluo | A++... C

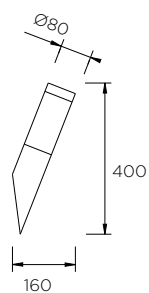
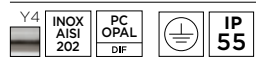

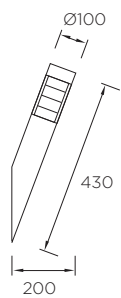











PRIAP

05-9239-CA-M2 

E27 max. 23W | max. L 152mm Ø 50mm
Fluo | **A**... C**

 CA	 INOX AISI 316	 PC TRAN DIF		 IP 54	 IK 06
					

 P 626, 627

E27 23W

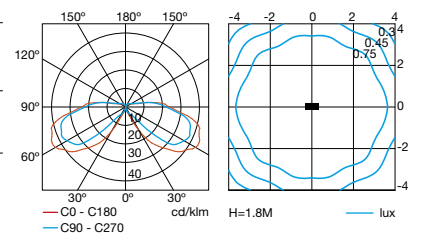

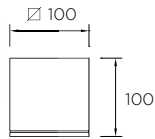

AFRODITA

15-9680-34-37

4 Led CREE 9W | 4000K | 736lm | A**... A

34	AL INJ	GLA DIF	IP 65	IK 04	RF 850°C
EAGLE RISE			100-240V 50-60Hz		
20°		DIFFUSER FILTER	B		R

Led 9W

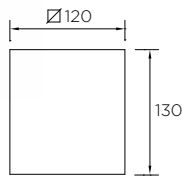
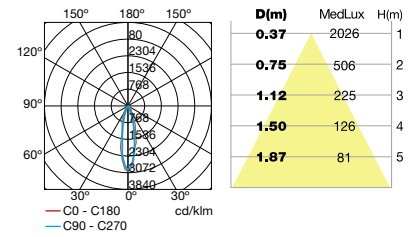

AFRODITA

15-9558-CA-B8

Par-20/30 E27 max. 50W | max. L 98mm Ø 97mm
Hal - Fluo | A**... C

CA	INOX AISI 316	GLA MAT DIF	IP 23	IK 05	RF 850°C	0,5M
SEA SIDE SUITABLE		B		R		

Par-30 50W

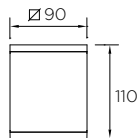
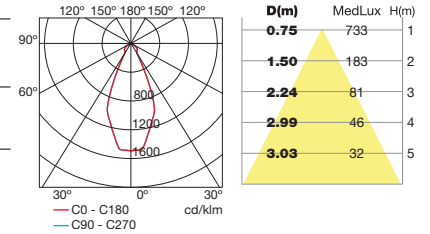

AFRODITA

15-9480-34-37

15-9480-Z5-37

GU-10 max. 35W | max. L 75mm
Hal - Fluo | A**... C

34	Z5	AL INJ	GLA TRAN DIF	IP 54	IK 05	RF 850°C
0,5M		B		R		

GU-10 35W

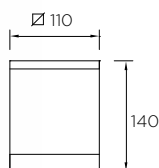
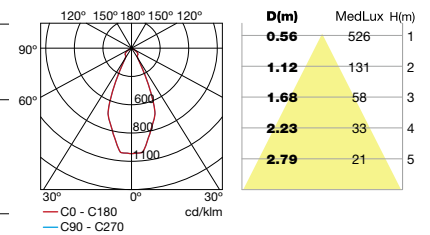

AFRODITA

15-9328-34-B8

15-9328-Z5-B8

Par-30 E27 max. 75W | max. L 90mm Ø 97mm
Hal - Fluo | A**... C

34	Z5	AL INJ	GLA TRAN DIF	IP 54	IK 05	RF 850°C
0,5M		B		R		

Par-30 75W

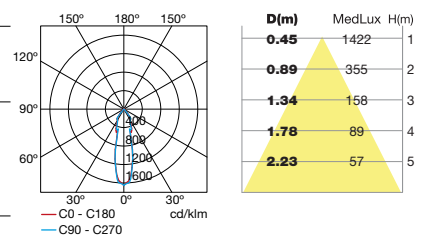

CEILING



OUTDOOR | CEILING



PREMIUM

15-9839-05-CL ■

Led SAMSUNG 38W | 3000K | 4991lm | A**... A

05	PC	PC MAT GRF		IP 65	IK 10
	MEANWELL		100-240V 50-60Hz		

Led 38W

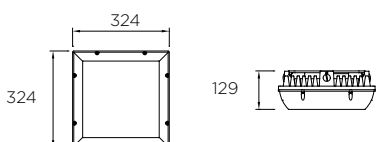
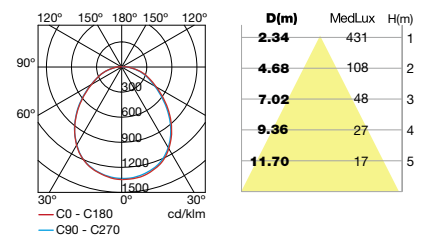



SOLID NEW

15-9900-34-CM

Led 17,5W | 4000K | 2268lm | A**... A

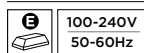
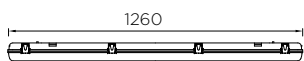

SOLID

15-9901-34-CM

Led 43W | 4000K | 5508lm | A**... A

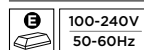
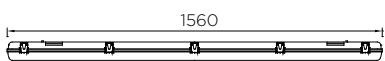

AFRODITA

15-9561-34-37

T5 54W Fluo | A**... B

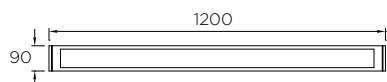

T5 54W

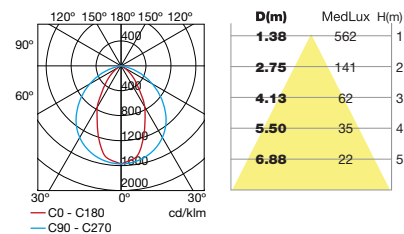



OUTDOOR | CEILING

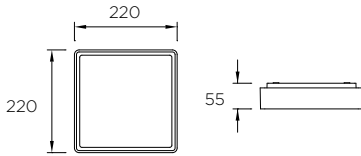

KÖSSEL

15-9778-34-CLV1

Led 6,5W | 3000K | 644lm | A**... A

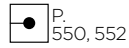

Led 6,5W

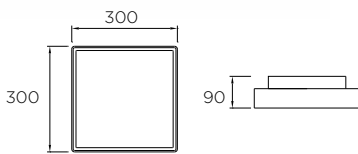
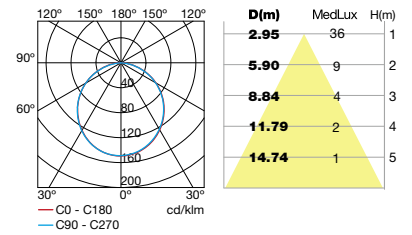

KÖSSEL

15-9619-34-M1

2 x E27 max. 18W | max. L 160mm Ø 50mm
Fluo | A**... C

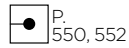
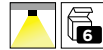

2 x E27 18W

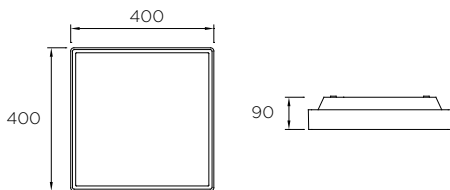
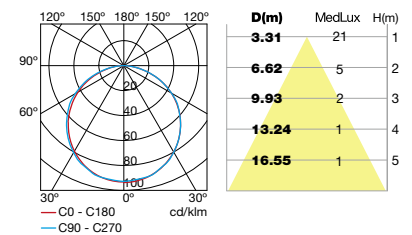

KÖSSEL

15-9806-34-CL

Led 19W | 3000K | 2268lm | A**... A

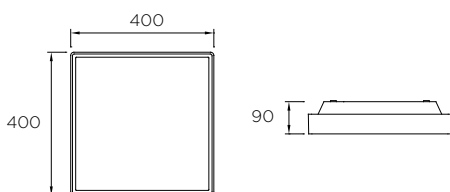
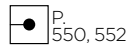

KÖSSEL

15-9807-34-M1

2 x E27 max. 23W | max. L 190mm Ø 50mm
Hal - Fluo | A**... C





OUTDOOR | CEILING

COSMOS

15-9790-34-CL



15-9790-Z5-CL



Led 12W

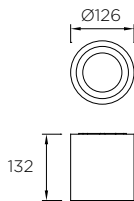

Led CREE 12W | 3000K | 1290lm | A**... A

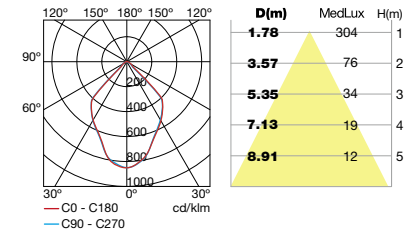

COSMOS

15-9362-34-37



15-9362-Z5-37



Par-30 75W

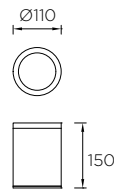

Par-30 E27 max. 75W | max. L 90mm Ø 97mm
Hal - Fluo | A**... C

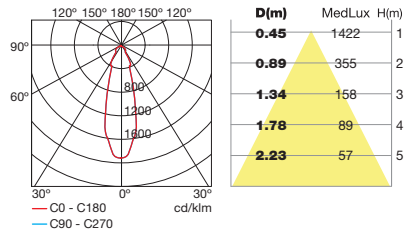

COSMOS

15-9365-34-T2



15-9365-Z5-T2



2 x GX24d-3 26W

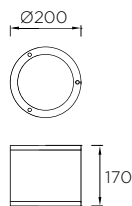

2 x GX24d-3 26W Fluo | A**... B

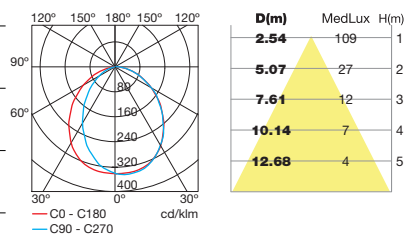

SELENE

15-9234-34-37



GU-10 35W

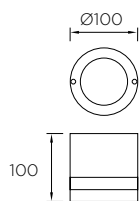

GU-10 max. 35W | max. L 70mm
Hal - Fluo | A**... C

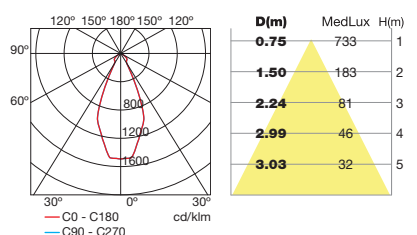



OUTDOOR | CEILING

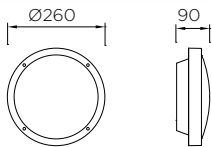

BASIC

15-9491-34-M3

E27 max. 23W | max. L 165mm Ø 55mm
Fluo | A**... C



E27 18W

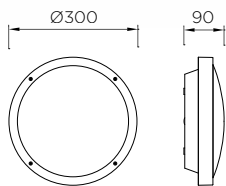
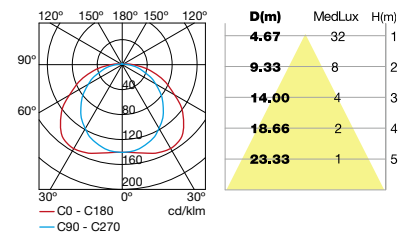

BASIC

15-9493-34-M3

2 x E27 max. 23W | max. L 165mm Ø 55mm
Fluo | A**... C

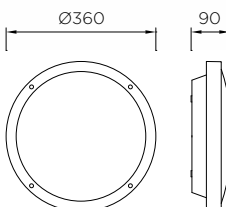
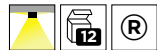

BASIC

15-9542-34-M3

2 x E27 max. 23W | max. L 180mm
Fluo | A**... C



LED KIT

71-9711-00-00V1 4000K | 1488lm

71-9712-00-00V1 3000K | 1340lm

Led 14,5W



Accesorio para / Accessory for / Accessoire pour / Zubehör für / Accessorio per / Acessório para / Принадлежность для / Akcesorium do 15-9835, 15-9542, 15-9493, 15-9491.

Led 14,5W 4000K

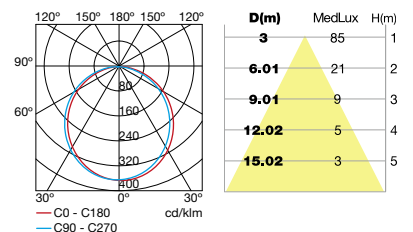

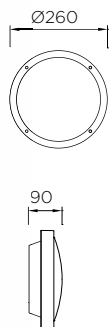

BASIC ALUMINIUM

15-9835-34-M1 ■

E27 max. 23W | max. L 165mm Ø 55mm
Fluo | A++... C

34	AL PUR	ABS	PC OPAL DIF	□	IP 65	IK 10
RF 850°C						



□ P
556, 557

E27 18W

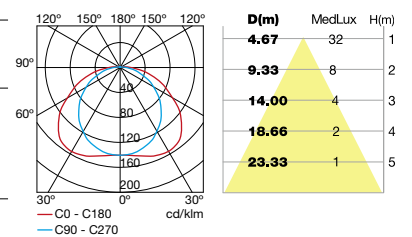

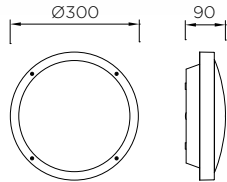

OPAL

15-9677-14-M1

2 x E27 max. 23W | max. L 165mm Ø 55mm
Fluo | A+... C

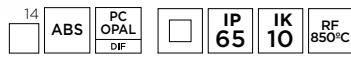

2 x E27 23W

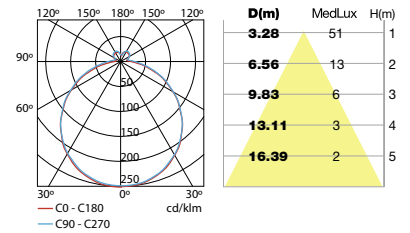

LED KIT

71-9711-00-00V1 4000K | 1488lm

71-9712-00-00V1 3000K | 1340lm

Led 14,5W



Led 14,5W 4000K

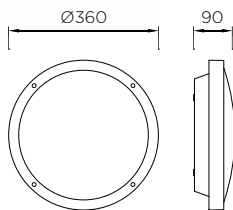
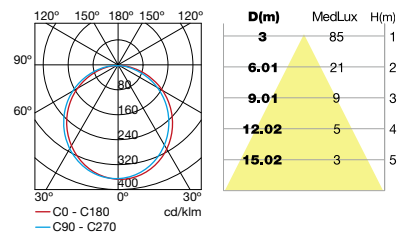

OPAL

15-9678-14-M1

2 x E27 max. 42W | max. L 180mm Ø 55mm
Hal - Fluo | A+... C

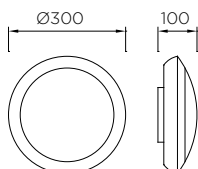
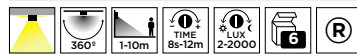

LOFT

15-9810-05-CL 3000K | 1122lm

15-9810-05-CM 4000K | 1224lm

Led 11W | A+... A

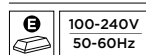
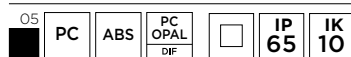



OUTDOOR | CEILING

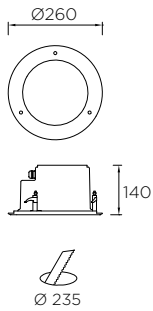

GEA

15-9392-Y4-B8

2 x GX24d-3 26W | A**... B

Y4	INOX AISI 304	GLA MAT DIF	IP 66	IK 08	RF 850°C
M	BAG	230V 50Hz			



2 x GX24d-3 26W

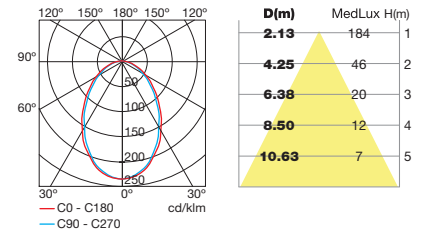

71-9745-05-05



Caja para empotrar en techo de hormigón: página 698
 Built-in concrete ceiling box: page 698
 Boîtier à encastrer dans un plafond en béton : page 698
 Gehäuse zum Einbau in Betondecke: Seite 698
 Scatola per incasso a soffitto in cemento: pagina 698
 Caixa para encastrar em tetos de betão: página 698
 Встраиваемая в цементный потолок коробка 698
 Skrzynka do wbudowania w betonowy sufit: strona 698

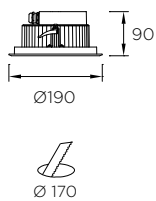

GEA

15-9665-CA-CMV1 4000K | 1647lm

15-9665-CA-CLV1 3000K | 1566lm **NEW**

Led PHILIPS 18W | A**... A

CA	INOX AISI 316	GLA DIF	IP 66	IK 10	RF 850°C
E	EAGLE RISE	100-240V 50-60Hz			



Led 18W

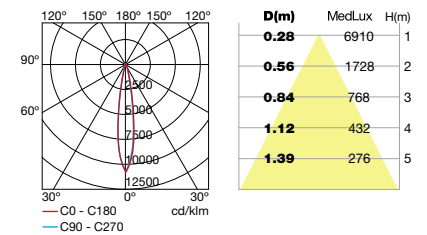

71-9744-05-05



Caja para empotrar en techo de hormigón: página 698
 Built-in concrete ceiling box: page 698
 Boîtier à encastrer dans un plafond en béton : page 698
 Gehäuse zum Einbau in Betondecke: Seite 698
 Scatola per incasso a soffitto in cemento: pagina 698
 Caixa para encastrar em tetos de betão: página 698
 Встраиваемая в цементный потолок коробка 698
 Skrzynka do wbudowania w betonowy sufit: strona 698

RECESSED



OUTDOOR | RECESSED

McDONALD'S SABADELL, SPAIN.



P.703



GEA

15-9708-CA-37

NEW

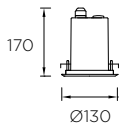

GU-10/GU5.3 max. 50W | L 65mm
Hal - Fluo | A+... C

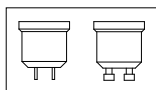
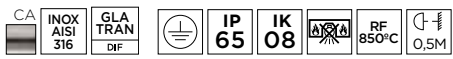

GU5.3 + GU10

GU-10 50W

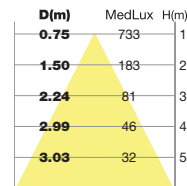
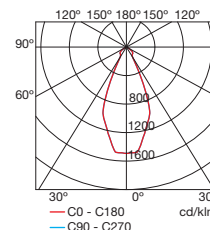

GEA

15-9562-34-37 (S)

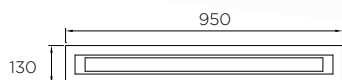

T5 39W Fluo | A+... B



T5 39W

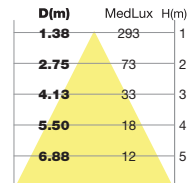
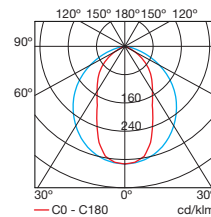

GEA

15-9563-34-37

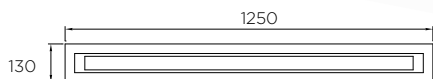

T5 54W Fluo | A+... B



T5 54W

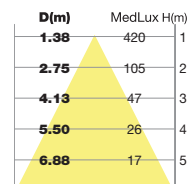
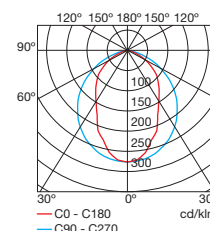



BARCELÓ HOTEL, SANTO DOMINGO.



OUTDOOR | RECESSED

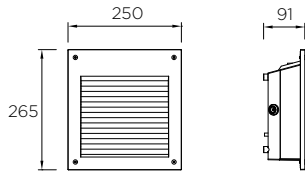

MICENAS LED NEW

05-9885-34-CM
 05-9885-Z5-CM

Led OSRAM 20W | 4000K | 1862lm | A++... A

34	Z5	AL PUR	GLA MAT DIF	IP 65	IK 10	RF 850°C
EAGLE RISE		100-240V 50-60Hz				

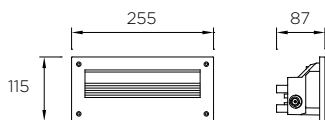
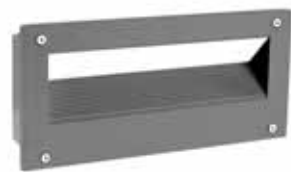

MICENAS

05-9832-34-CM
 05-9832-Z5-CM

Led 5,5W | 4000K | 648lm | A++... A

34	Z5	AL PUR	GLA MAT DIF	IP 65	IK 10	RF 850°C
EAGLE RISE		100-240V 50-60Hz				

Led 5,5W

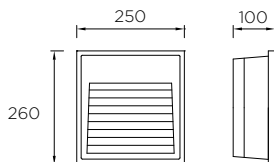
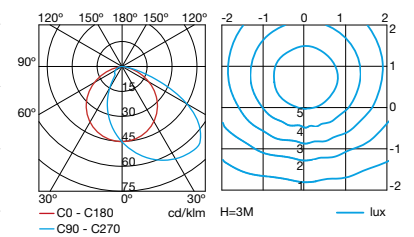

MICENAS

05-9434-34-T2

G24d-3 26W | Fluo | A++... B

34	AL INJ	GLA MAT DIF	IP 54	IK 04	RF 850°C	
BAG		230V 50Hz				

G24 d-3 26W

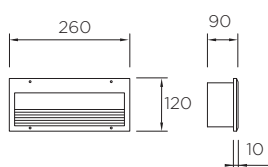
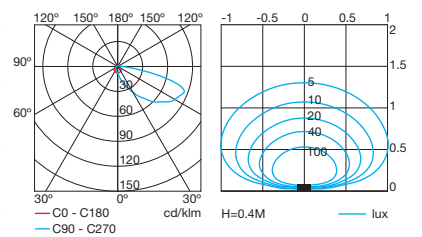

MICENAS

05-9179-14-B8
 05-9179-34-B8
 05-9179-Z5-B8

G24d-3 26W | Fluo | A++... B

14	34	Z5	AL INJ	GLA MAT DIF	IP 44	IK 06	RF 850°C
BAG VOSSLOH		230V 50Hz					

G24d-3 26W

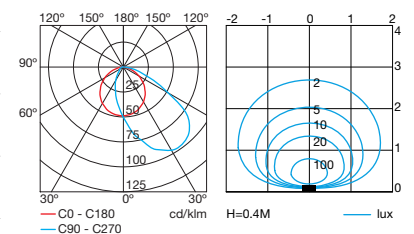

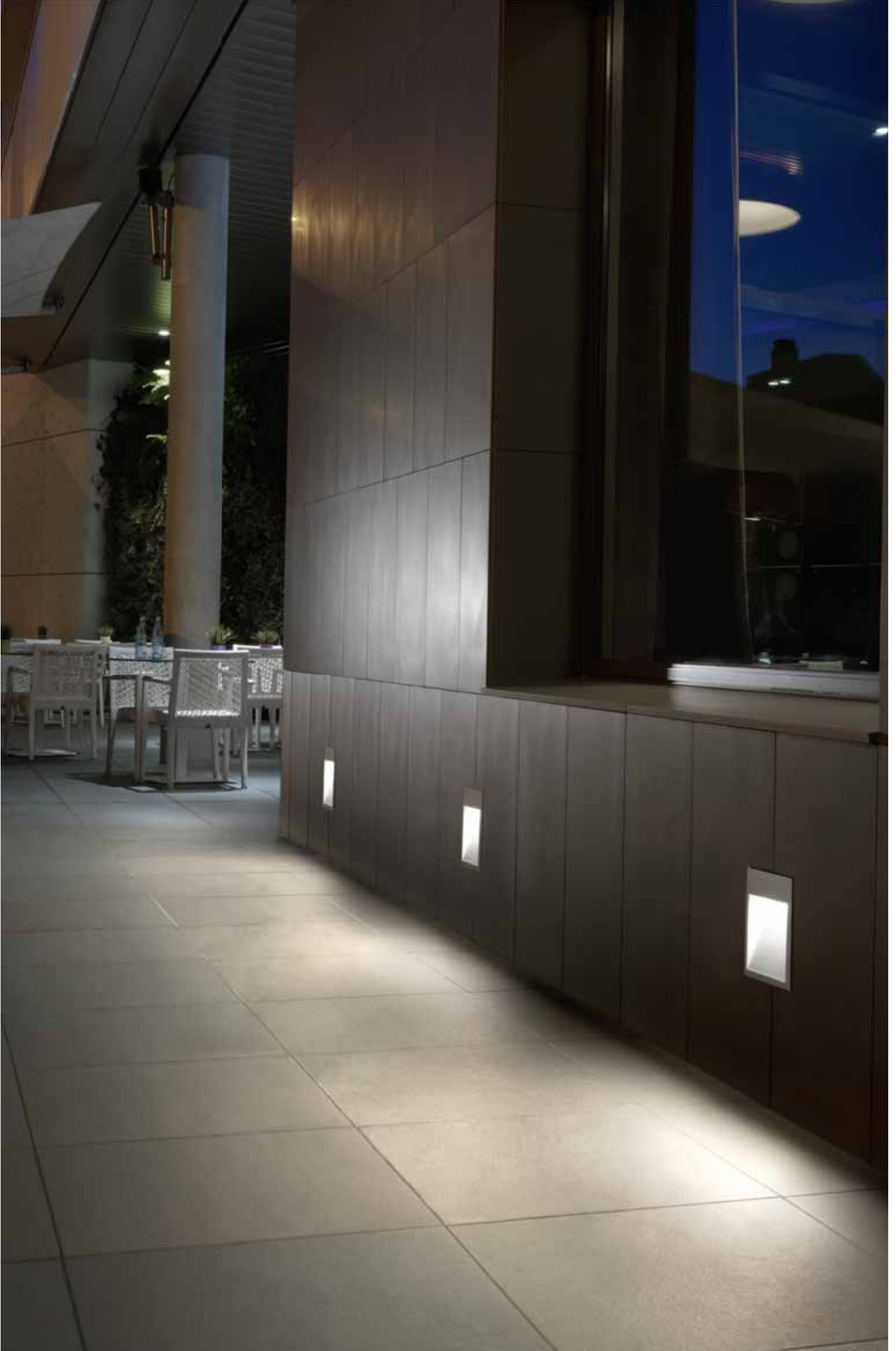

OUTDOOR | RECESSED

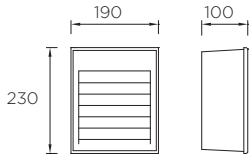

MICENAS

05-9772-34-M2

Led 3W | 4000K | 297lm | A++... A

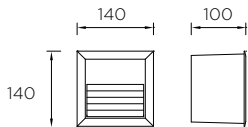
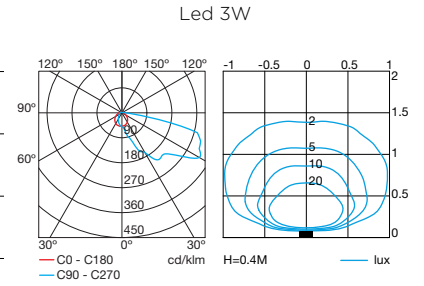
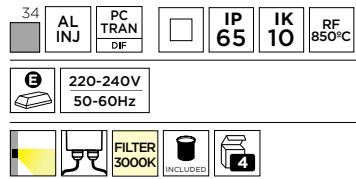

MICENAS

05-9770-34-M2

Led 2W | 4000K | 198lm | A++... A

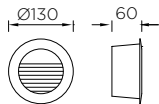
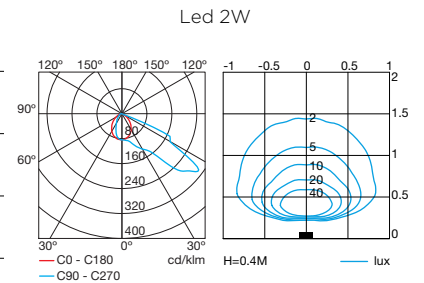
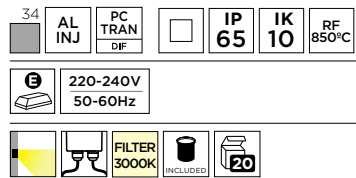

MICENAS

05-9771-34-M2

Led 1,5W | 4000K | 154lm | A++... A

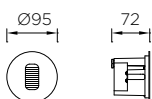
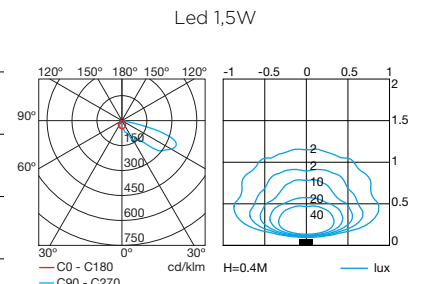
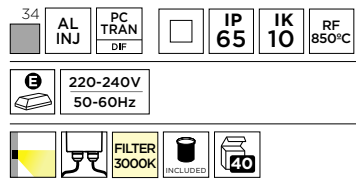

MICENAS

05-9757-CA-CL

Led CREE 2,2W | 3000K | 162lm | A++... A

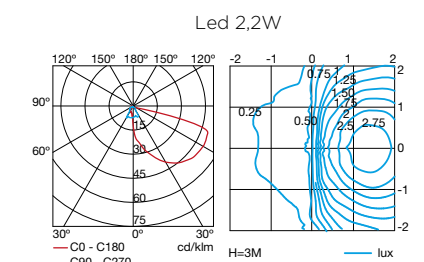
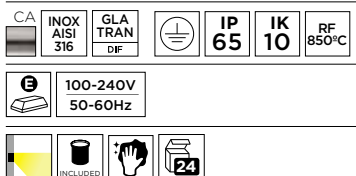

P.703



OUTDOOR | RECESSED



HERCULES

05-9212-CA-T2

E27 max. 60W | max. L 145mm Ø 45mm
Hal - Fluo | **A**... C**

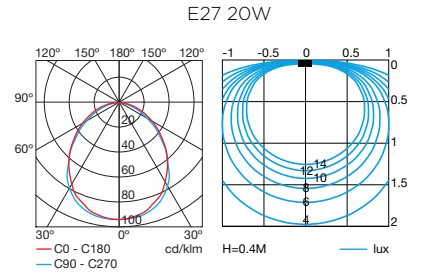
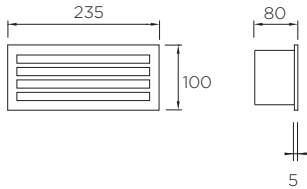

HERCULES

05-9211-CA-T2

E27 max. 60W | max. L 145mm Ø 45mm
Hal - Fluo | **A**... C**

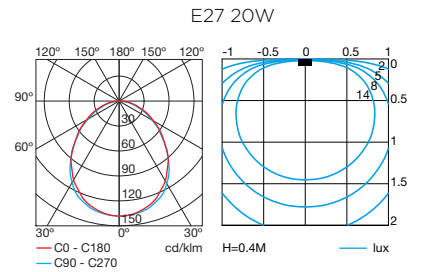
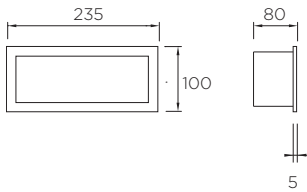

HERCULES

05-8961-05-B8

05-8961-14-B8

05-8961-34-B8

E27 max. 60W | max. L 145mm Ø 45mm
Hal - Fluo | **A**... C**

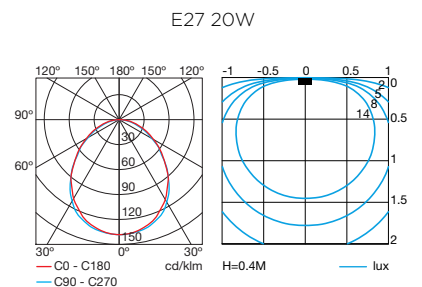
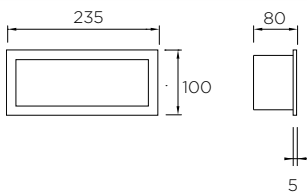
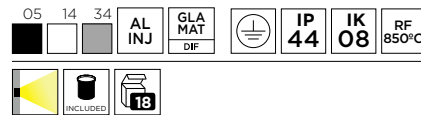

FLUO KIT

71-8969-00-00

G24d-113W | Fluo | **A**... B**



Fluo kit for 05-8961, 05-9211, 05-9212



LED KIT

71-9713-00-00

4000K | 432lm

71-9714-00-00

3000K | 382lm

Led 3,5W | **A**... A**



Led kit for 05-8961, 05-9211, 05-9212



P.703



OUTDOOR | RECESSED

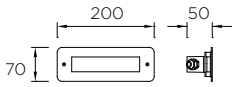

GEA 05-9799-CA-CM

Led 2,2W | 4000K | 291lm | A**... A



Led 2,2W 4000K

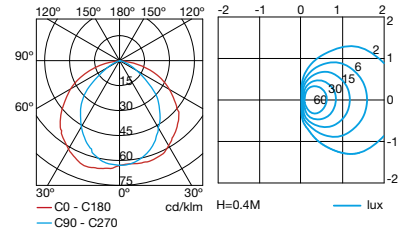

P.703

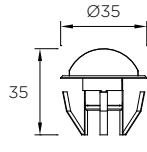

GEA 55-9864-CA-CL

Led 1W | 3000K | 20lm | A**... A

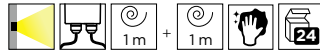
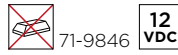
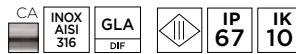

71-9844-05-05
(5u)

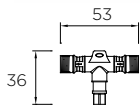

2000



71-9845-05-05
(5u)

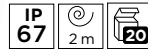

71-9846-05-05
max. 30W

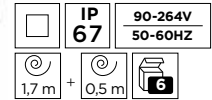

BASIC 05-9833-05-CL 05-9833-05-CM

3000K | 142lm

4000K | 160lm

Led 1,5W | A**... A

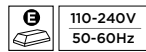
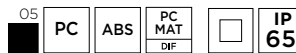

Led 1,5W 4000K

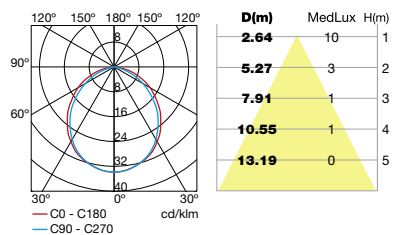

MICENAS 05-9758-34-37

Led CREE 2,2W | 3000K | 162lm | A**... A

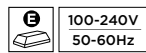

Led 2,2W

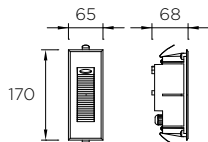
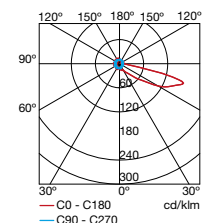

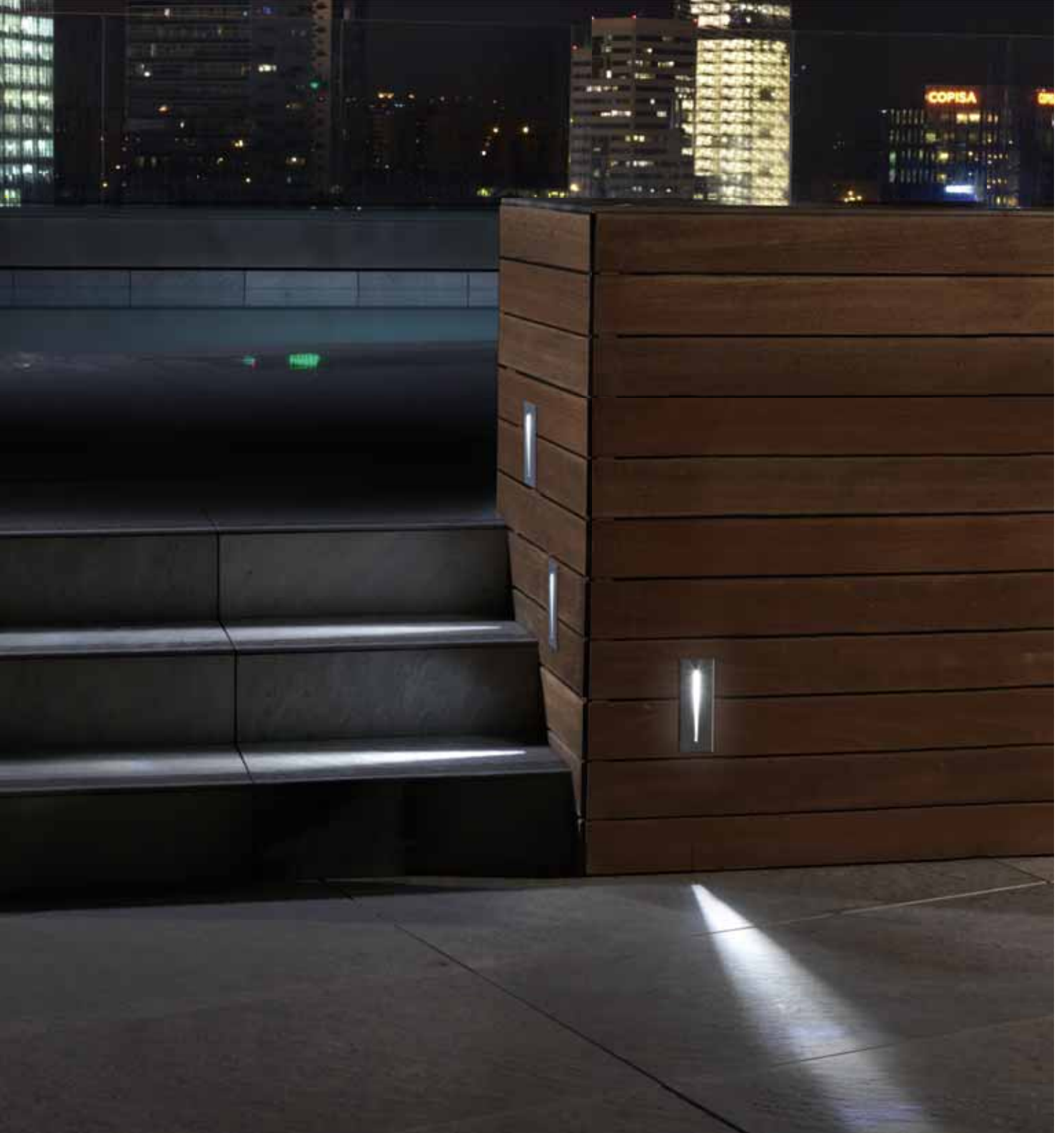

OUTDOOR | RECESSED

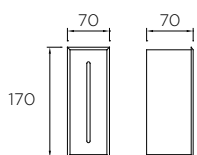

MICENAS

05-9596-34-CL 3000K | 162lm

05-9596-34-37 4000K | 184lm

Led CREE 2,2W | A**... A

34	AL INJ	GLA TRAN DIF		IP 54	RF 850°C
----	-----------	--------------------	--	----------	-------------

	100-240V 50-60Hz
--	---------------------

--	--	--

Led 2,2W 4000K

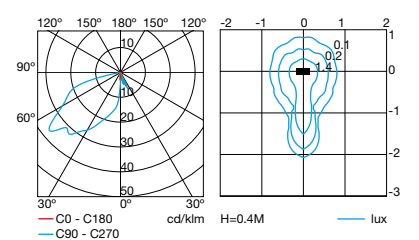

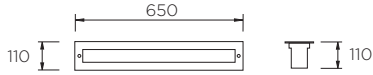

GEA

55-9826-Y4-37

Led CREE 11W | **RGBEASY+** <40°C | A**... A



Led 11W

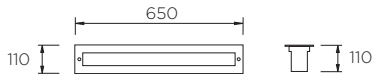
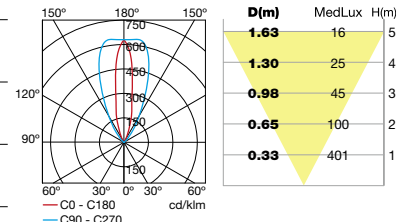

GEA

55-9827-Y4-37

Led CREE 11W | **RGBDMX** <40°C | A**... A

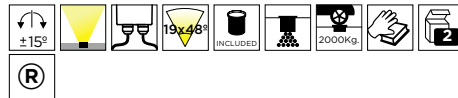

Led 11W

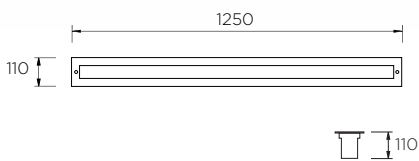
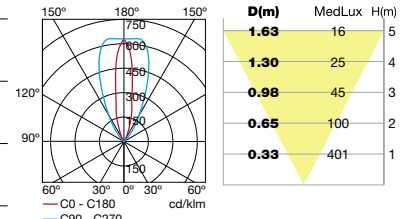

GEA

55-9828-Y4-37

Led CREE 22W | **RGBEASY+** <40°C | A**... A



Led 22W

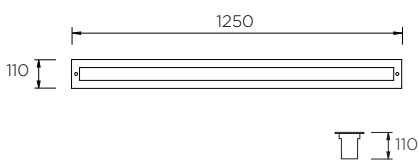
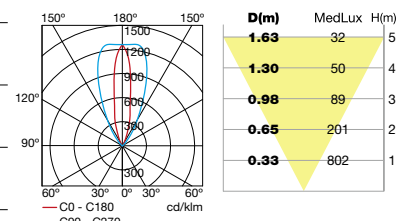

GEA

55-9829-Y4-37

Led CREE 22W | **RGBDMX** <40°C | A**... A



Led 22W

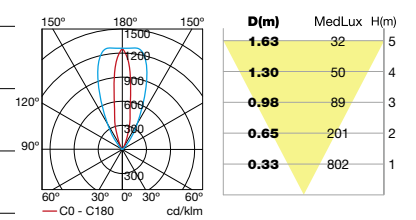

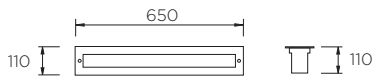

GEA

55-9523-Y4-CL 3000K | 1128lm

55-9523-Y4-CM 4000K | 1284lm

Led CREE 13,5W <40°C | A**... A



Led 4000K 13,5W

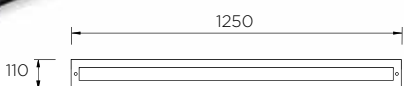
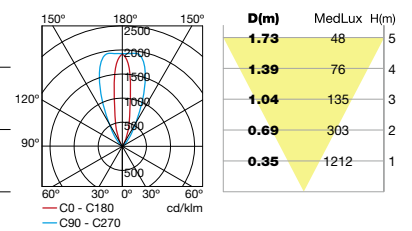

GEA

55-9527-Y4-CL 3000K | 2256lm

55-9527-Y4-CM 4000K | 2568lm

Led CREE 27W <40°C | A**... A



Led 4000K 27W

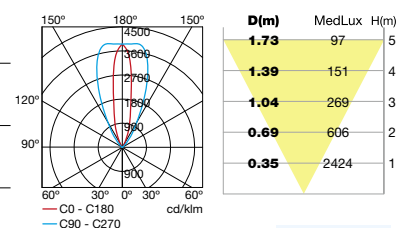

P.703

OUTDOOR | RECESSED



GEA

55-9264-Y4-37

T5 24W Fluor <40°C | A++... B

Y4	INOX AISI 304	GLA HARD DIF	UVA GLA DIF	IP 67	IK 08	RF 850°C	0,2M
BAG	220-240V 50-60Hz						
±15°	INCLUDED	2000Kg	2				

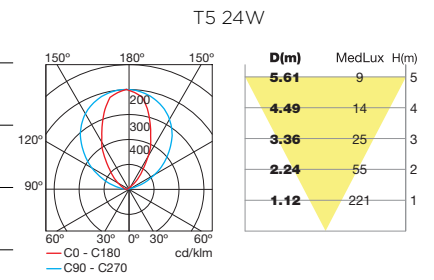

GEA

55-9265-Y4-37 (S)

T5 39W Fluor <40°C | A++... B

Y4	INOX AISI 304	GLA HARD DIF	UVA GLA DIF	IP 67	IK 08	RF 850°C	0,2M
BAG	220-240V 50-60Hz						
±15°	INCLUDED	2000Kg	2				

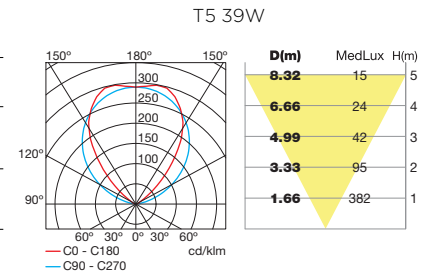

GEA

55-9266-Y4-37

T5 54W Fluor <40°C | A++... B

Y4	INOX AISI 304	GLA HARD DIF	UVA GLA DIF	IP 67	IK 08	RF 850°C	0,2M
BAG	220-240V 50-60Hz						
±15°	INCLUDED	2000Kg	2				

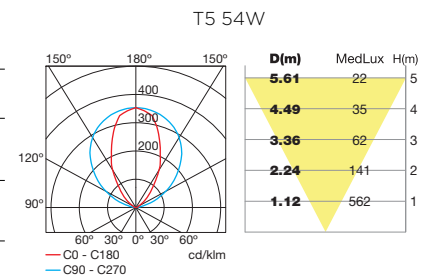



OUTDOOR | RECESSED

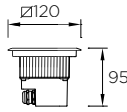

GEA

55-9723-CA-CL 3000K | 522lm **NEW**

55-9723-CA-37 4000K | 549lm

Led PHILIPS 6W <40°C | A+... A



Led 6W 4000K

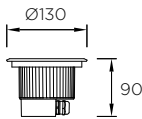
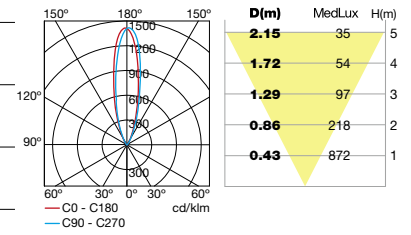

GEA

55-9663-CA-CLV1 3000K | 522lm

55-9663-CA-CMV1 4000K | 549lm

Led PHILIPS 6W | A+... A



Led 6W 4000K

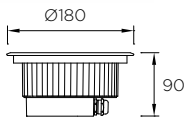
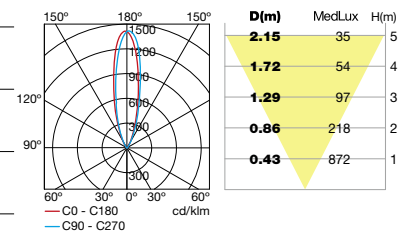

GEA

55-9665-CA-CL 3000K | 873lm

55-9665-CA-37 4000K | 918lm

Led PHILIPS 9W <40°C | A+... A



Led 9W 4000K

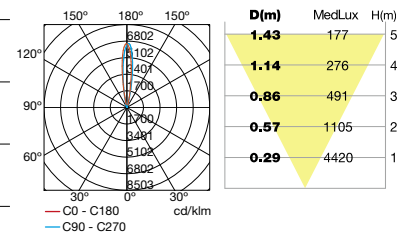



71-9744-05-05
 Caja para empotrar en techo de hormigón: página 698
 Built-in concrete ceiling box: page 698
 Boitier à encastrer dans un plafond en béton: page 698
 Gehäuse zum Einbau in Betondecke: Seite 698
 Scatola per incasso a soffitto in cemento: pagina 698
 Caixa para encastrar em tetos de betão: página 698
 Встраиваемая в цементный потолок коробка 698
 Skrzynka do wbudowania w betonowy sufit: strona 698

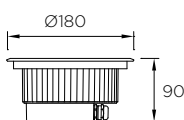

GEA

55-9667-CA-CLV1 3000K | 1566lm

55-9667-CA-CMV1 4000K | 1647lm

Led PHILIPS 18W <40°C | A+... A



Led 18W 4000K

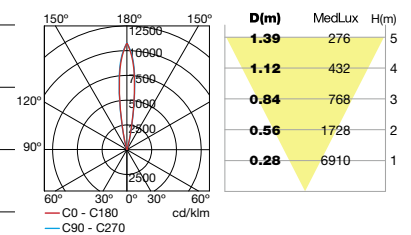



OUTDOOR | RECESSED

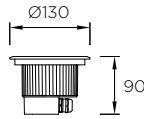

GEA

55-9822-CA-37

Led CREE 6W | **RGBEASY+** | 240lm <40°C | A**... A

CA	INOX AISI 316	GLA HARD DIF	IP 67	IK 10	RF 850°C
----	---------------	--------------	-------	-------	----------

P.694

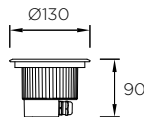

GEA

55-9823-CA-37

Led CREE 6W | **RGBDMX** | 240lm <40°C | A**... A

CA	INOX AISI 316	GLA HARD DIF	IP 67	IK 10	RF 850°C
----	---------------	--------------	-------	-------	----------

P.690 **24 VDC** + DMX CONTROLLER

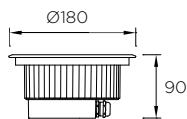

GEA

55-9824-CA-37

Led CREE 11W | **RGBEASY+** | 490lm <40°C | A**... A

CA	INOX AISI 316	GLA HARD DIF	IP 67	IK 10	RF 850°C
----	---------------	--------------	-------	-------	----------

P.694



71-9744-05-05

Caja para empotrar en techo de hormigón: página 698
 Built-in concrete ceiling box: page 698
 Boitier à encastrer dans un plafond en béton: page 698
 Gehäuse zum Einbau in Betondecke: Seite 698
 Scatola per incasso a soffitto in cemento: pagina 698
 Caixa para encastrar em tetos de betão: página 698
 Встраиваемая в цементный потолок коробка 698
 Skrzynka do wbudowania w betonowy sufit: strona 698



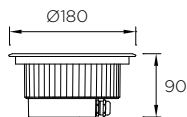

GEA

55-9825-CA-37

Led CREE 11W | **RGBDMX** | 490lm <40°C | A**... A

CA	INOX AISI 316	GLA HARD DIF	IP 67	IK 10	RF 850°C
----	---------------	--------------	-------	-------	----------

P.690 **24 VDC** + DMX CONTROLLER





OUTDOOR | RECESSED

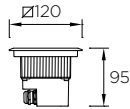

GEA

55-9820-CA-37

Led CREE 6W | **RGBEASY+** | 240lm <40°C | A**... A

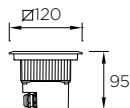

GEA

55-9821-CA-37

Led CREE 6W | **RGBDMX** | 240lm <40°C | A**... A



P.703

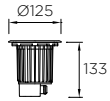

GEA **NEW**

55-9906-CA-CL 3000K | 970lm
 55-9906-CA-CM 4000K | 1040lm

Led CREE 9W <40°C | A**... A

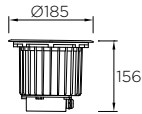
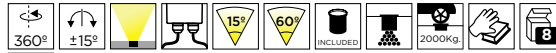

GEA **NEW**

55-9907-CA-CL 3000K | 1890lm
 55-9907-CA-CM 4000K | 2034lm

Led CREE 16W <40°C | A**... A

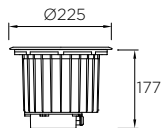
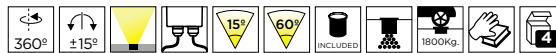

GEA **NEW**

55-9909-CA-CL 3000K | 2784lm
 55-9909-CA-CM 4000K | 2993lm

Led CREE 23W <40°C | A**... A

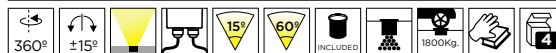

- 2 reflectores + 2 antideslumbrantes incluidos.
- 2 reflectors + 2 anti glare included.
- 2 réflecteurs + 2 antireflets inclus.
- 2 Reflektore + 2 Blend inklusive.
- 2 riflettori + 2 anabbagliante inclusi.
- 2 refletores + 2 anti brilho incluidos.
- Прилагаются 2 отражателя + 2 антибликовый.
- 2 odbłyśniki + 2 akcesoria do uniknięcia odbłasków w komplecie.



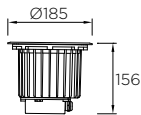

GEA **NEW**

55-9908-CA-CL 3000K | 1785lm

55-9908-CA-CM 4000K | 1983lm

Led LG 17W <40°C | A**... A

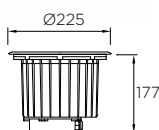
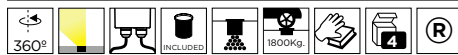

GEA **NEW**

55-9910-CA-CL 3000K | 2696lm

55-9910-CA-CM 4000K | 2995lm

Led OSRAM 24W <40°C | A**... A



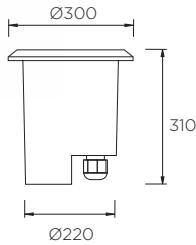

GEA

55-9625-CA-37

G12 150W HID >80°C | A*... A

CA	AL INJ	INOX AISI 316	GLA HARD DIF	IP 67	IK 10	RF 850°C
0,5M						
M	BAG	230V 50Hz				
±15°			15°	100%	INCLUDED	1500Kg

Reflector B Reflector A

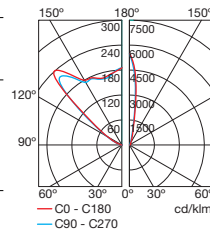

G12 150W

D(m)	MedLux	D(m)	MedLux H(m)
12.11	43	1.32	1811 - 5
9.69	68	1.06	2830 - 4
7.27	120	0.79	5032 - 3
4.85	270	0.53	11321 - 2
2.42	1081	0.26	45284 - 1

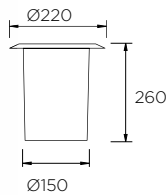

GEA

55-9187-CA-37

55-9187-CA-37 INOX AISI 316

55-9187-Y4-37 INOX AISI 304

G12 70W HID >80°C | A*... A

CA	Y4	AL INJ	INOX AISI 316	INOX AISI 304	GLA HARD DIF	IP 67	IK 10
0,5M							
M	BAG	230V 50Hz					
±15°			18°	100%	INCLUDED	1800Kg	

Reflector B Reflector A

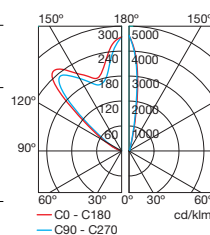

G12 70W

D(m)	MedLux	D(m)	MedLux H(m)
11.22	21	1.06	788 - 5
8.97	33	0.85	1231 - 4
6.73	58	0.64	2189 - 3
4.49	130	0.42	4926 - 2
2.24	522	0.21	19704 - 1

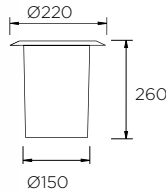

GEA

55-9323-CA-37 **NEW**

G12 35W HID 40-80°C | A*... A

CA	AL INJ	INOX AISI 316	GLA HARD DIF	IP 67	IK 10	0,5M
M	BAG	220-240V 50Hz				
±15°			12°	100%	INCLUDED	1800Kg

Reflector B Reflector A

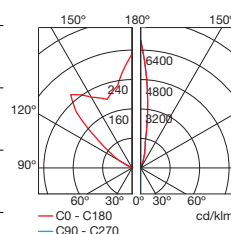

G12 35W

D(m)	MedLux	D(m)	MedLux H(m)
11.26	9	0.97	405 - 5
9.01	15	0.77	633 - 4
6.76	26	0.58	1126 - 3
4.50	59	0.39	2533 - 2
2.25	237	0.19	10130 - 1



2 reflectores incluidos.
2 reflectors included.
2 réflecteurs inclus.
2 Reflektore inklusive.
2 riflettori inclusi.
2 reflectores incluidos
Прилагаются 2
отражателя.
2 odbłyśniki w komplecie



P.703

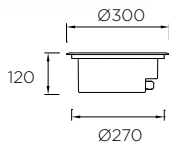

GEA SEASIDE SUITABLE
55-9486-CA-37 NEW

G 8.5 35W HID **40-80°C** | A*... A

CA	AL INJ	INOX AISI 316	GLA HARD DIF		IP 67	IK 10	
----	--------	---------------	--------------	--	-------	-------	--

	BAG	230V 50Hz
--	-----	--------------

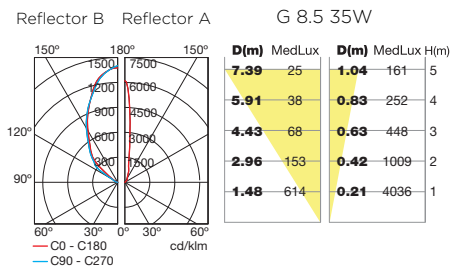

A=16°

B=40°

2 reflectores incluidos.
 2 reflectors included.
 2 réflecteurs inclus.
 2 Reflektore inklusive.
 2 riflettori inclusi.
 2 reflectores incluidos
 Прилагаются 2
 отражателя.
 2 odbłyśniki w komplecie

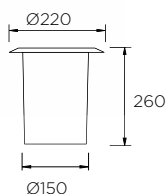

GEA
55-9433-Y4-37

Rx7s 70W HID **>80°C** | A*... A

Y4	AL INJ	INOX AISI 304	GLA HARD DIF		IP 67	IK 10	
----	--------	---------------	--------------	--	-------	-------	--

	BAG	230V 50Hz
--	-----	--------------

--	--	--	--	--	--

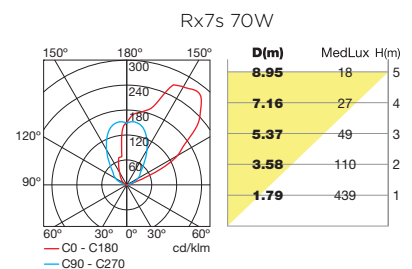

OUTDOOR | RECESSED

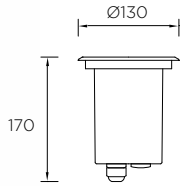

GEA

55-9567-Z5-37

GU-10 max. 50W | max. L 80mm
Hal >80°C - Fluo 40-80°C | A**... C

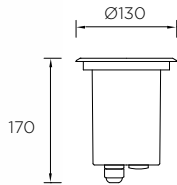
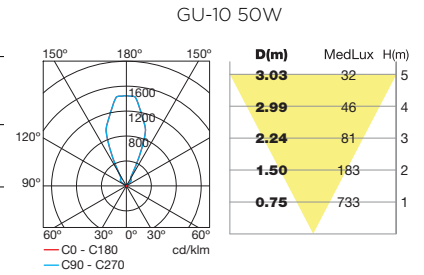
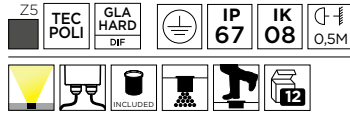

55-9280-CA-37

GEA

55-9280-CA-37

INOX AISI 316

55-9280-Y4-37

INOX AISI 304

GU-10 max. 50W | max. L 82 mm
Hal >80°C - Fluo 40-80°C | A**... C

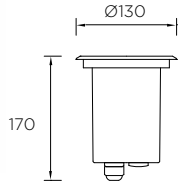
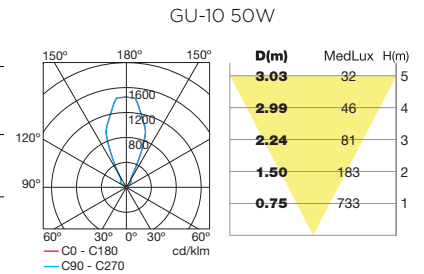

GEA

55-9380-CA-37

GU-10 max. 50W | max. L 55mm
Hal >80°C - Fluo 40-80°C | A**... C

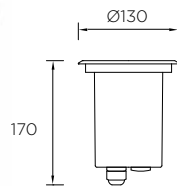
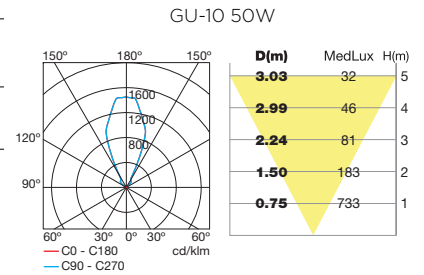
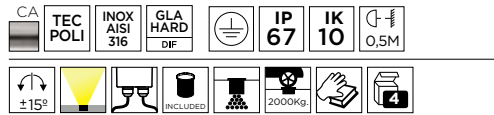

GEA

55-9635-CA-37

GU5.3 max. 50W
Hal >80°C | A**... C

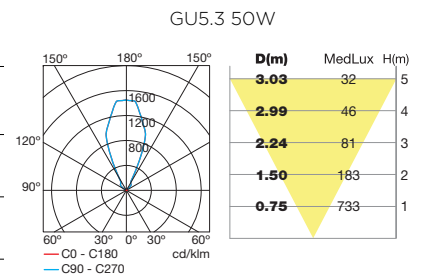
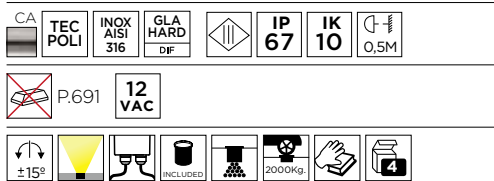

P.703



OUTDOOR | RECESSED

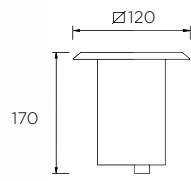

GEA

55-9737-CA-37

GU-10 max. 50W | max. L 55mm
Hal >80°C - Fluo 40-80°C | A**... C

CA	TEC POLI	INOX AISI 316	GLA HARD DIF	IP 67	IK 10	0,5M
±15°	Light bulb icon	Glasses icon	Can icon	2000Kg icon	Hand icon	Box icon

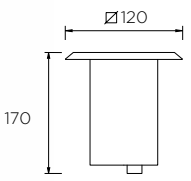
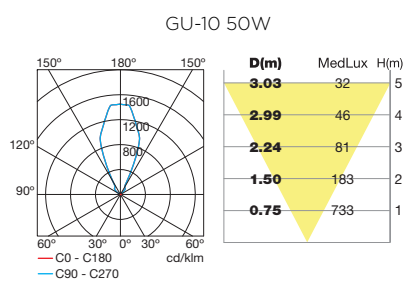

GEA

55-9281-CA-37 **NEW**

GU-10 max. 50W | max. L 65mm (Led max.5W)
Hal >80°C - Fluo 40-80°C | A**... C

CA	TEC POLI	INOX AISI 316	GLA HARD DIF	IP 67	IK 10	0,5M
Light bulb icon	Glasses icon	Can icon	2000Kg icon	Hand icon	Box icon	8

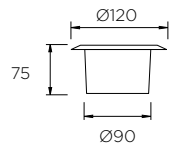
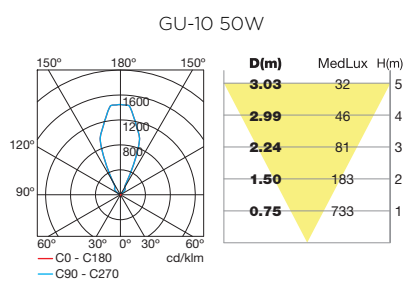

GEA

55-9184-Y4-37

GX 53 max. 9W Fluo 40-80°C | A**... C

Y4	AL INJ	INOX AISI 304	GLA HARD DIF	IP 67	IK 10
Light bulb icon	Glasses icon	Can icon	2000Kg icon	Hand icon	Box icon

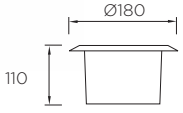
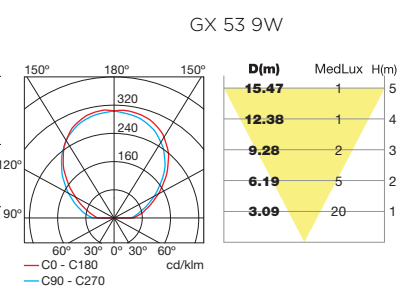

GEA

55-9337-CA-37 **NEW**

G-53 max. 75W Hal >80°C | A**... C

CA	INOX AISI 316	GLA HARD DIF	TEC POLI	IP 67	IK 10	0,5M
Light bulb icon	Glasses icon	Can icon	1800Kg icon	Hand icon	Box icon	8

12 VAC

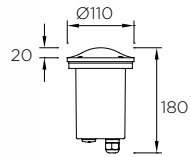
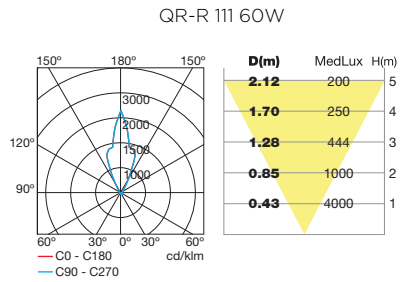

XENA

55-9421-M3-M3

GU-10 max. 11W | max. L 80mm
Fluo <40°C | A**... C

M3	TEC POLI	PC TRAN DIF	IP 67	IK 10
Light bulb icon	Glasses icon	Can icon	1800Kg icon	Hand icon

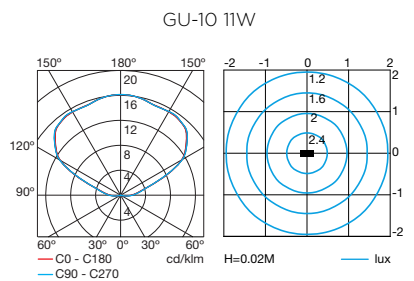

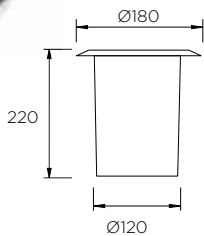

55-9186-CA-37

GEA

55-9186-CA-37

INOX AISI 316

55-9186-Y4-37

INOX AISI 304

Par-30 E27 max. 75W | max. L 160mm

Hal 40-80°C - Fluo 40-80°C | A**... C



IP 67 IK 10 0,5M



2 cristales incluidos.
2 glasses included.
2 verres compris.
2 Gläser inklusive.
2 vetri inclusi.
2 vidros incluídos.
Прилагаются 2 стекла.
2 szybki w komplecie.

PAR-30 75W

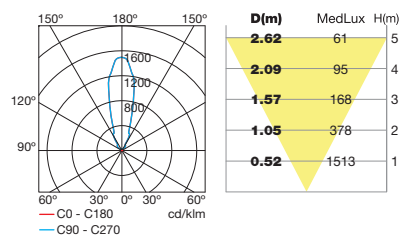

GEA

55-9255-54-37

■

GU4 max. 20W Hal >80°C | A**... C

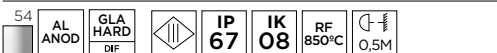

IP 67 IK 08 RF 850°C 0,5M



12 VAC



GU4 20W

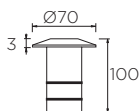
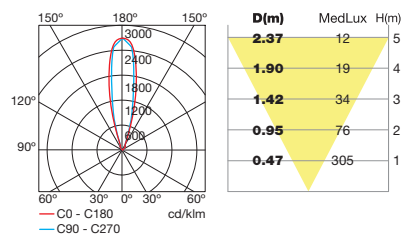

OUTDOOR | RECESSED

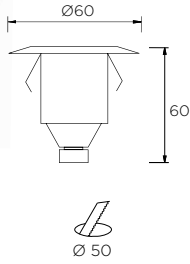

GEA

55-9769-54-T2

Led 1W | 4000K | 96lm <40°C | A**... A

54 AL ANOD PC MAT DIF IP 67 IK 05

12 VAC P.691 12 VDC P.690

FILTER 3000K INCL. 2,5 m 20

Led 1W

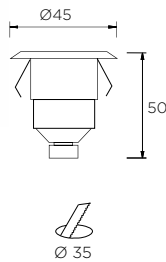
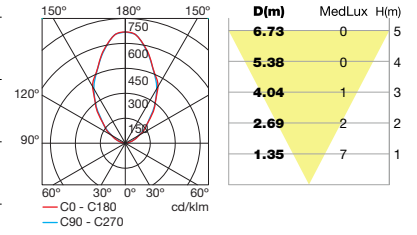

GEA

55-9768-54-T2

Led 0,5W | 4000K | 48lm <40°C | A**... A

54 AL ANOD PC MAT DIF IP 67 IK 05

12 VAC P.691 12 VDC P.690

FILTER 3000K INCL. 2,5 m 33

Led 0,5W

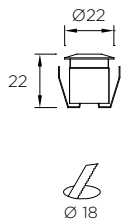
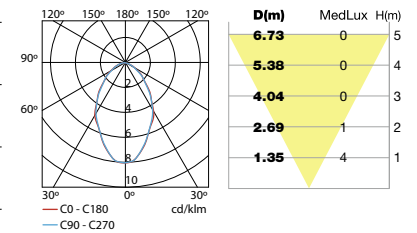

GEA



55-9794-CA-CL

Led 0,6W | 3000K | 12lm | A**... A

CA INOX AISI 316 GLA TRAN DIF IP 67 IK 10

71-9846 12 VDC

0,5 m + 0,5 m 24

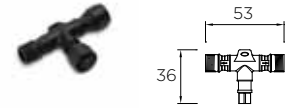

71-9844-05-05

(5u)

IP 67 20



71-9845-05-05

(5u)

IP 67 2 m 20



71-9846-05-05

max. 30W

IP 67 90-264V 50-60HZ 1,7 m + 0,5 m 6

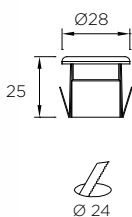

GEA



55-9795-CA-CL

Led 1W | 3000K | 20lm | A**... A

CA INOX AISI 316 GLA MAT DIF IP 67

71-9846 12 VDC

1 m + 1 m 2



P.703



ALCOLEA PSYCHIATRIC CENTER. CÓRDOBA, SPAIN.



GEA

55-9282-CA-CMV1

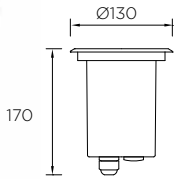

Led 1W | 4000K | 144lm <40°C | A**... A

CA	TEC POLI	INOX AISI 316	GLA HARD DIF		IP 67	IK 10
----	----------	---------------	--------------	--	-------	-------

E	100-240V
	50-60Hz

2000Kg	Hand icon	FILTER 3000K	Color swatches	INCLUDED	Wrench icon	12
--------	-----------	--------------	----------------	----------	-------------	----

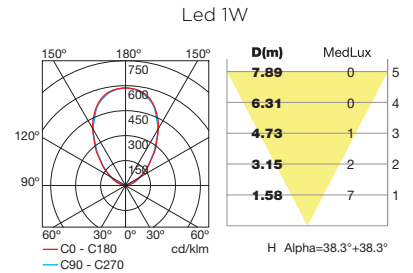

GEA

55-9620-54-CL 3000K | 94lm

55-9620-54-T2 4000K | 107lm

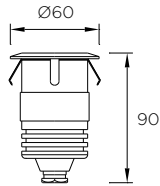

Led CREE 1W <40°C | A**... A

54	AL ANOD	GLA HARD DIF		IP 67	IK 10
----	---------	--------------	--	-------	-------

E	EAGLE RISE	100-240V
		50-60Hz

Color swatches	INCLUDED	Wrench icon	2.5 m	12
----------------	----------	-------------	-------	----

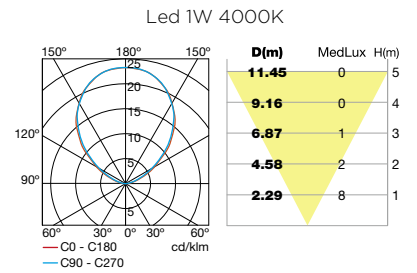

GEA

55-9621-54-CL 3000K

55-9621-54-T2 4000K

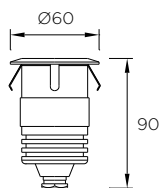

Led CREE 1W | 350mA | 107lm | 2W | 700mA | 184lm <40°C | A**... A

54	AL ANOD	GLA HARD DIF		IP 67	IK 10
----	---------	--------------	--	-------	-------

B	P.682	max. 700 mA
---	-------	-------------

Color swatches	INCLUDED	Wrench icon	12
----------------	----------	-------------	----

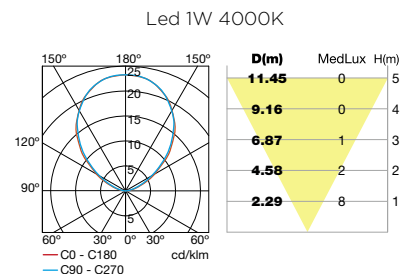

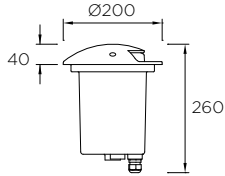

XENA

55-9426-34-M3 ■

E27 max. 20W | max. L 175mm

Fluo 40-80°C | A**... C

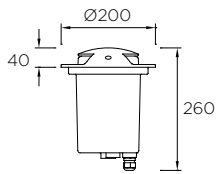
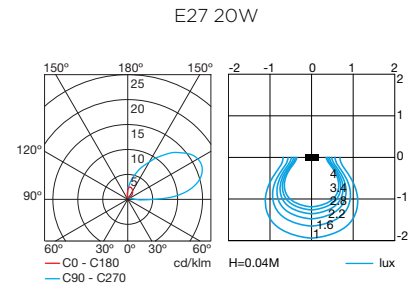
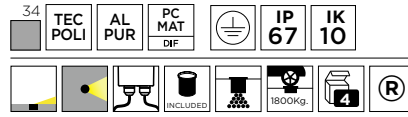

XENA

55-9427-34-T2 ■

E27 max. 20W | max. L 175mm

Fluo 40-80°C | A**... C

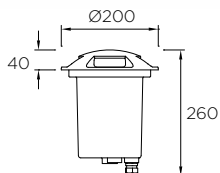
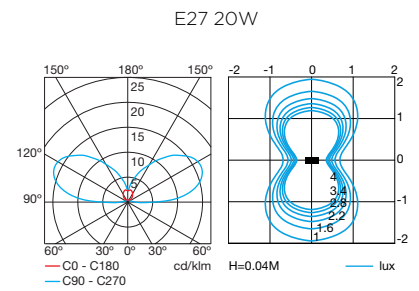
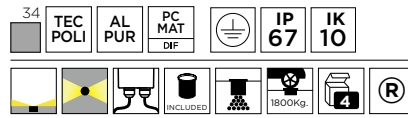

XENA

55-9428-34-T2 ■

E27 max. 20W | max. L 175mm

Fluo 40-80°C | A**... C

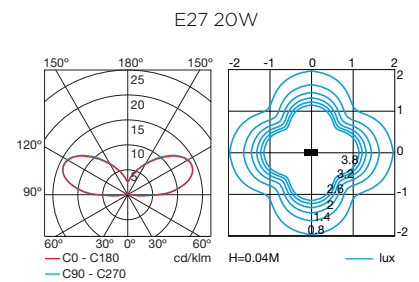
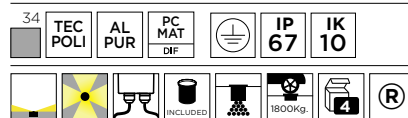

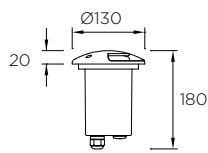

XENA

55-9422-34-M3V1 ■

Led 0,5W | 4000K | 64lm <40°C | A**... A

34	TEC POLI	AL PUR	PC MAT DIF	IP 67	IK 10
E	100-240V 50-60Hz				
	FILTER 3000K	INCLUDED	1800Kg	4	R

Led 0,5W

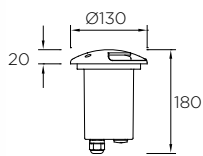
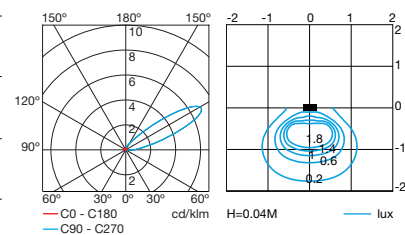

XENA

55-9423-34-M3V1 ■

Led 1W | 4000K | 128lm <40°C | A**... A

34	TEC POLI	AL PUR	PC MAT DIF	IP 67	IK 10
E	100-240V 50-60Hz				
	FILTER 3000K	INCLUDED	1800Kg	4	R

Led 1W

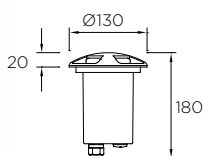
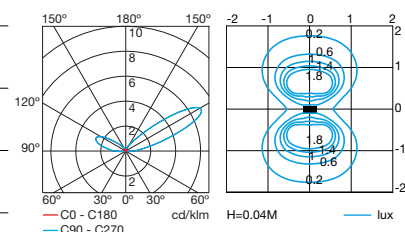

XENA

55-9424-34-M3V1 ■

Led 1W | 4000K | 128lm <40°C | A**... A

34	TEC POLI	AL PUR	PC MAT DIF	IP 67	IK 10
E	100-240V 50-60Hz				
	FILTER 3000K	INCLUDED	1800Kg	4	R

Led 1W

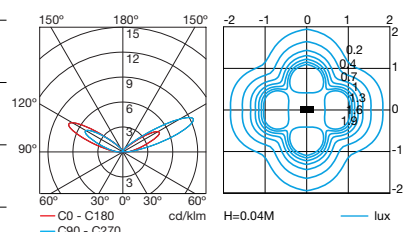

OUTDOOR | RECESSED

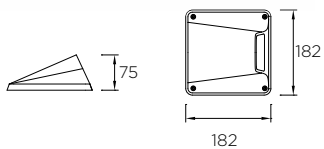

REXEL

55-9741-Z5-37

Led CREE 4,3W | 3000K | 304lm | A**... A

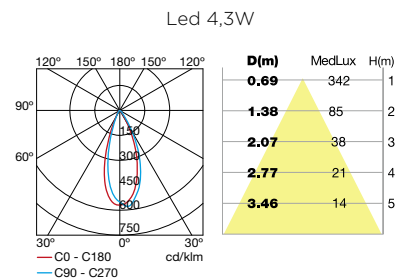
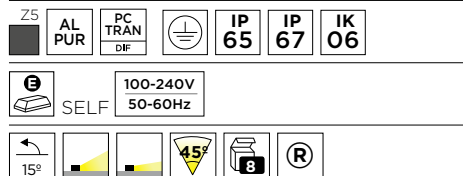

REXEL NEW

55-9883-Z5-CL

Led CREE 2,1W | 3000K | 228lm | A**... A

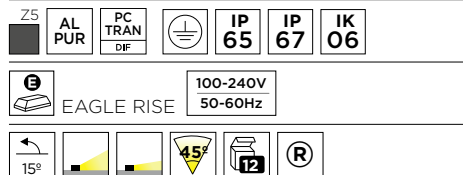

ODIN



10-9645-Z5-M2

E27 max. 60W | max. L 180mm
Hal - Fluo | A**... C

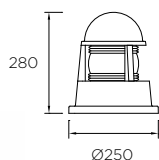
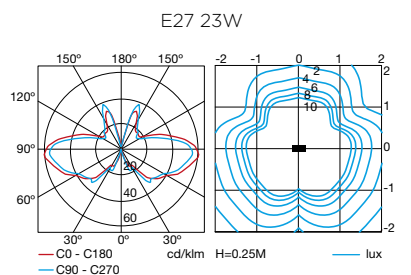
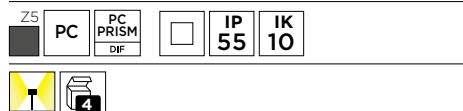

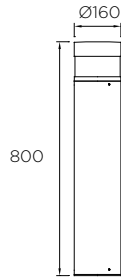

NEWTON

55-9791-Z5-CL ■

Led CREE 13W | 3000K | 1248lm | A**... A

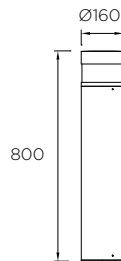
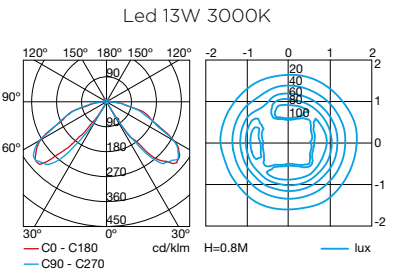

NEWTON

55-9504-Z5-M2 ■

E27 max. 23W | max. L 155mm Ø 55mm
Fluo | A**... C

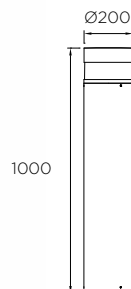
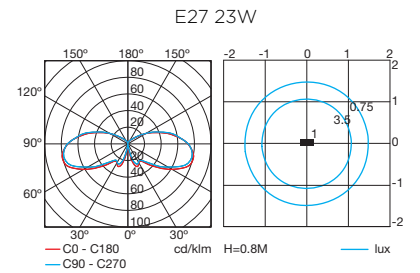

NEWTON

55-9550-Z5-M2 ■

E27 max. 23W | max. L 165mm Ø 55mm
Fluo | A**... C

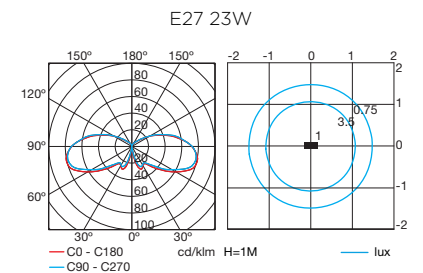

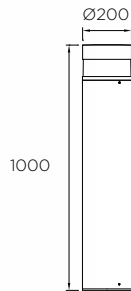

NEWTON

55-9551-Z5-M2

■ IP 65 35W

55-9552-Z5-M2

■ IP 54 70W

G12 HID | A*... A

Z5 AL EXTR PC TRAN DIF IK 08

M 230V 50Hz

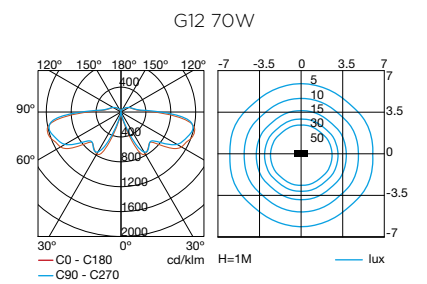

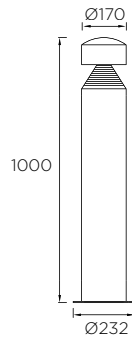

CILIN NEW

55-9890-Z5-CL ■

Led CREE 23W | 3000K | 2120lm | **A++... A**

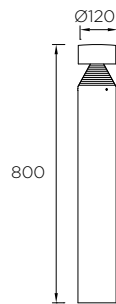

CILIN

55-9706-Z5-CLV1 ■

Led CREE 13,5W | 3000K | 1140lm | **A++... A**

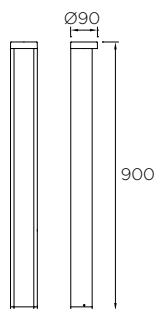
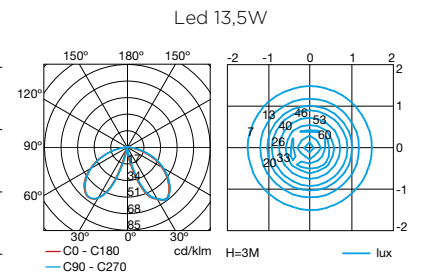

HAUTE

55-9834-34-CL ■

Led 7W | 3000K | 567lm | **A++... A**

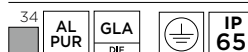



OUTDOOR | BOLLARDS

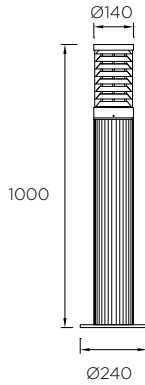

TEMIS

55-9479-34-M2

E27 max. 100W | max. L 160mm Ø 55mm
Hal - Fluo | A**... C



E27 30W

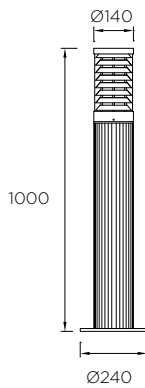
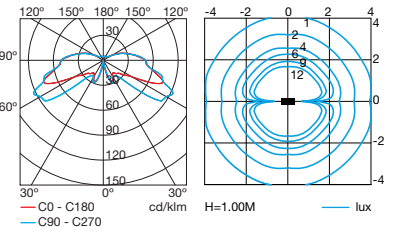

TEMIS

55-9530-34-M2

G12 70W HID | A**... A



G12 70W

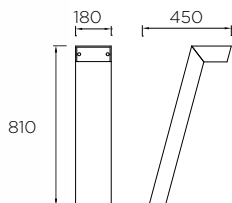
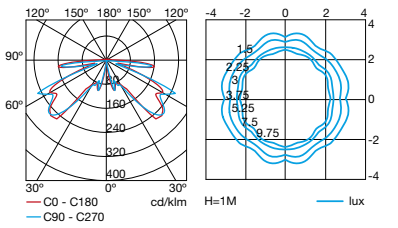

TORCH

55-9459-Z5-M3

2 x E27 max. 18W | max. L 150mm Ø 50mm
Fluo | A**... C



2 x E27 18W

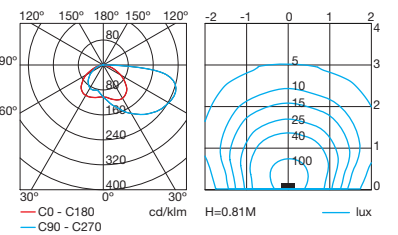



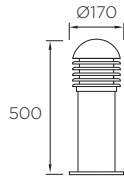

BALIZAS

55-9319-Z5-M3 ■

E27 max. 100W | max. L 140mm Ø 55mm
Hal - Fluo | A**... C

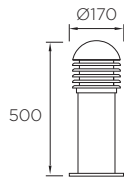
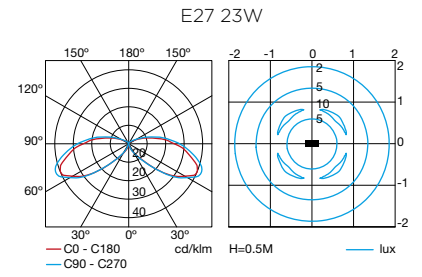
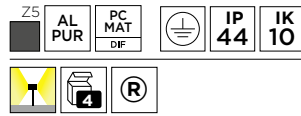

BALIZAS

55-9342-Z5-M3 ■

G12 70W HID | A*... A

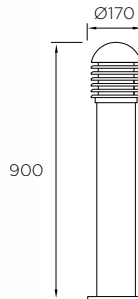
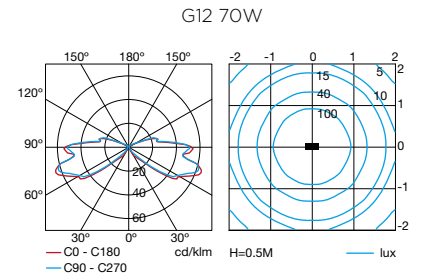
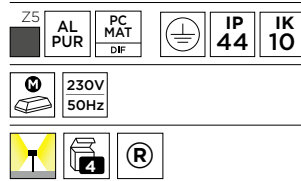

BALIZAS

55-9320-Z5-M3 ■

E27 max. 100W | max. L 140mm Ø 55mm
Hal - Fluo | A**... C

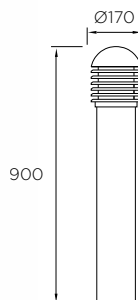
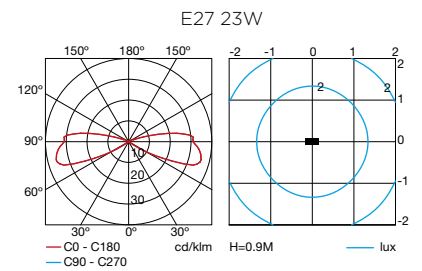
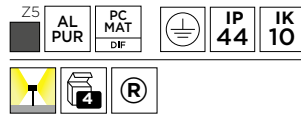

BALIZAS

55-9343-Z5-M3 ■

G12 70W HID | A*... A

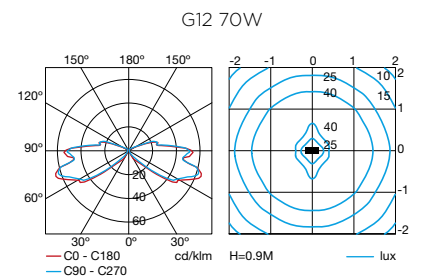
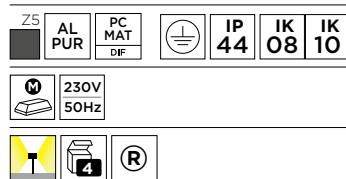

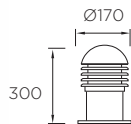

BALIZAS

55-9318-Z5-M3 ■

E27 max. 100W | max. L 170mm
Hal - Fluo | A**... C

Z5	AL PUR	PC MAT DIF	⊕	IP 44	IK 10
⚡	6	®			

E27 23W

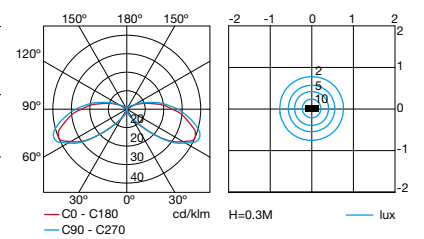

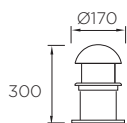

BALIZAS

55-9334-Z5-M3 ■

E27 max. 100W | max. L 170mm
Hal - Fluo | A++... C



E27 23W

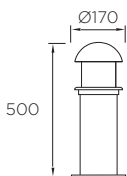
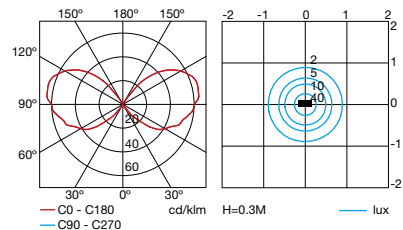

BALIZAS

55-9335-Z5-M3 ■

E27 max. 100W | max. L 140mm Ø 55mm
Hal - Fluo | A++... C



E27 23W

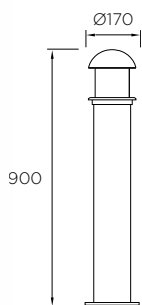
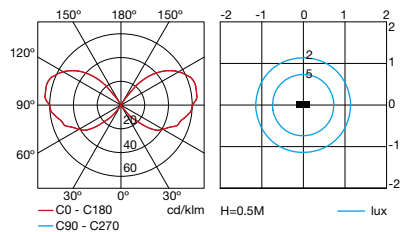

BALIZAS

55-9336-Z5-M3 ■

E27 max. 100W | max. L 140mm Ø 55mm
Hal - Fluo | A++... C



E27 23W

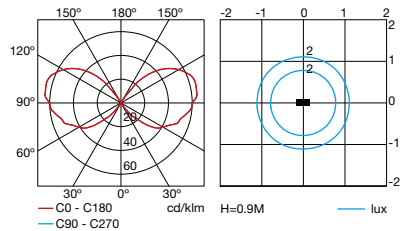

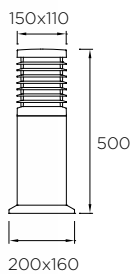

NOTT

55-9358-34-M3 ■

55-9358-Z5-M3 ■

E27 max. 30W | max. L 190mm
Hal - Fluo | A++... C

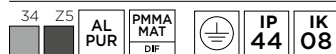

E27 23W

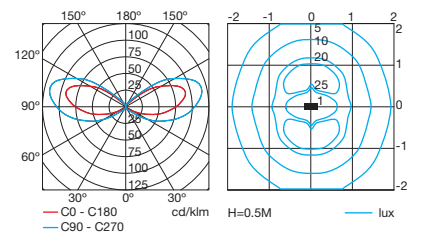

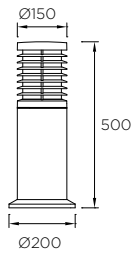

NOTT

55-9655-05-CD ■

E27 max. 23W | max. L 190mm
Fluo | **A++... C**

05	PP	PC MAT DIF	□	IP 65	IK 08

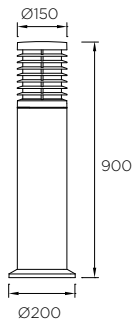

NOTT

55-9656-05-CD ■

E27 max. 23W | max. L 190mm
Fluo | **A++... C**

05	PP	PC MAT DIF	□	IP 65	IK 08

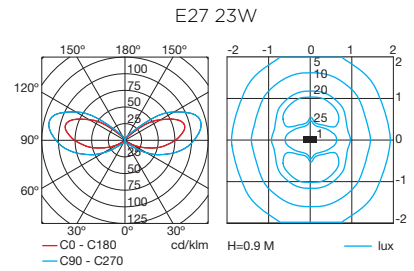

SMILE

55-9848-05-M1 ■

E27 max. 18W | max. L 140mm Ø 49mm
Fluo | **A++... C**

05	PP	PC OPAL DIF	□	IP 54	IK 08

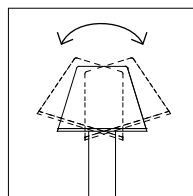



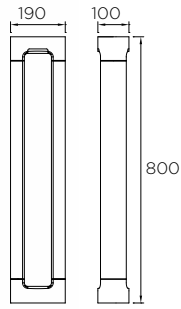

MÜLLER

55-9557-Z5-CL

Led BRIDGELUX 8,7W | 3000K | 975lm | A**... A

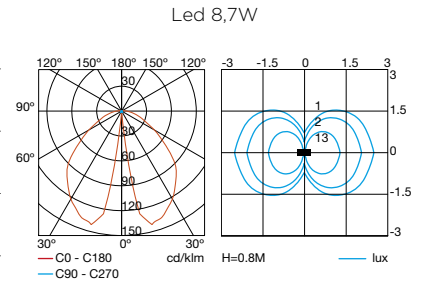
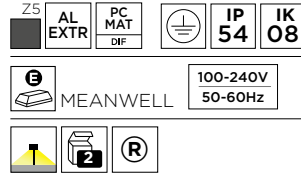

HELION

55-9721-Z5-M1

Led BRIDGELUX 6,7W | 3000K | 640lm | A**... A

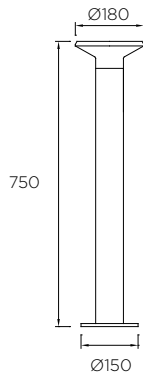
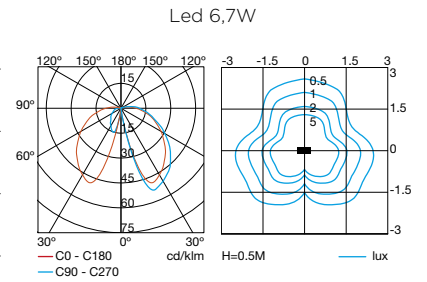
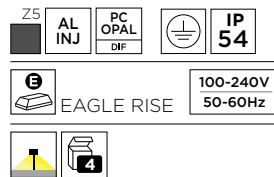

SPACE

55-9872-Z5-CL

Led SHARP 7,5W | 3000K | 650lm | A**... A

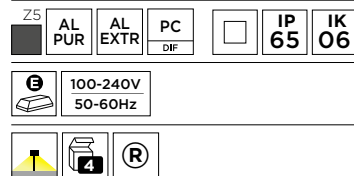

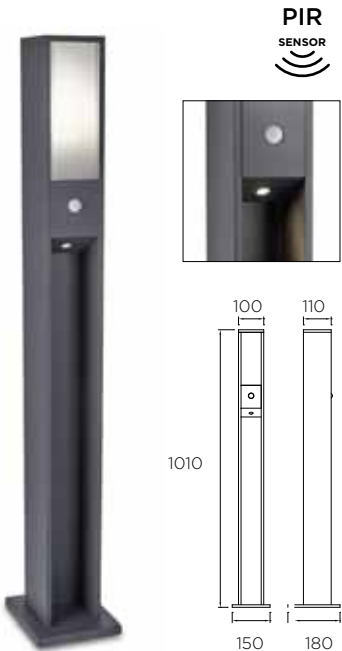
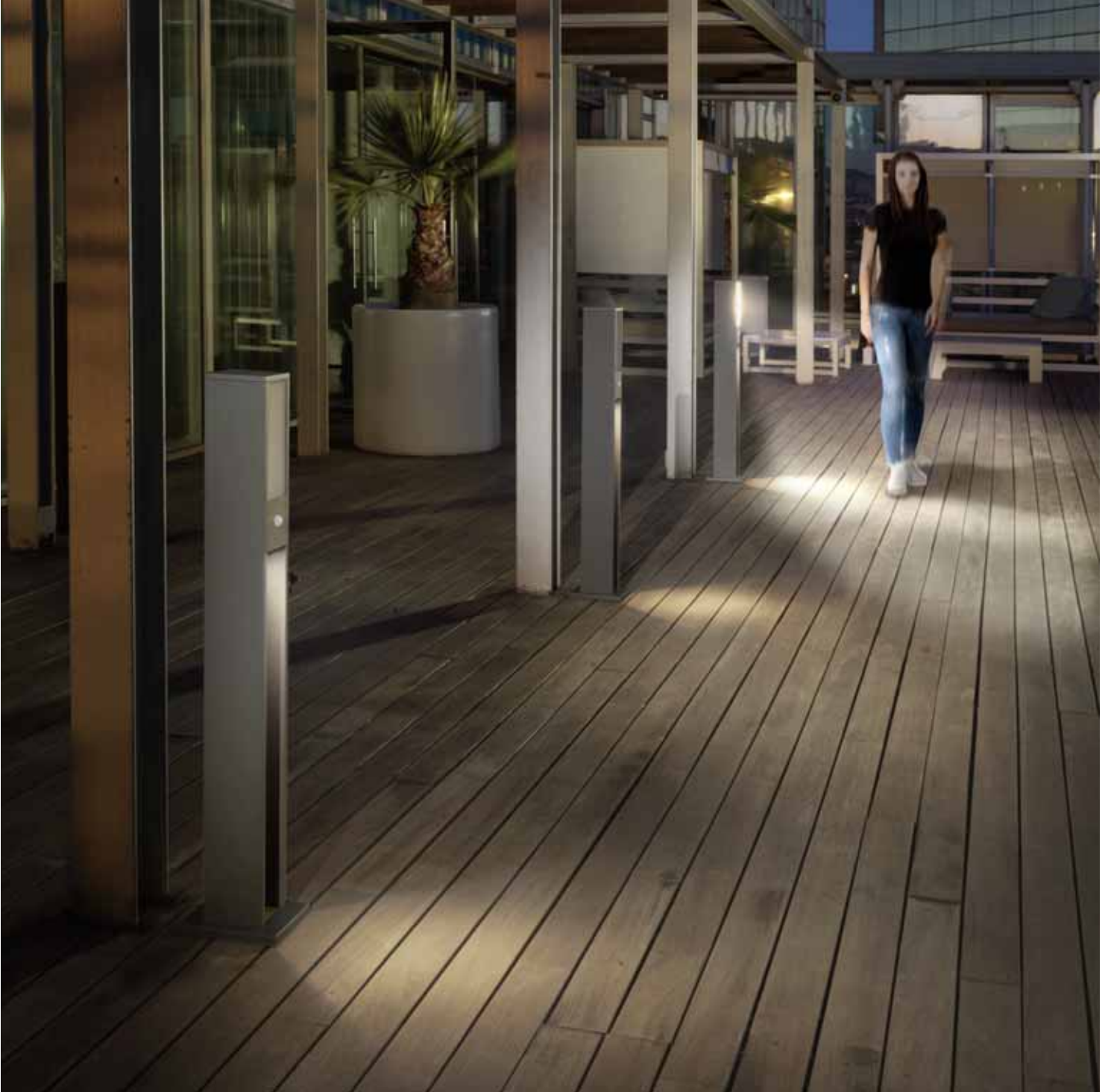

PIR
SENSOR

TWO-LIGHT

55-9775-Z5-CD

E27 max.23W Fluo | L 180mm | A**... C

+
Led 1W | 3000K | 94lm | A**... A



EAGLE RISE 220-240V 50-60Hz

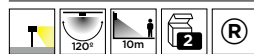

Led



Led+E27

E27 23W + Led 1W

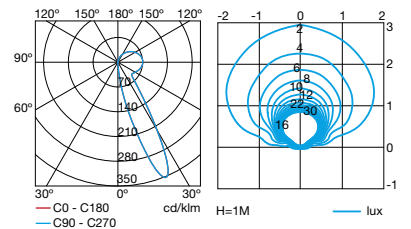

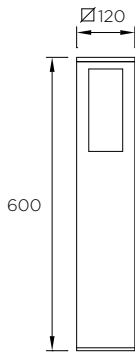

WAY

55-9682-Z5-37

GU-10 max. 50W | max. L 80mm
Hal - Fluo | A**... C

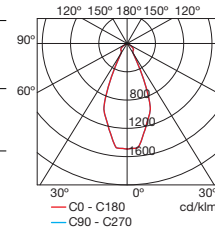
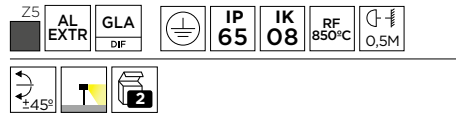

GU-10 50W

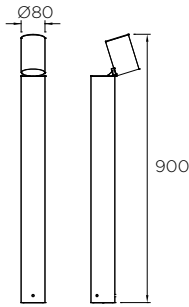
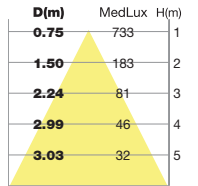

COSMOS

55-9867-J6-CL

Led 7W | 3000K | 585lm | A**... A

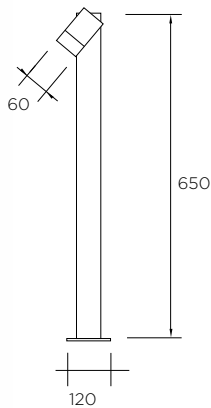
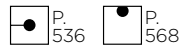
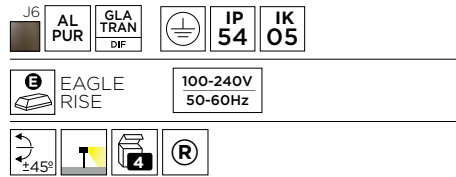

ICARO

55-9190-34-37

2 x GU-10 max. 50W | max. L 75mm
Hal - Fluo | A**... C

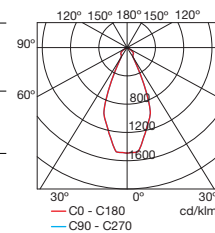
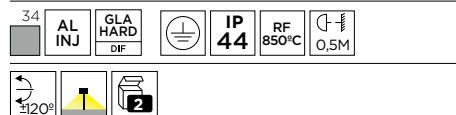

GU-10 50W

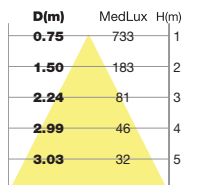

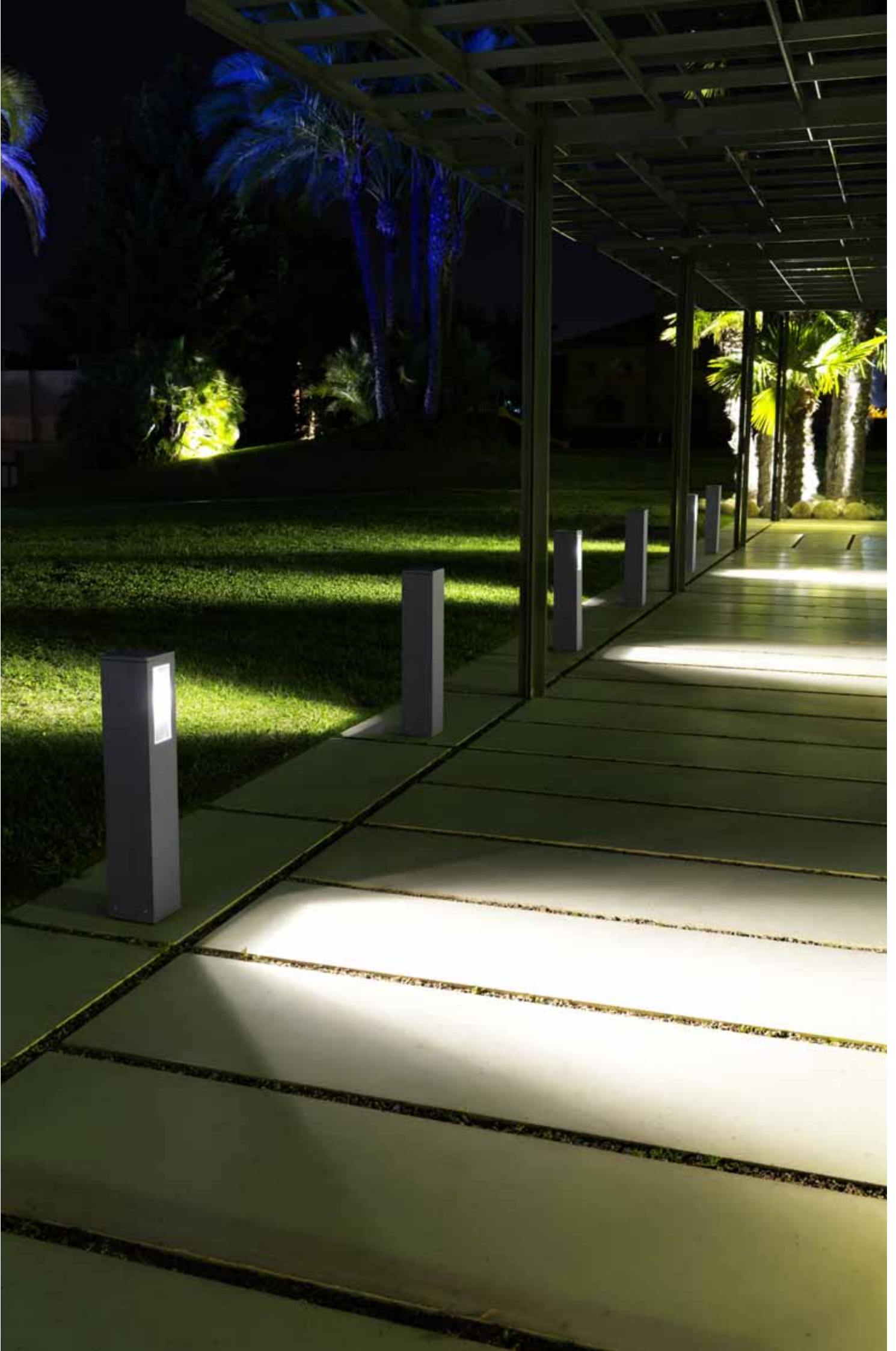

OUTDOOR | BOLLARDS

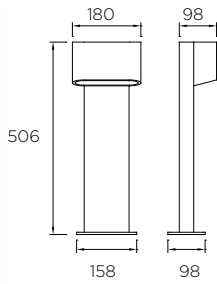

DIAGO

55-9873-Z5-CL ■

Led SHARP 5W | 3000K | 335lm | A**... A

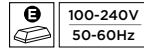

Led 5W 3000K

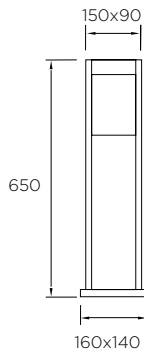
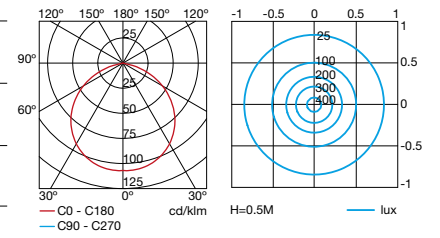

HEBE

55-9238-34-M3 ■

E27 max. 100W | max. L 167mm Ø 51mm
Fluo | A**... C

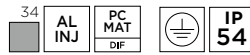

E27 30W

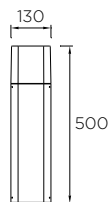
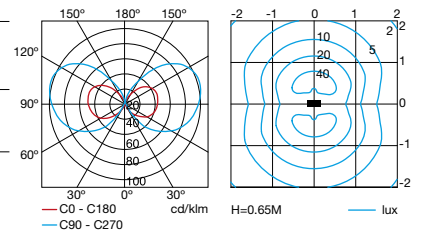

MANDELA

55-9605-Z5-M1 ■

E27 max. 23W | max. L 150mm
Fluo | A**... C

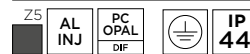

E27 18W

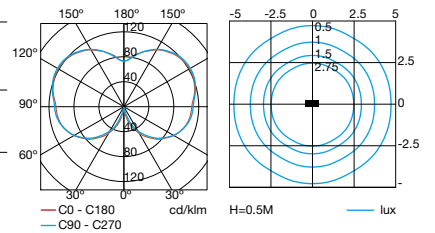

MANDELA

55-9606-Z5-M1 ■

E27 max. 23W | max. L 150mm
Fluo | A**... C

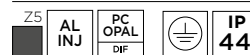

E27 18W

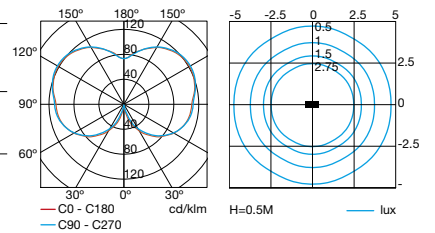



Delta'12 Awards
Silver



PILE

55-9555-34-CL

Led CREE 8W | 3000K | 752lm | A+... A

34 AL PUR PC MAT DIF IP 54 IK 10

EAGLE RISE

100-240V
50-60Hz



Led 8W

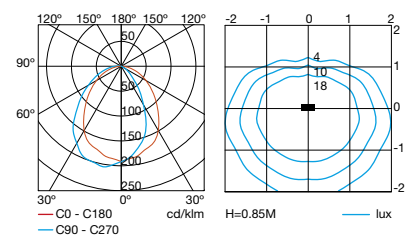

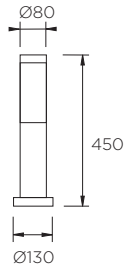

ELECTRA

10-8790-Y4-M1

E27 max. 23W | max. L 167mm Ø 55mm
Fluo | **A**... C**

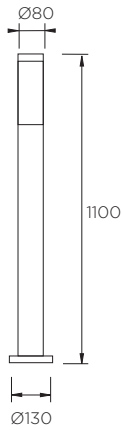

ELECTRA

55-8790-Y4-M1

E27 max. 23W | max. L 167mm Ø 55mm
Fluo | **A**... C**

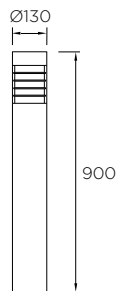

PRIAP

55-9317-Y4-M2

E27 max. 23W | max. L 152mm Ø 50mm
Fluo | **A**... C**



E27 23W

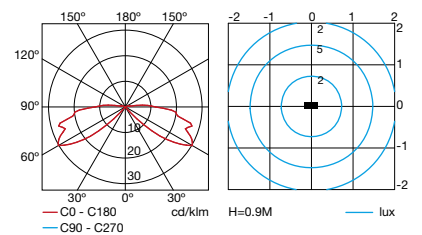

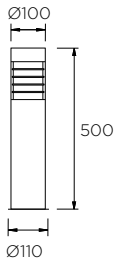

PRIAP

55-9239-CA-M2

E27 max. 23W | max. L 152mm Ø 50mm
Fluo | A**... C

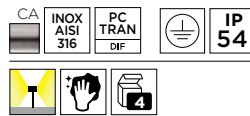

E27 23W

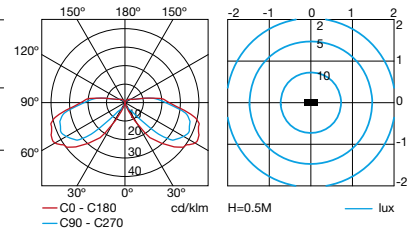

PRIAP

55-9440-CA-M2

E27 max. 23W | max. L 152mm Ø 50mm
Fluo | A**... C

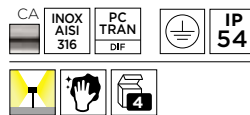

E27 23W

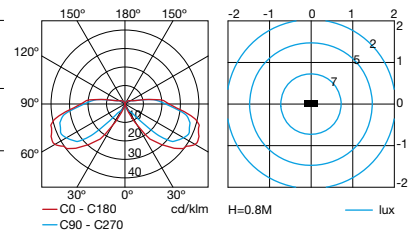

P.703

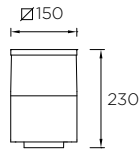

CUBIK

10-9386-34-M3

10-9386-K7-M3

10-9386-Z5-M3

E27 max. 60W | max. L 180mm
Hal - Fluo | A++... C

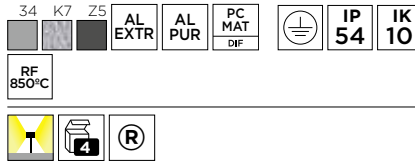

E27 13W

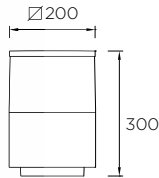
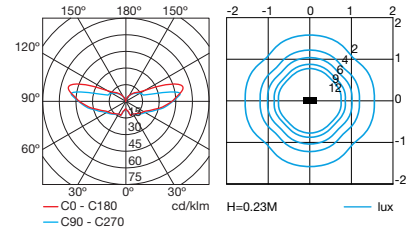

CUBIK

10-9387-34-M3

10-9387-K7-M3

10-9387-Z5-M3

E27 max. 100W | max. L 185mm
Hal - Fluo | A++... C

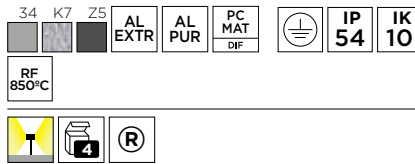

E27 18W

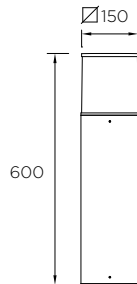
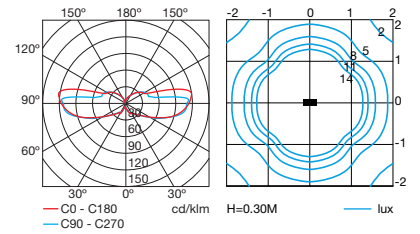

CUBIK

55-9488-34-M3

55-9488-Z5-M3

E27 max. 60W | max. L 180mm
Hal - Fluo | A++... C

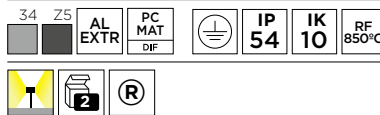

E27 13W

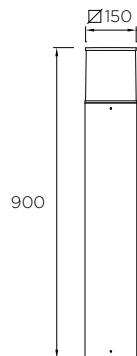
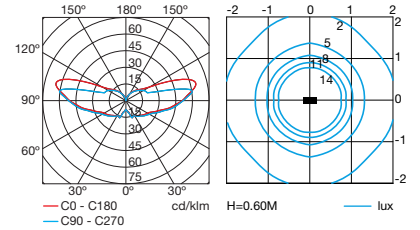

CUBIK

55-9549-34-M3

55-9549-Z5-M3

E27 max. 60W | max. L 180mm
Hal - Fluo | A++... C

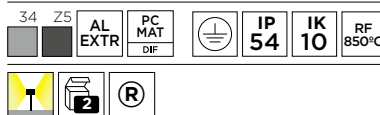

E27 13W

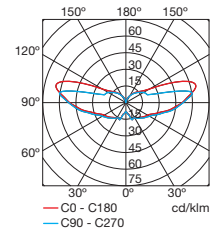

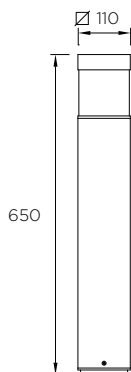

CUBASE

55-9690-34-M2

Led CREE 9W | 3000K | 648lm | A**... A

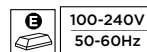
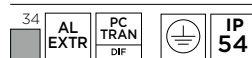

Led 9W

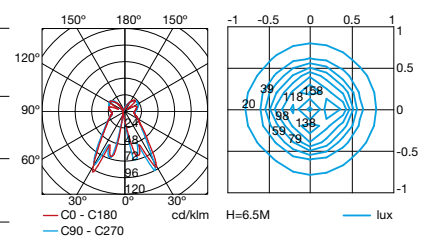

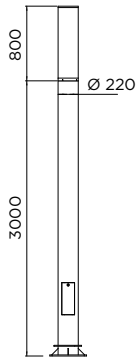

CITIZEN

83-3239-BB-M2

Led CITIZEN 60W | 3000K | 6082lm | A+... A

BB	AL INJ	PC TRAN DF		IP 65	IP 66	IK 10
MEAN WELL		100-240V 50-60Hz				
>50,000h	HIGH					



71-4520-48-48

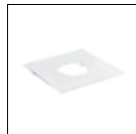

71-4525-48-48



71-4531-48-48

Led 60W 3000K
ULOR INST = 2,08%

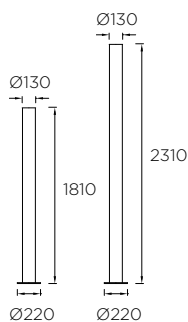
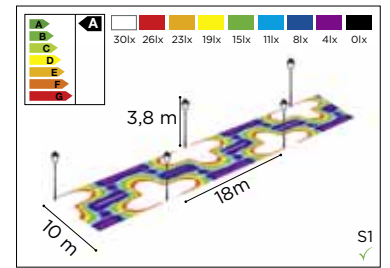
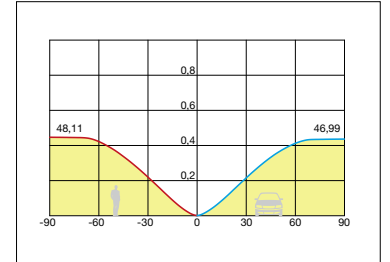
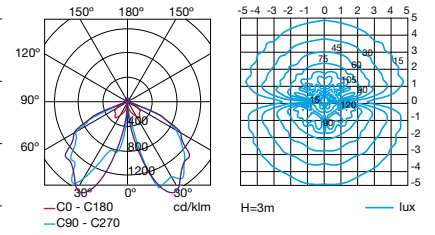

LYON



60-9809-34-CL

3000K | 5443lm

60-9809-34-CM

4000K | 6048lm

Led 48W | A+... A

34	AL PUR	PC OPAL DF		IP 65
LETARON		100-240V 50-60Hz		

Led 48W 3000K

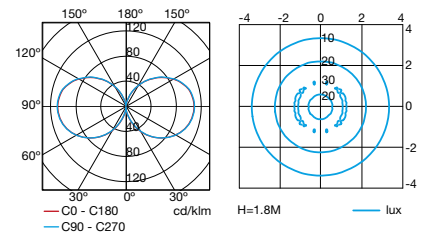

LYON



81-9914-34-34

H=1810

81-9915-34-34

H=2310 **NEW**

Columna / Column / Mât / Säule / Colonna / Coluna / Колонна / Stup

34	AL PUR

STREET LIGHTS



OUTDOOR | STREET LIGHTS

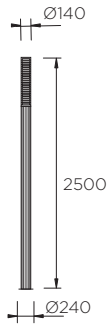

TEMIS

55-9431-34-M2

2 x Gx24q3/q4 26-32-42W | A**... B



2 x Gx24q-4 42W

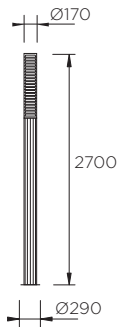
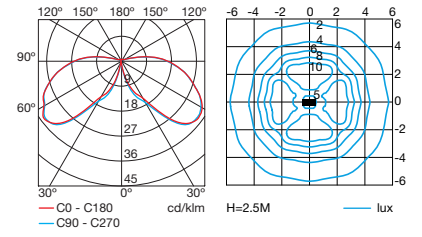

TEMIS

55-9268-34-M2

4 x 2G11 55W | A**... B



4 x 2G11 55W

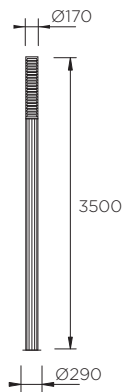
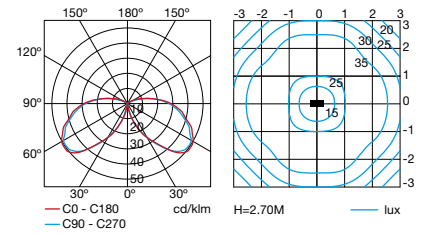

TEMIS

55-9269-34-M2

4 x 2G11 55W | A**... B



4 x 2G11 55W

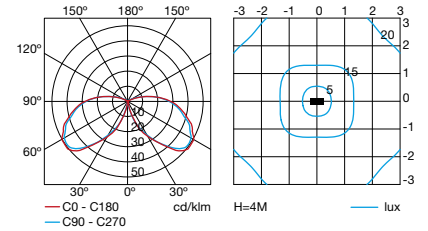

TEMIS

71-9514-52-52

Reflector direccional para / Directional reflector for / Réflecteur directionnel pour / Reflektor für / Riflettore direzionale per / Reflektor direccional para / Направленный отражатель для / Odbłyśnik kierunkowy dla / 55-9268, 55-9269

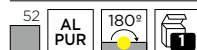



Reflectores anticontaminación lumínica.
Anti light pollution reflectors.
Réflecteurs anti-pollution lumineuse.
Reflektore für eine umweltfreundliche Beleuchtung
Riflettori anti-contaminazione luminica.
Reflectores que evitam a poluição luminosa.
Отражатели для предотвращения светового
загрязнения
Odbłyśniki zapobiegające zjawisku "light pollution"



Superficie estriada para evitar el pegado de adhesivos.
Slotted surface to prevent sticking of adhesives.
Surface striée pour éviter le collage d'adhésifs.
Gestreckte Oberflächen, um das Ankleben von Adhäsivmaterial zu vermeiden
Superficie striata per evitare l'attacco degli adesivi.
Superficie estriada para evitar a colagem de adesivos.
Рифленая поверхность для предотвращения размещения наклеек.
Powierzchnia szczelinowana uniemożliwiająca przyklejanie



Kit de instalación incluido.
Installation kit included.
Kit d'installation compris.
Einbaukit inklusive.
Kit installazione incluso.
Kit de instalação incluído.
Прилагается набор для установки
Zestaw montażowy w komplecie

SCAN-RAY

80-4970-BQ-M2



Led LUMILed 120W | 4000K | 12868lm | A++... A

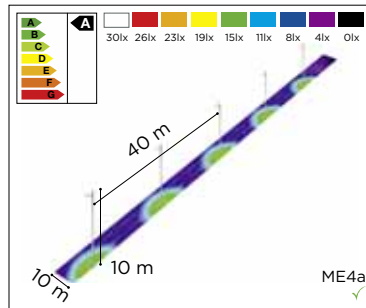
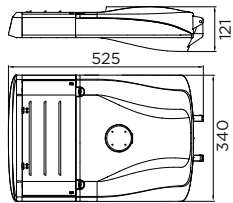
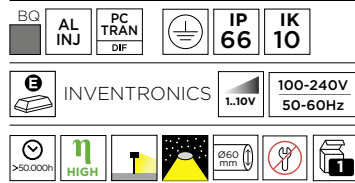

Led 120W 4000K
ULOR INST = 0,77%

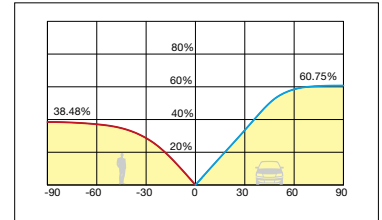
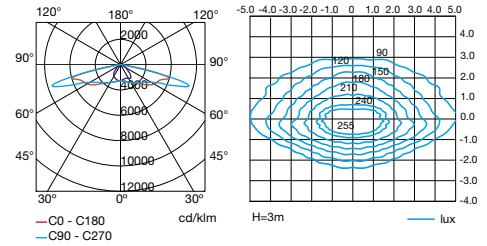

SCAN-RAY

80-4971-BQ-M2



Led LUMILed 180W | 4000K | 18231 lm | A++... A

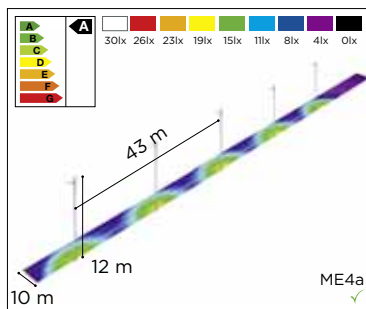
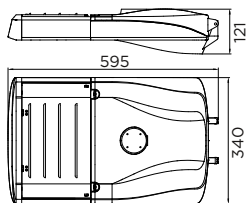
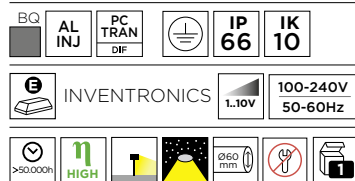

Led 180W 4000K
ULOR INST = 0,77%

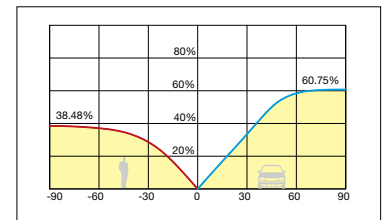
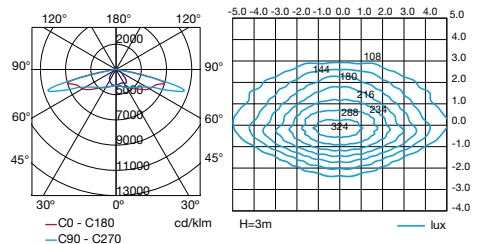

71-4554-AV-AV

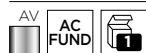

71-4554 / 55-9305

Producto fabricado en acero galvanizado por inmersión en caliente y no pintado, consultar para recibirlo en un acabado personalizado.
Product manufactured in hot dip galvanized steel, not painted, check to receive a custom finish.
Produit fabriqué en acier galvanisé par immersion à chaud et non peint. Finition personnalisée sur demande.
Hergestellt aus feuerverzinktem Stahl, nicht lackiert. Individuelle Ausführungen auf Anfrage.
Prodotto fabbricato in acciaio galvanizzato per immersione a caldo, non verniciato. Possibilità di fornirlo con finiture personalizzate.
Produto fabricado em aço galvanizado por imersão a quente e sem pintura, consultar para um acabamento personalizado.
Оцинкованная неокрашенная сталь. Изменение отделки возможно по запросу.
Produkt wykonany ze stali ocynkowanej ogniowo. Proszę się skonsultować w sprawach wykończeń personalizowanych.

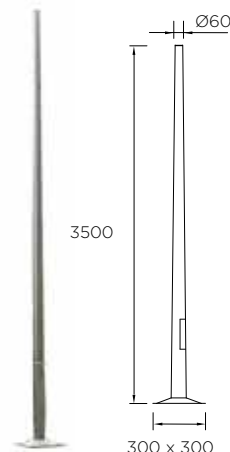

55-9305-48-48

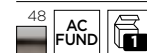

Kit de instalación incluido.
Installation kit included.
Kit d'installation compris.
Einbaukit inklusive.
Kit installazione incluso.
Kit de instalação incluso.
Прилагается набор для установки.
Zestaw montażowy w komplecie

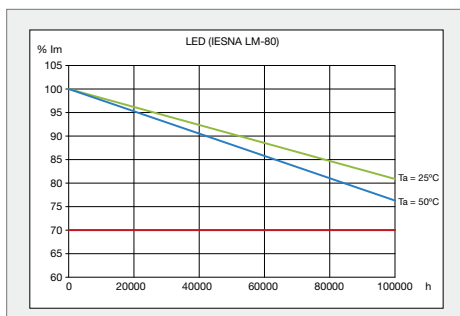

Protección sobretensiones 10kA. /
 Surge protection 10kA. /
 Protecteur de surtension 10kA. /
 Überspannungsschutz 10kA. /
 Protetto dalla sovretensione da 10kA. /
 Сетевой фильтр 10kA. /
 Zabezpieczenie Przeciwprzebiegowe 10kA. /

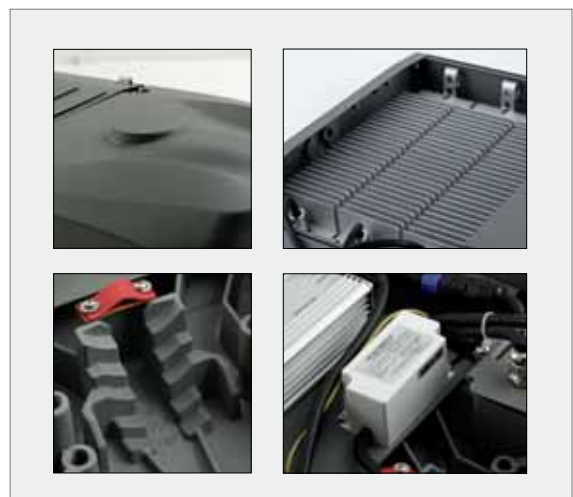



ELIPSE

80-4614-BQ-37 ■ 45W | 4379lm

80-5292-BQ-37 ■ 90W | 8231lm **NEW**

Led OSRAM | 4000K | A++... A



IK 08

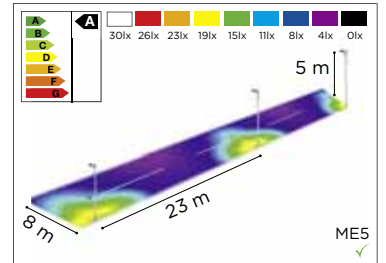
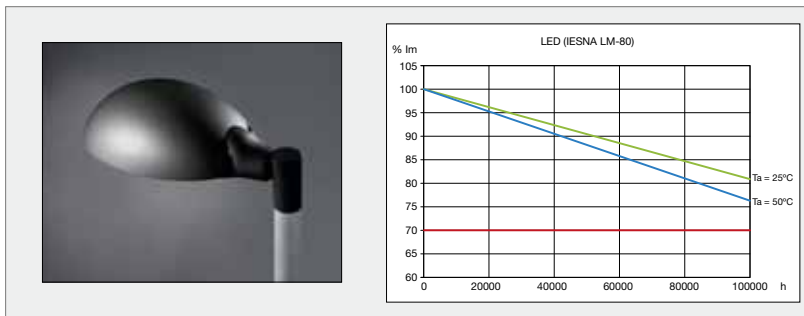
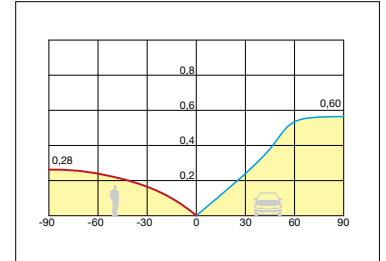
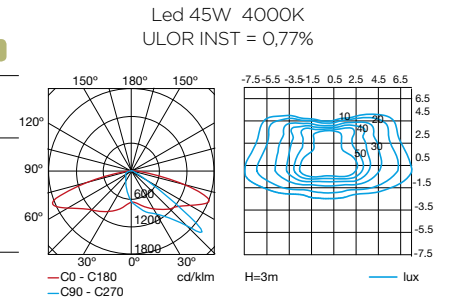
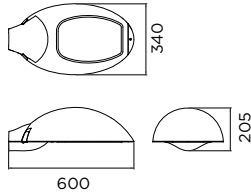
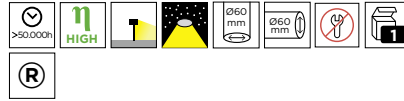

GLAVA

60-9842-34-CM ■

Led LG 55,5W | 4000K | 6468lm | A++... A

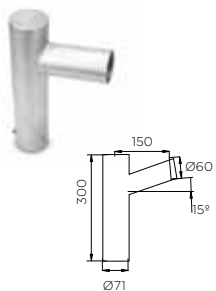
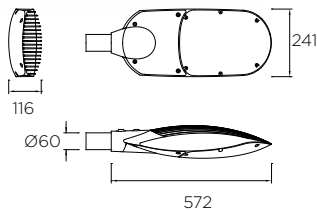
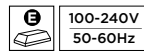

71-4554-AV-AV ■



Accesorio para / Accessory for / Accessoire pour / Zubehör für / Accessorio per / Acessório para / Принадлежность для / Akcesorium do 60-9842

55-9305-48-48 ■



Kit de instalación incluido. Installation kit included. Kit d'installation compris. Einbaukit inklusive. Kit installazione incluso. Kit de instalação incluso. Прилагается набор для установки. Zestaw montażowy w komplecie

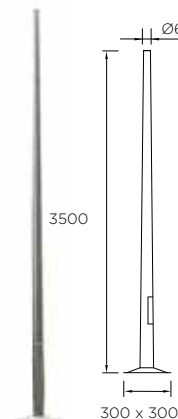

71-4554 / 55-9305

Producto fabricado en acero galvanizado por inmersión en caliente y no pintado, consultar para recibirlo en un acabado personalizado.
Product manufactured in hot dip galvanized steel, not painted, check to receive a custom finish.
Produit fabriqué en acier galvanisé par immersion à chaud et non peint. Finition personnalisée sur demande.
Hergestellt aus feuerverzinktem Stahl, nicht lackiert. Individuelle Ausführungen auf Anfrage.
Prodotto fabbricato in acciaio galvanizzato per immersione a caldo, non verniciato. Possibilità di fornirlo con finiture personalizzate.
Produto fabricado em aço galvanizado por imersão a quente e sem pintura, consultar para um acabamento personalizado.
Оцинкованная неокрашенная сталь. Изменение отделки возможно по запросу.
Produkt wykonany ze stali ocynkowanej ogniu. Proszę się skonsultować w sprawach wykończeń personalizowanych.



OUTDOOR | STREET LIGHTS

L' ESTANY. BARCELONA, SPAIN.



MERIDIAN ASYMMETRICAL

80-2427-BP-37 ■ 45W | 4379lm

80-5293-BP-37 ■ 90W | 8231lm **NEW**

Led OSRAM 4000K | A++... A

BP	AL INJ	GLA HARD DIF	IP 64	IP 66	IK 08
MEAN WELL	1.10V	100-240V	50-60Hz		
>50.000h	HIGH	Ø60 mm	IP 66	IK 08	®

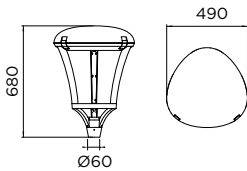

490

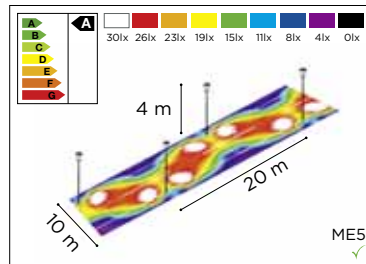

Led 45W 4000K
ULOR INST = 0,00%

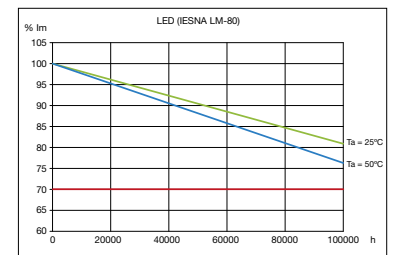
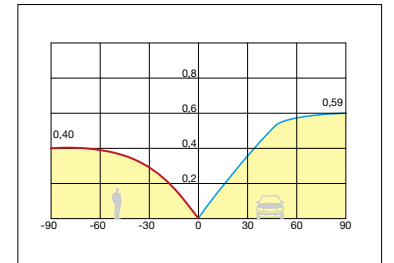
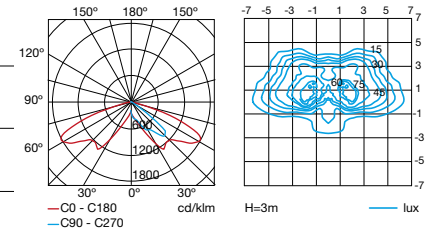

MERIDIAN SYMMETRICAL

80-4529-BP-37 ■ 45W | 4379lm

80-5294-BP-37 ■ 90W | 8231lm **NEW**

Led OSRAM | 4000K | A++... A

BP	AL INJ	GLA HARD DIF	IP 64	IP 66	IK 08
MEAN WELL	1.10V	100-240V	50-60Hz		
>50.000h	HIGH	Ø60 mm	IP 66	IK 08	®

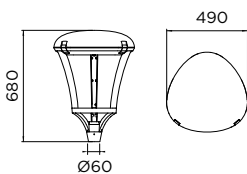

490

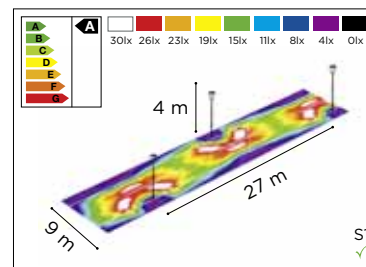

Led 45W 4000K
ULOR INST = 0,00%

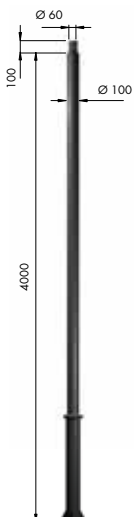
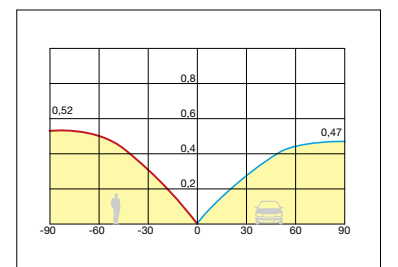
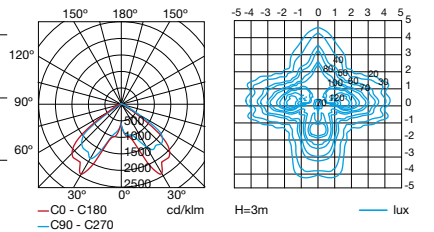

NIKOLSON

81-3145-BP-BP ■

BP	AC FUND	IK 10	4m	Ø60 mm	IP 66
----	---------	-------	----	--------	-------



71-4520-48-48

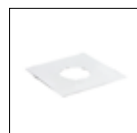

71-4524-48-48



71-4531-48-48

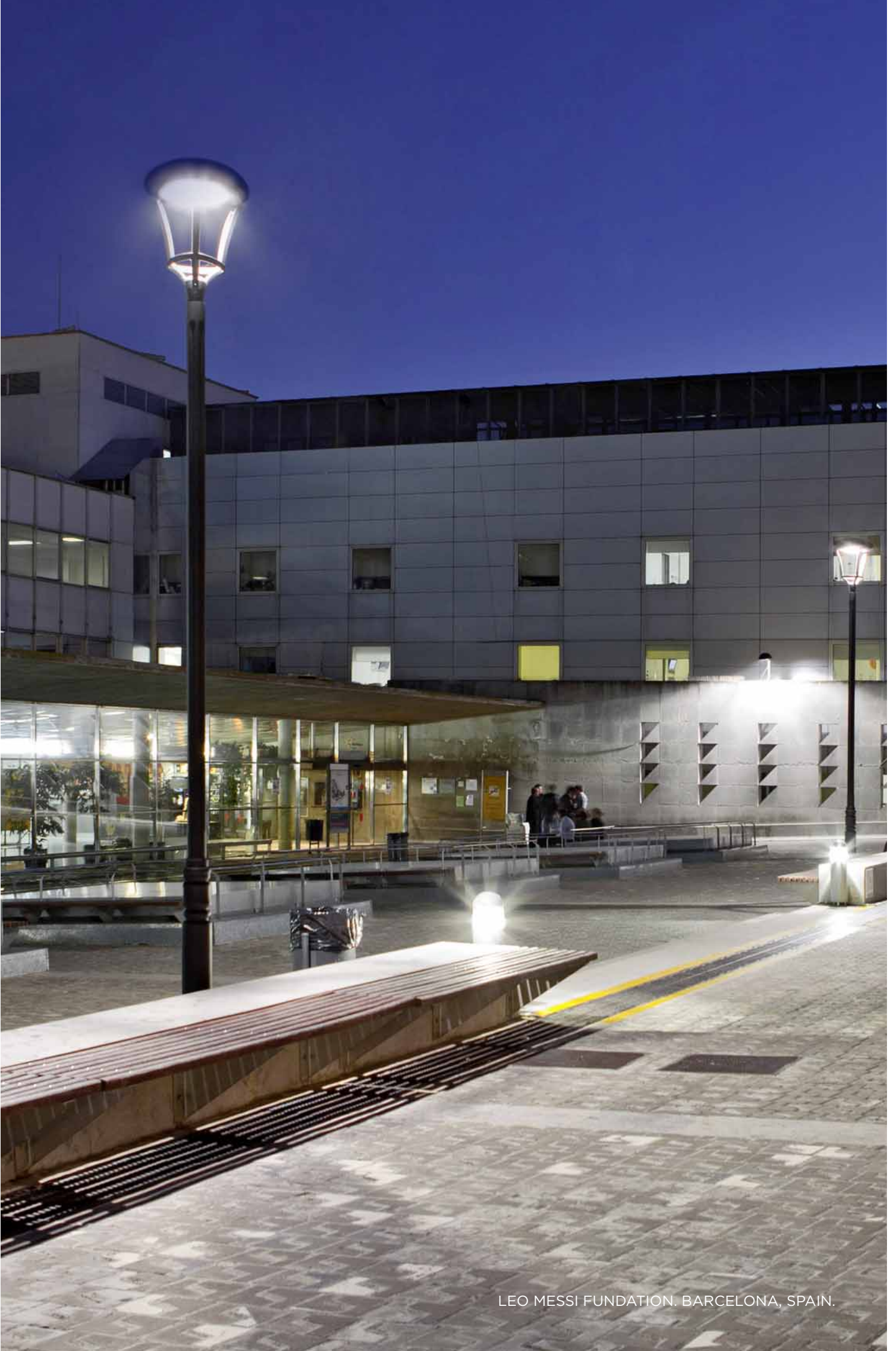

OUTDOOR | STREET LIGHTS

LEO MESSI FOUNDATION. BARCELONA, SPAIN.

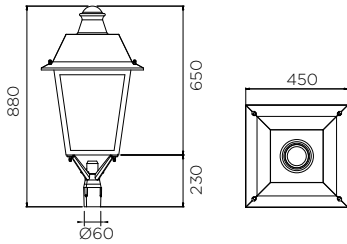

BOHEMIA

80-4528-BP-37 ■ 45W | 4379lm

80-5295-BP-37 ■ 90W | 8231lm **NEW**

Led OSRAM | 4000K | A++... A

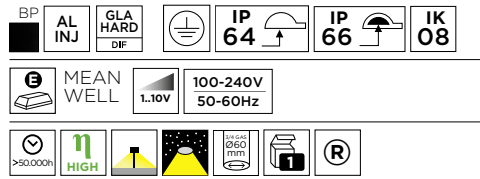

Led 45W 4000K
ULOR INST = 1,20%

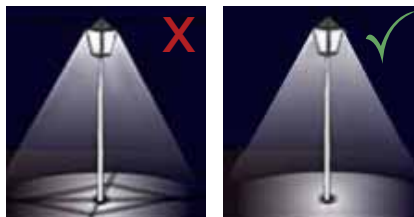
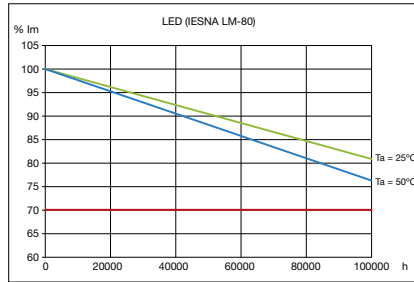
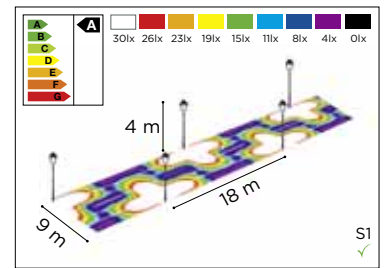
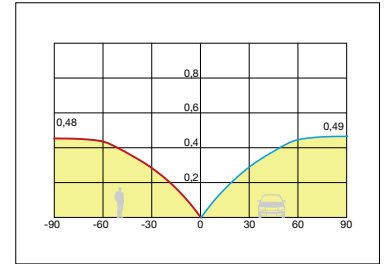
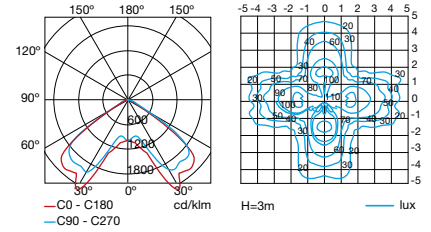

Sistema exclusivo de LEDS-C4 para reducir la proyección de sombras.

Exclusive LEDS-C4 system to reduce shadows.

Système exclusif de LEDS-C4 destiné à réduire la projection d'ombres.

Exklusives System von LEDS-C4 zur Verringerung von Schattenwurf.

Sistema esclusivo di LEDS-C4 per ridurre la proiezione di ombre.

Sistema exclusivo de LEDS-C4 para reduzir a projeção de sombras.

Эксклюзивная система LEDS-C4 для уменьшения отбрасывания теней.

Ekskluzywny system LEDS-C4 dla zmniejszenia rzucania cieni.

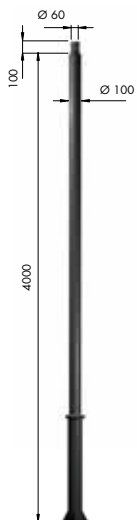

NIKOLSON

81-3145-BP-BP ■

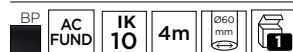

71-4520-48-48

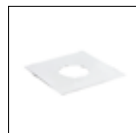

71-4524-48-48



71-4531-48-48



OUTDOOR | STREET LIGHTS

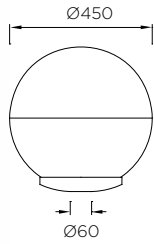

HEADS



60-9482-Z5-M2 ■

E-27 max. 100W | L 180mm
Hal - Fluo | A++... C

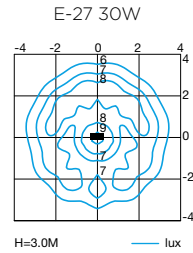

POMPEYA

71-9291-34-34 (S) ■

Soporte para instalación en poste de diámetro 60mm para usar con los cabezales Pompeya: / Supporting bracket for use with 60mm diameter post installation. To be used with Pompeya heads: / Support à installer sur un mât de 60 mm de diamètre à utiliser avec les têtes Pompeya: / Halterung an Masten mit 60 mm Durchmesser zur Verwendung mit den Köpfen Pompeya: / Supporto per installazione su palo di diametro 60mm da utilizzare con testata Pompeya: / Suporte para instalação em poste com diâmetro de 60 mm para usar com as cabeças Pompeya: / Крепление для установки на столбе диаметром 60 мм для использования головок Помпея: / Wspornik dla instalacji na słupku o średnicy 60mm do użycia z głowicami Pompeya: / 05-9251, 05-9537, 05-9538, 05-9539, 05-9254

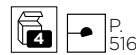

POMPEYA

71-9292-34-34 (S) ■

Soporte para instalación en poste de diámetro 60mm para usar con los cabezales Pompeya: / Supporting bracket for use with 60mm diameter post installation. To be used with Pompeya heads: / Support à installer sur un mât de 60 mm de diamètre à utiliser avec les têtes Pompeya: / Halterung an Masten mit 60 mm Durchmesser zur Verwendung mit den Köpfen Pompeya: / Supporto per installazione su palo di diametro 60mm da utilizzare con testata Pompeya: / Suporte para instalação em poste com diâmetro de 60 mm para usar com as cabeças Pompeya: / Крепление для установки на столбе диаметром 60 мм для использования головок Помпея: / Wspornik dla instalacji na słupku o średnicy 60mm do użycia z głowicami Pompeya: / 05-9251, 05-9537, 05-9538, 05-9539, 05-9254

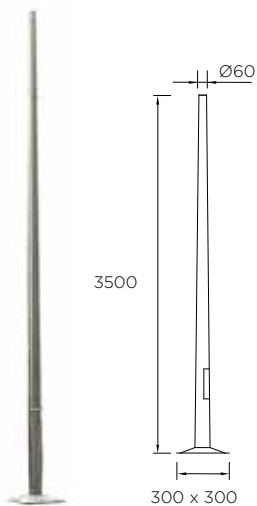
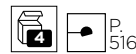

55-9305-48-48 ■



Kit de instalación incluido. Installation kit included. Kit d'installation compris. Einbaukit inklusive. Kit installazione incluso. Kit de instalação incluído. Прилагается набор для установки. Zestaw montażowy w komplecie

55-9305

Producto fabricado en acero galvanizado por inmersión en caliente y no pintado, consultar para recibirlo en un acabado personalizado. Product manufactured in hot dip galvanized steel, not painted, check to receive a custom finish. Produit fabriqué en acier galvanisé par immersion à chaud et non peint. finition personnalisée sur demande. Hergestellt aus feuerverzinktem Stahl, nicht lackiert. Individuelle Ausführungen auf Anfrage. Prodotto fabbricato in acciaio galvanizzato per immersione a caldo, non verniciato. Possibilità di fornirlo con finiture personalizzate. Produto fabricado em aço galvanizado por imersão a quente e sem pintura, consultar para um acabamento personalizado. Оцинкованная неокрашенная сталь. Изменение отделки возможно по запросу. Produkt wykonany ze stali ocynkowanej ogniu. Proszę sie skonsultować w sprawach wykończeń personalizowanych.

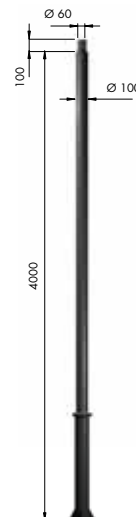

NIKOLSON

81-3145-BP-BP ■



71-4520-48-48



71-4524-48-48



71-4531-48-48

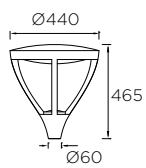

PROUD NEW

60-9913-Z5-CM ■

Led 38W | 4000K | 4612lm | A**... A

Z5	AL PUR	PC MAT DIF		IP 65	IK 10	RF 850°C
	EAGLE RISE	100-240V 50-60Hz				



AQUA

05-9727-05-CMV1 ■

Led CREE 7W | 4000K | 489lm | A**... A

05 PC PC TRAN DIF IP 68 1m IK 09

12 VAC P.691 12 VDC P.690

2,5 m ±45° 45° 12 R

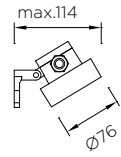

Led 7W

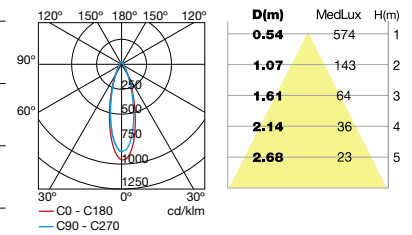

AQUA

05-9728-05-CMV1 ■

Led CREE 21W | 4000K | 1467lm | A**... A

05 PC PC TRAN DIF IP 68 1m IK 09

12 VAC P.691 12 VDC P.690

2,5 m ±45° 45° 12 R

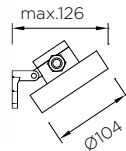

Led 21W

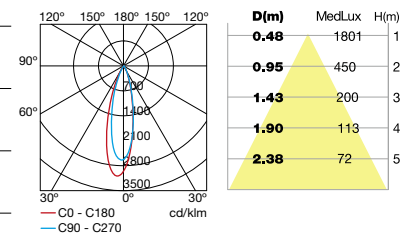

AQUA

05-9245-CA-37V1 ■

GU5.3 max. 50W | max. L 55mm
Hal - Fluo | A**... C

CA INOX AISI 316 GLA HARD DIF IP 68 1m IK 10 RF 850°C

0,5M

12 VAC P.691

2,5 m 360° ±45° 12 R

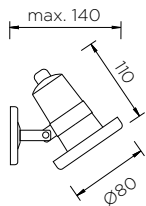

GU5.3 50W

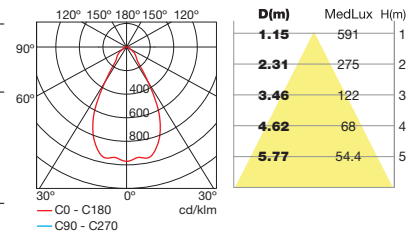

AQUA

05-9889-CA-CM ■ **NEW**

Led LG 5W | 4000K | 663lm | A**... A

CA INOX AISI 316 GLA HARD DIF IP 68 1m IK 10 RF 850°C

12 VAC P.691

2,5 m 360° ±45° 12 R

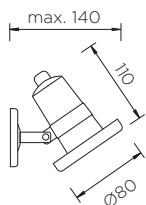

Led 5W

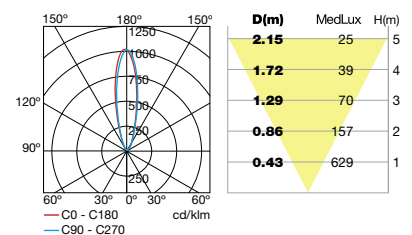

P.703

WATERPROOF

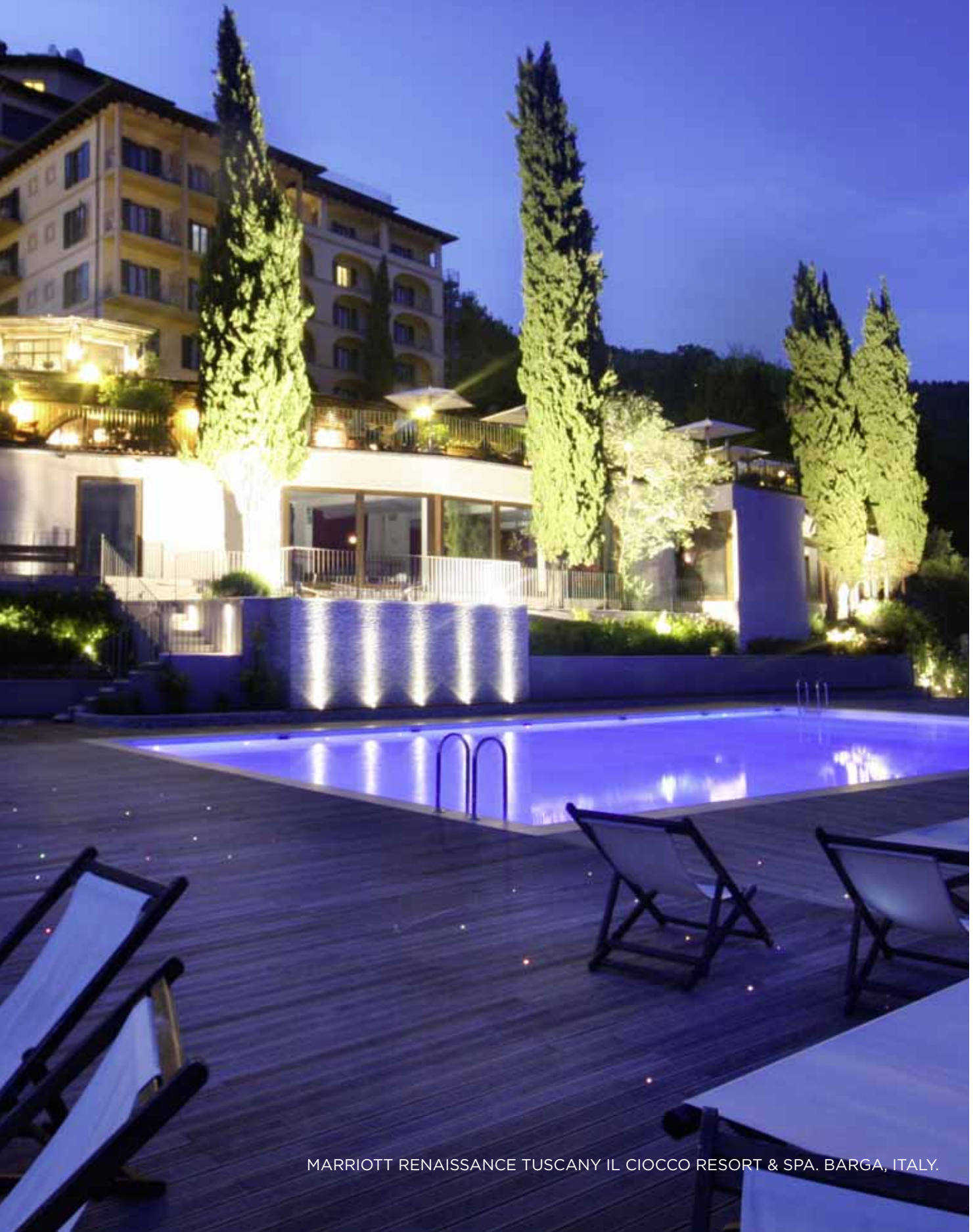

OUTDOOR | WATERPROOF

MARRIOTT RENAISSANCE TUSCANY IL CIOCCO RESORT & SPA. BARGA, ITALY.

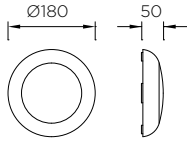

AQUA

55-9697-14-M3

Led PHILIPS 6W | 4000K | 549lm | <40°C | A**... A

14 PC PC MAT DIF IP 68 1m IK 07

~~12 VAC~~ P.691 ~~12 VDC~~ P.690

2,5 m 5M² 4 R

Led 6W

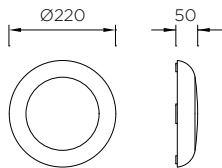
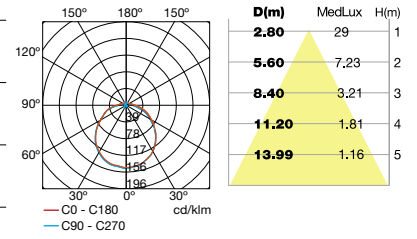

AQUA

55-9699-14-M3

Led PHILIPS 18W | 4000K | 1647lm | <40°C | A**... A

14 PC PC MAT DIF IP 68 1m IK 07

~~12 VAC~~ P.691 ~~12 VDC~~ P.690

2,5 m 15M² 4 R

Led 18W

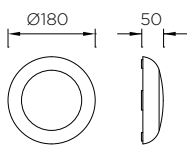
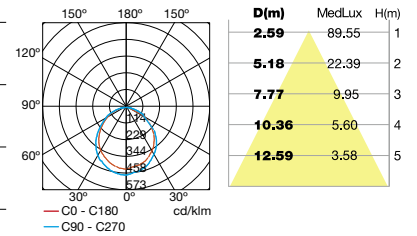

AQUA

55-9818-14-M3

Led CREE 6W | RGBEASY+ | 240lm | <40°C | A**... A

14 PC PC MAT DIF IP 68 1m IK 07

~~12 VAC~~ P.694

2,5 m 5M² 4 R

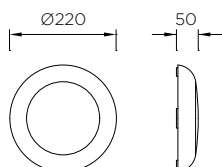

AQUA

55-9819-14-M3

Led CREE 10W | RGBEASY+ | 490lm | <40°C | A**... A

14 PC PC MAT DIF IP 68 1m IK 07

~~12 VAC~~ P.694

2,5 m 15M² 4 R

Led 10W

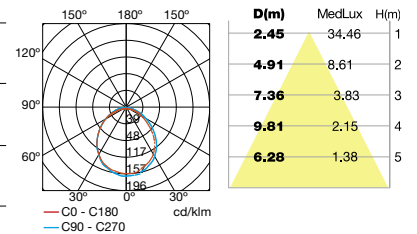

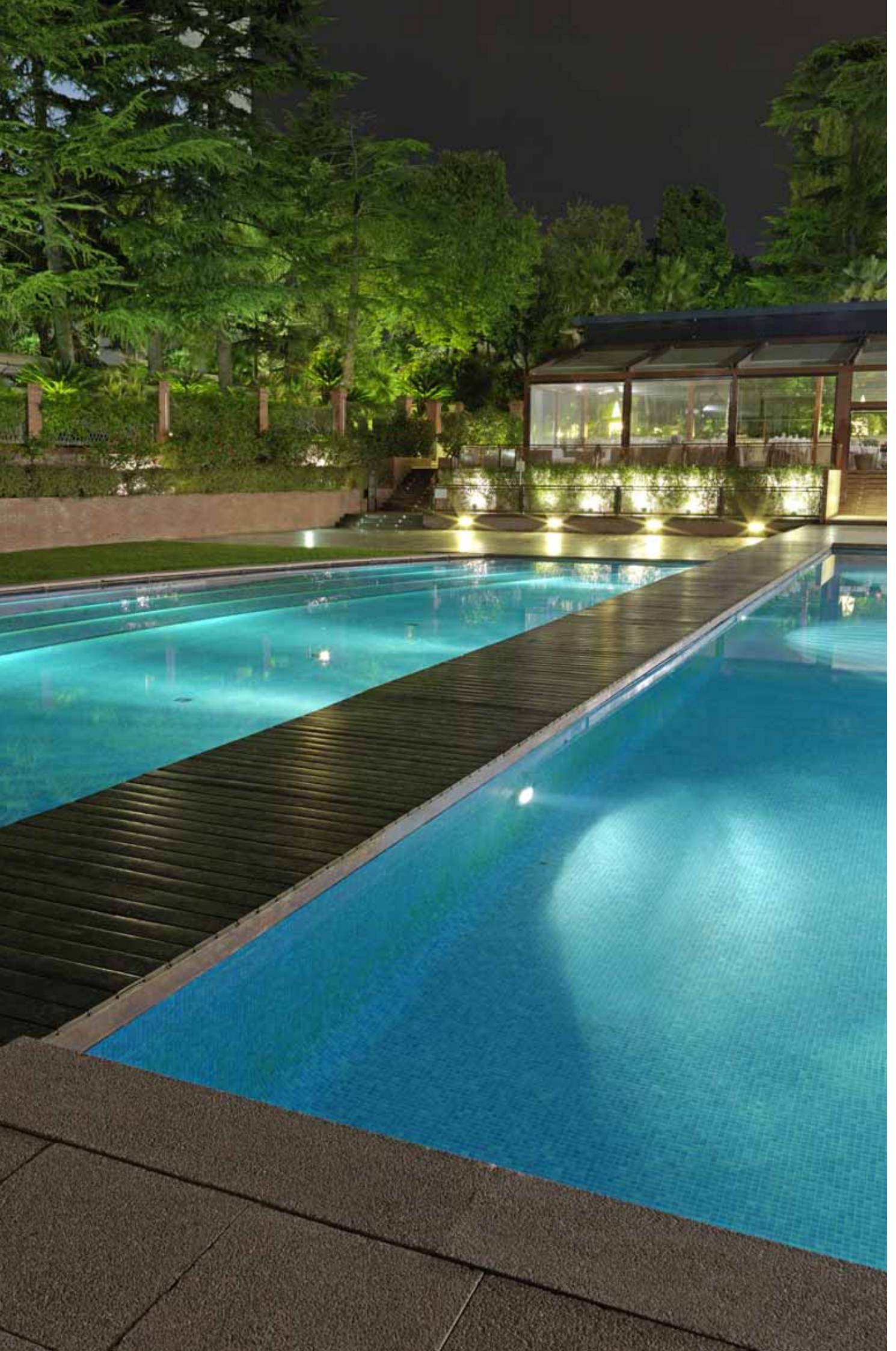

OUTDOOR | WATERPROOF

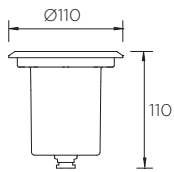

AQUA

55-9245-CA-37V1

GU5.3 max. 50W | max. L 60mm
Hal | **>80°C** | A**... C

CA	INOX AISI 316	GLA HARD DIF	IP 68	1m	IK 08	RF 850°C
	12 VAC	P.691				
	2,5 m					

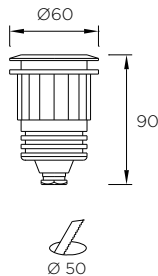
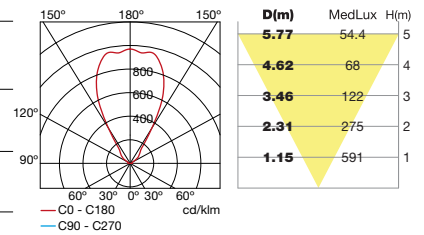

AQUA

55-9622-14-CMV1

Led CREE /1W 350mA | 107lm / 3W | 700mA | 184lm
| 4000K | **<40°C** | A**... A

14	PC	GLA HARD DIF	IP 68	1m	IK 10	
	B	P.682	max. 700 mA			
	2,5 m					

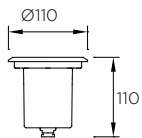
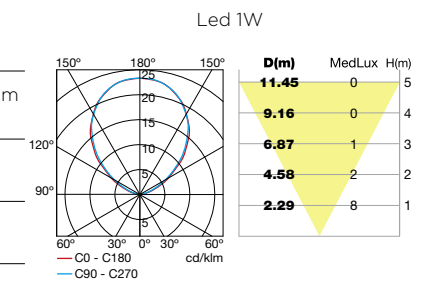

AQUA

55-9792-CA-CM

Led LG 5W | 4000K | 663lm | A**... A

CA	INOX AISI 316	GLA HARD DIF	IP 68	1m	IK 10	
	12 VAC	P.691		12 VDC	P.690	
	25°	5 m				

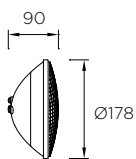
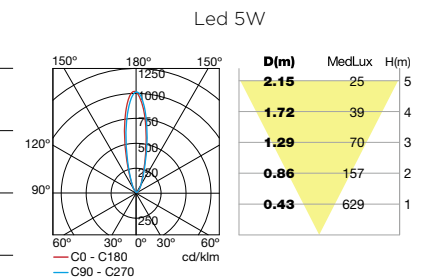

AQUA

71-9729-54-M3

Led SAMSUNG 43W | 4000K | 4320lm

54	PC	AL ANOD	PC MAT DIF	IP 68	1m	IK 10
	12 VAC	P.691		12 VDC	P.690	
	30M2					

Para substituir lâmpara PAR 56. | To replace PAR 56 bulb.
| Pour remplacer l'ampoule PAR 56. | Um Lampe PAR 56 ersetzen. | Per sostituire la lampadina PAR 56. | Para substituir lâmpada PAR 56. | Для замены лампы PAR 56. | Aby wymienić żarówkę 56 PAR.



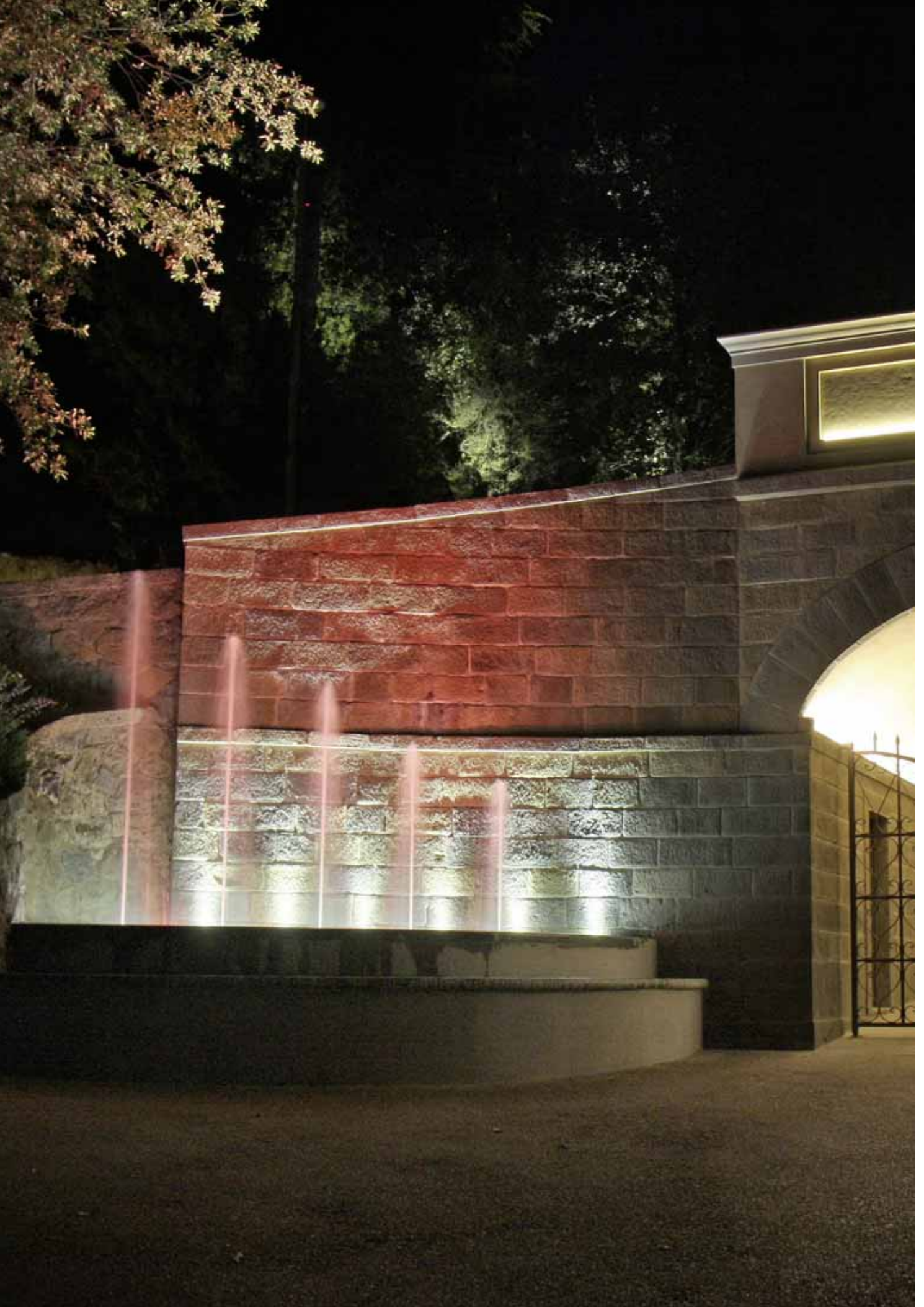

OUTDOOR | WATERPROOF

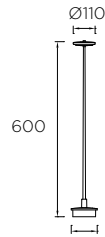

INVISIBLE

55-9733-05-M1 ■

Led 9W | 3000K | 864lm | A++... A

05	AL PUR	PC OPAL DIF	□	IP 54	IK 04
----	-----------	-------------------	---	----------	----------

	EAGLE RISE	100-240V 50-60Hz
--	------------	---------------------

--	--	--	--	--	--

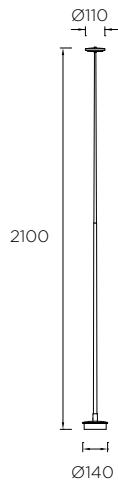
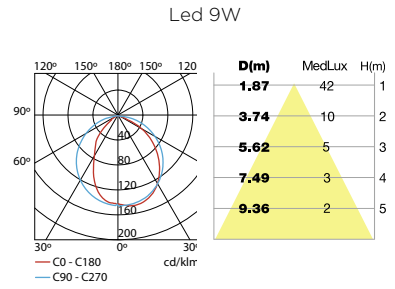

INVISIBLE

25-9733-05-M1 ■

Led 9W | 3000K | 864lm | A++... A

05	AL PUR	PC OPAL DIF	□	IP 54	IK 04
----	-----------	-------------------	---	----------	----------

	EAGLE RISE	100-240V 50-60Hz
--	------------	---------------------

--	--	--	--	--

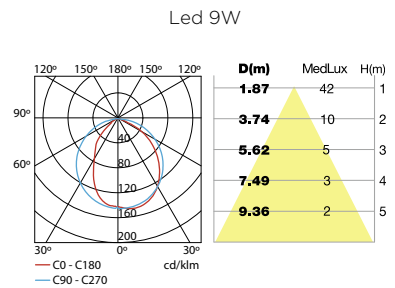

CHILLOUT

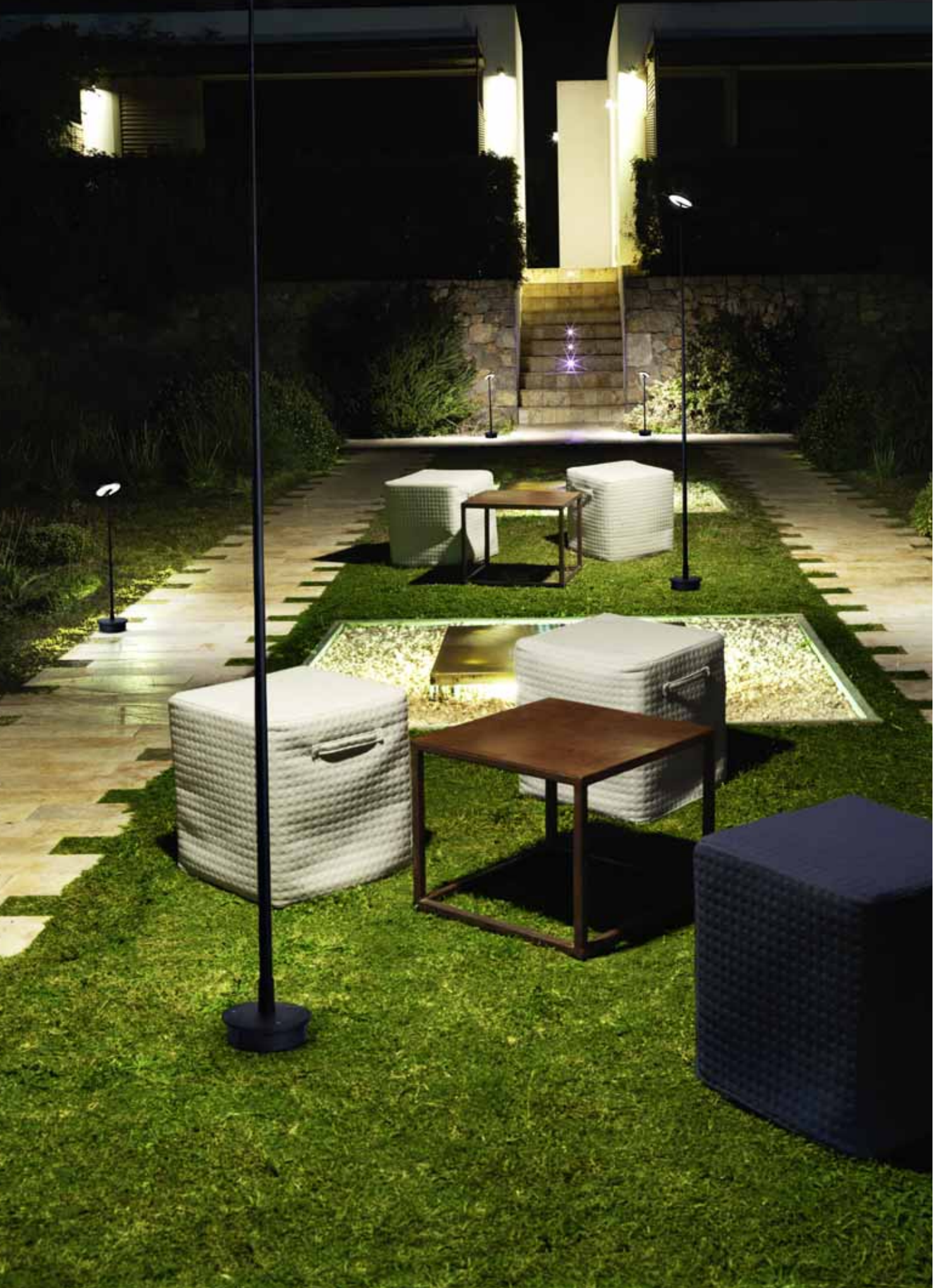

OUTDOOR | CHILLOUT

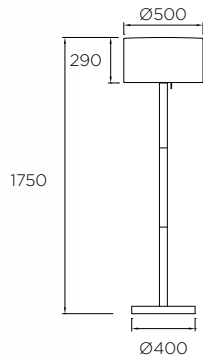
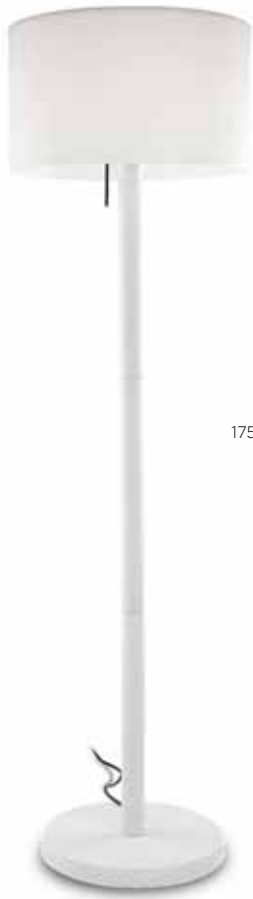

SMOOTH

25-9642-14-M1 (S)

Led 5W | RGB | A**... A

+
E27 max. 30W | max. L 170mm

Fluo | A**... B

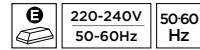

Interruptor incluido./ Switch included./ Interrupteur fourni./ Inkl. Schalter./ Interruttore incluso./ Interruptor incluido./ комплект входит выключатель. / Zawiera wyłącznik.

Base para fijar al suelo incluida./ Base for fixing in the ground included./ Socle à fixer au sol fourni./ Bodenplatte zur Befestigung am Boden mitgeliefert./ Base di fissazione a pavimento inclusa./ Base para fixar ao chão incluída./ основа для фиксации к полу./ Zawarta podstawa do przymocowania do podłogi.

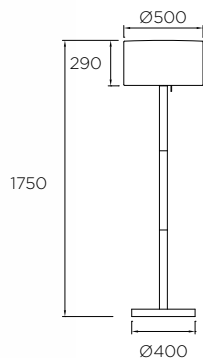
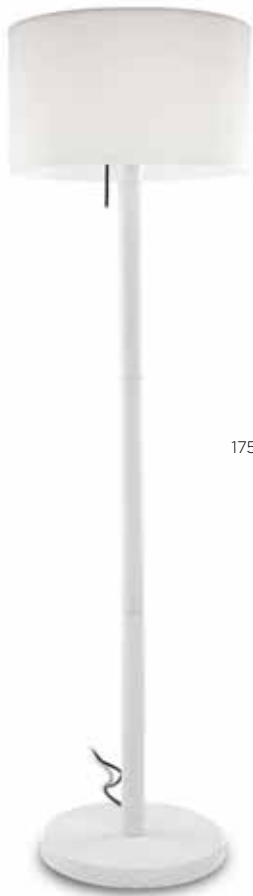

SMOOTH

25-9614-14-M1

E27 max. 100W | max. L 170mm

Hal - Fluo | A**... C



Interruptor incluido./ Switch included./ Interrupteur fourni./ Inkl. Schalter./ Interruttore incluso./ Interruptor incluido./ комплект входит выключатель. / Zawiera wyłącznik.

Base para fijar al suelo incluida./ Base for fixing in the ground included./ Socle à fixer au sol fourni./ Bodenplatte zur Befestigung am Boden mitgeliefert./ Base di fissazione a pavimento inclusa./ Base para fixar ao chão incluída./ комплект входит основа для фиксации к полу./ Zawarta podstawa do przymocowania do podłogi.

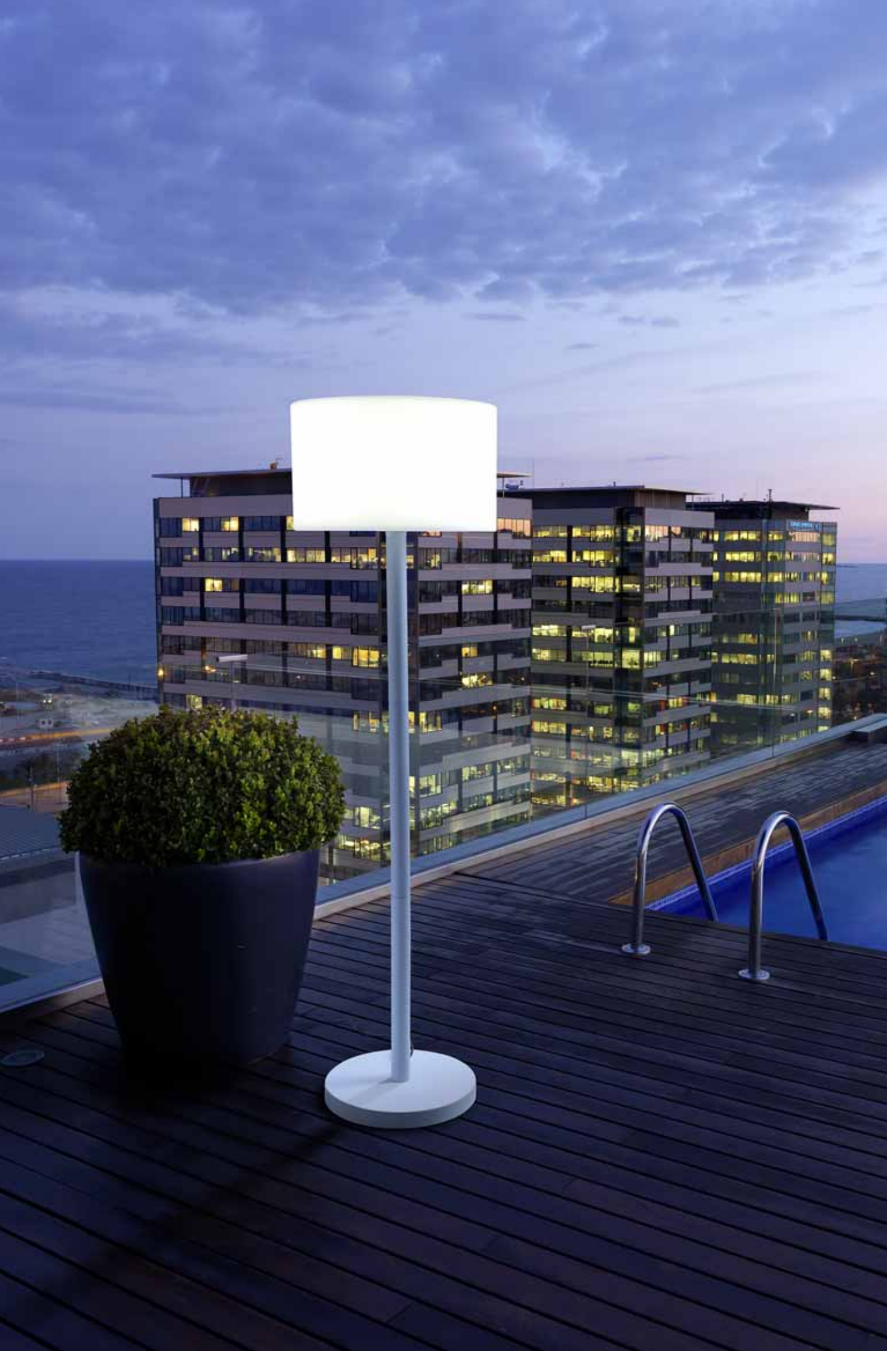

OUTDOOR | CHILLOUT

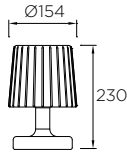

MOONLIGHT

10-9874-M1-M1

Led 1W | RGB | A+... A

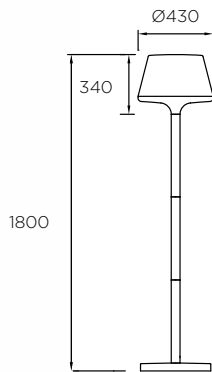
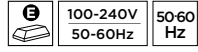
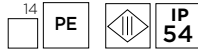

MOONLIGHT

25-9503-14-M1

25-9503-Z5-M1

E27 max. 100W
Hal - Fluó | A+... C

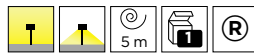

Incluye interruptor y pantalla opaca./ Includes switch and opaque screen./ Comprend interrupteur et abat-jour opaque./ Einschließlich Schalter und opakem Schirm./ Contiene interruttore e schermo opaco./ Inclui interruptor e quebra-luz opaco./ В комплект входит выключатель и непрозрачный абажур./ Zawiera wyłącznik i nieprzezroczysty abażur.

Base para fijar al suelo incluida./ Base for fixing to ground included./ Socle à fixer au sol fourni./ Bodenplatte zur Befestigung am Boden mitgeliefert./ Base da fissare nel pavimento inclusa./ Base para fixar ao chão incluída./ В комплект входит основа для фиксации к полу./ Zawarta podstawa do przymocowania do podłogi.



25-9503-Z5-M1



25-9503-14-M1



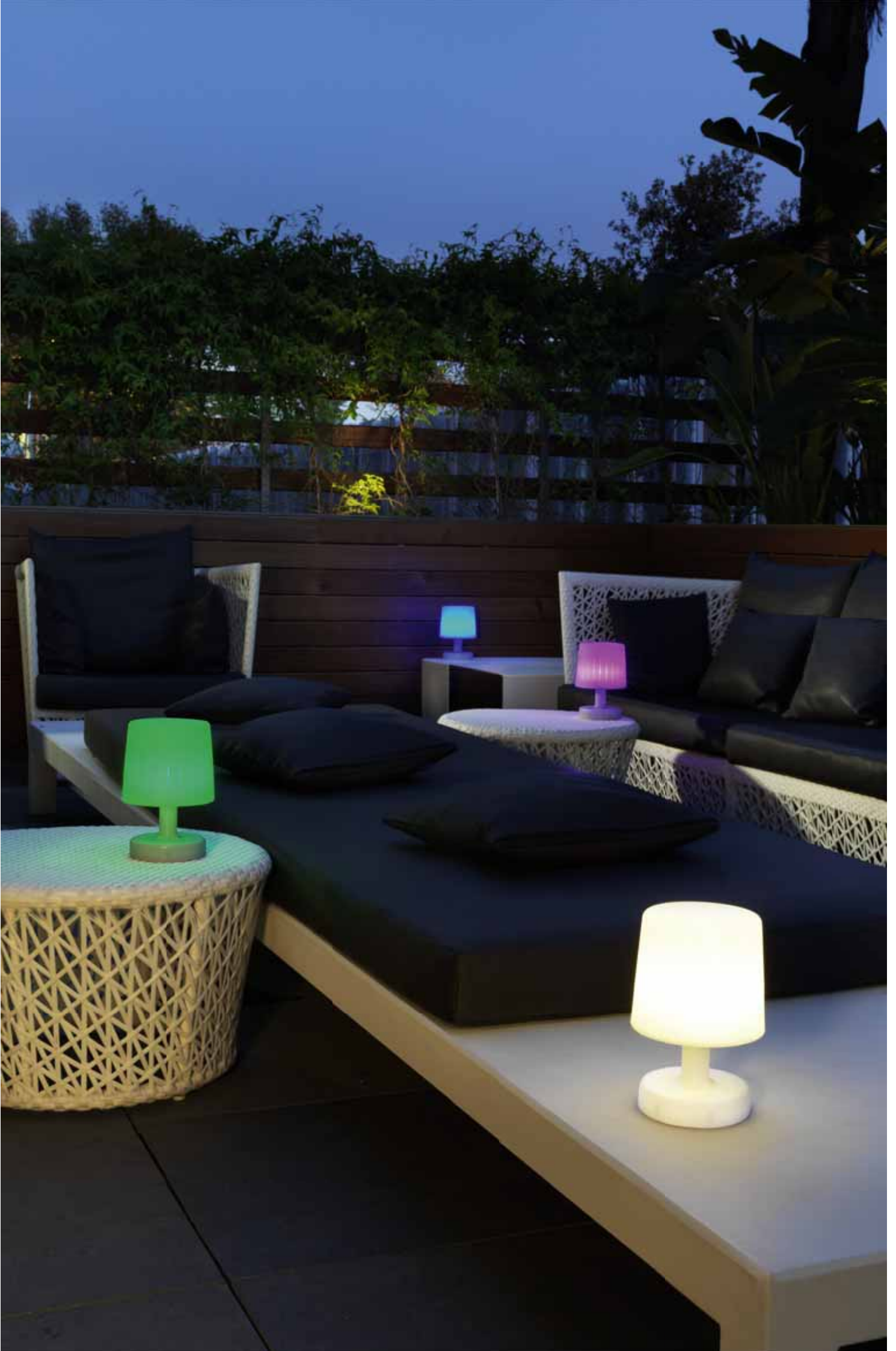

OUTDOOR | CHILLOUT



KAP

00-9669-14-M1

4 x E27 max. 13W | max. L 120mm Ø 50mm
Fluo | A++... C

14	PE	<input type="checkbox"/>	IP 44	IK 08

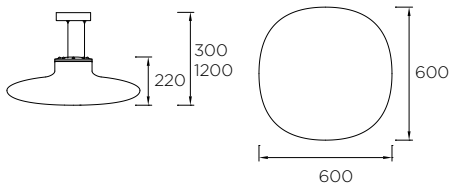

KAP

55-9669-14-M1

4 x E27 max. 13W | max. L 120mm Ø 50mm
Fluo | A++... C

M1	PE	<input type="checkbox"/>	IP 65	

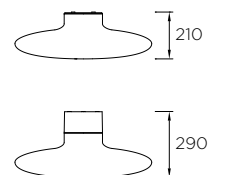
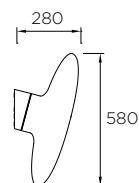
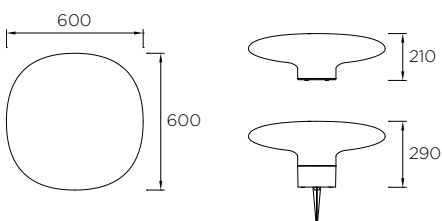



OUTDOOR | CHILLOUT

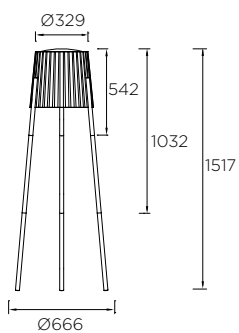

BARCINO NEW



55-9880-Z5-M1

E27 max. 100W
Fluo | A**... C



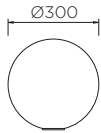

CISNE

55-9155-M1-M1

E27 max. 100W

Hal - Fluo | A++... C

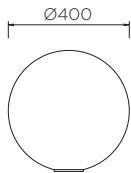
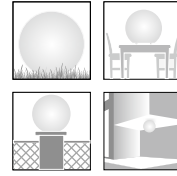

CISNE

55-9156-M1-M1

E27 max. 150W

Hal - Fluo | A++... C

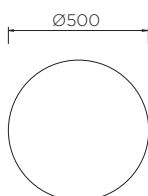
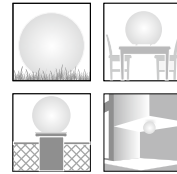

CISNE

55-9481-M1-M1

E27 max. 150W

Hal - Fluo | A++... C

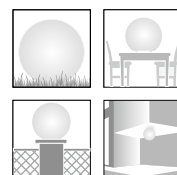

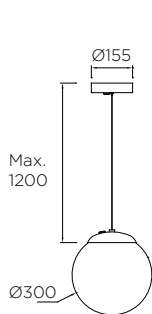

CISNE

00-9155-14-M1

E27 max. 100W

Hal - Fluo | A**... C

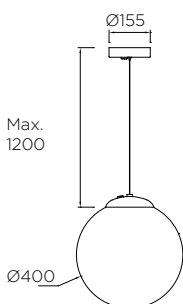

CISNE

00-9156-14-M1

E27 max. 150W

Hal - Fluo | A**... C



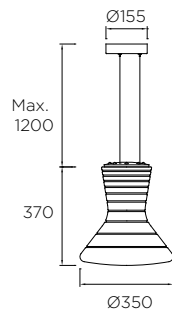

JEMBE

00-9796-14-M1 (S)

E27 max. 23W | max. L 150mm
Fluo | A**... C

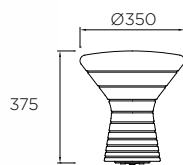
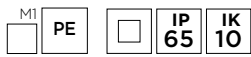

JEMBE

55-9796-M1-M1 (S)

E27 max. 23W | max. L 150mm
Fluo | A**... C

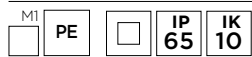

CLASSIC



OUTDOOR | CLASSIC



VINTAGE

10-9774-CC-CD ■

Led 13,5W | 3000K | 1209lm | A**... A

CC AL PUR PC MAT DIF IP 54 IK 06

EAGLE RISE 100-240V 50-60Hz

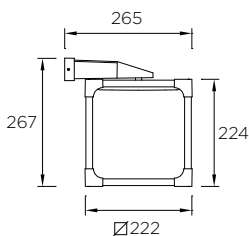
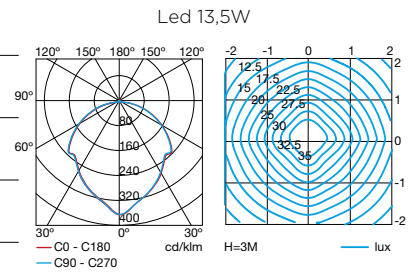

VINTAGE

05-9774-CC-CD ■

Led 13,5W | 3000K | 1209lm | A**... A

CC AL PUR PC MAT DIF IP 54 IK 04

EAGLE RISE 100-240V 50-60Hz

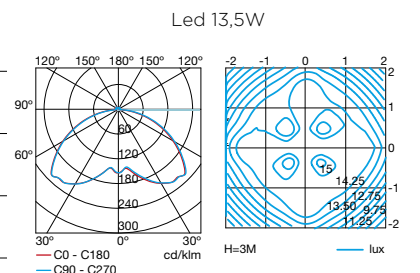

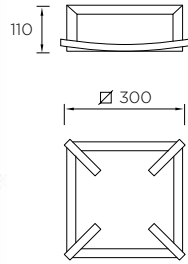

MARK

15-9298-Z5-M3 ■

2 x E27 max. 60W | max. L 167mm Ø 50mm
Hal - Fluo | A**... C

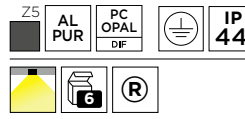

2 x E27 23W

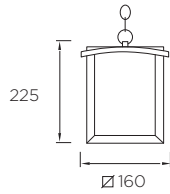
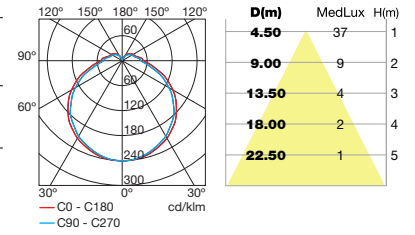

MARK

00-9298-14-M1 □ PC OPAL

00-9298-Z5-M3 ■ PC MAT

E27 max. 100W | max. L 150mm
Hal - Fluo - Led | A**... C

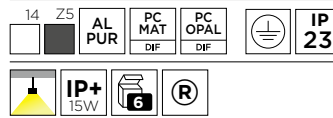

E27 18W

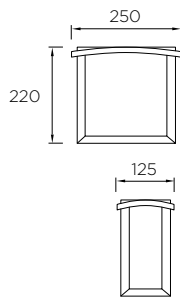
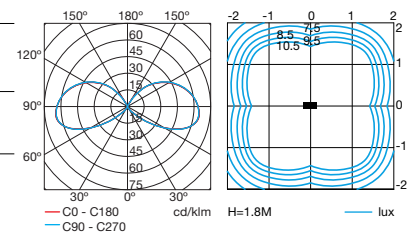

MARK

05-9299-Z5-M3 ■

2 x E27 max. 60W | max. L 150mm Ø 50mm
Hal - Fluo - Led | A**... C

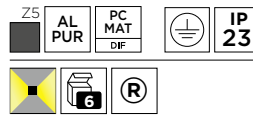

E27 18W

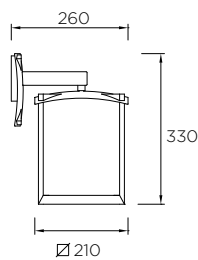
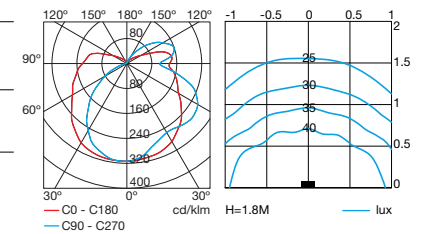

MARK

05-9390-Z5-M3 ■

E27 max. 100W | max. L 200mm
Hal - Fluo - Led | A**... C

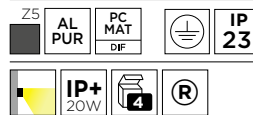

E27 30W

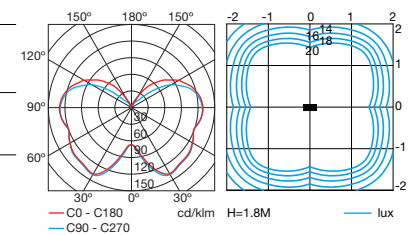

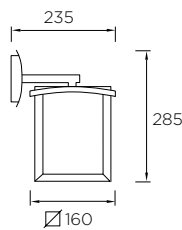

MARK

05-9298-14-M1

□ PC OPAL

05-9298-Z5-M3

■ PC MAT

E27 max. 100W | max. L 150mm
Hal - Fluo - Led | A+... C

14	Z5	AL PUR	PC MAT DIF	PC OPAL DIF		IP 23
	IP+ 15W					

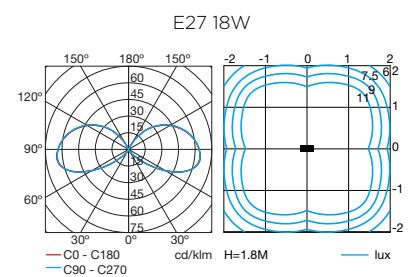

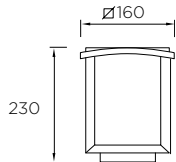

MARK

10-9298-Z5-M3 ■

E27 max. 100W | max. L 185mm
Hal - Fluo | A**... C

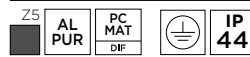

E27 18W

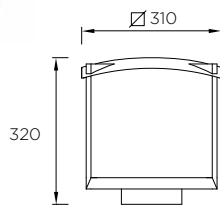
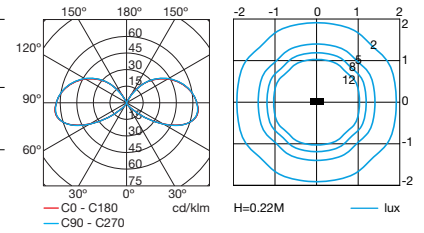

MARK

10-9390-Z5-M3 ■

E27 max. 100W | max. L 220mm
Hal - Fluo | A**... C

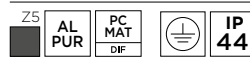

E27 30W

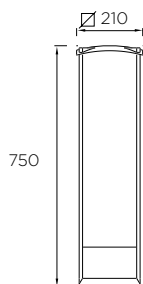
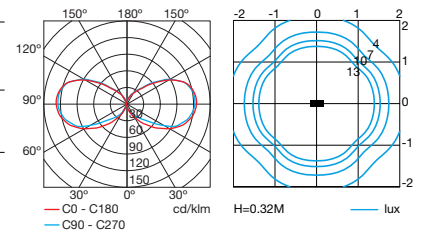

MARK

55-9390-14-M1 □ PC OPAL

55-9390-Z5-M3 ■ PC MAT

2G11 55W Fluo | A**... B

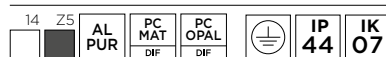

2G11 55W

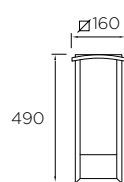
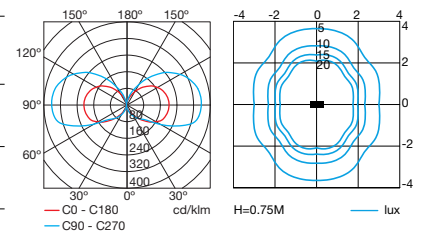

MARK

55-9298-Z5-M3 ■

2G11 24W Fluo | A**... B

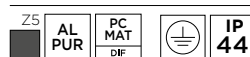

2G11 24W

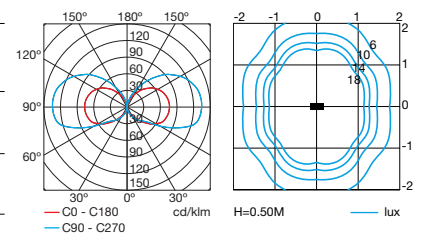



OUTDOOR | CLASSIC

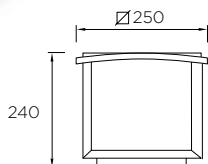

MARK

10-9299-14-M1

PC OPAL

10-9299-Z5-M3

PC MAT

E27 max. 100W | max. L 185mm
Hal - Fluo | A**... C

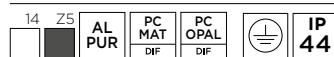

E27 23W

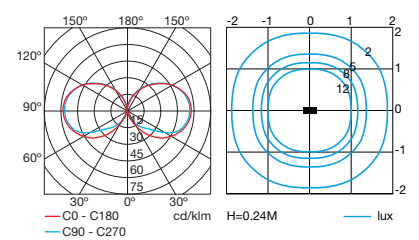

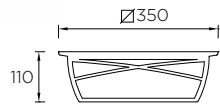

ALBA

15-9350-18-AA

2 x E27 max. 100W | max. L 200mm Ø 52mm
Hal - Fluo | A**... C

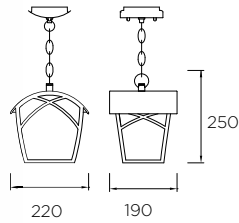
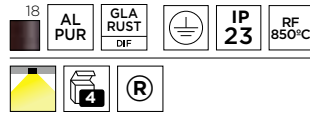

ALBA

00-9350-18-AA

E27 max. 100W | max. L 165mm
Hal - Fluo - Led | A**... C

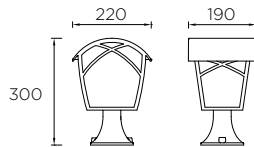
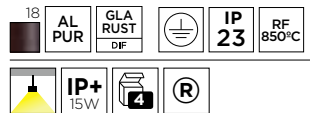

ALBA

10-9350-18-AA

E27 max. 100W | max. L 160mm
Hal - Fluo | A**... C

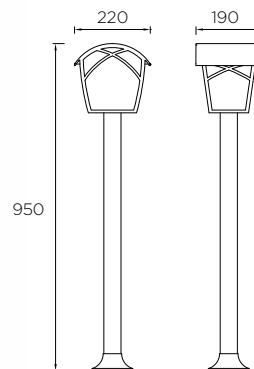
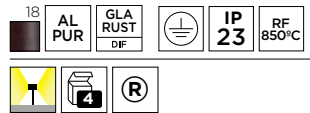

ALBA

55-9350-18-AA

E27 max. 100W | max. L 160mm
Hal - Fluo | A**... C

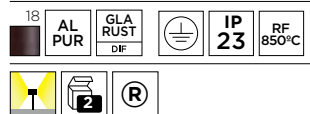

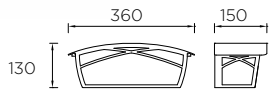

ALBA

05-9351-18-AA ■

E27 max. 100W | max. Ø 60mm
Hal - Fluo - Led | A**... C

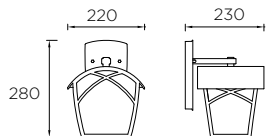

ALBA

05-9350-18-AA ■

E27 max. 100W | max. L 165mm
Hal - Fluo - Led | A**... C



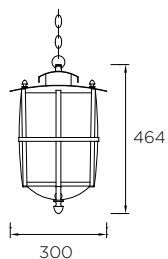

RUSTICA

00-9866-18-M3 ■

E27 max. 20W | max. L 165mm
Fluo | A**... C

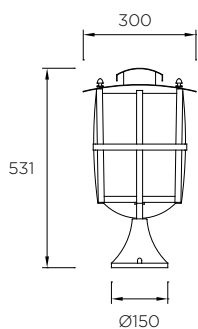
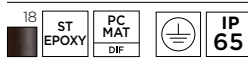

RUSTICA

10-9866-18-M3 ■

E27 max. 20W | max. L 165mm
Fluo | A**... C

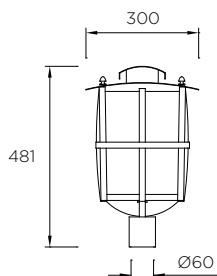
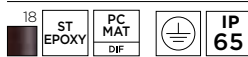

RUSTICA

60-9866-18-M3 ■

E27 max. 20W | max. L 165mm
Fluo | A**... C

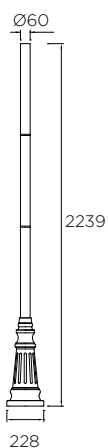
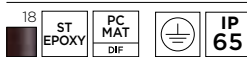

55-9866-18-18 ■

Columna / Column/ Mât / Säule / Colonna / Coluna /
Колонна / Stup



Para farola completa pedir códigos / For a complete
lamp post, order both codes. / Pour le réverbère complet,
demander les codes / Für komplette Laterne Art.-Nr. bes-
tellen / Per il lampione completo ordinare i codici / Para
poste de iluminação exterior completo pedir códigos /
Для заказа фонаря целиком запрашивайте следующие
артикулы / Dla pełnej latarni zamówić kody

60-9866-18-M3 + 55-9866-18-18



OUTDOOR | CLASSIC

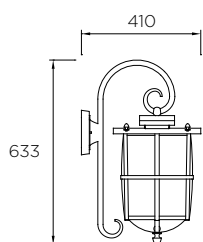

RUSTICA

05-9866-18-M3 ■

E27 max. 20W | max. L 165mm
Fluo | A**... C

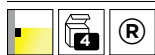
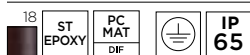

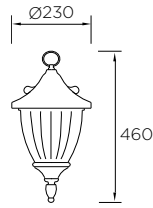

GALATEA

00-9151-18-E7

E27 max. 100W | max. L 167mm Ø 51mm
Hal - Fluo | **A++... C**

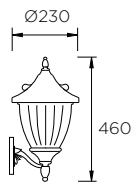
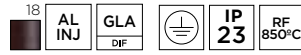

GALATEA

05-9151-18-E7

E27 max. 100W | max. L 167mm
Hal - Fluo | **A++... C**

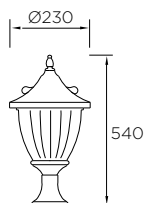

GALATEA

10-9151-18-E7

E27 max. 100W | max. L 167mm
Hal - Fluo | **A++... C**





GALATEA

60-9151-18-E7

3 x E14 max. 60W | max. L 120mm Ø35mm
Hal - Fluo | A**... C

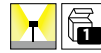

Ø300



2520

55-9151-18-18

Columna / Column/ Mât / Säule / Colonna / Coluna / Колонна / Słup



Para farola completa pedir códigos / For a complete lamp post, order both codes. / Pour le réverbère complet, demander les codes / Für eine komplette Mastleuchte bitte die folgenden Artikel - Nr. bestellen / Per il lampione completo ordinare i codici / Para poste de iluminação exterior completo pedir códigos / Для заказа фонаря целиком запрашивайте следующие артикулы / Dla pełnej latarni zamówić kody

60-9151-18-E7 + 55-9151-18-18



GALATEA

60-9152-18-E7

3 x E27 max. 100W | max. L 167mm Ø 51mm
Hal - Fluo | A**... C



Ø650

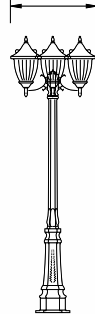

2380

55-9151-18-18

Columna / Column/ Mât / Säule / Colonna / Coluna / Колонна / Słup



Para farola completa pedir códigos / For a complete lamp post, order both codes. / Pour le réverbère complet, demander les codes / Für eine komplette Mastleuchte bitte die folgenden Artikel - Nr. bestellen / Per il lampione completo ordinare i codici / Para poste de iluminação exterior completo pedir códigos / Для заказа фонаря целиком запрашивайте следующие артикулы / Dla pełnej latarni zamówić kody

60-9152-18-E7 + 55-9151-18-18

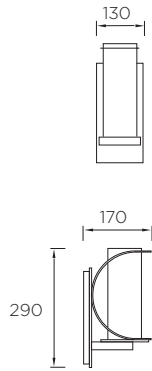

CIRI

05-9330-05-B8 ■

E27 max. 100W | max. L 155mm
Hal - Fluo | A**... C

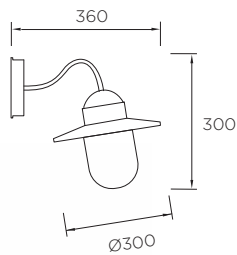
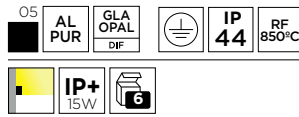

TRITON

05-8959-05-37 ■

E27 max. 100W | max. L 152 mm Ø 50mm
Hal - Fluo | A**... C

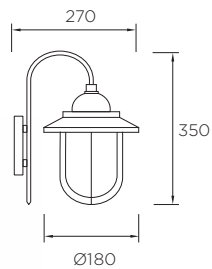
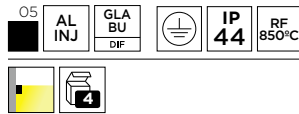

SIRENA

05-9104-18-M2 ■

E27 max. 60W | max. L 140mm Ø 51mm
Hal - Fluo | A**... C

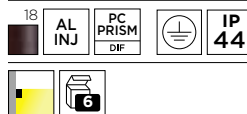



OUTDOOR | CLASSIC

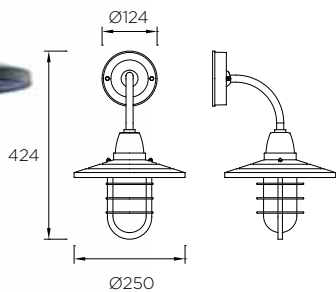

COTTAGE

05-9868-CC-B8 ■

E27 max. 20W | max. L 140mm Ø 56mm
Fluo | A**... C

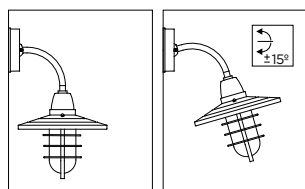

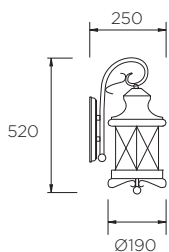

MORFEO

05-9175-18-AA

3 x E14 max. 60W | max. L 120mm Ø 35mm
Hal - Fluo - Led | A++... C

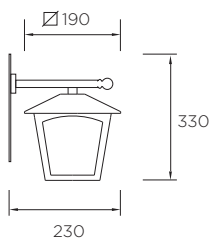

EDIPO

05-9149-18-AA

E27 max. 100W | max. L 140mm Ø 51mm
Hal - Fluo - Led | A++... C

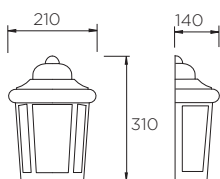

PERSEO

05-8762-18-37

E27 max. 100W | max. L 152mm Ø 50mm
Hal - Fluo - Led | A++... C



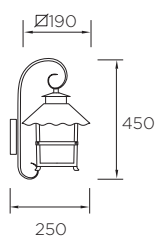

PERSEFONE

05-9202-18-AA ■

E27 max. 100W | max. L 167mm Ø 51mm
Hal - Fluo - Led | A**... C







LAMPS

LÁMPARAS

LAMPES

LEUCHTMITTEL

LAMPADINE

LÂMPADAS

ЛАМПЫ

ŻARÓWK

AR LED

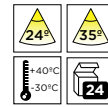
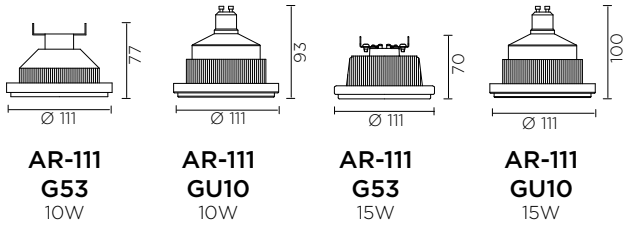

10W = **equivalente a as bright as 50w Halogen**

15W = **equivalente a as bright as 75w Halogen**



**AR-111
G53**



**AR-111
GU10**

LED SHARP



AR-111

		V	W	K		CRI	I (cd)	lm		T _c	
ACT-FLL-015	GU10	220-240	10	3000K	24°	>85	4200	532	>30000	61°	
ACT-FLL-017	GU10	220-240	10	3000K	35°	>85	2000	483	>30000	61°	



AR-111

		V	W	K		CRI	I (cd)	lm		T _c	
ACT-FLL-032	GU10	220-240	15	3000K	24°	>85	6000	802	>30000	72°	
ACT-FLL-033	GU10	220-240	15	3000K	35°	>85	3000	892	>30000	72°	



AR-111

		V	W	K		CRI	I (cd)	lm		T _c
ACT-FLL-011	G53	12	10	3000K	24°	>85	4200	532	>30000	61°
ACT-FLL-013	G53	12	10	3000K	35°	>85	2000	483	>30000	61°



AR-111

		V	W	K		CRI	I (cd)	lm		T _c
ACT-FLL-030	G53	12	15	3000K	24°	>85	6000	802	>30000	73°
ACT-FLL-031	G53	12	15	3000K	35°	>85	3000	892	>30000	73°

1 Driver = 1 G53



71-5489-00-00	100-240V				146 x 55 x 19mm
---------------	----------	--	--	--	-----------------

QPAR16 / MR16 LED

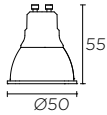

**QPAR16
GU10**

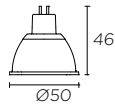

**MR16
GU5.3**

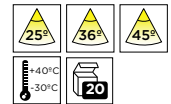

		W	K	V		CRI		T _c	
ACT-FLL-024	GU10	5	3.000	110-240	25°	>85	>30000	83°	-
ACT-FLL-025	GU10	5	3.000	110-240	45°	>85	>30000	83°	-
ACT-FLL-026	GU10	7	3.000	110-240	25°	>85	>30000	83°	-
ACT-FLL-027	GU10	7	3.000	110-240	36°	>85	>30000	83°	-
ACT-FLL-028	GU10	7	3.000	220-240	25°	>85	>30000	83°	
ACT-FLL-029	GU10	7	3.000	220-240	36°	>85	>30000	83°	



		W	K	V		CRI		T _c	
ACT-FLL-020V1	GU5.3	5	3.000	12	25°	>85	>30000	83°	-
ACT-FLL-021V1	GU5.3	5	3.000	12	45°	>85	>30000	83°	-
ACT-FLL-022	GU5.3	7	3.000	12	25°	>85	>30000	83°	-
ACT-FLL-023	GU5.3	7	3.000	12	36°	>85	>30000	83°	-

1 Driver = 1 GU5.3



ACT-TRA-002	230-240V			37 x 28 x 128 mm
-------------	----------	--	--	------------------



DATOS FOTOMÉTRICOS / PHOTOMETRIC DATA / DONNÉES PHOTOMÉTRIQUES / FOTOMETRISCHE DATEN / DATI FOTOMETRICI / DADOS FOTOMÉTRICOS / ФОТОМЕТРИЧЕСКИЕ ДАННЫЕ / DANE FOTOMETRYCZNE

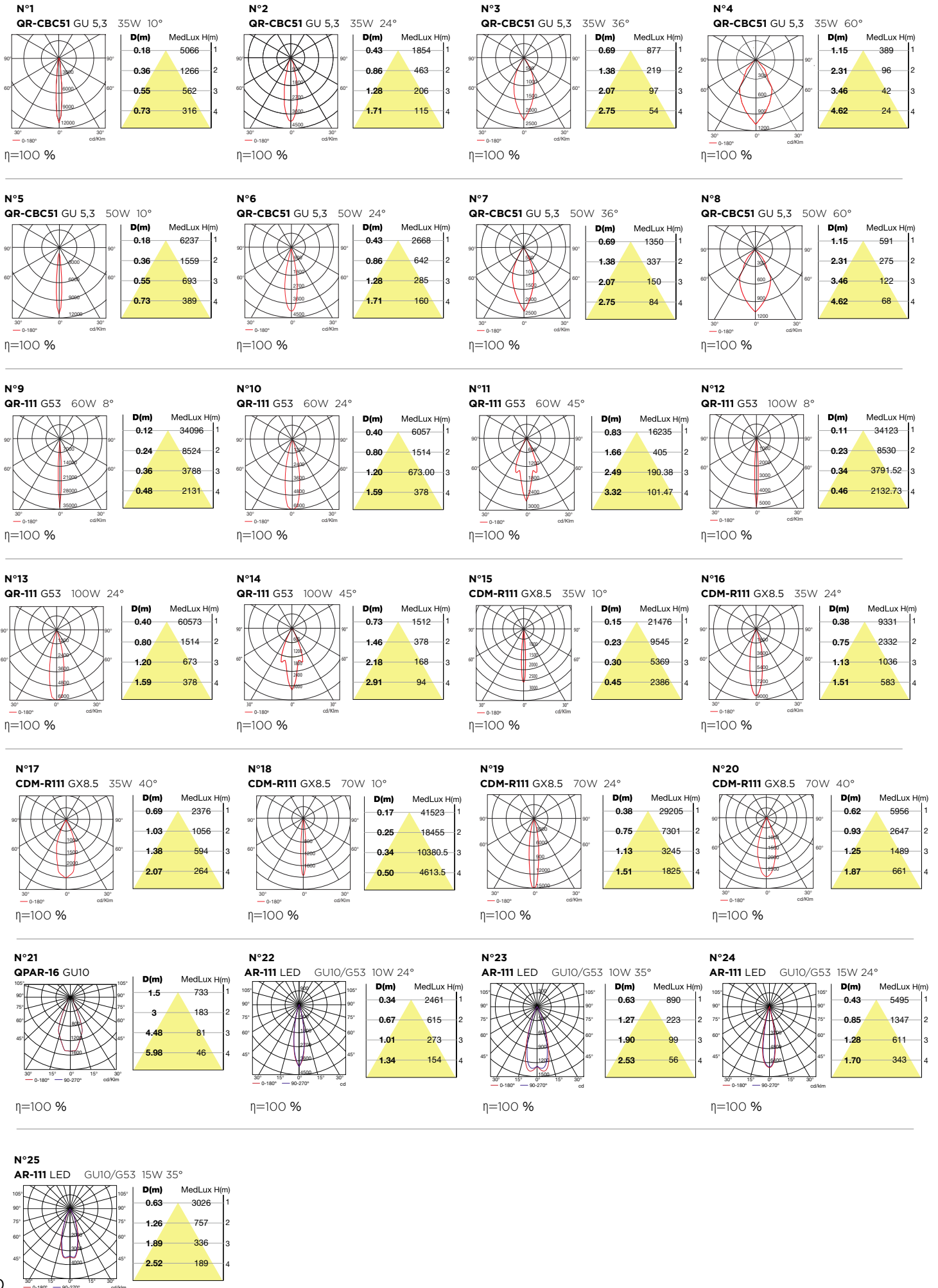

ELECTRICAL UNITS ACCESSORIES TECHNICAL INFORMATION

UNIDADES ELÉCTRICAS / ACCESORIOS /
INFORMACIÓN TÉCNICA

PLATINES ÉLECTRIQUES / ACCESSOIRES /
INFORMATIONS TECHNIQUES

NETZTEILE / ZUBEHÖRE / TECHNISCHE ANGABEN

UNITÁ ELETTRICHE / ACCESSORI /
INFORMAZIONI TECNICHE

UNIDADES ELÉTRICAS / ACESSÓRIOS /
INFORMAÇÃO TÉCNICA

ЭЛЕКТРООБОРУДОВАНИЕ / АКЦЕССУАРЫ /
ТЕХНИЧЕСКАЯ ИНФОРМАЦИЯ

CZĘŚCI ELEKTRYCZNE / AKCESORIA /
INFORMACJA TECHNICZNA

Tabla para la selección de driver.

Número máximo de piezas que pueden trabajar con cada equipo.

Entre paréntesis (x) valor para 100-127V. Todas las piezas se conectan en serie. Para un buen funcionamiento de la instalación, un técnico cualificado debe realizar el dimensionado de la instalación en referencia a la sección del cableado y distancias entre equipos y piezas.

Algunos drivers son multi-intensidad, por lo que debe seleccionarse la corriente adecuada según se indica en el etiquetaje de las piezas.

Driver selection table.

Maximum number of pieces that can work with each driver.

In brackets (x) value for 100-127V. All elements are connected in series. For the installation to work properly, a qualified technician must carry out the installation measurement with reference to the wiring section and the distances between equipment and pieces.

Some drivers are multicurrent, so that the right current must be chosen as shown in the labelling of the pieces.

Tableau de sélection du driver.

Nombre maximum de pièces pouvant fonctionner avec chaque appareil.

Entre parenthèses (x) valeur pour 100-127V. Toutes les pièces sont reliées en série. Pour un bon fonctionnement de l'installation, un technicien qualifié doit en assurer le dimensionnement en fonction de la section de câblage et des distances entre appareillages et pièces.

Certains drivers étant multi-intensité, il convient de sélectionner le courant adapté comme indiqué sur l'étiquette des pièces.

Tabelle für die Auswahl des Treibers.

Maximale Anzahl an Teile, die an ein Gerät angeschlossen werden können.

In Klammern (x) Wert für 100-127 V. Alle Teile werden in Reihe geschaltet. Für den einwandfreien Betrieb der Installation muss die Installation entsprechend dem Kabelquerschnitt und den Abständen der Aggregate und Teile untereinander von einem qualifizierten Elektriker ausgelegt werden.

Einige der Driver sind Geräte für verschiedene Stromstärken und die Stromstärke muss entsprechend der Kennzeichnung der Teile eingestellt werden.

ON/OFF																				
GEAR CODE	71-4807	71-5467	71-3922	71-5233	71-5234	71-5326	71-4813	71-4816	71-3923	71-5235	71-5327	71-4894	71-4896	71-4897	71-4890	71-5328	71-4891	71-4892	71-3542	
INPUT (V)	100-240	100-240	100-240	100-240	100-240	220-240	100-240	100-240	100-240	100-240	220-240	100-240	100-240	100-240	100-240	220-240	100-240	100-240	100-240	
IP	IP68	IP20	IP20	IP20	IP20	IP20	IP68	IP68	IP20	IP20	IP20	IP20	IP20	IP20	IP20	IP20	IP20	IP20	IP20	
PAGE	688	688	688	688	688	688	688	688	688	688	688	688	688	688	688	688	688	688	688	
CURRENT	350 mA			500 mA			700 mA						800 mA	900 mA	1000 mA	1050 mA	1200 mA	1400 mA	350-1050 mA	
																				
A*	min.2/ max.3	max.3	min.2/ max.6	min.5/ max.12															max.20	
B*	min.2/ max.3	min.2/ max.3	min.2/ max.6	min.5/ max.12	min.4/ max.9		max.1	min.2/ max.3	max.3	min.3/ max.6									max.18 (14)	
C											max.1	max.1	max.1	max.1	max.1	max.1	max.1	max.1	max.1	
D	max.1	max.1	max.2	min.2/ max.4	min.2/ max.3			max.1	max.1	max.2									max.6 (4)	
E*	max.1	max.1	min.1/ max.2	min.2/ max.4	min.2/ max.3			max.1	max.1	max.2	min.4/ max.4	min.3/ max.4							max.6 (5)	
F			max.1	min.2/ max.3	min.2/ max.2					max.1									max.4(3)	
G																			max.1	
H*	max.1	max.1	max.2	min.2/ max.4															max.7	
I*				max.1															max.1	
J			max.1							max.1	min.3/ max.3	min.3/ max.3							max.5(4)	
K				max.1	max.1														max.2	
L				max.1		max.1					max.1	max.1							max.1	
M				max.1		max.1					max.1	max.1							max.1	
N											max.1	max.1	max.1	max.1	max.1	max.1			max.1 (0)	
O											max.1	max.1	max.1						max.1	
P											max.1	max.1	max.1	max.1					max.1	
Q											max.1	max.1	max.1	max.1	max.1	max.1	max.1		max.1	
S											max.1	max.1	max.1	max.1	max.1				max.1	

* Comprobar medida equipo
Check measurement driver
Vérifier les dimensions de l'appareillage
Messung Aggregat prüfen

Comprovare la misura del dispositivo
Verificar medida do equipamento
Уточнить размер драйвера
Sprawdzić wielkość osprzętu

Tabella per la selezione del driver.

Numero massimo di pezzi che possono funzionare con ciascun dispositivo.

Tra parentesi (x) valore per 100-127V. Tutti i pezzi si collegano in successione. Per un buon funzionamento dell'impianto, un tecnico qualificato deve progettare il dimensionamento dell'impianto in riferimento alla sezione del cablaggio e delle distanze tra dispositivi e pezzi.

Alcuni driver sono multi-intensità, pertanto si deve selezionare la corrente adeguata come indicato sull'etichetta dei pezzi.

Tabela para a seleção de driver.

Número máximo de peças que podem funcionar com cada driver.

Entre parenteses (x) valor para 100-127V. Todas as peças devem ser ligadas em série. Para um bom funcionamento da instalação um técnico qualificado deve avaliar e dimensionar corretamente a seção do cabo e as distâncias entre aparelhos e drivers.

Alguns drivers, são multi-intensidade, por isso deve ser escolhida a corrente adequada em função da informação que consta da etiqueta dos aparelhos.

Таблица для выбора драйвера.

Максимальное количество единиц, которые могут работать с каждым устройством.

В скобках (x) величина для 100-127В. Все части соединены последовательно. Для обеспечения оптимальной работы оборудования, квалифицированный специалист должен произвести замеры, установить сечение проводов и расстояние между устройствами и элементами. Некоторые драйверы рассчитаны на разные показатели напряжения, поэтому необходимо выбирать электросеть, согласно указаниям на этикетках элементов.

Tablica dla wybrania sterownika.

Maksymalna ilość elementów jakie mogą pracować z każdym osprzętem.



W nawiasie (x) wartość dla 100-127V. Wszystkie elementy podłączane są szeregowo. Dla właściwego działania instalacji wykwalifikowany technik powinien wykonać pomiar instalacji pod względem przekroju kabli i odległości pomiędzy urządzeniami i elementami.

Niektóre sterowniki są o kilku natężeniach, dlatego należy wybrać odpowiedni prąd w zależności od tego, co wskazane jest na etykietce elementów.

DIMMABLE								
	1-10V PUSH	DALI 1-10V PUSH	1-10V PUSH	DALI 1-10V PUSH	CORTE DE FASE / MAINS DIMMING / PHASE CUT			
	71-3475	71-4706	71-4708	71-2413	71-5272	71-4899	71-4928	GEAR CODE
	100-240	100-240	100-240	100-240	220-240	220-240	220-240	INPUT (V)
	IP20	IP20	IP20	IP20	IP20	IP20	IP20	IP
	689	689	689	689	689	689	689	PAGE
	350- 700mA	350-1050mA		1050- 2100mA	350mA	700mA		CURRENT 
	max.12	max.20	max.20		min.6/ max.10			A*
	max.9(5)	max.18(14)	max.18(14)			min.3/ max.3		B*
		max.1	max.1	max.1(0)			max.1	C
	max.3 (1)	max.6 (4)	max.6 (4)		max.1	min.3/ max.4	max.4	D
	max.3(2)	max.6(5)	max.6(5)			max.1	min.3/ max.4	E*
	max.2(1)	max.4(3)	max.4(3)				min.2/ max.3	F
		max.1	max.1				max.1	G
	max.4	max.7	max.7		min.2/ max.3			H*
	max.1	max.1	max.1		max.1			I*
	max.2(1)	max.5(4)	max.5(4)			max.1	min.2/ max.3	J
	max.1(0)	max.2	max.2		max.1		max.1	K
		max.1	max.1				max.1	L
	max.1	max.1	max.1				max.1	M
		max.1(0)	max.1(0)	max.1(0)				N
		max.1	max.1				max.1	O
		max.1	max.1				max.1	P
				max.1(0)				Q
		max.1	max.1					S



Tabla para la selección de fuentes de alimentación y/o controladores
Power supply and controller selection table
Tableau de sélection des sources d'alimentation et des contrôleurs
Tabelle zur Auswahl der Netzgeräte und Controller
Tabella per la selezione delle fonti di alimentazione e controller
Tabela para a selecção de fonte de alimentação e controladores
Таблица для выбора источников питания и контроллеров
Tabela doboru zasilaczy i kontrolerów



POWER SUPPLY										
CODE	71-3479-00-00	71-0038-00-00	71-0039-00-00	71-0063-00-00	71-5487-00-00	71-0064-00-00	71-4038-00-00	71-0065-00-00	71-0066-00-00	
										
VOLTAGE	12	24	24	24	24	24	24	24	24	
WATTAGE	100	26,4	52,8	76,8	96	156	150	240	312	
IP	IP67	IP20	IP20	IP20	IP20	IP20	IP67	20	20	
PAGE	690	690	690	690	690	690	690	690	690	

PRODUCT CODE	SERIE	VERSION	V	W	L(M)	W/M	MIN CUT (MM)	MAX METERS IN SERIE	MAX METER VS POWER SUPPLY								
91-2492-00-00	ZENIT	White	24	24	5	9,6	100	10		2,7mts	5,5mts	8mts	10mts	16mts	15mts	25mts	32mts
91-4671-00-00	ON	WW	24	24	5	4,8	100	20		5,5mts	11mts	16mts	20mts	32mts	31mts	50mts	65mts
91-0150-00-00	ON ECO	WW	24	24	5	4,8	100	20		5,5mts	11mts	16mts	20mts	32mts	31mts	50mts	65mts
91-2361-00-00	ON HP	WW	24	48	5	9,6	76	10		2,7mts	5,5mts	8mts	10mts	16mts	15mts	25mts	32mts
91-3282-00-00	ON HP	2500K	24	48	5	9,6	76	10		2,7mts	5,5mts	8mts	10mts	16mts	15mts	25mts	32mts
91-2365-00-00	ON HP	CW	24	72	5	9,6	76	10		2,7mts	5,5mts	8mts	10mts	16mts	15mts	25mts	32mts
91-2379-00-00	ON HP	RGB	24	36	5	14,4	100	5		1,8mts	3,6mts	5,3mts	6,6mts	10mts	10mts	16mts	21mts
91-0175-00-00	ON IP ECO	WW	24	48	5	4,8	100	20		5,5mts	11mts	16mts	20mts	32mts	31mts	50mts	65mts
91-0171-00-00	ON IP ECO	CW	24	54	5	4,8	100	20		5,5mts	11mts	16mts	20mts	32mts	31mts	50mts	65mts
91-2491-00-00	ON IP ECO	RGB	24	54	5	7,2	166	10		3,6mts	7,3mts	10mts	13,3mts	21mts	20mts	33mts	43mts
91-4763-00-00	ON HP IP	WW	24	48	5	9,6	76	10		2,7mts	5,5mts	8mts	10mts	16mts	15mts	25mts	32mts
91-4764-00-00	ON SP	WW	24	24	5	28	50	5		0,9mts	1,8mts	2,7mts	3,4mts	5,5mts	5,3mts	8,5mts	11mts
91-4765-00-00	ON SP IP	WW	24	48	5	28	50	5		0,9mts	1,8mts	2,7mts	3,4mts	5,5mts	5,3mts	8,5mts	11mts
91-5452-00-00	DEEP	WW	24	144	10	14	100	10		1,8mts	3,6mts	5,3mts	6,6mts	10mts	10mts	16mts	21mts
91-5453-00-00	DEEP	RGB	24	144	10	14,4	100	10		1,8mts	3,6mts	5,3mts	6,6mts	10mts	10mts	16mts	21mts

	CONTROLLERS						
	WHITE				RGB		
	71-0017-00-00	71-0727-00-00	71-3473-00-00	71-1553-00-00	71-0019-00-00	71-1553-00-00	71-1553-00-00
	CONTROLLER WITH REMOTE CONTROL	1-10V CONTROLLER	DALI CONTROLLER	AMPLIFIER	CONTROLLER WITH REMOTE CONTROL	AMPLIFIER	AMPLIFIER
	12(144W)	12(156W)	12(60W)	12(48W)	12(216W)	12(144W)	12(48W)
	24(288W)	24(312W)	24(120W)	24(96W)	24(432W)	24(288W)	24(96W)
	IP20	IP20	IP20	IP20	IP20	IP20	IP20
	697	697	697	697	696	697	697
MAX METER VS CONTROLLER							
	60mts	65mts	25mts	20mts			20mts
	60mts	65mts	25mts	20mts			20mts
	30mts	32mts	12mts	10mts			10mts
	30mts	32mts	12mts	10mts			10mts
	30mts	32mts	12mts	10mts			10mts
					30mts	20mts	
	60mts	65mts	25mts	20mts			20mts
	60mts	65mts	25mts	20mts			20mts
					60mts	40mts	
	30mts	32mts	12mts	10mts			10mts
	10mts	11mts	4,2mts	3,4mts			3,4mts
	10mts	11mts	4,2mts	3,4mts			3,4mts
	20mts	21mts	8,3mts	6,6mts			6,6mts
					30mts	20mts	



Tabla para la selección de fuentes de alimentación y/o controladores
Power supply and controller selection table
Tableau de sélection des sources d'alimentation et des contrôleurs
Tabelle zur Auswahl der Netzgeräte und Controller
Tabella per la selezione delle fonti di alimentazione e controller
Tabela para a selecção de fonte de alimentação e controladores
Таблица для выбора источников питания и контроллеров
Tabela doboru zasilaczy i kontrolerów

POWER SUPPLY										
CODE	71-3479-00-00	71-0038-00-00	71-0039-00-00	71-0063-00-00	71-5487-00-00	71-0064-00-00	71-4038-00-00	71-0065-00-00	71-0066-00-00	
										
VOLTAGE	12	24	24	24	24	24	24	24	24	
WATTAGE	100	26,4	52,8	76,8	96	156	150	240	312	
IP	IP67	IP20	IP20	IP20	IP20	IP20	IP67	20	20	
PAGE	690	690	690	690	690	690	690	690	690	

PRODUCT CODE	SERIE	VERSION	V	W	L(M)	W/M	MAX PCS IN SERIE	MAX PCS VS POWER SUPPLY								
05-1547-54-H6	TRON	WW	24	24	0,5		4		max1	max2	max3	max4	max6	max6	max10	max13
05-1546-54-H6	TRON	NW	24	24	0,5		4		max1	max2	max3	max4	max6	max6	max10	max13
05-1544-54-H6	TRON	RGB	24	30	0,5		4		max1	max2	max3	max5	max3	max8	max10	
05-1552-54-H6	TRON	WW	24	48	1		2		max1	max1	max2	max3	max3	max5	max6	
05-1549-54-H6	TRON	NW	24	48	1		2		max1	max1	max2	max3	max3	max5	max6	
05-1548-54-H6	TRON	RGB	24	60	1		2		max1	max1	max2	max2	max4	max5		
05-2499-54-H6	RAY	WW	24	48	0,378		2		max1	max1	max2	max3	max3	max5	max6	
05-2494-54-H6	RAY	NW	24	48	0,378		2		max1	max1	max2	max3	max3	max5	max6	
05-2498-54-H6	RAY	RGB	24	60	0,378		2		max1	max1	max2	max2	max4	max5		
91-3411-54-M2	ION	WW	12	7,2	0,5	7,2	6	max13								
91-3408-54-M2	ION	WW	12	14,4	1	14,4	3	max6								

	CONTROLLERS						
	WHITE				RGB		
	71-0017-00-00	71-0727-00-00	71-3473-00-00	71-1553-00-00	71-0019-00-00	71-1553-00-00	71-1553-00-00
	CONTROLLER WITH REMOTE CONTROL	1-10V CONTROLLER	DALI CONTROLLER	AMPLIFIER	CONTROLLER WITH REMOTE CONTROL	AMPLIFIER	AMPLIFIER
	12(144W)	12(156W)	12(60W)	12(48W)	12(216W)	12(144W)	12(48W)
	24(288W)	24(312W)	24(120W)	24(96W)	24(432W)	24(288W)	24(96W)
	IP20	IP20	IP20	IP20	IP20	IP20	IP20
	697	697	697	697	696	697	697
	MAX METER VS CONTROLLER						
	max12	max13	max5	max4			max4
	max12	max13	max5	max4			max4
					max14	max9	
	max6	max6	max2	max2			max2
	max6	max6	max2	max2			max2
					max7	max4	
	max6	max6	max2	max2			max2
	max6	max6	max2	max2			max2
					max7	max4	
	max12	max12	max8	max6			max6
	max6	max6	max4	max3			max3



ON-OFF / ВКЛ/ВЫКЛ / WŁĄCZ/WYŁĄCZ



	71-5467-00-00	IP 20		33 x 17 x 57 mm
	71-3922-00-00	IP 20		39 x 19 x 79 mm
	71-4807-00-00	IP 68		44 x 26 x 79 mm
	71-5233-00-00	IP 20		38 x 18 x 122 mm
	71-5234-00-00	IP 20		39 x 18 x 122 mm
	71-5326-00-00	IP 20		45 x 29 x 115 mm
	71-3923-00-00	IP 20		39 x 19 x 79 mm
	71-5235-00-00	IP 20		38 x 18 x 122 mm
	71-5327-00-00	IP 20		68 x 32 x 105 mm
	71-4813-00-00	IP 68		44 x 26 x 79 mm
	71-4816-00-00	IP 68		44 x 26 x 79 mm
	71-4894-00-00	IP 20		45 x 28 x 104 mm
	71-4896-00-00	IP 20		54 x 36 x 157 mm
	71-4897-00-00	IP 20		54 x 36 x 157 mm
	71-4890-00-00	IP 20		75 x 32 x 129 mm
	71-5328-00-00	IP 20		68 x 32 x 105 mm
	71-4891-00-00	IP 20		75 x 32 x 129 mm
	71-4892-00-00	IP 20		75 x 32 x 129 mm
	71-3542-00-00	IP 20		79 x 22 x 125 mm

DRIVER / LED-BETRIEBSGERÄT / STEROWNIK / ДРАЙВЕР

REGULABLE / DIMMABLE / RÉGULABLE / DIMMBAR / REGOLABILE / REGULÁVEL / РЕГУЛИРУЕМЫЙ / ŚCIEMNIANY



	71-5272-00-00		CORTE DE FASE / MAINS DIMMING / PHASE CUT	53 x 25 x 95 mm
	71-4899-00-00		CORTE DE FASE / MAINS DIMMING / PHASE CUT	53 x 25 x 95 mm
	71-4928-00-00		CORTE DE FASE / MAINS DIMMING / PHASE CUT	54 x 36 x 157 mm
	71-3475-00-00			67 x 21 x 103 mm
	71-4708-00-00			79 x 22 x 125 mm
	71-4706-00-00			79 x 22 x 125 mm
	71-2413-00-00			83 x 35 x 163 mm

CABLE PARA SINCRONIZACIÓN, SERVIDO SEPARADAMENTE
 CABLE FOR SYNCHRONISING SLAVE REGULATORS
 CÂBLE DE SYNCHRONISATION FOURNI SÉPARÉMENT
 KABEL FÜR DIE SYNCHRONISIERUNG VON SLAVE-REGLERN
 CAVO PER SINCRONIZZAZIONE, FORNITO SEPARATAMENTE
 CABO PARA SINCRONIZAÇÃO, FORNECIDO EM SEPARADO
 СИНХРОНИЗИРУЮЩИЙ КАБЕЛЬ, ПОСТАВЛЯЕТСЯ ОТДЕЛЬНО
 PRZEWÓD DLA SYNCHRONIZOWANIA, DOSTARCZANY ODDZIELNIE

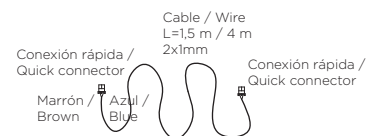

71-3476-00-00	1,5m cable
71-4707-00-00	4m cable



**12
VDC****Fuentes de alimentación / Power supply / Sources d'alimentation / Netzgeräte / Fonti di alimentazione / Fontes de alimentação/ Источники питания / Zasilacze**

71-3479-00-00	110-264VAC	47-63 Hz	8,3 A	100 W		IP 67	-	34 x 60 x 240 mm
---------------	------------	----------	----------	----------	--	----------	---	------------------

**24
VDC****Fuentes de alimentación / Power supply / Sources d'alimentation / Netzgeräte / Fonti di alimentazione / Fontes de alimentação/ Источники питания / Zasilacze**

71-5487-00-00	100-240V	47-63 Hz	4A	96 W		IP 20	-	21 x 40 x 300 mm
---------------	----------	----------	----	---------	--	----------	---	------------------



71-0038-00-00	100-240VAC	47-63 Hz	1,1 A	26,4 W				28 x 51 x 92 mm
71-0039-00-00	100-240VAC	47-63 Hz	2,2 A	52,8 W		IP 20	-	36 x 97 x 99 mm
71-0063-00-00	100-240VAC	47-63 Hz	3,2 A	76,8 W				38 x 98 x 129 mm
71-0064-00-00	100-120VAC; 200-240VAC	47-63 Hz	6,5 A	156 W				38 x 98 x 199 mm



71-0065-00-00	100-240VAC	47-63 Hz	10 A	240 W		IP 20		50 x 93 x 204 mm
71-0066-00-00	100-240VAC	47-63 Hz	13 A	312 W				50 x 115 x 229 mm



71-4038-00-00	90-295VAC	50-60 Hz	6,3 A	150 W		IP 67		38,8 x 68 x 222 mm
---------------	-----------	----------	----------	----------	--	----------	--	--------------------

12
VAC

Transformador / Transformer / Transformateur / Transformator / Trasformatore / Transformador / трансформатор / Transformator



ACT-TRA-001	230V-240V	50-60 Hz	20-60W	IP 20	37 x 28 x 128 mm
ACT-TRA-002	230V-240V	50-60 Hz	20-70W	⊕	37 x 28 x 128 mm
71-2477-00-00	230V-240V	50-60 Hz	20-105W	DIMMING	35 x 21 x 107 mm

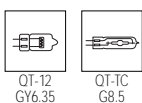
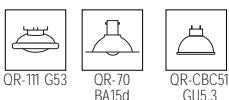

71-9197-05-05	230V	50 Hz	0- 100W	IP 68	1m	⊕	⊕	149 x 115 x 115 mm
---------------	------	-------	---------	-------	----	---	---	--------------------

Equipo para lámparas de descarga / Equipment for discharge lamps / Appareillages pour lampes à décharge / Vorschaltgeräte für Gasentladungslampen / Apparecchiature per lampade a scarica / Equipamentos para lâmpadas de descarga / Наборы для газоразрядных ламп / Osprzet dla lamp wyładowczych

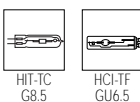
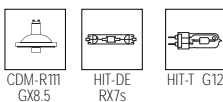

ACT-BAL-003	35W	67 x 31 x 140 mm
ACT-BAL-004	2x35W	89 x 37 x 224 mm
ACT-BAL-005	70W	83 x 32 x 170 mm
ACT-BAL-006	2x70W	89 x 37 x 224 mm



CONTROLADORES DMX / DMX CONTROLLERS / CONTRÔLEURS DMX / DMX-CONTROLLER / REGOLATORI DMX / CONTROLADORES DMX / КОНТРОЛЛЕРЫ DMX / STEROWNIK DMX

- Para configuraciones a medida, consulte con nuestro equipo comercial
- For bespoke combinations please contact our sales department
- Pour des configurations sur mesure, merci de consulter notre équipe commerciale
- Für Konfigurationen nach Maß, sprechen Sie uns bitte an
- Per configurazioni su misura rivolgersi al ns. ufficio commerciale

- Para configurações à medida, consulte a n/ equipa comercial
- Для модификаций по индивидуальным параметрам свяжитесь с нашими коммерческими сотрудниками
- Dla wspomnianych zestawień prosimy o kontakt z naszym działem sprzedaży

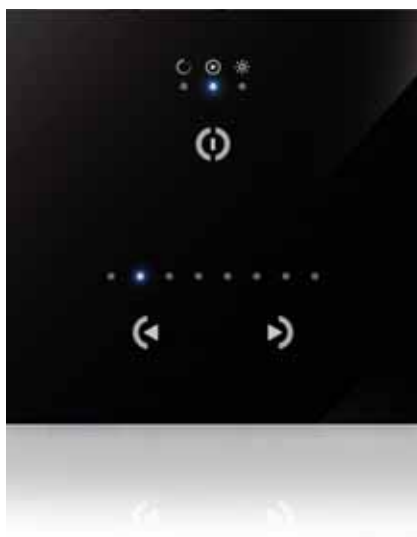

- Controladores DMX512 que no requieren de sistema operativo para ejecutarse.
- Ajuste en tiempo real de la intensidad y el color de una escena.
- Programable mediante el software de control y el cable USB incluidos.
- Fuente de alimentación incluida.

- DMX512 stand alone controller.
- Live setting of the intensity and colour of a scene.
- Programmable with the included USB cable and control software.
- Power supply included.

- Contrôleurs DMX512 dont l'exécution n'exige pas de système d'exploitation.
- Réglage en temps réel de l'intensité et de la couleur d'une scène.
- Programmable à l'aide du logiciel de commande et du câble USB fournis.
- Source d'alimentation fournie.

- DMX512-Controller, die kein Betriebssystem erfordern.
- Einstellung der Lichtstärke und Farbe in Echtzeit.
- Programmierbar mittels Steuersoftware, USB-Kabel mitgeliefert.
- Netzteil mitgeliefert.

- Regolatori DMX512 che non necessitano di sistema operativo per funzionare.
- Regolazione in tempo reale dell'intensità e del colore di una scena.
- Programmabile tramite il software di controllo e il cavo USB inclusi.
- Fonte di alimentazione inclusa.

- Controladores DMX512 que não necessitam de sistema operativo para funcionar.
- Ajuste em tempo real da intensidade e da cor de uma cena.
- Programável através do software de controlo e do cabo USB incluídos.
- Fonte de alimentação incluída.

- Контроллеры DMX512, не требующие для работы оперативной системы.
- Регулировка в реальном времени интенсивности и цвета сцены.
- Программируемые с помощью входящих в комплект контрольной программы и кабеля USB.
- В комплект входит источник питания.

- Sterownik DMX512, który nie wymaga systemu operacyjnego dla jego obsługi.
- Ustawienie w czasie rzeczywistym natężenia i koloru sceny.
- Programowany za pomocą załączonego oprogramowania sterującego i przewodu USB.
- Zawarte źródło zasilania.



- Controlador DMX de instalación en pared, que no requiere de sistema operativo para ejecutarse.
- Panel táctil con 25 páginas de 8 escenas.
- Cable USB, CDROM para instalación y manual de usuario incluidos.
- Fuente de alimentación y control remoto Infrarrojo incluidos.

- Stand alone wall mounted DMX controller.
- Touch-sensitive panel with 25 pages of 8 scenes.
- Delivered with a USB cable and installation CDROM including user manual.
- Power supply and Infra red remote control included.

- Contrôleur DMX à installation murale, dont l'exécution n'exige pas de système d'exploitation.
- Tableau tactile avec 25 pages de 8 scènes.
- Câble USB, CD-ROM d'installation et manuel de l'utilisateur fournis.
- Source d'alimentation et télécommande Infrarouge fournies.

- DMX-Controller zum Wandeinbau, kein Betriebssystem erforderlich.
- Touchscreen mit 25 Seiten à 8 Szenen.
- USB-Kabel, CDROM zur Installation und Bedienungsanleitung mitgeliefert.
- Netzteil und Infrarot-Fernbedienung mitgeliefert.

- Regolatore DMX da installare parete, che non necessita di un sistema operativo per funzionare.
- Pannello tattile con 25 pagine di 8 scene.
- Cavo USB, CDROM per l'installazione e manuale per l'utente inclusi.
- Fonte di alimentazione e controllo remoto Infrarossi inclusi.

- Controlador DMX de instalação em parede, que não necessita de sistema operativo para funcionar.
- Painel tátil com 25 páginas de 8 cenas.
- Cabo USB, CD-ROM para instalação e manual de utilizador incluídos.
- Fonte de alimentação e controlo remoto por infravermelhos incluídos.

- Настенный контроллер DMX, не требующий оперативной системы.
- Сенсорная панель с 25 страницами из 8 сцен.
- В комплект включены USB-кабель, CD-ROM для установки и руководство пользователя.
- Источник питания и инфракрасный дистанционный пульт управления включены в комплект.

- Sterownik DMX instalacji na ścianie, który nie wymaga systemu operacyjnego dla jego obsługi.
- Panel dotykowy o 25 stronach 8 scen.
- Zawarte: przewód USB, CDROM dla zainstalowania i instrukcja użytkownika.
- Zawarte źródło zasilania i zdalne sterowanie na podczerwień.

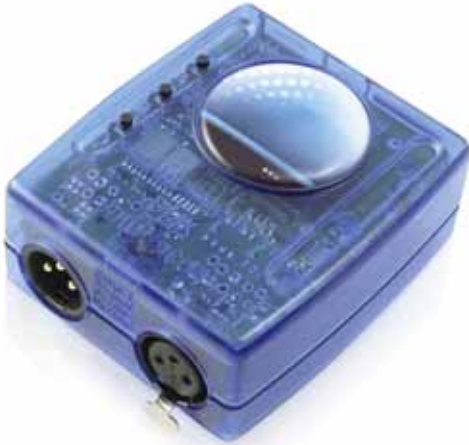

- Interfaz Mini USB-DMX interface.
- Memoria de 64K con reloj/calendario.
- Cable USB, CDROM para instalación y manual de usuario incluidos.
- Fuente de alimentación incluida.

- Mini USB-DMX interface.
- 64K memory with clock/calendar.
- Delivered with a USB cable and installation CDROM including user manual.
- Power supply included.

- Interface Mini USB-DMX.
- Mémoire de 64 K avec horloge/calendrier.
- Câble USB, CD-ROM d'installation et manuel de l'utilisateur fournis.
- Source d'alimentation fournie.

- Schnittstelle Mini USB-DMX.
- 64-K-Speicher mit Uhr/Kalender.
- USB-Kabel, CDROM zur Installation und Bedienungsanleitung mitgeliefert.
- Netzteil mitgeliefert.

- Interfaccia Mini USB-DMX.
- Memoria di 64K con orologio/calendario.
- Cavo USB, CDROM per l'installazione e manuale per l'utente inclusi.
- Fonte di alimentazione inclusa.

- Interface Mini USB-DMX.
- Memória de 64 K com relógio/calendário.
- Cabo USB, CD-ROM para instalação e manual de utilizador incluídos.
- Fonte de alimentação incluída.

- Интерфейс мини USB-DMX.
- Память 64K с часами/календарем.
- В комплект включены USB-кабель, CD-ROM для установки и руководство пользователя.
- В комплект входит источник питания.

- Interfejs Mini USB-DMX.
- Pamięć 64K z zegarem/kalendarzem.
- Zawarte: przewód USB, CDROM dla zainstalowania i instrukcja użytkownika.
- Zawarte źródło zasilania.



TELECOMMUNICATIONS CULTURAL CENTER, SANTO DOMINGO. REP. DOMINICANA.



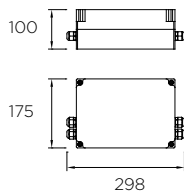

MASTER RGBEASY+

71-9816-00-00

150W

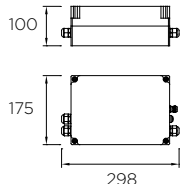

SLAVE RGBEASY+

71-9817-00-00

150W

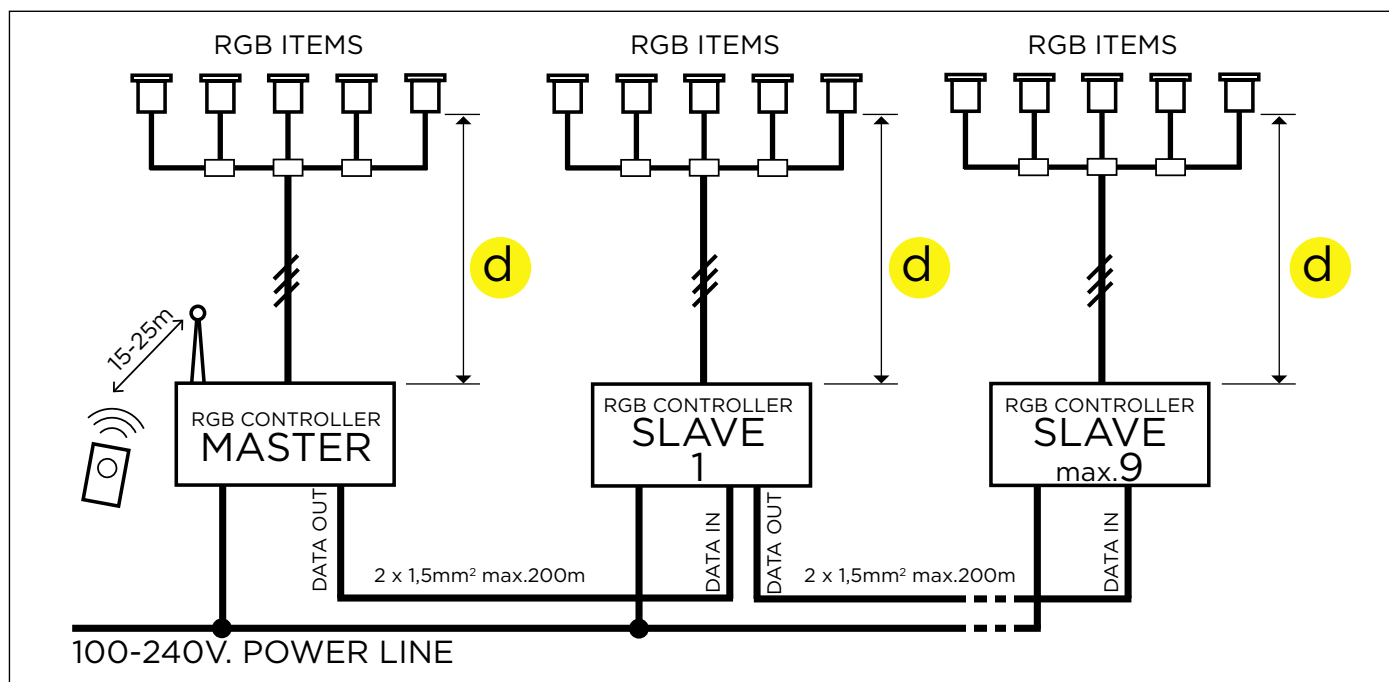

		3 x 1,5 mm ²	3 x 2,5 mm ²
d	25m	max. 120W	max. 135W
	50m	max. 110W	max. 120W
	100m	max. 90W	max. 100W

Potencia máxima que puede alimentar cada equipo Master y/o Esclavo teniendo en cuenta la sección de cable utilizada en la instalación y la distancia máxima (d) entre cada equipo y la última luminaria.

Maximum power to supply every Master and/or Slave equipment according to the wiring section used in the installation and the maximum distance (d) between every equipment and the last piece.

Puissance maximale que chaque appareillage maître et/ou esclave peut alimenter compte tenu de la section de câble utilisée dans l'installation et de la distance maximale (d) entre chaque appareil et la dernière pièce.

Maximale Leistung für Master- und/oder Slave-Aggregat unter Berücksichtigung des Kabelquerschnitts der Installation und des maximalen Abstands (d) zwischen dem jeweiligen Aggregat und dem letzten Teil.

Potenza massima che può alimentare ogni dispositivo Master e / o Slave tenendo in conto la sezione di cavo utilizzata nell'impianto e la distanza massima (d) tra ogni dispositivo e l'ultimo pezzo.

Potência máxima que pode alimentar cada equipamento Master e/ou Slave, tendo em conta a secção de cabo utilizada na instalação e a distância máxima (d) entre cada equipamento e a última peça.

Максимальная мощность, которая может подаваться на каждое ведущее и/или ведомое устройство, принимая во внимание сечение провода, используемое при монтаже, и максимальное расстояние (d) между каждым устройством и последним элементом.

Maksymalna moc jaka może zasilać każde urządzenie Master i/lub Esclavo biorąc pod uwagę przekrój kabla zastosowanego w instalacji i maksymalną odległość (d) pomiędzy każdym urządzeniem i ostatnim elementem.

¿POR QUÉ LO LLAMAMOS **RGBEASY+** ?
 WHY DO WE CALL IT **RGBEASY+**?
 POURQUOI L'APPELLATION **RGBEASY+**?
 WARUM HEISST ES **RGBEASY+**?



- Toda la instalación se hace mediante cables estándar de 3 polos.
- The entire installation is carried out using standard 3-core cables.
- Toute l'installation s'effectue à l'aide de câbles standard à 3 pôles.
- Die Installation erfolgt mittels 3-poligen Standardkabeln.
- L'intera installazione viene eseguita tramite cavi standard di 3 poli.
- Toda a instalação se faz através de cabos standard de 3 pólos.
- Вся установка осуществляется с помощью стандартного 3-х фазного кабеля.
- Całą instalację wykonuje się za pomocą standardowych przewodów 3 biegunowych.



- Podemos usar el pulsador situado en el lateral de la caja del controlador para cambiar el programa en caso de pérdida o falta de batería del mando a distancia.
- We can use the push-button located on the side of the controller box to change the programme in the event of loss or lack of battery power in the remote control.
- On peut utiliser le bouton situé sur le côté du boîtier du contrôleur pour changer de programme en cas de perte ou d'absence de batterie de la télécommande.
- Die Taste kann seitlich an dem Controllergehäuse sitzen, um auch bei Verlust der Fernbedienung oder leerer Batterie der Fernbedienung umschalten zu können.
- Possiamo utilizzare il pulsante che si trova sul lato della scatola del regolatore per cambiare il programma in caso di perdita o mancanza di batteria del telecomando.
- Podemos usar o botão situado na lateral da caixa do controlador para mudar o programa, se não soubermos onde está o comando a distância ou este tiver a bateria descarregada.
- Мы можем использовать кнопку на боковой стороне корпуса контроллера, чтобы вносить изменения в программу в случае потери или отсутствия батареи пульта ДУ.
- Możemy użyć przycisku położonego z boku skrzynki kontrolera w celu zmienienia programu w przypadku utraty lub braku baterii pilota zdalnego sterowania.



- Toda la instalación se realiza con conectores estándar.
- The entire installation is carried out using standard connectors.
- Toute l'installation s'effectue à l'aide de connecteurs standard.
- Die Installation erfolgt mit Standardsteckern.
- L'intera installazione viene eseguita con connettori standard.
- Toda a instalação se realiza com conectores standard.
- Все работы по установке выполняются со стандартными соединителями.
- Całą instalację wykonuje się za pomocą standardowych łączników.



- Se incluye un mando a distancia que permite seleccionar colores y secuencias, así como variar la intensidad y la velocidad.
- A remote control for selecting colors and sequences as well as vary the intensity and speed is included.
- Une commande à distance pour la sélection des couleurs et des séquences ainsi que faire varier l'intensité et la vitesse sont inclus.
- Eine Fernbedienung für die Auswahl Farben und Sequenzen sowie variieren die Intensität und Geschwindigkeit sind im Preis inbegriffen.
- Un telecomando per selezionare colori e sequenze nonché variare l'intensità e la velocità sono inclusi.
- Um controle remoto para a seleção de cores e sequências, bem como variar a intensidade ea velocidade estão incluídos.
- unПульт дистанционного управления для выбора цвета и последовательности, а также варьировать интенсивность и скорость включены.
- unPilot zdalnego sterowania do wyboru kolorów i sekwencje, jak również zmieniać intensywność i szybkość są włączone.

RGBEASY+

POSICIONES DEL PROGRAMA / PROGRAMME POSITIONS / POSITIONS DU PROGRAMME / PROGRAMMPOSITIONEN / POSIZIONI DEL PROGRAMMA / POSIÇÕES DO PROGRAMA / ПОЗИЦИИ ПРОГРАММЫ / POŁOŻENIA PROGRAMU

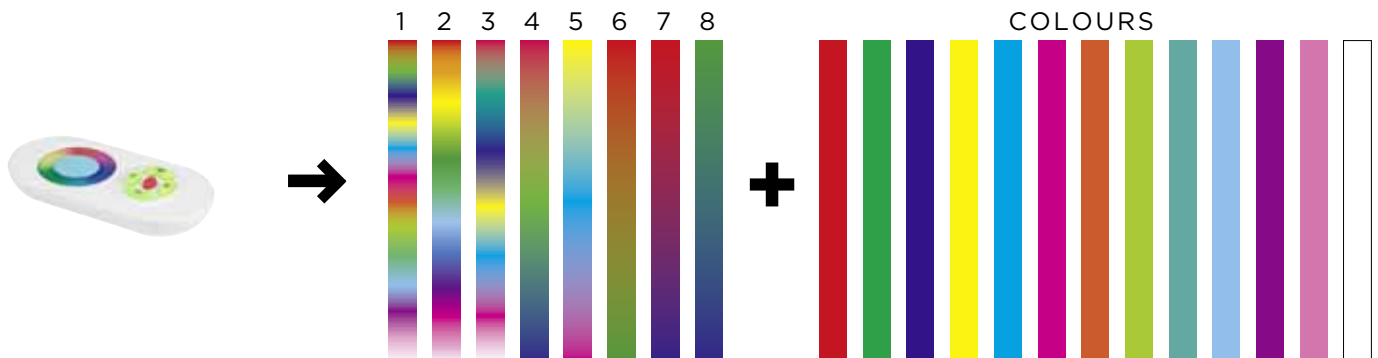
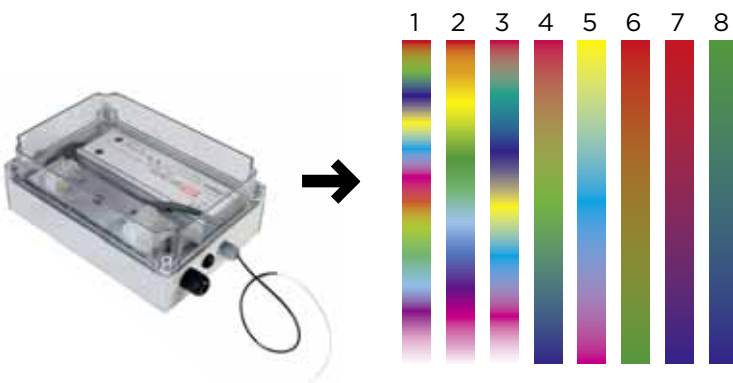

Controladores RGB con mando a distancia / RGB controllers with remote control / Contrôleurs RGB avec télécommande / RGB-Controller mit Fernbedienung / Regolatori RGB con telecomando / Controladores RGB com comando à distância / Контроллеры RGB с пультом дистанционного управления / Kontrolery RGB z pilotem zdalnego sterowania



- Controlador de tiras led con 15 programas RGB predefinidos, anillo de control independiente de 64 colores, cambio de velocidad en programas con secuencia de colores y cambio de intensidad lumínica en programas monocolor. Incorpora un mando a distancia por radiofrecuencia.
- LED stripe controller with 15 pre-set RGB programmes, 64-colour independent control ring, change of speed for programmes with colour sequence and change of light intensity for monochrome programmes. It incorporates a radio-frequency remote control.
- Contrôleur de bandeaux à LED offrant 15 niveaux RGB prédéfinis, un anneau de contrôle indépendant à 64 couleurs, un changement de vitesse pour les programmes à séquence de couleurs, ainsi qu'un changement d'intensité pour les programmes monocolores. Muni d'une télécommande par radiofréquence.
- Reglung von LED-Streifen mit 15 vordefinierten RGB-Programmen, unabhängiger Ring zur Regulierung von 64 Farben, Änderung der Geschwindigkeit bei Programmen mit Farbabfolgen und Änderung der Lichtintensität bei einfarbigen Programmen. Mit Fernbedienung über Funk.

- Regolatori di strisce led con 15 programmi RGB predefiniti, anello di controllo indipendente di 64 colori, cambio di velocità nei programmi con sequenza di colori e cambio di intensità luminosa nei programmi monocolor. Contiene un telecomando a radiofrequenza.
- Controlador de fitas LED con 15 programas RGB predefinidos, anel de controle independente de 64 cores, mudança de velocidade em programas com sequência de cores e mudança de intensidade luminosa em programas monocolor. Incorpora um comando à distância por radiofrequência.
- Контроллер для светодиодных линеек RGB с 15 стандартными программами, кольцом независимого контроля для 64 цветов, смена скорости для многоцветных программ и изменения яркости для одноцветных программ. Включен пульт дистанционного радиоуправления.
- Kontroler taśm LED z 15 wcześniej określonymi programami RGB, obręcz niezależnego sterowania 64 kolorów, zmiana szybkości w programach z sekwencjami kolorów oraz zmiana natężenia oświetlenia w jednobarwnych programach. Zawiera pilot zdalnego sterowania z częstotliwością radiową.

- 1 **Auto colour changing**
- 2
- 3
- 4
- 5
- 6 **Intermitente / Intermittent**
- 7 **Intermitente / Intermittent**
- 8 **Intermitente / Intermittent**
- 9 **Intermitente / Intermittent**
- 10 **Intermitente / Intermittent**
- 11 **Intermitente / Intermittent**
- 12 **White Intermitente / Intermittent white**
- 13
- 14
- 15



71-0019-00-00

12 VDC	216 W	24 x 84 x 65 mm
24 VDC	432 W	

Equipos de control / Device controllers / Contrôleur gradation / Controller / Dispositivi di controllo / Equipamentos de controlo / Контрольные устройства / Osprzet sterujący



71-3493-00-00

12 VDC	24 W	x 4
24 VDC	48 W	

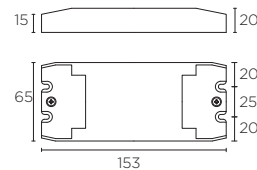

BLANCO / WHITE

Controladores con mando a distancia / Controllers with remote control / Regolatori con telecomando / Controladores com comando à distância / Controller mit Fernbedienung / Контроллеры с пультом дистанционного управления / Kontrolery RGB z pilotem zdalnego sterowania



71-0017-00-00

12 VDC	144 W	24 x 84 x 65 mm
24 VDC	288 W	

•Controlador de tiras led blancas con tres niveles de regulación de intensidad luminica preprogramados (30%, 60%, 100%) y anillo de control independiente de intensidad luminica. Incorpora un mando a distancia por radiofrecuencia.

•White LED strip controller with three pre-set levels for light intensity regulation (30%, 60% and 100%) and light intensity independent control ring. It incorporates a radio-frequency remote control.

•Contrôleur de bandeaux à LED blancs offrant trois niveaux préprogrammés de réglage d'intensité lumineuse (30 %, 60 %, 100 %) et un anneau de contrôle indépendant de l'intensité lumineuse. Muni d'une télécommande par radiofréquence.

•Regler für weiße LED-Streifen mit drei voreingestellten Intensitätsstufen (30 %, 60 %, 100 %) und unabhängigem Kontrollring zur Justierung der Lichtstärke. Mit Fernbedienung über Funk.

•Controlador de fitas LED blancas con três níveis de regulação de intensidade luminosa pré-programados (30%, 60%, 100%) e anel de controlo independente da intensidade luminosa. Incorpora um comando à distância por radio-freqüência.

•Regolatore di strisce led bianche con tre livelli di regolazione di intensità luminosa preprogrammati (30%, 60%, 100%) e anello di controllo indipendente dell'intensità luminosa. Contiene un telecomando a radiofrequenza.

•Контроллер для светодиодных линеек белого света с тремя запрограммированными уровнями яркости (30%, 60%, 100%) и независимое кольцо для контроля яркости освещения. Включен пульт дистанционного радиоуправления.

•Kontroler białych taśm LED o trzech wcześniej programowanych poziomach regulacji natężenia oświetlenia (30%, 60%, 100%) i obręcz niezależnego sterowania natężeniem oświetlenia. Zawiera pilot zdalnego sterowania częstotliwością radiową.

Equipos de control / Device controllers / Contrôleur gradation / Controller / Dispositivi di controllo / Equipamentos de controlo / Контрольные устройства / Osprzet sterujący



71-0727-00-00

12 VDC	2X 78W
24 VDC	2X 156W

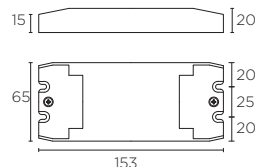

Equipos de control / Device controllers / Contrôleur gradation / Controller / Dispositivi di controllo / Equipamentos de controlo / Контрольные устройства / Osprzet sterujący



71-3473-00-00

12 VDC	60 W
24 VDC	120 W

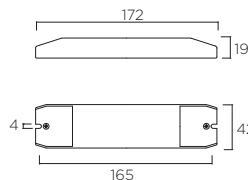

Amplificador / Amplifier / Amplificateur / Verstärker / Amplificatore / Amplificador / Усилитель / Wzmacniacz

RGB / WHITE



71-1553-00-00

12 VDC	4X4 A	IP 20	192 W	48W
24 VDC			384 W	96W CHANNEL

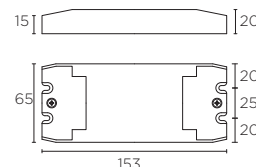



71-9746-05-05 ■

Adecuado para estructuras y columnas cilíndricas de hasta 60 mm de diámetro. / Suitable for cylindrical structures and columns of up to 60 mm in diameter. / Adapté aux structures et colonnes cylindriques de 60 mm de diamètre maximum. / Geeignet für zylinderförmige Strukturen und Säulen bis 60 mm Durchmesser. / Adatto per strutture e colonne cilindriche di fino a 60 mm di diametro. / Adequado para estruturas e colunas cilíndricas com até 60 mm de diámetro. / Подходит для цилиндрических структур и колонн диаметром до 60 мм. / Odpowiedni dla struktur i słupów cylindrycznych o średnicy do 60 mm.

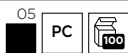

71-9744-05-05 ■

Caja de empotrar específica para techos de hormigón. Válida para / Flush-mounted box for concrete ceilings. Válida para / Boîtier à encastrer spécial plafonds en béton. Valable pour / Spezifisches Einbaugehäuse für Betondecken. Geeignet für. / Scatola per incasso specifica per soffitti in calcestruzzo. Adatto per / Caixa de encastrar específica para tectos de betão. Válida para / Специальная монтажная коробка для бетонных потолков. Подходит для / Specjalna skrzynka do wbudowania dla betonowych sufitów. Stosowna dla: 15-9665 / 55-9665 / 55-9667.

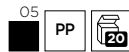

71-9745-05-05 ■

Caja de empotrar específica para techos de hormigón. Válida para / Flush-mounted box for concrete ceilings. Valid for / Boîtier à encastrer spécial plafonds en béton. Valable pour / Spezifisches Einbaugehäuse für Betondecken. Geeignet für. / Scatola per incasso specifica per soffitti in calcestruzzo. Adatto per / Caixa de encastrar específica para tectos de betão. Válida para / Специальная монтажная коробка для бетонных потолков. Подходит для. / Specjalna skrzynka do wbudowania dla betonowych sufitów. Stosowna dla: 15-9392.



71-9199-05-05 ■

Caja de conexiones estanca / Water proof connection box / Boîtier de raccordement étanche / Hermetischer Anschlusskasten / Scatola di connessione a tenuta stagna / Caixa de ligações estanque / Герметичная монтажная коробка / Wodoszczelna skrzynka połączeniowa

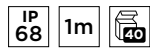

71-9262-05-05 ■

Caja de conexiones estanca. Ø8,5 máx. IP 67 / Water proof connection box. Ø8,5 máx. IP 67 / Boîtier de raccordement étanche / Hermetischer Anschlusskasten / Scatola di connessione a tenuta stagna. Ø8,5 máx. IP 67 / Caixa de ligações estanque. Ø8,5 máx. IP 67 / Соединитель IP 67 3-трехполюсный на три входа / Złącza IP 67 3-y jezdná w kształcie T 3-y biegunowa



71-8969-00-00 □

Reactancia para / Ballast for / Ballast pour / Vorschaltgerät für / Reattanza per / Reactância para / Реактивное сопротивление для / Reaktancja dla: PL G24d-1 13W 230V

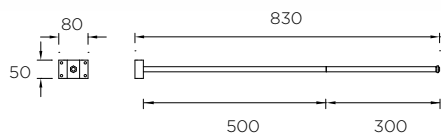

71-9487-34-34 ■
71-9487-Z5-Z5 ■

Brazo prolongador con opción a 3 medidas. / Extension arm with 3 measurements. / Bras de prolongement avec option en 3 dimensions / Verlängerungsarm mit 3 möglichen Abmessungen / Braccio prolunga con possibilità di 3 misure. / Braço de prolongamento com 3 medidas opcionais. / Удлиняющий кронштейн; имеется три размера / Wudłużalne ramię z opcją 3 rozmiarów.



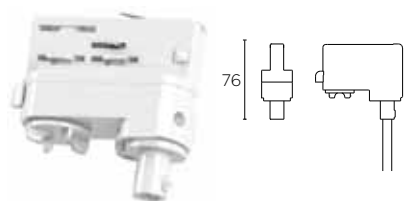

71-2232-14-14
71-2232-60-60

Conector de carril / Track connector / Connecteur de rail / Schienenstecker / Collegamento binari / Conector de calha / Адаптер для шинопровода/ Łącznik szyny



71-2241-00-00

Controlador con mando a distancia / Controller with remote control / Contrôleur avec télécommande / Controller mit Fernbedienung / Regolatore con telecomando / Controlador com comando à distância / Контроллер с дистанционным управлением / Kontroler z pilotem zdalnego sterowania



71-1843-81-81
71-1843-CF-CF

Barras / Bars / Barres / Stangen für / Barre / Barras / Балка / poprzeczki 304 mm.



71-1844-81-81
71-1844-CF-CF

Barras / Bars / Barres / Stangen für / Barre / Barras / Балка / poprzeczki 460 mm.



71-4399-14-14

Mando a distancia / Remote control / Télécommande / Fernbedienung / Telecomando / Comando a distância / Пульт дистанционного радиоуправления / Pilot zdalnego sterowania



71-4933-00-00

Controlador de pared (3 velocidades)/ Wall Control (3 speeds)/ Contrôleur mural (3 vitesses)/ Wandsteuerung (3 Geschwindigkeiten)/ Regolatore da parete (3 velocità)/ Controlador de parede (3 velocidades)/ Настенный контроллер (3 скорости)/ Sterownik ścienny (3 szybkości)



71-4932-00-00

Controlador de pared (3 velocidades y encendido/apagado de la luz)/ Wall Control (3 speeds and light on/off)/ Contrôleur mural (3 vitesses et allumage/extinction de la lumière)/ Wandsteuerung (3 Geschwindigkeiten und Ein/Aus)/ Regolatore da parete (3 velocità e accensione/spengimento della luce)/ Controlador de parede (3 velocidades e ON/OFF da luz)/ Настенный контроллер (3 скорости и включение/выключение света)/ Sterownik ścienny (3 szybkości i zapalenie/gaszenie światła)



71-4933-00-00 / 71-4932-00-00

Compatible con todos los modelos, excepto aquellos con motor DC/ Compatible with all models, except for those with CD engine./ Compatible avec tous les modèles, sauf ceux à moteur CC/ Kompatibel mit allen Modelle, ausgenommen Modelle mit GS-Motor / Compatibile con tutti i modelli, a parte quelli con motore DC/ Compatível com todos os modelos, exceto aqueles com motor DC/ Сочетается со всеми моделями, кроме работающих с двигателем постоянного тока/ Kompatybilny ze wszystkimi modelami, za wyjątkiem tych z silnikiem DC

INFORMACIÓN TÉCNICA / TECHNICAL INFORMATION / INFORMATIONS TECHNIQUES / TECHNISCHE ANGABEN / INFORMAZIONI TECNICHE / INFORMAÇÃO TÉCNICA / ТЕХНИЧЕСКАЯ ИНФОРМАЦИЯ / INFORMACJA TECHNICZNA

- Para mayor información técnica de las piezas incluidas en este catálogo (instrucciones de montaje, diagramas de instalación, etc.), por favor consulte nuestra página web corporativa
- For further technical information about the parts included in this catalogue (assembly instructions, installation diagrams, etc.), please see our corporate website.
- Pour de plus amples informations techniques concernant les pièces de ce catalogue (consignes de montage, schémas d'installation, etc.), veuillez consulter le site Web de notre entreprise.
- Ausführliche technische Daten zu den Artikeln dieses Katalogs (Montageanleitung, Installationsdiagramme usw.) finden Sie auf unserem Internetportal.

- Per ulteriori informazioni tecniche sui prodotti contenuti in questo catalogo (istruzioni di montaggio, diagrammi di installazione, ecc.) si prega di consultare il nostro sito internet.
- Para informações técnicas mais detalhadas sobre as peças incluídas neste catálogo (instruções de montagem, diagramas de instalação, etc.), consulte a nossa página Web empresarial.
- Чтобы подробнее ознакомиться с технической информацией по поводу товаров, включенных в настоящий каталог (инструкции по монтажу, схемы установки и т.п.) посетите наш корпоративный сайт.
- W celu uzyskania szerszej informacji technicznej odnośnie elementów zawartych w niniejszym katalogu (instrukcji montażu, diagramów instalacyjnych, itp.) proszę skonsultować się z naszą korporacyjną stroną internetową

Paso
Step
Étape
Schritt
Step
Passo
Шаг
Krok

1

+  <http://www.leds-c4.com>

Paso
Step
Étape
Schritt
Step
Passo
Шаг
Krok

2

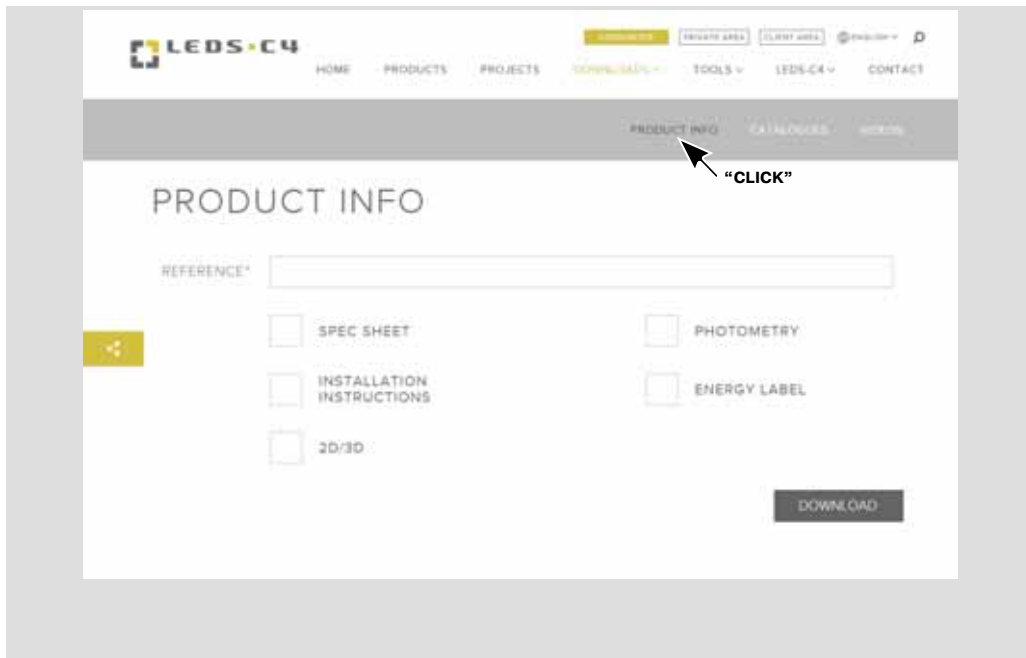

Paso
Step
Étape
Schritt
Step
Passo
Шаг
Krok

3

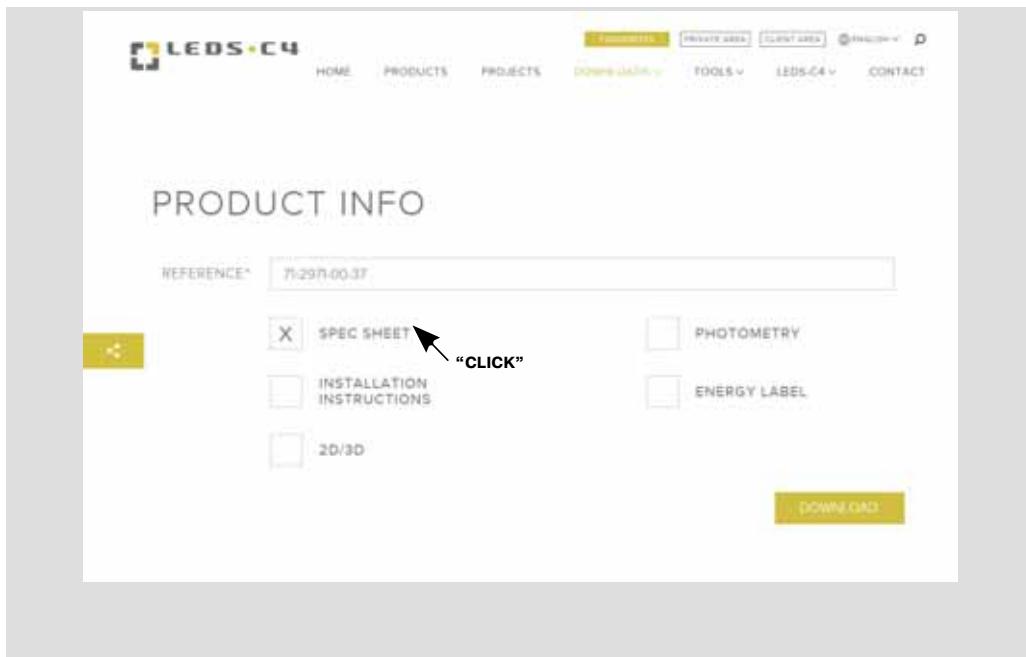



MULTIDIR EVO

71-2971-00-37



Descripción

Kit electrónico con módulo LED (estándar Zhaga) incluido. Para su instalación es necesario completar la luminaria con una de las diferentes carcassas disponibles.

CARACTERÍSTICAS TÉCNICAS

Tipo: ACCESORIO

Orientable: Orientable $\pm 40^\circ$ alrededor de los dos ejes que forman el plano horizontal.

Índice protección IP: IP23

Fuente de luz: 1 x LED Cree 40.2W Blanco cálido - 3000K 3765.4 lm^{lm} CRI 80

Ángulo Óptica / Reflector: 12°

Voltaje / Frecuencia: 1050mA

Garantía (Años): 2

Posibilidad de extensión de garantía: SI, 5 Años

Unidades por caja: 100

EAN: 8435381415682

MATERIALES / ACABADOS

Material estructura: Aluminio Material difusor: Cristal

Acabado estructura: Negro Acabado difusor: Transparente

EQUIPO

Equipo necesario no incluido. Para más información consulte web / catálogos / red comercial.

LM^{lm}: Flujo nominal de la luminaria en condiciones reales de trabajo. Su flujo real dependerá de las condiciones ambientales y de la eficacia de la óptica y/o difusor.

LEDS-C4 se reserva el derecho de realizar las modificaciones técnicas oportunas con el fin de mejorar las prestaciones del producto.

Recomendamos consultar con el equipo comercial para aclarar cualquier duda.

(+34) 973 468 100
leds-c4@leds-c4.com
www.leds-c4.com

71-2952-14-00



Material estructura: Acero
Aluminio

Acabado estructura: Blanco
Blanco

Cuerpo para dos kits electrónicos MULTIDIR EVO L (Ver kits disponibles en apartado Accesorios). Versión para instalación con marco no visible. Aros de rotación e interior en acabado blanco. Tapa posterior ajustable en altura que permite el uso de diferentes fuentes de luz.

IP23

71-2953-14-00



Material estructura: Acero
Aluminio

Acabado estructura: Negro
Negro

Cuerpo para dos kits electrónicos MULTIDIR EVO L (Ver kits disponibles en apartado Accesorios). Versión para instalación con marco no visible. Aros de rotación e interior en acabado negro. Tapa posterior ajustable en altura que permite el uso de diferentes fuentes de luz.

IP23

71-2953-14-00



Material estructura: Acero
Aluminio

Acabado estructura: Blanco
Blanco

Cuerpo para tres kits electrónicos MULTIDIR EVO L (Ver kits disponibles en apartado Accesorios). Versión para instalación con marco no visible. Aros de rotación e interior en acabado blanco. Tapa posterior ajustable en altura que permite el uso de diferentes fuentes de luz.

IP23

71-2953-60-00



Material estructura: Acero
Aluminio

Acabado estructura: Negro
Negro

Cuerpo para tres kits electrónicos MULTIDIR EVO L (Ver kits disponibles en apartado Accesorios). Versión para instalación con marco no visible. Aros de rotación e interior en acabado negro. Tapa posterior ajustable en altura que permite el uso de diferentes fuentes de luz.

IP23

LEDS-C4 se reserva el derecho de realizar las modificaciones técnicas oportunas con el fin de mejorar las prestaciones del producto.

Recomendamos consultar con el equipo comercial para aclarar cualquier duda.

(+34) 973 468 100
leds-c4@leds-c4.com
www.leds-c4.com



Luminaires	Measur.	Lamp
Code 71-2971	Code 90-3294-14-37	Code L2971 40.2W 80 3000K
Name MOD.TDIR EVO LED 40.2W 830 12°	Name Downlight led 21.8W 12° 4000K	Number 1
Line -LEDS C4 LEDES	Date 29-04-2014	Position Universal
Efficiency 100.00%	Coordinate system CG	Total Flux 2934.64 lm
Maximum value 16180.43 cd	Position C=0.00 G=0.00	Double Symmetrical
Round Recessed Luminaire	Diam. 175 mm	Height 2 mm
Round Luminaire Area	Diam. 110 mm	Height 0 mm
Horizontal Luminous Area	0.009503 m ²	Emitting area on Plane 180° 0.000000 m ²
Emitting area on Plane 0°	0.000000 m ²	Emitting area on Plane 270° 0.000000 m ²
Emitting area on Plane 90°	0.000000 m ²	Glare area at 10° 0.002259 m ²
Symmetry Type	Double Symmetrical	Maximum Gamma Angle 90
Measurement Distance	6.44	Measurement Flux 1842.43 lm
Operator Assalum T2	Source voltage 26.00 V	36.00 V
Temperature 55.00 %	Source current Photocell	0.60 A
Notes		Pfc

Line	Code	Name	Flux (lm)	Pow. (W)	C ty
LEDS C4 LEDES	L2971 40.2W 80 3000K	Lámpara leds 40.2W 3000K	2934.64	40.00	1
C.U.L.	95	100	100	100	100
F.U.T.E.	1.00	A			

Diam=175mm Incasso

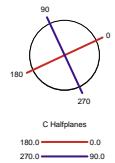

C Halfplanes: 180.0 - 0.0, 270.0 - 90.0

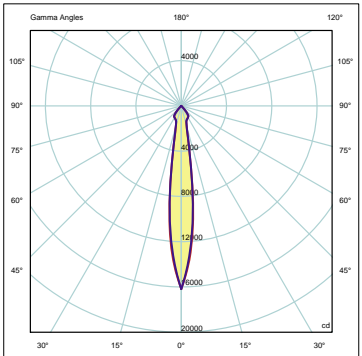

Gamma Angles: 180°, 120°, 105°, 90°, 75°, 60°, 45°, 30°, 15°, 0°, 15°, 30°

LLOR 0.00 %
CLOR 100.00 %
RN 0.00 %

LITESTAR (c)OxyTech Srl www.oxytech.it Page 1

1
MULTIDIR EVO

MULTIDIR STRUCTURES

KIT GU10 KIT GX8.5 KIT LED / LED AC KIT G53 KIT G8.5 KIT GU5.3

TRIM TRIMLESS OFF

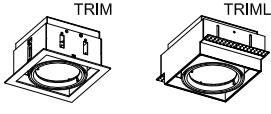

LED / LED AC

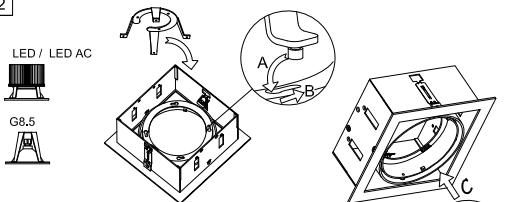

G8.5

OPTIONAL

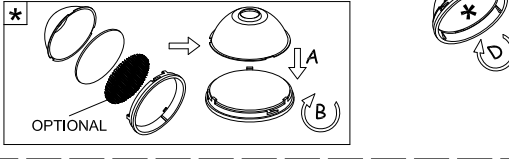

GU10 GX8.5 G53 GU5.3

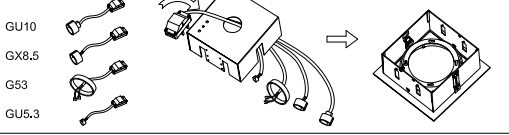

02-12-2013

TECHNICAL INFORMATION

EMPOTRABLES DE TIERRA - DRENAJE

Es imprescindible seguir las instrucciones de montaje y la guía de instalación de los empotrables para lograr el mejor funcionamiento posible de la luminaria.

1. Evitar colocar las luminarias en zonas de depresión del terreno.
2. Evitar colocar las luminarias en zonas donde se pueda acumular agua y en ubicaciones permanentemente húmedas, como jardines o césped.
3. Evitar el uso de productos químicos utilizados para el abono de jardines ya que pueden deteriorar algunos componentes.
4. Nivelar la luminaria con el pavimento.
5. Prever un recubrimiento de dilatación en el caso de empotrables colocados en superficies como el cemento o el hormigón para evitar la posible dilatación o compresión.
6. Colocar un drenaje eficaz para evitar el estancamiento de agua, como mínimo de 25 centímetros de grava por debajo de la carcasa de instalación. Un drenaje correcto debe absorber hasta 10 litros de agua en 15 minutos.
7. Hacer funcionar la luminaria durante 20 minutos sin el cristal para evitar condensaciones de agua dentro.

BUILT-IN FLOOR LUMINAIRES - DRAINAGE

It is essential to follow the assembling instructions and the installation guide of the built-in luminaires in order to achieve the best performance.

1. Avoid installing the luminaires in terrain depressions.
2. Avoid installing the luminaires in areas where water can accumulate and in places that are permanently damp, such as gardens or lawns.
3. Avoid the use of chemical products used to fertilise gardens because they could damage some of the components.
4. Level the luminaire with the surface.
5. Anticipate a dilation coating for built-in luminaires installed on surfaces like cement or concrete, to avoid possible dilation or compression.
6. Install an effective drainage system to avoid the accumulation of water, at least 25 cm of gravel under the installation casing. A correct drainage must absorb up to 10 litres of water in 15 minutes.
7. Put the light on for 20 minutes without the glass to avoid condensation inside.

ENCASTRABLES AU SOL - DRAINAGE

Il est indispensable de suivre les instructions et le guide d'installation des encastrables afin de garantir un éclairage optimum.

1. Eviter l'installation de luminaires dans des zones de dépression de terrain.
2. Eviter l'installation de luminaires dans des espaces où s'accumule de l'eau ou des zones humides telles que jardins ou pelouses.
3. Eviter l'utilisation de produits chimiques utilisés pour le compostage des jardins car ils peuvent détériorer certains composants.
4. Nivelar le terrain en vue de l'installation des luminaires.
5. Prévoir un recouvrement pour la dilatation dans le cas de luminaires encastrables installés en surface tel que le ciment ou le béton, afin d'éviter une possible dilatation ou compression.
6. Poser un drain efficace afin d'éviter toute stagnation de l'eau, avec un minimum de 25 centimètres de gravier en dessous de l'installation. Un drain efficace doit permettre d'absorber jusqu'à 10 litres d'eau en 15 minutes.
7. Faire fonctionner le luminaire pendant 20 minutes, sans le verre, afin d'éviter toute condensation d'eau à l'intérieur.

BODENEINBAULEUCHTEN - DRAINAGE

Die Montageanweisungen und Anleitungen des Handbuchs für die Installation der Bodeneinbauleuchten sind unbedingt zu befolgen, um den bestmöglichen Betrieb der Leuchtungskörper gewährleisten zu können.

1. Vermeiden Sie die Montage der Leuchtungskörper in abschüssigem Gelände.
2. Vermeiden Sie die Montage der Leuchtungskörper in Bereichen der Wasserransammlung und in Feuchtzonen, wie Gärten und Rasenflächen.
3. Vermeiden Sie die Verwendung von chemischen Gartendüngemitteln, da diese einen schädlichen Einfluss auf einige der Komponenten ausüben können.
4. Bringen Sie den Leuchtungskörper und den Bodenbelag auf eine Höhe.
5. Sorgen Sie beim Einbau der Leuchtungskörper in Zement- oder Betonflächen für eine geeignete Ummantelung, um eine eventuelle Ausdehnung oder ein Zusammenpressen zu verhindern.
6. Bauen Sie ein wirksames Drainagesystem ein, um das Anstauen von Wasser zu vermeiden, wobei ein Kiesbett von mindestens 25 cm unter dem Einbaugeschäube vorhanden sein muss. Bei einer korrekten Drainage müssen bis zu 10 Liter Wasser in 15 Minuten absorbiert werden.
7. Nehmen Sie den Leuchtungskörper 20 Minuten lang ohne Deckglas in Betrieb, um eine Kondensierung des Wassers im Inneren der Leuchte zu vermeiden.

ELEMENTI DA INCASSARE AL SUOLO - DRENAGGIO

È indispensabile seguire le istruzioni di montaggio e la guida di installazione degli elementi ad incasso per garantire il migliore funzionamento possibile.

1. Evitare di collocare i faretti in zone depresse del terreno.
2. Evitare di collocare i faretti in zone in cui possa accumularsi acqua e in ubicazioni permanentemente umide, come giardini o prati.
3. Evitare l'uso dei prodotti chimici usati per la concimazione di giardini, dal momento che potrebbero deteriorare alcuni componenti del faretto.
4. Collocare il faretto a livello del suolo.
5. Prevedere una giunta di dilatazione nel caso di elementi ad incasso collocati in superfici come cemento e calcestruzzo, per evitare la possibile dilatazione o compressione.
6. Disporre un drenaggio efficace per evitare il ristagno dell'acqua, come minimo di 25 centimetri di ghiaia al di sotto della carcassa di installazione. Un drenaggio corretto deve assorbire fino a 10 litri di acqua in 15 minuti.
7. Far funzionare il faretto per 20 minuti senza il vetro per evitare che al suo interno di formi condensazione.

ENCASTRÁVEIS DE TERRA - DRENAGEM

É imprescindível que siga as instruções de montagem e o guia de instalação dos encastráveis para obter o melhor funcionamento possível do aparelho de iluminação.

1. Evite colocar os aparelhos de iluminação em zonas de depressão do terreno.
2. Evite Coloque os aparelhos de iluminação em zonas onde se possa acumular água e em localizações permanentemente húmidas, como jardins ou relva.
3. Evite o uso de produtos químicos utilizados para o adubamento de jardins, dado que eles podem deteriorar alguns componentes.
4. Nivele o aparelho de iluminação pelo pavimento.
5. Preveja um revestimento de dilatação no caso de encastráveis colocados em superfícies como o cimento ou o betão para evitar a eventual dilatação ou compressão.
6. Coloque uma drenagem eficaz para evitar a estagnação da água, no mínimo de 25 centímetros de gravilha abaixo da carcassa de instalação. Uma drenagem correcta deve absorver até 10 litros de água em 15 minutos.
7. Faça funcionar o aparelho de iluminação durante 20 minutos sem o vidro para evitar condensações de água dentro dele.

ВСТРОЕННЫЕ НАПОЛЬНЫЕ ОСВЕТИТЕЛЬНЫЕ ПРИБОРЫ - ДРЕНАЖ

Для обеспечения оптимальной работы осветительного прибора необходимо в точности следовать инструкциям и пособию по установке для встроенных приборов.

1. Не устанавливайте осветительные приборы во впадинах.
2. Не устанавливайте осветительные приборы на участках, предрасположенных к скоплению воды и в местах с повышенным содержанием влаги, таких, как, например, сады или газоны.
3. Попадание химических удобрений, используемых для садовых растений, может повредить поверхность лампы.
4. Устанавливайте осветительные приборы на уровне поверхности.
5. Предусмотреть нанесение покрытия в случае установки осветительных приборов на таких поверхностях как цемент или бетон, для предотвращения возможного расширения или сжатия.
6. Установить эффективный дренаж для задержки воды, как минимум в 25 см гравия расположенного под структурой осветительного прибора. Адекватная дренажная система должна абсорбировать до 10 литров воды в течении 15 минут
7. Включить осветительный прибор за 20 минут до установки стекла для предотвращения водной конденсации.

WBUDOWYWANE OPRAWY PODŁOGOWE - DRENAŻ

Aby osiągnąć najlepszą wydajność należy bezwzględnie stosować się do instrukcji montażu lamp wbudowywanych.

1. Unikać montowania opraw w zagłębieniach terenu.
2. Unikać stosowania opraw w miejscach gdzie często zbiera się woda lub miejscach wilgotnych takich jak ogrody i trawniki.
3. Unikać kontaktu opraw z nawozami, ponieważ mogą one zniszczyć części opraw.
4. Wypoziomować oprawę.
5. Zastosować przerwy dylatacyjne przy montażu opraw w betonie, aby zapobiec ścisłaniu i rozszerzaniu.
6. Zastosować system drenażowy pod oprawą – co najmniej 25cm wiru pod dnem oprawy. Właściwy drenaż powinien przepuszczać 10 litrów wody w 15 min.
7. U uruchom lampę na 20 minut bez przykrycia celem odparowania wilgoci.





TABLA DE RESISTENCIA A LA CORROSIÓN ACERO INOXIDABLE / CORROSION RESISTANCE TABLE OF STAINLESS STEEL / TABLEAU DE RÉSISTANCE À LA CORROSION DE L'ACIER INOXYDABLE / KORROSIONSFESTE PLATTE AUS ROSTFREIEM STAHL / TABOLA DI RESISTENZA ALLA CORROSIONE DELL'ACCIAIO / TABELA DE RESISTÊNCIA À CORROÇÃO DO AÇO INOXIDÁVEL / ТАБЛИЦА О ЖАВУОУСТОЙЧИВОСТИ НЕРЖАВЕЮЩЕЙ СТАЛИ / TABELA OCHRONY ANTYKOROZYJNEJ STALI NIERDZEWNEJ

	AISI 202	AISI 304	AISI 316		AISI 202	AISI 304	AISI 316
Agua doméstica / Domestic water / Eau ménagère / Haushaltswasser / Acqua domestica / Água doméstica / Хозяйственно-бытовая вода / Woda domowa	OK	OK	OK	Vapor de agua / Water vapor / Vapeur d'eau / Wasserdampf / Vapore di acqua / Vapor de água / Пап / Para wodna	OK	OK	OK
Agua doméstica conteniendo cloro / Domestic water containing chloride / Eau ménagère contenant du chlore / Chlorenhaltendes Haushaltswasser / Acqua domestica contenente di cloro / Água doméstica contendo cloro / Хозяйственно-бытовая вода с хлором / Woda domowa z chlorem	X	X	OK	Limpiadores químicos quita cemento / Chemical cleaning for use on cement / Nettoyeurs chimiques lève ciment / Chemische Reiniger zur Zemententfernung / Prodotti chimici di pulizia per il cemento / Limpadores químicos para a remoção de cimento / Химические чистящие средства для цемента / Środki czyszczące do betonu	X	X	X
Agua de mar / Sea water / Eau de mer / Meerwasser / Acqua di mare / Água do mar / Морская вода / Woda morską	X	X	OK	Suelos con un PH alto o alcalinos / Floors with high PH or alkaline values / Terres avec un pH haut ou alcalins / Böden mit hohem PH-Wert oder alkalische Böden / Pavimenti con alto PH ed alcalini / Terrenos com um PH alto ou alcalinos / Поверхности с высоким водородным показателем или щелочные / Podłogi o wysokim pH i odczynie kwasowym	X	X	OK
Aire / Air / Air / Luft / Aria / Ar / Воздух / Powietrze	OK	OK	OK	Fertilizantes y abonos químicos / Fertilizers and chemical fertilizers / Fertilizantes e engrais químicos / Düngemittel und chemische Dünger / Fertilizantese e prodotti chimici / Fertilizantes e adubos químicos / Удобрения и химические удобрения / Nawozy i nawozy sztuczne	X	X	X
Atmósfera marina / Marine atmosphere / Atmosphère marine / Meeresatmosphäre / Atmosfera marina / Atmosfera marinha / Приморская атмосфера / Powietrze nadmorskie	X	X	OK				

LIMPIEZA Y MANTENIMIENTO DEL ACERO INOXIDABLE

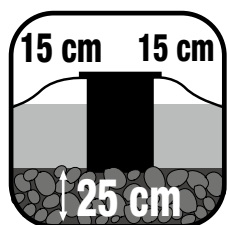
Por su excelente resistencia y belleza, el acero inoxidable es un material de fácil conservación, tendiéndose a veces a tener la errónea idea de que no requiere mantenimiento. Pero es necesario seguir unas recomendaciones mínimas durante su almacenamiento, manipulación y uso. Una limpieza adecuada permite mantener inalteradas sus características originales, preservando su resistencia a la corrosión y apariencia.

Durante las tareas de limpieza, asegurar que se eliminan las acumulaciones de contaminantes llevados por el aire. Esto es muy importante en lugares industriales o marítimos ya que pueden provocar corrosión localizada si no se eliminan eficazmente.

Para eliminar la suciedad sobre la superficie, se debe utilizar un paño húmedo o una gamuza. En caso de suciedad más difícil, utilizar detergentes suaves de uso doméstico con estropajos o cepillos suaves de nylon (no usar estropajos de acero). Después de limpiar, elimine los residuos con agua desionizada y seque la superficie.

La frecuencia para una limpieza regular es de 6-12 meses para una suciedad moderada y de 3-6 meses cuando es más abundante, o para ambientes en que se den las siguientes condiciones:

- atmósferas marinas - ambientes repletos de contaminantes industriales - sal pulverizada proveniente de la sal utilizada en carreteras - suciedad atmosférica y del tráfico.
No deben usarse limpiadores que contengan cloruros ni lejías.

Encontrará información más detallada en: www.leds-c4.com

CLEANING AND MAINTENANCE OF STAINLESS STEEL

Stainless steel is a highly resistant beautiful material being easy to conserve. However, it does require maintenance. For this reason, it is necessary to follow some minimum recommendations during its storage, manipulation and use. Correct cleaning preserves its original characteristics, especially its resistance to corrosion.

During cleaning it is important to clean the contaminating agents which are present in the atmosphere. This is particularly the case in industrial places or close to a marine environment, as these areas can cause localized corrosion if they are not efficiently eliminated.

A damp cloth or chamois leather cloth should be used to eliminate the dirt on the surface. In case of extra dirt, gentle detergents suitable for domestic use should be used with non abrasive scrubbers or nylon brushes (no metal scrubbers). After cleaning wipe away the residue with water and dry surface. The recommended frequency is every 6-12 months for moderate dirt and 3-6 months for heavy dirt or for the following situation:

- Marine atmosphere - Industrial contaminated areas - Salt from road gritting - Dirt from traffic.
No cleaning agents that contain chloride or bleach should be used

You can find further information at: www.leds-c4.com

NETTOYAGE ET ENTRETIEN DE L'ACIER INOXYDABLE

Du fait de son excellente résistance et de sa beauté, l'acier inoxydable est un matériau facile à conserver. Il exige toutefois plus d'entretien qu'on ne le pense. Il convient de respecter des consignes élémentaires pendant le stockage, la manipulation et l'utilisation de ce matériau. Un nettoyage adéquat permet d'en maintenir les caractéristiques initiales inchangées et d'en préserver la résistance à la corrosion ainsi que l'apparence.

Pendant le nettoyage, veillez à éliminer les accumulations de contaminants présents dans l'air. Cela est très important en milieu industriel ou marin car ces particules risquent de provoquer une corrosion localisée si elles ne sont pas éliminées efficacement.

Pour éliminer les salissures de la surface, il convient d'utiliser un chiffon humide ou une peau de chamois. En cas d'impuretés plus tenaces, utilisez des détergents doux à usage ménager combinés à des éponges ou brosses douces en nylon (pas d'éponge métallique). Après le nettoyage, éliminez les résidus avec de l'eau déionisée et séchez la surface.

Il est conseillé de nettoyer tous les 6-12 mois en cas de salissures modérées et tous les 3-6 mois en cas de salissures plus incrustées ainsi que dans les circonstances suivantes : milieu marin, milieu riche en contaminants industriels, projections de sel d'épandage, impuretés atmosphériques et dues à la circulation routière.

N'utilisez pas de produits nettoyants contenant des chlorures ou de l'eau de javel.
Vous trouverez de plus amples informations sur le site : www.leds-c4.com

REINIGUNG UND INSTANDHALTUNG VON ROSTFREIEM STAHL

Aufgrund seiner hohen Beständigkeit und seines attraktiven Erscheinungsbildes ist rostfreier Stahl ein einfacher Instand zu haltendes Material. Viele neigen daher zur irrürlichen Annahme, dass rostfreier Stahl keine Wartung benötigt. Nichtsdestoweniger sollte man sich bei seiner Lagerung, Handhabung und seinem Gebrauch an gewisse Mindestanforderungen halten. Eine angemessene Reinigung trägt dazu bei, seine Eigenschaften im ursprünglichen Zustand zu erhalten, seine Korrosionsbeständigkeit zu erhöhen und sein attraktives Aussehen zu bewahren.

Während der Reinigung sollte man darauf achten, dass alle verunreinigenden Stoffe, die durch die Luft auf das Metall übertragen wurden, vollkommen entfernt werden. Dies ist besonders in den Bereichen der Industrie und der Seefahrt wichtig, denn werden diese Stoffe nicht auf wirksame Weise entfernt, so können sie an bestimmten Stellen Korrosionserscheinungen hervorrufen.

Für die Entfernung der Verunreinigungen von der Oberfläche ist ein feuchtes Tuch oder ein Wischlappen zu benutzen. Bei hartnäckigem Schmutz können milde Haushaltsreiniger mit weichen Scheuerlappen oder Nylonbürsten (keine Scheuerschwämme aus Stahl verwenden) eingesetzt werden. Danach müssen die Rückstände des Reinigers mit entionisiertem Wasser abgespült und die Oberfläche abgetrocknet werden.

Eine regelmäßige Reinigung sollte bei mäßigem Schmutzbefall alle 6-12 Monate durchgeführt werden, bzw. alle 3-6 Monate bei stärkerem Schmutzbefall oder bei Vorliegen der folgenden Bedingungen:

- im Meerwasserbereich - in Bereichen mit starker industriell bedingter Verschmutzung - bei Einwirkung von Streusalz, das auf den Straßen eingesetzt wird - wetter- oder verkehrsbedingter Schmutzbefall.

Es dürfen keine Reiniger benutzt werden, die Chloride oder Laugen enthalten.
Ausführlichere Information finden Sie in: www.leds-c4.com

PULIZIA E MANTENIMENTO DELL'ACCIAIO INOSSIDABILE

Per sua particolare resistenza e bellezza, l'acciaio inossidabile è un materiale di facile conservazione, è però necessaria una po' di manutenzione.

È necessario seguire qualche raccomandazione durante l'immagazzinamento, manipolazione ed uso. La pulizia appropriata permette di conservare la sua caratteristica originale, non solo la resistenza alla corrosione ed il suo aspetto.

Durante la pulizia, bisogna assicurarsi che gli accumuli di sostanze contaminanti portate dall'aria siano rimossi. Ciò è particolarmente importante in ambienti marini ed industriali, questi possono dar luogo a corrosione localizzata, se non rimossi accuratamente.

Per rimuovere uno sporco leggero o le impronte, è consigliabile usare un panno umido o di pelle scamosciata. Invece per lo sporco più consistente è consigliabile usare dei prodotti di uso domestico, spugnette oppure spazzole soffici (assolutamente non usare pagliette abrasive o metalliche). Dopo aver effettuato un'opportuna pulizia, rimuovere i residui con acqua preferibilmente deionizzata ed asciugare.

Si consiglia una pulizia ogni 6-12 mesi per uno sporco leggero, ed ogni 3-6 mesi per quello più pesante derivante dagli ambienti sotto citati:

- atmosfere marine - ambienti carichi di prodotti industriali inquinanti - spruzzi di acqua contenenti il sale antighiaccio sparso sulle strade - inquinamento atmosferico e da traffico.
Non devono essere usati dei prodotti contenenti cloruri e neanche candeggine a base di acido ipoclorico.

Troverete informazioni più specifiche sul sito: www.leds-c4.com

LIMPEZA E MANUTENÇÃO DO AÇO INOXIDÁVEL

Dada a sua excelente resistência e beleza, o aço inoxidável é um material de conservação fácil, tendendo-se por vezes a ficar com a ideia de que não necessita de manutenção. No entanto é necessário que se sigam recomendações mínimas durante o seu armazenamento, manuseamento e uso. Uma limpeza adequada permite que se mantenham inalteradas as suas características originais, preservando a sua resistência à corrosão e o seu aspecto.

Durante as tarefas de limpeza, certifique-se de que são eliminadas as acumulções de contaminantes transportados pelo ar. Isto é muito importante em locais industriais ou marítimos, dado que tais contaminantes podem provocar corrosão localizada se não forem eficazmente eliminados.

Para eliminar a sujidade existente à sua superfície, deve-se utilizar um pano húmido ou uma camurça. No caso de sujidade mais difícil, devem ser utilizados detergentes suaves de uso doméstico, com esfregões ou escovas suaves de nylon (não se devem usar esfregões de aço). Depois da limpeza, devem ser eliminados os resíduos com água desionizada e secar a superfície.

Para uma limpeza regular, a frequência é de 6-12 meses para sujidade moderada e de 3-6 meses para sujidade mais abundante, ou para ambientes em que se verifiquem as condições seguintes:

- atmosferas marinhas - ambientes repletos de contaminantes industriais - sal pulverizado proveniente do sal utilizado nas estradas - sujidade atmosférica e do trânsito.
Não se devem usar produtos de limpeza que contêmham cloruros ou lixívia.

Pode encontrar informações mais detalhadas em: www.leds-c4.com

ЧИСТКА И УХОД ЗА НЕРЖАВЕЮЩЕЙ СТАЛЬЮ

Благодаря своим эстетическим характеристикам и долгоизнашиваемости, нержавеющая сталь является материалом, способным при ее правильном уходе сохранять свой первоначальный вид очень долгое время. Необходимо придерживаться минимальных рекомендаций распространяющихся на уход, хранение и использование. Адекватная чистка позволит сохранить первоначальные качества, а также внешний вид и устойчивость к ржавчине. В процессе чистки обратите внимание на удаление с поверхности всего накопившегося загрязнения.

Важно следовать этому требованию в промышленных или приморских районах, так как неправильная чистка может привести к образованию ржавчины. Используйте влажную тряпку или кусок замши для удаления грязи с поверхности. При особом загрязнении используйте мягкие моющие средства для домашнего пользования, и мягкие скрепки или нейлоновые щетки (не допускается использование металлических щеток). После чистки сполосните водой и высушите поверхность.

При среднем загрязнении чистка должна производиться через каждые 6-12 месяцев, и каждые 3-6 месяцев при сильном загрязнении или при наличии следующих условий окружающей среды:

- приморский район - при сильном промышленном загрязнении - использовании соли на дорогах.
Не использовать чистящие средства, содержащие хлор или отбеливатель.
Вы сможете получить дополнительную информацию, зайдя на интернет-страницу www.leds-c4.com

CSZYSZCENIE I KONSERWACJA STALI NIERDZEWNEJ

Stal nierdzewna to piękny i wysoce odporny materiał łatwy w konserwacji. Mimo to, należy o niego dbać. Dlatego ważne jest aby przestrzegać kilku zasad przy przechowywaniu, obróbce i używaniu stali nierdzewnej. Właściwe czyszczenie utrzymuje właściwości fizyczne, a w szczególności odporność na korozję.

Czyszcząc ważne jest usuwanie substancji niekorzystnie wpływających na stal, obecnych w atmosferze. Ważne jest to zwłaszcza w otoczeniu przemysłowym lub morskim, gdzie niedokładnie wyuczyszczone powierzchnie mogą powodować miejscową korozję. Wilgotna ściereczka, lub ściereczka zamszowa powinny być używane do czyszczenia stali nierdzewnej. W przypadku mocniejszych zabrudzeń można użyć domowych detergentów i nie metalowej szkrabki. Po czyszczeniu należy powierzchnię zmyć wodą i wytrzeć do sucha. Zaleca się czyszczenie co 6-12 miesięcy przy niskim zanieczyszczeniu, i co 3-6 miesięcy przy wysokim zanieczyszczeniu lub w następujących warunkach:

- morska atmosfera - miejsca skażone przemysłowo - sól do posypywania dróg - bród z ruchu kołowego
- Nie stosować środków zawierających chlor lub wybielacz.





























Więcej informacji na www.leds-polska.pl

	ESPAÑOL	ENGLISH	FRANÇAIS	DEUTSCH
	Clase I	Class I	Classe I	Klasse I
	Clase II	Class II	Classe II	Klasse II
	Clase III	Class III	Classe III	Klasse III
	Sistema de codificación para indicar el grado de protección proporcionado por un envoltorio contra la entrada de elementos sólidos y líquidos	A coding system that shows the degree of protection that a casing provides against the penetration of solid objects or dust and liquids	Système de codification permettant d'indiquer le degré de protection procuré par une enveloppe contre la pénétration de corps solides, poussières et liquides	Dieses Codierungssystem dient zur Angabe des Schutzgrades, der mit einer besonderen Verkleidung zum Schutz gegen das Eindringen fester Gegenstände, Staub oder Flüssigkeiten erreicht wird
	Sistema de codificación para indicar el grado de protección proporcionado por un envoltorio contra los impactos mecánicos nocivos. Energía de impacto (Jules)	It is a coding system that shows the level of protection that a casing provides against damaging mechanical impacts. Energy of impact (Jules)	Système de codification permettant d'indiquer le degré de protection procuré par une enveloppe contre les impacts mécaniques nuisibles. Energie d'impact (en Joules)	Dieses Codierungssystem dient zur Angabe des Schutzgrades, der mit einer besonderen Verkleidung zum Schutz gegen schädliche mechanische Einflüsse erreicht wird. Schlagenergie (Joule)
	Luminarias no adecuadas para cubrirse con material aislante térmico	Luminaires should never be covered with any heat insulating material	Ces luminaires ne doivent pas être recouverts de matériau thermo-isolant	Leuchte nicht geeignet zur Abdeckung mit Wärmeisoliermaterial
	Luminarias no adecuadas para el montaje directo en superficies normalmente inflamables	Non suitable for direct installation on normally inflammable surfaces	Luminaires non destinés à une installation directe sur des surfaces normalement inflammables	Montage auf normal entflammabaren Oberflächen nicht zulässig
	Resistente al hilo incandescente a 850°C	Resistance to incandescent wire at 850°C	Tenue au feu 850°C	Glühdrahtbeständig auf 850°C
	Distancia mínima entre el foco de la luminaria y el objeto iluminado	Minimum distance to be left between the focus of the lighting fixture and the lightened object	Distance minimale entre le foyer du luminaire et l'objet éclairé	Mindestabstand zwischen dem Scheinwerfer der Leuchte und dem beleuchteten Gegenstand
	Uso independiente	Independent use	Utilisation indépendante	Unabhängiger Betrieb
	Diámetro de empotramiento	Hole diameter for recessing	Diamètre d'encastrement	Einbaudurchmesser
	Corte de empotramiento	Hole dimensions for recessing	Coupe d'encastrement	Einbauschnitt
	Los anclajes permiten su instalación en techos de X mm a X mm	The fixing can be used on X mm - X mm ceilings	Les fixations permettent d'installer le modèle sur des plafonds de X à X mm	Die Federn gestatten eine Installation an Decken von X mm bis X mm
	Equipo no incluido	Gear not included	Équipement non compris	Vorschaltgerät nicht inklusive
	Equipo electrónico	Electronic gear	Équipement électronique	Elektronisches Vorschaltgerät
	Equipo magnético	Magnetic gear	Équipement magnétique	Magnetisches Vorschaltgerät
	Unidades de embalaje	Items per box	Unité d'emballage	Verpackungseinheiten
	Ver página xxx	See page xxx	Voir page XXX	Siehe Seite XXX
	Modelos registrados	Registered models	Modèles enregistrés	Eingetragene Modelle
Lm	Flujo nominal bajo condiciones reales de trabajo (Tj=85°)	Design flow under real working conditions (Tj=85°)	Flux nominal dans des conditions réelles de fonctionnement (Tj=85°)	Nennlichtstrom unter tatsächlichen Betriebsbedingungen (Tj=85°)
	Regulador de intensidad	Dimmer	Régulateur d'intensité	Mit Dimmer
	Consultar disponibilidad	Check availability	Vérifiez la disponibilité	Bitte nach Verfügbarkeit fragen
	Eficiencia	Efficiency	Efficienc	Effizienz
	Tensión de entrada	Supply voltage	Tension d'entrée	Eingangsspannung



























	ITALIANO	PORTUGUÊS	РУССКИЙ ЯЗЫК	POLSKI
	Classe I	Classe I	Класс I	Klasa I
	Classe II	Classe II	Класс II	Klasa II
	Classe III	Classe III	Класс III	Klasa III
	Sistema di codificazione per indicare il grado di protezione offerto da un involucro contro la penetrazione di oggetti solidi, di polvere, o di liquidi	Sistema de codificação para a indicação do grau de protecção proporcionado por um invólucro contra a penetração de objectos sólidos ou pó e líquidos	Система кодирования для обозначения степени защиты корпуса от попадания твердых и жидких элементов	System kodowania wskazujący na stopień ochrony przed wnikaniem ciał obcych, kurzu i wody
	Sistema di codificazione per indicare il grado di protezione fornito da un rivestimento contro gli impatti meccanici dannosi. Energia di impatto (Joule)	Sistema de codificação para indicar o grau de protecção proporcionado por um invólucro contra os impactos mecânicos nocivos. Energia de impacto (Jules)	Система кодирования для обозначения степени защиты корпуса от механических ударов. Сила удара (в Дж)	System kodowania dla wskazania stopnia ochrony obudowy przed szkodliwymi uderzeniami mechanicznymi (Dzule)
	Apparecchi inappropriati per essere coperti con materiale isolante termico	Estas luminárias não podem ser cobertas com material isolante térmico	Не допускается теплоизоляция данных светильников	Oprawy nigdy nie powinny być przykrywane materiałem izolującym ciepło
	Apparecchi inappropriati per montaggio su superfici infiammabili	Estas luminárias não podem ser montadas diretamente sobre superfícies normalmente inflamáveis	Не допускается установка данных светильников на легковоспламеняющихся поверхностях	Nie instalować bezpośrednio na powierzchniach łatwopalnych.
	Resistente al filo incandescente 850°C	Resistente ao fio incandescente a 850°C	Прошло испытание спиралью накаливания 850°C	Odpornośćna drut żarowy o temperaturze 850°C
	Distanza minima tra la lampada e l'oggetto illuminato	Distância mínima entre o foco da luminária e o objecto iluminado	Минимальное расстояние между световым фокусом и освещаемым объектом	Minimalna odległość do zachowania pomiędzy czołem lampy a oświetlanym obiektem
	Uso indipendente	Utilização independente	Независимое использование	Niezależne zastosowanie
	Diametro di incasso	Diâmetro de encastramento	Диаметр отверстия для встраиваемого монтажа	Średnica wbudowania
	Foro di incasso	Corte de encastramento	Размер отверстия для встраиваемого монтажа	Przekrój wbudowania
	I fissaggi consentono l'installazione dell'articolo su soffitti da X mm a X mm	As fixações permitem a sua instalação em tectos de X mm a X mm	Зажимы обеспечивают монтаж в потолок толщиной от X мм до X мм	Kotwienia pozwalają na jego zainstalowanie na sufitach wynoszących od X mm do X mm
	Trasformatore non incluso	Equipamento não incluído	Оборудование не включено	Zasilacz nie dołączony
	Trasformatore elettronico	Aparelho electrónico	Электронный балласт	Osprzęt elektroniczny
	Trasformatore magnetico	Equipamento magnético	Магнитный балласт	Osprzęt magnetyczny
	Unità d'imballaggio	Uds. de embalagem	Количество единиц в коробке	Sztuk w pudełku
	Consultare pagina XXX	Ver página XXX	См. стр. XXX	Zobacz stronę XXX
	Modelli registrati	Modelos registados	Зарегистрированные модели	Modele zastrzeżone
	Flusso nominale in condizioni reali di lavoro (Tj=85°)	Fluxo nominal baseado em condições reais de trabalho (Tj=85°)	Номинальный поток в реальных рабочих условиях (Tj=85°)	Znamionowy przepływ w rzeczywistych warunkach pracy (Tj=85°)
	Regolatore d'intensità	Com regulador de intensidade	Регулятор яркости	Ściemniacz
	Verificare la disponibilità	Consultar disponibilidade	Проверить наличие	Dostępność
	Efficienza	Eficiência	Эффективность	Skuteczność
	Tensione d'entrata	Tensão de entrada	Напряжение на входе	Napięcie zasilania

	ESPAÑOL	ENGLISH	FRANÇAIS	DEUTSCH
	Intensidad de corriente máxima	Maximum current intensity	Intensité de courant maximale	Maximale Stromstärke
	Amperios	Amperes	Ampères	Ampere
	Corriente continua	Direct current	Courant continu	Wechselstrom
	Corriente alterna	Altern current	Courant alternatif	Altern Strom
	Exterior	Outdoor	Extérieur	Außen
	Interior	Indoor	Intérieur	Innen
	Vida útil	Lamp life	Durée de vie utile	Nutzungsdauer
	Interruptor de encendido	On•off switch	Interrupteur simple allumage	Schalter
	Doble interruptor de encendido	Double on•off switch	Interrupteur double allumage	Doppel Schalter
	Interruptor de encendido en el cable	Cable on•off switch	Interrupteur d'allumage sur le câble	Schalter am Kabel
	Interruptor de cuerda	Pull cord switch	Interrupteur a ficelle	Strickschalter
	Regulador de intensidad	Dimmer	Régulateur d'intensité	Mit dimmer
	Conexión USB	USB port	Connexion USB	USB-Anschluss
	Apto para posición vertical y horizontal	Suitable for vertical and horizontal mounting	Installation en position verticale et horizontale	Senkrecht und waagrecht geeignet
	Orientable	Adjustable	Orientable	Verstellbar
	No orientable	Non adjustable	Non orientable	Nicht verstellbar
	Espejo de aumento x3	Magnifying mirror x3	Miroir grossissant x3	3-fach Vergrößerungsspiegel
	Espejo de aumento x5	Magnifying mirror x5	Miroir grossissant x5	5-fach Vergrößerungsspiegel
	Dirección del halo de luz	Halo light direction	Direction du faisceau lumineux	Halo Lichtrichtung
	Mando a distancia	Remote control	Télécommande	Fernbedienung
	Mando a distancia no incluido	Remote control not included	Télécommande non compris	Fernbedienung nicht inklusive
	Controlador con mando a distancia	Controller with remote control	Contrôleur avec télécommande	Controller mit Fernbedienung
	Mando de pared	Wall Remote Control	Télécommande murale	Wandbedienung
	Mando de pared no incluido	Wall Remote Control not included	Télécommande murale non fournie	Wandbedienung nicht enthalten
	Toma de corriente	Socket	Prise de courant	Stromanschluss
	Velocidades	Speeds	Vitesses	Geschwindigkeiten

	ITALIANO	PORTUGUÊS	РУССКИЙ ЯЗЫК	POLSKI
	Intensità di corrente massima	Intensidade de corrente máxima	Максимальный ток	Maksymalne natężenie prądu
	Ampere	Amperes	Амперы	Amperów
	Corrente continua	Corrente contínua	Постоянный ток	Prąd stały
	Corrente discontinua	Corrente alterna	Переменный ток	Prąd przemienny
	Esterno	Exterior	Для внешнего освещения	Zewnętrzny
	Interno	Interior	Для внутреннего освещения	Wewnętrzny
	Vita utile	Vida útil	Срок службы	Okres eksploatacji
	Interruttore di accensione	Interruptor on•off	Клавишный выключатель	Włącznik
	Doppio interruttore di accensione	Duplo interruptor on•off	Два клавишных выключателя	Włącznik podwójny
	Interruttore d'accensione nel cavo	Cabo com interruptor on-off	Выключатель на проводе	Wyłącznik w przewodzie
	Interruttore di corda	Interruptor de cordão	Веревочный выключатель	Włącznik sznurowy
	Con regolatore d'intensità	Com regulador de intensidade	Регулятор яркости	Ścieniacz
	Connessione USB	Ligação USB	Подключение USB	Zintegrowane złącze USB
	Adatto sia in verticale che in orizzontale	Apto para posição vertical e horizontal	Вертикально-горизонтальное расположение	Montaż poziomy i pionowy
	Orientabile	Orientável	Регулируемый	Regulowane
	Non orientabile	Não orientável	Нерегулируемый	Nieregulowane
	Lente d'ingrandimento x3	Espelho de aumento x3	Зеркало с увеличением x3	Lustro powiększające x3
	Lente d'ingrandimento x5	Espelho de aumento x5	Зеркало с увеличением x5	Lustro powiększające x5
	Direzione del fascio	Direcção do feixe de luz	Направление света	Kierunek łuny światła
	Telecomando	Comando à distância	Пульт управления	Pilot zdalnego sterowania
	Telecomando non incluso	Comando à distância não incluído	Пульт управления не включен	Pilot zdalnego sterowania nie dołączony
	Regolatore con telecomando	Controlador com comando à distância	Контроллер с дистанционным управлением	Kontroler z pilotem zdalnego sterowania
	Comando da parete	Comando de parede	Настенный пульт управления	Sterownik ścienny
	Comando da parete non incluso	Comando de parede não incluído	Настенный пульт управления не включен	Nie zawiera sterownika ściennego
	Presa di corrente	Tomada de corrente	С выходом для проводного подключения	Gniazdo
	velocità	velocidades	скорости	prędkości

	ESPAÑOL	ENGLISH	FRANÇAIS	DEUTSCH
	Motor de corriente continua	Direct current motor.	Moteur à courant continu	Gleichstrommotor
	Revoluciones por minuto	Revolutions per minute	Tours par minute	Umdrehungen pro Minute
	Silencioso	Quiet	Silencieux	Lautlos
	Función inversa	Reverse function	Fonction inverse	Winter-und Sommerbetrieb
	Palas reversibles	Reversible blades	Lames réversibles	Zweifarbige umkehrbare Flügel
	Barras	Downrods	Barres	Stangen
	Fotometría	Photometric Data	Données photométriques	Fotometrie
	Equivalente a	Brighter as	Eclaire comme	Heller wie
	Metros cuadrados iluminados con una unidad del producto	Square meters illuminated by each product unit	Mètres carrés éclairés avec une unité du produit	Mit einer Mengeneinheit beleuchtete Quadratmeter
	Aislamiento de seguridad, a prueba de cortocircuito	Security isolation, short circuit proof	L'isolement de sécurité, preuve courte du circuit	Sicherheit Isolation, kurzschlussfest
	Ángulo de detección	Detection angle	Angle de détection	Ortungswinkel
	Distancia de detección	Detection distance	Distance de détection	Ortungsabstand
	Incluye sensor de movimiento y crepuscular	It includes movement and twilight sensor	Comprend capteur de mouvement et le crépuscule	Es beinhaltet Bewegungs- und Dämmerungssensor
	Permite regular el tiempo de encendido	Allows you to regulate the time for the "on" switch	Permet de régler la durée d'allumage	Regulierung der Einschaltzeit möglich
	Permite regular la sensibilidad del sensor	Allows you to regulate the sensor sensitivity	Permet de régler la sensibilité du capteur	Regulierung der Sensorempfindlichkeit möglich
	Ángulo de la ópticas	Lents angle	Angle des lentilles	Ausstrahlwinkel der Linsen
	Canales	Channels	Canaux	Kanäle
	xx cambios de color	xx changing colors	xx changements de couleur	xx Farben
	Nº de metros máx. de conexión en serie	Max. no. of metres in serial connection	Longueur max. (en mètres) de raccordement en série	Max. Länge in Metern bei Reihenanschluss
	x metros de cable	x meters of cable	x mètre de câble	x Meter langes Kabel
	Reflector direccional	Directional reflector	Réflecteur directionnel	Einbaustrahler
	Disipación activa	Active dissipation	Dissipateur de chaleur intégré	Aktive Wärmeableitung
	Panal de abeja	Honeycomb	Rayon de miel	Honigwabe
	Aletas antideslumbrantes	Anti-glare directional flaps	Ailettes anti-éblouissement	Blendschutzflügel
	Rango de temperatura de trabajo	Range of operating temperature	Plage de température de travail	Bereich der Betriebstemperatur
	Caja para empotrar incluida	Recessed box included	Boîte à encastrer incluse	Einbaubox inklusive
	Doble salida de cable	Double cable output	Double sortie de câble	Zwei Kabelausgänge
	Empotrable para zona peatonal	Downlight for pedestrian crossing	Encastré pour zone piétonnière	Einbauleuchte für Fussgängerübergang
	ATENCIÓN - Esta luminaria puede soportar una carga estática limitada. ES APTA para zonas donde eventualmente circulan vehículos a baja velocidad. NO ES APTA para zonas de paso habitual de vehículos	ATTENTION - This light fixture can withstand a limited static load. SUITABLE for areas with low-speed vehicles. NON SUITABLE for high traffic areas	ATTENTION - Ce luminaire peut supporter une charge statique limitée. IL EST ADAPTÉ aux zones de circulation occasionnelle de véhicules à basse vitesse. IL N'EST PAS ADAPTÉ aux zones de circulation habituelle de véhicules	ACHTUNG - Diese Leuchte kann eine statische Belastung halten. Die Leuchte ist GEEIGNET für eventuell Kriechverkehr-Bereiche. Die Leuchte ist NICHT GEEIGNET für Fahrzeug-Verkehrsbereiche

	ITALIANO	PORTUGUÊS	РУССКИЙ ЯЗЫК	POLSKI
	Motore a corrente continua	Motor de corrente contínua	Мотор постоянного тока	Silnik prądu stałego
	RPM	Rotações por minuto	Вращений в минуту	Obroty na minutę
	Silenzioso	Silencioso	Бесшумно	Cichy
	Funzione inversa	Função inversa	функция обратного движения	Funkcja odwrotna
	Pale reversibili	Palas reversíveis	Двухсторонние сменные лопасти	Obracalne śmigła
	Barre	Barras	балка	poprzeczki
	Fotometria	Fotometria	Фотометрия	Fotometria
	Pari a	Equivalente a	Равняется	Odpowiada
	Metri quadrati illuminati con unità del prodotto	Metros quadrados iluminados com uma unidade do produto	Площадь, освещаемая одним прибором (м кв.)	Metrów kwadratowych oświetlonych jedną jednostką produktu
	Isolamento di sicurezza, a prova di corto circuito	Isolamento de segurança, à prova de curto-circuito	Изоляция безопасности, короткое доказательство замыкания	Izolacja bezpieczeństwo, krótki dowód obwodu
	Angolo di rilevamento	Ângulo de deteção	Угол обнаружения	Kąt wykrywania
	Distanza di rilevamento	Distância de deteção	Дистанция обнаружения	Odległość wykrywania
	Include il movimento e sensore crepuscolare	Ele inclui movimento e crepuscular sensor	Она включает в себя движение и сумерки датчик	To zawiera czujnik ruchu i zmierzchu
	Consente di regolare il tempo di accensione	Permite regular o tempo de acendimento	Позволяет регулировать продолжительность свечения	Pozwala na regulowanie czasu palenia się
	Consente di regolare la sensibilità del sensore	Permite regular a sensibilidade do sensor	Позволяет регулировать чувствительность датчика	Pozwala na regulowanie czułości czujnika
	Angolo delle lenti	Ângulo das lentes	Угол отражения оптической части	Kąt układu optycznego
	Canali	Canais	Каналы	Kanałów
	xx cambi colori	xx mudança de cor	xx вариантов цвета	xx zmiennych kolorów
	Nº massimo di metri di connessione in serie	Nº de metros máximo de ligação em série	Максимальное кол-во метров для подключения в серии	Maksymalna długość w m przy połączeniu szeregowym
	x metri di cavo	x metros de cabo	x метров провода	x metrów przewodu
	Riflettore direzionale	Reflector direccional	Рефлектор направленности света	Reflektor regulowany
	Dissipazione attiva	Dissipação activa	Система охлаждения	Aktywne odprowadzanie ciepła
	Struttura a nido di vespe	Estrutura tipo "favo de mel"	Соты	Płyta o strukturze plastra miodu
	Alette rompiflusso	Alhetas anti-encandeamento	Противослепящие заслонки	Kłapy przeciwośnieniowe
	Livello di temperatura di esercizio	Intervalo de temperatura de funcionamento	Разброс рабочей температуры	Zakres temperatury pracy
	Cassaforma inclusa	Caixa para embutir incluída	Корпус-коробка из технополимера для встраивания прилагается	Puszka montażowa w komplecie
	Cavo a doppia uscita	Dupla saída de cabos	Двойной выход для кабеля	Podwójne gniazdo kabla
	Carrabile per zona pedonale	Encastrável para zona pedonal	Локальный светильник для пешеходной зоны	Downlight na przejścia dla pieszych
	ATTENZIONE- Questa lampada è in grado di sopportare un carico statico limitato. È VALIDO in zone stradali con traffico a bassa velocità. NON È VALIDO per zone stradali con traffico a velocità media	ATENÇÃO - Esta luminária pode suportar uma carga estática limitada. É ADEQUADA para zonas onde, eventualmente, circulem veículos a baixa velocidade. INADEQUADA para zonas de passagem habitual de veículos	ВНИМАНИЕ - Данный светильник выдерживает ограниченное статическое напряжение. ПРИГОДЕН на участках периодического передвижения транспорта на низкой скорости. НЕ ПРИГОДЕН на участках постоянного движения транспортного потока	UWAGA - Ta oprawa może wytrzymać ograniczone nateżenie statyczne. Właściwa dla mało uczęszczanych miejsc. Niewłaściwa dla miejsc o wysokim ruchu kołowym

	ESPAÑOL	ENGLISH	FRANÇAIS	DEUTSCH
	Drenaje	Drainage	Drainage	Dränage
	Estaca de plástico incluida	Plastic spike included	Piquet en plastique inclus	Erdspieß inklusive
	Mantenimiento sin herramientas	Maintenance without tools	Entretien sans outils	Instandhaltung ohne Werkzeuge
	Producto sin barniz. Se puede usar un estropajo abrasivo para el mantenimiento	Non varnished product. An abrasive scourer can be used for maintenance	Produit non verni. Entretien possible uniquement à l'aide de chiffons doux non abrasifs	Artikel nicht lackiert. Zur Pflege kann ein Scheuerschwamm verwendet werden
	Producto barnizado. Usar sólo paños suaves no abrasivos para el mantenimiento	Varnished product. Use non abrasive soft clothes only for maintenance	Produit verni. Utilisez des vêtements non abrasives douces que pour la maintenance	Artikel lackiert. Zur Pflege nur weiche, nicht scheuernde Tücher verwenden
	Cristal de recambio de cortesía	Courtesy spare glass included	Verre de rechange fourni	Zusätzliche Ersatzteile aus Glas zum Auswechseln
	Temperatura en la superficie menor de 40°C	Temperature on the surface under 40°C	Température de surface inférieure à 40°C	Oberflächentemperatur unter 40°C
	Temperatura en la superficie entre 40 y 80°C	Temperature on the surface between 40 and 80°C	Température de surface comprise entre 40 et 80°C	Oberflächentemperatur zwischen 40 und 80°C
	Temperatura en la superficie superior a 80°C	Temperature on the surface over 80°C	Température de surface supérieure à 80°C	Oberflächentemperatur über 80°C
	Filtro Difusor	Difuser Filter	Filtre diffuseur	Filter Diffusor
	Filtro 3000K	3000K Filter	Filtre 3000°K	Filter 3.000° Kelvin
	Fotometría asimétrica	Asymmetrical photometry	Photométrie asymétrique	Asymmetrische Fotometrie
	Fotometría simétrica	Symmetrical photometry	Photométrie symétrique	Symmetrische Fotometrie
	Cumplimiento con las normativas vigentes anticontaminación luminica	According to regulations in force about luminic pollution	Conforme à la réglementation en vigueur contre la pollution lumineuse	Erfüllung der geltenden Vorschriften über Grenzwerte der Lichtverschmutzung
	Luminaria	Luminaire	Luminaire	Leuchte
	Bloque óptico	Optical Assembly	Bloc optique	Optikgehäuse
	Permite instalación LATERAL de ØXmm	LATERAL installation for ØXmm	Permet une installation LATÉRALE de ØX mm	Ermöglicht die Befestigung von oben mit ØXmm
	Permite instalación TOP de ØXmm	TOP installation for ØXmm	Permet une installation SUPÉRIEURE de ØX mm	Ermöglicht die seitliche Befestigung mit ØXmm
	Luminaria certificada por el Instituto de Astrofísica de Canarias	Luminaire certified by the Institute of Astrophysics of Canary Islands	Luminaire certifié par l'Institut d'astrophysique des îles Canaries	Leuchte vom Institut für Astrophysik der Kanarischen Inseln zertifiziert
	Flujo Hemisferio Superior (FHS)	Upper hemisferic luminous flux (light pollution percentage)	Flux lumineux vers l'hémisphère supérieur (FHS)	Oberer hemisphärischer Lichtstrom (Lichtverschmutzung)
	A+... A A+... A A+... B A+... C A+... E	Energy Efficiency	Efficiency énergétique	Energieeffizienz
	Horas de vida	Life (in hours)	Durée de vie en heures	Betriebsstunden
	Luminaria adecuada para instalar en ambientes con atmósfera marina.	Luminaire suitable for installation in environments with marine atmosphere.	Luminaire adapté pour une installation en milieu marin.	Zur Installation in Meeresnähe geeignete Leuchte.
	Lámpara recomendada	Recommended bulb	Ampoule recommandée	Empfohlene lampe
	Driver recomendado	Recommended driver	Driver recommandé	Empfohlener treiber
	Compatible con IN	Compatible with IN	Compatible avec IN	Kompatibel mit IN



	ITALIANO	PORTUGUÊS	РУССКИЙ ЯЗЫК	POLSKI
	Drenaggio	Drenagem	Дренаж	Drenaż
	Picchetto di terra, in plastica, inclusa	Estaca de plástico incluída	Пластиковый шип прилагается	Plastikowy szpikulec w komplecie
	Manutenzione senza attrezzi	Manutenção sem ferramentas	Техническое обслуживание без инструментов	Obsługa beznarzędziowa
	Prodotto senza vernice. Per la manutenzione si può utilizzare uno strofinaccio abrasivo	Produto sem verniz. Para a manutenção, pode-se utilizar um esfregão abrasivo	Продукт без лакировки. Разрешается использование абразивной мочалки для ухода за продуктом	Produkt bez lakierowania. Można użyć ściernego zmywaka dla konserwacji
	Prodotto verniciato. Per la manutenzione utilizzare soltanto panni morbidi e non abrasivi	Produto envernizado. Para a manutenção, utilizar apenas panos macios não abrasivos	Продукт с лакировкой. Использовать только мягкие неабразивные салфетки для ухода за продуктом	Produkt lakierowany. Używać tylko delikatnych, nieścierających ściereczek dla konserwacji
	Vetro di ricambio omaggio	Vidro de substituição incluído	Бесплатно прилагается запасное стекло	Zapasowe szkło w komplecie
	Temperatura alla superficie minore di 40 °C	Temperatura na superfície inferior a 40°C	Температура поверхности менее 40°C	Temperatura powierzchni poniżej 40 °C
	Temperatura alla superficie tra 40 e 80 °C	Temperatura na superfície entre 40 e 80°C	Температура поверхности между 40 и 80°C	Temperatura powierzchni pomiędzy 40 a 80 °C
	Temperatura alla superficie superiore di 80 °C	Temperatura na superfície superior a 80°C	Температура поверхности выше 80°C	Temperatura powierzchni powyżej 80 °C
	Filtro Diffusore	Filtro Difusor	Фильтр Диффузор	Filtr Rozpraszający
	Filtro 3.000K	Filtro 3.000K	Фильтр 3.000K	Filtr 3000K
	Fotometria asimmetrica	Fotometria assimétrica	Асимметричная фотометрия	Fotometria asymetryczna
	Fotometria simmetrica	Fotometria simétrica	Симметричная фотометрия	Fotometria symetryczna
	Rispetta le attuali normative anti-inquinamento luminoso	Cumprimento da legislação em vigor sobre medidas contra a poluição luminosa	Соответствует действующим нормам по борьбе со световым загрязнением	W zgodzie z przepisami dotyczącymi zanieczyszczenia światłem
	Luce	Luminária	Светильник	Oprawa oświetleniowa
	Blocco ottico	Bloco ótico	Оптический блок	Blok optyczny
	Consente installazione LATERALE di ØXmm	Permite instalação LATERAL com Ø de X mm	Позволяет БОКОВУЮ установку ØX мм	Umożliwia montaż pionowy
	Consente installazione SUPERIORE di ØXmm	Permite instalação TOP com Ø de X mm	Позволяет ВЕРХНИЮ установку ØX мм	Umożliwia montaż poziomy
	Luce certificata dall'Istituto di Astrofisica delle Canarie	Luminária certificada pelo Instituto de Astrofisica de Canárias	Светильники, сертифицированные Институтом астрофизики Канарских островов	Oprawa certyfikowana przez instytut astrofizyki wysp kanaryjskich
	Flusso emisfero superiore	Fluxo luminoso emitido acima do plano horizontal (FHS)	Световой поток верхнего полушария	Strumień półprzestrzenny górny (SPG)
	Efficienza Energetica	Eficiência Energética	Энергосбережение	Efektywność energetyczna
	Ore di vita utile	Horas de vida	Срок службы в часах	Żywotność (w godzinach)
	Lampade adatte per essere installate in ambienti marini.	Luminária adequada para instalação em ambientes com atmosfera marinha.	Степень защиты позволяет использование в приморских районах.	Oprawa nadaje się do montażu w środowisku nadmorskim.
	Lampadina raccomandata	Lâmpada recomendada	Рекомендуемая лампа	Zalecana żarówka
	Driver raccomandato	Driver recomendado	Рекомендуемый драйвер	Zalecany sterownik
	Compatibile con IN	Compatível com IN	Продукт, совместимый с IN	Kompatybilny z IN



















	ESPAÑOL	ENGLISH	FRANÇAIS	DEUTSCH
ABS	PLÁSTICO ABS	ABS PLASTIC	PLASTIQUE ABS	SPRITZKUNSTSTOFF ABS
ACR	ACRÍLICO	ACRYLIC	ACRYLIQUE	ACRYL
AL	ALUMINIO	ALUMINIUM	ALUMINIUM	ALUMINIUM
AL ANOD	ALUMINIO ANODIZADO	ANODIZED ALUMINIUM	ALUMINIUM ANODISÉ	ELOXIERTES ALUMINIUM
AL EXTR	ALUMINIO EXTRUSIONADO	EXTRUDED ALUMINIUM	EXTRUDÉ D'ALUMINIUM	EXTRUDIERTES ALUMINIUM
AL INJ	ALUMINIO INYECTADO	INJECTED ALUMINIUM	ALUMINIUM INJECTÉ	SPRITZALUMINIUM
AL PUR	ALUMINIO DE ALTA PUREZA	HIGH PURITY ALUMINUM	ALUMINIUM HAUTE PURETÉ	ALUMINIUM MIT HOHEM REINHEITSGRAD
DM	DM (TABLERO DE FIBRA DE DENSIDAD MEDIA)	MDF (MEDIUM DENSITY FIBREBOARD)	MDF (PANNEAU DE FIBRES À DENSITÉ MOYENNE)	MDF-PLATTE (MITTELDICHTE HOLZFASERPLATTE)
BR	LATÓN PULIDO	POLISH BRASS	LAITON POLI	MESSING POLIERT
COT	ALGODÓN	COTTON	COTON	BAUMWOLLE
FRO	MATIZADO	MATTE	MAT	MATTIERT
GLA	CRISTAL	GLASS	VERRE	GLAS
GLA BEV/SAT	CRISTAL BISELADO Y SATINADO	BEVELED AND SATIN GLASS	VERRE BISEAUTÉ ET SATINÉ	GESCHLIFFENES UND SATINIERTES GLAS
GLA BEV	CRISTAL BISELADO	BEVELED GLASS	VERRE BISEAUTÉ	GESCHLIFFENER GLAS
GLA BU	CRISTAL BURBUJA	BUBBLED GLASS	VERRE À BULLES	BLASENGLAS
GLA HARD	CRISTAL TEMPLADO	HARDENED GLASS	VERRE TREMPÉ	GEHÄRTETES DURCHSICHTIGES GLAS
GLA MAT	CRISTAL MATE	MATT GLASS	VERRE MAT	GLAS MATT
GLA OPAL	CRISTAL OPAL	OPAL GLASS	VERRE OPALIN	OPAL GLAS
GLA RUST	CRISTAL RÚSTICO	RUSTIC GLASS	VERRE RUSTIQUE	RUSTIKALES GLAS
GLA SAT	CRISTAL SATINADO	SATIN GLASS	VERRE SATINÉ	GLAS SATINIERT
GLA SMOKE	CRISTAL AHUMADO	SMOKED GLASS	VERRE FUMÉ	RAUCHGLAS
GLA TRAN	CRISTAL TRANSPARENTE	TRANSPARENT GLASS	VERRE TRANSPARENT	TRANSPARENTES GLAS
HD PE	POLIETILENO DE ALTA DENSIDAD	HIGH DENSITY POLYTHYLENE	POLYÉTHYLÈNE HAUTE DENSITÉ	HOCHDICHTER POLYETHEN
INOX AISI 202	ACERO INOXIDABLE AISI 202	STAINLESS STEEL AISI 202	ACIER INOXYDABLE AISI 202	ROSTFREIER STAHL AISI 202
INOX AISI 304	ACERO INOXIDABLE AISI 304	STAINLESS STEEL AISI 304	ACIER INOXYDABLE AISI 304	ROSTFREIER STAHL AISI 304
INOX AISI 316	ACERO INOXIDABLE AISI 316	STAINLESS STEEL AISI 316	ACIER INOXYDABLE AISI 316	ROSTFREIER STAHL AISI 316
MIR	ESPEJO	MIRROR	MIROIR	SPIEGEL
PC	POLICARBONATO	POLYCARBONATE	POLYCARBONATE	POLYKARBONAT

	ITALIANO	PORTUGUÊS	РУССКИЙ ЯЗЫК	POLSKI
	PLASTICA ABS	PLÁSTICO ABS	ABS ПЛАСТИК	PLASTIK ABS
	ACRILICO	ACRILICO	АКРИЛОВЫЙ	AKRYL
	ALLUMINIO	ALUMINIO	АЛЮМИНИЙ	ALUMINIUM
	ALLUMINIO ANODIZZATO	ALUMINIO ANODIZADO	АНОДИРОВАННЫЙ АЛЮМИНИЙ	ALUMINIUM ANODOWANE
	ESTRUSO DI ALLUMINIO	ALUMÍNIO EXTRUDIDO	ПРЕССОВАННЫЙ АЛЮМИНИЙ	WYCISKANE ALUMINIUM
	ALLUMINIO PRESSOFUSO	ALUMÍNIO INJECTADO	ИНЖЕКТИРОВАННЫЙ АЛЮМИНИЙ	WTRYSKIWANE ALUMINIUM
	ALLUMINIO DI ALTA PUREZZA	ALUMÍNIO DE ELEVADA PUREZA	АЛЮМИНИЙ ВЫСОКОЙ ЧИСТОТЫ	ALUMINIUM WYSOKIEJ CZYSTOŚCI
	MDF (PANNELLO DI FIBRA A MEDIA DENSITÀ)	MDF (PAINEL DE FIBRA DE MADEIRA DE MÉDIA DENSIDADE)	(МДФ) ДРЕВЕСНОВОЛОКНИСТАЯ ПЛИТА СРЕДНЕЙ ПЛОТНОСТИ	PŁYTA MDF (MEDIUM DENSITY FIBREBOARD)
	OTTONE LEVIGATO	LATÃO POLIDO	ПОЛИРОВАННАЯ ЛАТУНЬ	MOSIADZ POLEROWANY
	COTONE	ALGODÃO	ХЛОПОК	BAWEŁNA
	SFUMATO	MATIZADO	ПОЛЯРИЗОВАННЫЙ	MAT
	VETRO	VIDRO	СТЕКЛО	SZKŁO
	VETRO BISELLATO SATINATO	VIDRO SATINADO COM MOLDURA FACETADA	ФАЦЕТИРОВАННОЕ И САТИНИРОВАННОЕ СТЕКЛО	SZKŁO FAZOWANE SATYNOWE
	VETRO BISELLATO	VIDRO COM MOLDURA FACETADA	ФАЦЕТИРОВАННОЕ СТЕКЛО	SZKŁO FAZOWANE
	VETRO BOLLIOSO	VIDRO COM BOLHAS	ПУЗЫРЯЩЕЕСЯ СЕКЛО	SZKŁO Z PĘCHERZYKAMI
	VETRO TEMPERATO	VIDRO ENDURECIDO	ЗАКАЛЁННОЕ СТЕКЛО	SZKŁO HARTOWANE
	VETRO MATIZZATO	VIDRO MATE	МАТОВОЕ СЕКЛО	MATOWE SZKŁO
	VETRO OTTICO	VIDRO OPALINO	МАТОВОЕ СТЕКЛО	SZKŁO MLECZNE
	VETRO RUSTICO	VIDRO RÚSTICO	ГРУБОЕ СТЕКЛО	SZKŁO RUSTYKALNE
	VETRO SATINATO	VIDRO ACETINADO	СТЕКЛО САТИНОВОЕ	SZKŁO SATYNOWE
	VETRO FUMÉ	VIDRO FUMADO	ДЫМЧАТОЕ СТЕКЛО	SZKŁO DYMIONE
	VETRO TRASPARENTE	VIDRO TRANSPARENTE	ПРОЗРАЧНОЕ СТЕКЛО	PRZEZROCZYSTE SZKŁO
	POLIETILENO AD ALTA DENISTA	POLIETILENO DE ALTA DENSIDADE	ПОЛИЭТИЛЕН ВЫСОКОЙ ПЛОТНОСТИ	POLIETYLEN WYSZJIEJ GĘSTOŚCI
	ACCIAIO INOSSIDABILE AISI 202	AÇO INOXIDÁVEL AISI 202	НЕРЖАВЕЮЩАЯ СТАЛЬ AISI 202	STAL NIERDZEWNA AISI 202
	ACCIAIO INOSSIDABILE AISI 304	AÇO INOXIDÁVEL AISI 304	НЕРЖАВЕЮЩАЯ СТАЛЬ AISI 304	STAL NIERDZEWNA AISI 304
	ACCIAIO INOSSIDABILE AISI 316	AÇO INOXIDÁVEL AISI 316	НЕРЖАВЕЮЩАЯ СТАЛЬ	STAL NIERDZEWNA AISI 316
	SPECCHIO	ESPELHO	ЗЕРКАЛО	LUSTRO
	POLICARBONATO	POLICARBONATO	ПОЛИКАРБОНАТ	POLIWEGLANOWY

	ESPAÑOL	ENGLISH	FRANÇAIS	DEUTSCH
PC MAT	POLICARBONATO MATE	MATT POLYCARBONATE	POLYCARBONATE MAT	POLYKARBONAT MATT
PC OPAL	POLICARBONATO OPAL	OPAL POLYCARBONATE	POLYCARBONATE OPALE	POLYKARBONAT OPAL
PC PRISM	POLICARBONATO PRISMATIZADO	PRISMATIC POLYCARBONATE	POLYCARBONATE PRISMATIQUE	POLYKARBONAT PRISMATISIERT
PC TRAN	POLICARBONATO TRANSPARENTE	TRANSPARENT POLYCARBONATE	POLYCARBONATE TRANSPARENT	POLYKARBONAT TRANSPARENT
PE	POLIETILENO	POLYTHYLENE	POLYÉTHYLÈNE	POLYÄTHYLEN
PMMA	PMMA	PMMA	PMMA	PMMA
PMMA MAT	PMMA MATE	MATT PMMA	PMMA MAT	PMMA MATT
PMMA TRANS	PMMA TRANSPARENTE	TRANSPARENT PMMA	PMMA TRANSPARENT	PMMA TRANSPARENT
PMMA OPAL	PMMA OPAL MATE	SATIN OPAL PMMA	PMMA OPALE SATINÉ	PMMA OPAL MATT
PMMA PRISM	PMMA PRISMATIZADO	PRISMATIC PMMA	PMMA PRISMATIQUE	PMMA PRISMATISIERT
PLA COT	ALGODÓN PLASTIFICADO	PLASTICIZED COTTON	COTON PLASTIFIÉ	BAUMWOLLE
PLY	CONTRACHAPADO	PLYWOOD	CONTREPLAQUÉ	SPERRHOLZ
PLASTER	YESO	PLASTER	GYPSE	VERPUTZ
PP	POLIPROPILENO	POLYPROPYLENE	POLYPROPYLÈNE	POLYPROPYLEN
PUR	POLIURETANO	POLYURETHANE	POLYURÉTHANE	POLYURETHAN
PVC	PVC	PVC	PVC	PVC
RES	RESINA	RESIN	RÉSINE	HARZ
SIL	SILICONA	SILICONE	SILICONE	SILIKON
SILK	SEDA	SILK	SOIE	SEIDE
ST	ACERO	STEEL	ACIER	STAHL
ST EPOXY	ACERO ACABADO EPOXY	EPOXY FINISH STEEL	ACIER FINITION ÉPOXY	STAHL, FERTIGVERARBEITUNG MIT EPOXY-LACKIERUNG
TEC POLI	TECNOPLÍMERO	TECHNOPOLYMER	TECHNOPOLYMÈRE	TECHNOPOLYMER
TERMO PLAST	TERMOPLÁSTICO	THERMOPLASTIC	THERMOPLASTIQUE	THERMOPLASTIK
UVA PROTECTION	PROTECCIÓN UVA	UVA PROTECTION	PROTECTION UVA	UV-SCHUTZ
UVA GLA	CRISTAL UVA	UVA GLASS	VERRE U.V.	UV-GLAS
WOOD	MADERA	WOOD	BOIS	HOLZ
ZAM	ZAMAK	ZAMAK	ZAMAK	ZAMAK



























	ITALIANO	PORTUGUÊS	РУССКИЙ ЯЗЫК	POLSKI
	POLICARBONATO MATIZZATO	POLICARBONATO MATE	МАТОВЫЙ ПОЛИКАРБОНАТ	MATOWY POLIWEGLAN
	POLICARBONATO OPALE	POLICARBONATO OPALINO	ОПАЛОВЫЙ ПОЛИКАРБОНАТ	OPALIZOWANY POLIWEGLAN
	POLICARBONATO PRISMATICO	POLICARBONATO PRISMÁTICO	ПРИЗМАТИЧЕСКИЙ ПОЛИКАРБОНАТ	PRYZMATYCZNY POLIWEGLAN
	POLICARBONATO TRASPARENTE	POLICARBONATO TRANSPARENTE	ПРОЗРАЧНЫЙ ПОЛИКАРБОНАТ	PRZEZROCZYSTY POLIWEGLAN
	POLIETILENE	POLIETILENO	ПОЛИЭТИЛЕН	POLIETYLEN
	PMMA	PMMA	PMMA	PMMA
	PMMA MATIZZATO	PMMA MATE	МАТОВЫЙ PMMA	MATOWY PMMA
	PMMA TRASPARENTE	PMMA TRASPARENTE	ПРОЗРАЧНЫЙ PMMA	PRZEZROCZYSTY PMMA
	PMMA OPALE MATIZZATO	PMMA OPALINO SATINADO	РАСSEИВАЮЩЕЕ PMMA ОПАЛОВОЕ	SATYNOWY OPALIZOWANY PMMA
	PMMA PRISMATICO	PMMA PRISMÁTICO	ПРИЗМАТИЧЕСКОЕ СТЕКЛО	PRYZMATYCZNY PMMA
	COTONE PLASTIFICATO	ALGODAO PLASTIFICADO	УПЛОТНЕННЫЙ ХЛОПОК	POWLEKANA BAWĘLNA
	COMPENSATO	CONTRAPLACADO	ФАНЕРА	SKLEJKA
	GESSO	GESSO	ГИПС	GIPS
	POLIPROPILENE	POLIPROPILENO	ПОЛИПРОПИЛЕН	POLIPROPYLEN
	POLIURETANO	POLIURETANO	ПОУЛИРИТАН	POLIURETAN
	PVC	PVC	PVC	PVC
	RESINA	RESINA SINTÉTICA	РЕЗИНА	ŻYWICA
	SILICONE	SILICONE	СИЛИКОН	SILIKON
	SETA	SEDA	ШЕЛК	JEDWAB
	ACCIAIO	AÇO	СТАЛЬ	STAL
	ACCIAIO ALLUMINIO PRESSOFUSO	AÇO COM ACABAMENTO EPOXY	ЭПОКСИДНОЕ ПОКРЫТИЕ СТАЛИ	STAL WYKOŃCZONA EPOKSYDOWO
	TECNOPOLIMERO	TECNOPOLÍMERO	ТЕХНОПОЛИМЕР	TECNOPOLIMER
	TERMOPLASTICA	TERMOPLÁSTICO	ТЕРМОПЛАСТИК	TERMOPLASTYCZNY
	PROTEZIONE RAGGI UVA	PROTEÇÃO UVA	ЗАЩИТА ОТ УФЛ	OCHRONA UVA
	VETRO UVA	VIDRO UVA	СТЕКЛО С ЗАЩИТОЙ ОТ УЛЬТРАФИОЛЕТОВЫХ ЛУЧЕЙ	SZKŁO UVA
	LEGNO	MADEIRA	ДЕРЕВО	DREWNO
	ZAMAK	ZAMAK	ZAMAK	ZAMAK

	ESPAÑOL	ENGLISH	FRANÇAIS	DEUTSCH
	MATERIAL DIFUSOR	DIFFUSER MATERIAL	MATÉRIAU DIFFUSEUR	DIFFUSORMATERIAL
	MATERIAL PANTALLA	SHADE MATERIAL	MATÉRIAU ABAT-JOUR	SCHIRMMATERIAL
	MATERIAL PALAS	BLADES MATERIAL	MATÉRIAU DES PALES	FLÜGELMATERIAL

	ESPAÑOL	ENGLISH	FRANÇAIS	DEUTSCH
	NEGRO	BLACK	NOIR	SCHWARZ
	COBRE	COPPER	CUIVRE	KUPFER
	VERDE	GREEN	VERT	GRÜN
	NARANJA	ORANGE	ORANGE	ORANGE
	AZUL	BLUE	BLEU	BLAU
	MAGENTA	MAGENTA	MAGENTA	MAGENTA (ROSA)
	BLANCO	WHITE	BLANC	WEISS
	ÁMBAR	AMBER	AMBRÉ	BERNSTEINFARBE
	BLANCO ANTIGUO	OLD WHITE	BLANC ANCIEN	ALT WEISS
	MARRÓN ÓXIDO	RUSTY BROWN	MARRON ROUILLE	BRAUNROST
	BRONCE	BRONZE	BRONZE	BRONZE
	BEIGE	BEIGE	BEIGE	BEIGE
	CROMO	CHROME	CHROME	CHROM
	LATÓN PULIDO	POLISH BRASS	LAITON POLI	MESSING POLIERT
	DORADO	GOLDEN	DORÉ	GOLDEN
	AMARILLO	YELLOW	JAUNE	GELB (GELB/GRÜN)
	ROJO	RED	ROUGE	ROT
	GRIS	GREY	GRIS	GRAU
	TRANSPARENTE	TRANSPARENT	TRANSPARENT	DURCHSICHTIG

	ITALIANO	PORTUGUÊS	РУССКИЙ ЯЗЫК	POLSKI
	MATERIALE DEL DIFFUSORE	MATERIAL DIFUSOR	МАТЕРИАЛ РАССЕИВАТЕЛЯ	MATERIAŁ ROZPRASZAJĄCY
	MATERIALE DEL PARALUME	MATERIAL ABAT-JOUR	МАТЕРИАЛ АБАЖУРА	MATERIAŁ ABAŻURU
	MATERIALE DELLE PALE	MATERIAL PÁS	МАТЕРИАЛ ЛОПАСТИ	MATERIAŁ ŚMIGŁA

	ITALIANO	PORTUGUÊS	РУССКИЙ ЯЗЫК	POLSKI
	NERO	PRETO	ЧЕРНЫЙ	CZARNY
	RAME	COBRE	МЕДЬ	MIEDZIANY
	VERT	VERDE	ЗЕЛЕНый	ZIELONY
	ARANCIONE	LARANJA	ОРАНЖЕВый	POMARAŃCZOWY
	BLU	AZUL	СИНИЙ	NIEBIESKI
	MAGENTA	MAGENTA (ROSA)	МАДЖЕНТА	MAGENTA
	BIANCO	BRANCO BRILHANTE	БЕЛый	BIAŁY
	AMBRA	ÂMBAR	ЯНТАРный	BURSZTYN
	BIANCO ANTICHIZZATO	BRANCO VELHO	СТАРИНный БЕЛый	STARY BIAŁY
	MARRONE OSSIDATO	CASTANHO OXIDADO	РЖАВО-КОРИЧНЕВый	RDZAWY BRĄZ
	BRONZO	BRONZE	БРОНЗА	BRĄZ
	BEIGE	BEGE	БЕЖЕВый	BEZ
	CROMO	CROMO	ХРОМ	CHROMOWANY
	OTTONE LEVIGATO	LATÃO POLIDO	ПОЛИРОВАНная ЛАТУНЬ	MOSIĄDZ POLEROWANY
	ORO	DOURADO	ПОЗОЛОЧЕНный	ZŁOTY
	GIALLO	AMARELO	ЛАЙМ	CYTRYNOWY
	ROSSO	VERMELHO	КРАСНый	CZERWONY
	GRIGIO	CINZENTO	СЕРый	SZARY
	TRASPARENTE	TRANSPARENTE	ПРОЗРАЧный	PRZEZROCZYSTE

	ESPAÑOL	ENGLISH	FRANÇAIS	DEUTSCH
 48	ACERO CINCADO	ZINC PLATED STEEL	ACIER ZINGUÉ	VERZINKTER STAHL
 53	ANODIZADO GRANATE	GRANATE ADONISED	ANODISÉ GRENAT	GRANATROT ELOXIERT
 54 BK J2	ALUMINIO ANODIZADO	ANODIZED ALUMINIUM	ALUMINIUM ANODISÉ	ALUMINIUM ELOXIERT
 93	MADERA CLARA	LIGHT WOOD	BOIS BLOND	HELLES HOLZ
 94	ANODIZADO ORO	GOLD ANODIZING	ANODISÉ OR	ELOXAL-SCHICHT GOLD
 81 NS	NÍQUEL SATINADO	SATIN NICKEL	NICKEL SATINÉ	NICKEL SATINIERT
 AF	ALUMINO SATINADO	SATIN ALUMINIUM	ALUMINIUM SATINÉ	ALUMINIUM, SATINIERT
 AL AW	ALUMINIO	ALUMINIUM	ALUMINIUM	ALUMINIUM
 AV	ACERO GALVANIZADO	GALVANISED STEEL	ACIER GALVANISÉ	GALVANISIERTES STAHL
 AS	NEGRO BRILLANTE / BLANCO BRILLANTE / CROMO	SHINY BLACK / SHINY WHITE / CHROME	NOIR BRILLANT / BLANC BRILLANT / CHROME	SCHWARZ GLÄNZEND / WEISS GLÄNZEND / CHROM
 BB	CABEZAL EN GRIS (AU) + COLUMNA EN NEGRO (BP)	HEAD IN GREY (AU) + COLUMN IN BLACK (BP)	TÊTE EN GRIS (AU) + MÂT EN NOIR (BP)	KOPFSTÜCK IN GRAU (AU) + SÄULE IN SCHWARZ (BP)
 BP	NEGRO (PINTURA EN POLVO)	BLACK (POWDER PAINT)	NOIR (PEINTURE EN POUDRE)	SCHWARZ (PULVERLACK)
 BS	GRIS RAL 9007	GREY RAL 9007	GRIS RAL 9007	GRAU RAL 9007
 BX S2	ALUMINIO CEPILLADO	BRUSHED ALUMINIUM	ALUMINIUM BROSSÉ	ALUMINIUM GEBÜRSTET
 BY	ARENA	BEIGE FABRIC	BEIGE	SANDFARBE
 CA	ACERO INOXIDABLE AISI 316	STAINLESS STEEL AISI 316	ACIER INOXYDABLE AISI 316	ROSTFREIER STAHL AISI 316
 CC	GRIS ENVEJECIDO	OLD GREY	GRIS VIEILLI	ALT GRAU
 CF	BLANCO BRILLANTE	BRIGHT WHITE	BLANC BRILLANT	WEISS GLÄNZEND
 CI	MARRÓN	BROWN	MARRON	BRAUN
 CS	GRIS CEMENTO	CEMENT GREY	GRIS CIMENT	ZEMENTGRAU
 CY	BRONCE OXIDADO	DARK ANTIQUE BRONZE	BRONZE OXYDÉ	BRONZE OXIDIERT
 E2	ORO VIEJO	OLD GOLD	OR VIEILLI	ALTGOLD
 E4	PATINÉ	ANTIQUÉ BRASS	PATINÉ	ALTMESSING
 F5	ORO PINTADO	PAINTED GOLD	OR PEINT	GOLDFARBEN LACKIERT
 J6	MARRÓN	BROWN	MARRON	BRAUN
 J7	MARRÓN COBRIZO	COPPER BROWN	MARRON CUIVRÉ	KUPFERROT BRAUN
 K7	GRIS PIEDRA	STONE GREY	GRIS PIERRE	STEINGRAU

	ITALIANO	PORTUGUÊS	РУССКИЙ ЯЗЫК	POLSKI
	ACCIAIO ZINCATO	AÇO ZINCADO	ОЦИНКОВАННАЯ СТАЛЬ	OCYNKOWANA STAL
	ANODIZZATO BORDEAUX	ANODIZADO GRENÁ	ANODOWANE CIEMNO CZERWONE	МЕТАЛЛИК ГРАНАТОВЫЙ
	ALLUMINIO ANODIZZATO	ALUMINIO ANODIZADO	АНОДИРОВАННЫЙ АЛЮМИНИЙ	ALUMINIUM ANODOWANE
	LEGNO CHIARO	MADEIRA CLARA	СВЕТЛОЕ ДЕРЕВО	JASNE DREWNO
	ANODIZZATO ORO	ANODIZADO OURO	АНОДИРОВАННЫЙ ЗОЛОТИСТЫЙ	ANODOWANE ZŁOTO
	NÍCHEL SATINATO	NÍQUEL ACETINADO	САТИНОВЫЙ НИКЕЛЬ	SZCZOTKOWANY NIKIEL
	ALLUMINIO SATINATO	ALUMÍNIO ACETINADO	АЛЮМИНИЯ САТИН	ALUMINIUM SATYNOWY
	ALLUMINIO	ALUMINIO	АЛЮМИНИЙ	ALUMINIUM
	ACCIAIO GALVANIZZATO	AÇO GALVANIZADO	ОЦИНКОВАННАЯ СТАЛЬ	STAL GALWANIZOWANA
	NERO BRILLANTE / BIANCO BRILLANTE / CROMO	PRETO BRILHANTE / BRANCO BRILHANTE / CROMO	ЧЕРНЫЙ БЛЕСТЯЩИЙ / БЕЛЫЙ БЛЕСТЯЩИЙ / ХРОМ	LSNIACY CZARNY/LSNIACY BIAŁY/CHROMOWANY
	TESTATA IN GRIGIO (AU) + COLONNA IN NERO	CABEÇAL EM CINZENTO (AU) + COLUNA EM PRETO (BP)	ГОЛОВКА СЕРОГО ЦВЕТА (AU) + КОЛОННА ЧЕРНОГО ЦВЕТА (BP)	GŁOWICA W SZAROŚCI (AU) + SŁUP W CZERNI (BP)
	NERO (VERNICE IN POLVERE)	PRETO (PINTURA EM PÓ)	ЧЕРНЫЙ (ПОРОШКОВАЯ КРАСКА)	CZARNY (FARBA PROSZKOWA)
	GRIGIO RAL 9007	CINZENTO RAL 9007	СЕРЫЙ RAL 9007	SZARY RAL 9007
	ALLUMINIO SPAZZOLATO	ALUMÍNIO ESCOVADO	МАТОВЫЙ АЛЮМИНИЙ	SZCZOTKOWANE ALUMINIUM
	SABBIA	AREIA	ПЕСОЧНЫЙ	BEZ
	ACCIAIO INOSSIDABILE AISI 316	AÇO INOXIDÁVEL AISI 316	НЕРЖАВЕЮЩАЯ СТАЛЬ	STAL NIERDZEWNA AISI 316
	GRIGIO ANTICO	CINZA ENVELHECIDO	СЕРЫЙ АНТИЧНЫЙ	STARY SZARY
	BIANCO LUCIDO	BRANCO BRILLANTE	БЕЛЫЙ БЛЕСТЯЩИЙ	JASNY BIAŁY
	MARRONE	CASTANHO	КОРИЧНЕВЫЙ	BRAZOWY
	GRIGIO CEMENTO	CINZA CIMENTO	СЕРЫЙ ЦЕМЕНТНЫЙ	W KOLORZE SZAREGO CEMENTU
	BRONZO ANTICO SCURO	BRONZE OXIDADO	СОСТАРЕННАЯ БРОНЗА	POSTARZANY BRAZ
	ORO ANTICO	OURO VELHO	СТАРОЕ ЗОЛОТО	STARE ZŁOTO
	PATINATO	PATINÉ	ПАТИНЕ	MOSIĄDZ ANTYCZNY
	ORO VERNICIATO	OURO PINTADO	ОКРАСКА ПОД ПОЗОЛОТУ	MALOWANE ZŁOTO
	MARRONE	CASTANHO	КОРИЧНЕВЫЙ	BRAZOWY
	MARRONE COLOR RAME	CASTANHO ACOBREADO	КОРИЧНЕВАЯ МЕДЬ	MIEDZIOWY BRAZ
	GRIGIO PIETRA	CINZENTO PEDRA	СЕРЫЙ КАМЕНЬ	SZARY KAMIEŃ

	ESPAÑOL	ENGLISH	FRANÇAIS	DEUTSCH
 T001	TRAMADO BEIGE	PERFORATED BEIGE	PERFORÉ BEIGE	GEWIRKT BEIGE
 T4	PLATA RÚSTICA	RUSTIC SILVER	ARGENT RUSTIQUE	RUSTIKALES SILBER
 V7	COBRE VIEJO	OLD COPPER	CUIVRE VIEUX	ALTES KUPFER
 X8	ANODIZADO BRONCE	ANODIZED BRONZE	BRONZE ANODISÉ	ELOXIERT BRONZE
 Y2	MARRÓN ENVEJECIDO	OLD BROWN	MARRON VIEILLI	ALTBRAUN
 Y4	ACERO INOXIDABLE AISI 202/304	STAINLESS STEEL AISI 202/304	ACIER INOXYDABLE AISI 202/304	ROSTFREIER STAHL AISI 202/304
 Z5 BQ	GRIS URBANO	URBAN GREY	GRIS URBAIN	ANTHRAZIT

	ITALIANO	PORTUGUÊS	РУССКИЙ ЯЗЫК	POLSKI
	TRAMATURA BEIGE	PERFURADO BEGE	БЕЖЕВЫЙ СЕТИ	BEŻOWY PERFOROWANY
	ARGENTO RUSTICO	PRATA RÚSTICA	НЕОБРАБОТАННОЕ СЕРЕБРО	RUSTYKALNE SREBRO
	RAME ANTICATO	COBRE VELHO	СТАРАЯ МЕДЬ	STARA MIEDZ
	ANODIZZATO BRONZO	ANODIZADO BRONZE	АНОДИРОВАННЫЙ БРОНЗА	BRAZ ANODOWANE
	MARRONE ANTICHIZZATO	CASTANHO ENVELHECIDO	БРАУН АНТИК	STARY BRAZOWY
	ACCIAIO INOSSIDABILE AISI 202/304	AÇO INOXIDÁVEL AISI 202/304	НЕРЖАВЕЮЩАЯ СТАЛЬ AISI 202/304	STAL NIERDZEWNA AISI 202/304
	GRIGIO URBANO	CINZENTO URBANO	ГОРОДСКОЙ СЕРЫЙ	SZARY MIEJSKI

Reference	Page
00-0073-05-23	240
00-0073-14-05	240
00-0240-21-16	227
00-0240-21-Z5	227
00-0253-21-16	226
00-0253-S4-CC	226
00-0264-21-82	246
00-0268-21-82	246
00-1640-81-F9	381
00-1799-21-16	388
00-1799-S4-CG	388
00-2011-21-16	388
00-2011-S4-CG	388
00-2017-14-14	218
00-2017-CS-CS	218
00-2018-14-F9	380
00-2018-21-F9	380
00-2287-14-14	218
00-2287-CS-CS	218
00-2708-16-11	390
00-2708-CG-16	390
00-2709-16-11	390
00-2709-CG-16	390
00-2710-16-11	390
00-2710-CG-16	390
00-2713-81-AJ	396
00-2749-E2-16	392
00-2749-T4-11	392
00-2785-21-AS	397
00-2908-E2-16	392
00-2908-T4-11	392
00-3219-S2-M2	374
00-3251-14-M1	222
00-3272-S2-37	376
00-3279-05-05	377
00-3279-16-16	377
00-3280-05-05	378
00-3280-05-16	378
00-3280-16-16	378
00-4037-14-37	372
00-4037-CS-12	372
00-4339-21-05	250
00-4341-Z6-20	258
00-4426-14-14	244
00-4835-14-14	220
00-4836-14-14	220
00-4850-E4-15	386
00-4850-E4-37	386
00-4851-E4-19	386
00-4925-34-M1	214
00-4925-F5-M1	214
00-4926-34-M1	214
00-4926-F5-M1	214
00-4929-94-M1	382
00-4930-94-M1	382

Reference	Page
00-4941-14-00	177
00-4942-14-M2	177
00-4943-14-B9	177
00-4944-14-00	177
00-4945-14-M2	177
00-4946-14-B9	177
00-4947-14-00	177
00-4948-14-M2	177
00-4949-14-B9	177
00-4950-14-00	177
00-4951-14-M2	177
00-4952-14-B9	177
00-4953-14-00	177
00-4954-14-M2	177
00-4955-14-B9	177
00-4956-14-00	180
00-4957-14-M2	180
00-4958-14-B9	180
00-4959-14-00	180
00-4960-14-M2	180
00-4961-14-B9	180
00-4962-14-00	181
00-4963-14-M2	181
00-4964-14-B9	181
00-5297-14-23	384
00-5297-Z5-23	384
00-5346-F5-F5	366
00-5348-14-14	366
00-5350-34-34	366
00-5362-14-23	242
00-5362-14-34	242
00-5425-CI-20	254
00-5434-60-11	368
00-5435-60-13	368
00-5436-60-24	368
00-5437-60-E7	369
00-5438-60-E7	369
00-5439-60-E7	371
00-5440-60-E7	371
00-5441-60-E7	370
00-5442-60-E7	370
00-5443-60-E7	370
00-5448-CI-08	224
00-5449-CI-15	224
00-5450-CI-18	224
00-5451-CI-E7	224
00-5456-05-23	238
00-5456-14-05	238
00-5463-53-M3	212
00-5478-05-05	236
00-5478-14-14	236
00-5479-05-05	234
00-5479-14-14	234
00-5480-05-CY	237
00-5480-05-F5	237

Reference	Page
00-5480-14-34	237
00-5480-14-CY	237
00-9151-18-E7	670
00-9155-14-M1	659
00-9156-14-M1	659
00-9298-14-M1	662
00-9298-Z5-M3	662
00-9350-18-AA	666
00-9669-14-M1	656
00-9796-14-M1	660
00-9866-18-M3	668
05-0026-21-F9	425
05-0027-21-F9	425
05-0028-21-F9	425
05-0070-14-14	324
05-0070-S2-14	324
05-0071-14-14	315
05-0072-34-34	300
05-0517-21-E9	334
05-0518-21-E9	334
05-0519-21-E9	334
05-0534-14-14	324
05-0848-16-21	338
05-0849-16-21	338
05-0850-16-21	338
05-1380-21-F9	427
05-1383-21-F9	427
05-1389-21-F9	427
05-1410-21-F9	427
05-1411-21-F9	426
05-1507-21-M1	422
05-1508-21-M1	422
05-1513-21-21	340
05-1514-21-21	340
05-1530-21-05	310
05-1530-21-14	310
05-1531-21-05	310
05-1531-21-14	310
05-1544-54-H6	515
05-1546-54-H6	515
05-1547-54-H6	515
05-1548-54-H6	515
05-1549-54-H6	515
05-1552-54-H6	515
05-1555-34-34	297
05-1567-81-82	284
05-1577-21-M2	312
05-1577-81-M2	312
05-1577-E4-M2	312
05-1611-21-M2	312
05-1611-81-M2	312
05-1611-E4-M2	312
05-1760-21-E9	334
05-1793-14-14	322
05-1794-14-14	323

Reference	Page
05-1795-14-14	322
05-1796-14-14	322
05-1798-14-14V1	323
05-1804-14-00	191
05-1808-14-00	191
05-2015-14-14	296
05-2015-34-34	296
05-2017-14-14	218
05-2019-14-14	324
05-2019-S2-14	324
05-2233-14-14	348
05-2325-21-M1	420
05-2326-21-M1	420
05-2327-21-M1	422
05-2328-21-M1	422
05-2494-54-H6	505
05-2498-54-H6	505
05-2499-54-H6	505
05-2510-Z6-82	266
05-2703-14-14V1	326
05-2703-21-21V1	326
05-2703-81-81V1	326
05-2704-14-14V1	326
05-2704-21-21V1	326
05-2704-81-81V1	326
05-2705-14-14V1	326
05-2705-21-21V1	326
05-2705-81-81V1	326
05-2706-21-21	301
05-2706-81-81	301
05-2706-E4-E4	301
05-2707-81-21	394
05-2753-14-M2	307
05-2755-81-21	268
05-2756-81-21	268
05-2757-14-82	282
05-2758-14-82	282
05-2759-14-05	240
05-2814-81-05	294
05-2814-81-14	294
05-2814-81-20	294
05-2815-81-81	270
05-2817-81-14	252
05-2820-21-21	270
05-2820-81-81	270
05-2830-34-34	305
05-2831-34-34	305
05-2835-54-54	305
05-2837-21-21	304
05-2838-21-21	304
05-2840-21-82	288
05-2845-21-21	304
05-2897-21-M2	312
05-2897-81-M2	312
05-2897-E4-M2	312

Reference	Page
05-2904-14-00	191
05-3213-21-B4	432
05-3217-19-82	272
05-3217-21-82	272
05-3217-81-82	272
05-3217-E4-82	272
05-3218-19-82	272
05-3218-21-82	272
05-3218-81-82	272
05-3218-E4-82	272
05-3220-14-14	314
05-3220-25-25	314
05-3220-34-34	314
05-3251-14-M1	222
05-3308-S2-00	187
05-3314-N3-B9	187
05-3358-N3-37	502
05-3980-14-14	316
05-3980-S2-14	316
05-4339-21-05	251
05-4341-Z6-20	258
05-4351-21-37	339
05-4352-21-37	339
05-4357-21-M1	419
05-4358-21-M1	419
05-4361-21-05	417
05-4362-21-05	417
05-4363-81-20	289
05-4373-21-F9	429
05-4374-21-M1	420
05-4375-21-M1	420
05-4376-21-M1	420
05-4377-21-M1	422
05-4378-21-M1	422
05-4379-81-F9	426
05-4385-21-M1	424
05-4386-21-M1	424
05-4387-21-M1	424
05-4401-14-B8	328
05-4401-BX-B8	328
05-4402-BX-B8	329
05-4695-81-82	274
05-4695-Y2-82	274
05-4696-81-82	274
05-4696-Y2-82	274
05-4699-21-M1	416
05-4700-21-M1	416
05-4755-CI-23	232
05-4760-21-05	308
05-4760-E4-Y2	308
05-4901-19-E4	292
05-4919-21-82	278
05-4920-21-82	278
05-4921-06-14	350
05-4921-21-14	350

Reference	Page
05-4925-34-M1	216
05-4925-F5-M1	216
05-4931-93-93	320
05-4968-06-14	350
05-4968-21-14	350
05-5048-93-93	320
05-5296-81-81	302
05-5306-14-06	342
05-5306-14-21	342
05-5306-CI-06	342
05-5306-CI-21	342
05-5307-14-06	342
05-5307-14-21	342
05-5307-CI-06	342
05-5307-CI-21	342
05-5308-21-M1	414
05-5309-21-M1	414
05-5315-14-14	298
05-5315-21-21	298
05-5315-81-81	298
05-5330-14-14	318
05-5330-S2-14	318
05-5361-14-23	242
05-5361-14-34	242
05-5425-CI-20	254
05-5427-CI-20	254
05-5447-81-14	290
05-5463-53-M3	212
05-5478-05-05	236
05-5478-14-14	236
05-8729-05-M3	556
05-8729-34-M3	556
05-8751-05-M3	556
05-8751-34-M3	556
05-8762-18-37	674
05-8790-Y4-M1	560
05-8796-Y4-M1	560
05-8959-05-37	672
05-8961-05-B8	582
05-8961-14-B8	582
05-8961-34-B8	582
05-9104-18-M2	672
05-9107-34-37	510
05-9107-Z5-37	510
05-9122-Y4-37	510
05-9123-34-B8	538
05-9123-Z5-B8	538
05-9131-34-M3	538
05-9131-Z5-M3	538
05-9149-18-AA	674
05-9151-18-E7	670
05-9175-18-AA	674
05-9177-14-B8	329, 534
05-9177-34-B8	534
05-9177-J6-B8	534

Reference	Page
05-9177-Z5-B8	534
05-9179-14-B8	578
05-9179-34-B8	578
05-9179-Z5-B8	578
05-9190-34-37	546
05-9191-34-37	546
05-9202-18-AA	675
05-9204-34-B8	536
05-9207-Y4-M1	560
05-9211-CA-T2	582
05-9212-CA-T2	582
05-9228-14-37	522
05-9228-34-37	522
05-9228-Z5-37	522
05-9229-14-37	522
05-9229-34-37	522
05-9229-Z5-37	522
05-9230-14-37	522
05-9230-34-37	522
05-9230-J6-37	522
05-9230-Z5-37	522
05-9234-18-37	538
05-9234-34-37	538
05-9238-34-M3	558
05-9239-CA-M2	561
05-9245-CA-37V1	502, 644
05-9254-34-37	516
05-9266-Z5-37	514
05-9296-Z5-37	508
05-9298-14-M1	663
05-9298-Z5-M3	663
05-9299-Z5-M3	662
05-9310-CA-37	510
05-9330-05-B8	672
05-9344-J6-T2	548
05-9350-18-AA	667
05-9351-18-AA	667
05-9368-14-37	524
05-9368-34-37	524
05-9368-Z5-37	524
05-9369-34-37	526
05-9369-Z5-37	526
05-9390-Z5-M3	662
05-9408-34-M3	540
05-9408-Z5-M3	540
05-9416-34-37	500
05-9416-Z5-37	500
05-9434-34-T2	578
05-9438-34-37	522
05-9438-Z5-37	522
05-9439-Z5-37	514
05-9444-Z5-CD	554
05-9457-34-M3	540
05-9457-Z5-M3	540
05-9474-34-37	499

Reference	Page
05-9483-34-CL	548
05-9484-34-CL	548
05-9501-34-37	499
05-9502-34-37	499
05-9537-34-37	516
05-9538-34-37	516
05-9539-34-37	516
05-9544-Z5-M3	557
05-9559-34-B8	542
05-9565-Z5-B8	544
05-9566-Z5-B8	544
05-9577-34-37	526
05-9577-Z5-37	526
05-9592-34-37	531
05-9592-34-CL	531
05-9593-14-CM	532
05-9593-34-37	532
05-9594-14-37	532
05-9594-34-37	532
05-9596-34-37	585
05-9596-34-CL	585
05-9598-34-M2	506
05-9605-Z5-M1	558
05-9626-34-CL	498
05-9626-34-CM	498
05-9629-CA-B8	534
05-9640-05-37	511
05-9640-14-37	511
05-9640-34-37	511
05-9649-14-T2	534
05-9649-34-T2	534
05-9649-J6-T2	534
05-9649-Z5-T2	534
05-9650-34-T2	539
05-9652-34-M2	506
05-9662-34-CD	540
05-9677-14-M1	555
05-9679-34-B8	532
05-9679-Z5-B8	532
05-9683-14-CLV1	528
05-9683-Z5-CLV1	528
05-9684-14-CLV1	528
05-9684-Z5-CLV1	528
05-9685-14-CL	546
05-9685-Z5-T2	546
05-9686-Z5-M1	554
05-9687-14-M1	548
05-9719-34-37	536
05-9719-Z5-CM	536
05-9722-05-37	500
05-9722-14-37	500
05-9725-34-T2	524
05-9725-Z5-T2	524
05-9726-Z5-37	552
05-9727-05-CMV1	644

Reference	Page
05-9728-05-CMV1	644
05-9731-34-CL	497
05-9731-34-CM	497
05-9732-34-CMV1	528
05-9732-Z5-CMV1	528
05-9734-14-M1	542
05-9734-34-M1	542
05-9735-34-M1	538
05-9739-05-37	506
05-9749-54-37	513
05-9749-54-CL	513
05-9750-54-37	513
05-9750-54-CL	513
05-9751-34-CLV1	516
05-9751-34-CMV1	516
05-9753-CA-CLV1	535
05-9757-CA-CL	580
05-9758-34-37	584
05-9770-34-M2	580
05-9771-34-M2	580
05-9772-34-M2	580
05-9773-34-37V1	524
05-9773-Z5-37V1	524
05-9774-CC-CD	661
05-9779-34-CLV2	552
05-9779-34-CMV2	552
05-9780-34-M1	559
05-9787-Z5-CLV1	496
05-9787-Z5-CMV1	496
05-9788-Z5-CL	496
05-9788-Z5-CM	496
05-9789-34-37	508
05-9789-Z5-37	508
05-9790-34-CL	536
05-9790-Z5-CL	536
05-9799-CA-CM	584
05-9800-14-CL	535
05-9800-34-CL	535
05-9800-J6-CL	535
05-9800-Z5-CL	535
05-9802-14-CMV1	550
05-9813-34-CL	496
05-9813-34-CM	496
05-9814-14-CMV1	550
05-9830-34-37	498
05-9831-34-37	498
05-9832-34-CM	578
05-9832-Z5-CM	578
05-9833-05-CL	584
05-9833-05-CM	584
05-9836-14-CL	544
05-9836-34-CL	544
05-9837-14-CL	544
05-9837-34-CL	544
05-9838-14-CLV1	552

Reference	Page
05-9838-14-CMV1	552
05-9841-05-CL	506
05-9849-34-CL	498
05-9849-34-CM	498
05-9850-34-CL	498
05-9850-34-CM	498
05-9851-Z5-CLV1	496
05-9851-Z5-CMV1	496
05-9852-Z5-CLV1	496
05-9852-Z5-CMV1	496
05-9853-Z5-CL	496
05-9853-Z5-CM	496
05-9854-Z5-CL	496
05-9854-Z5-CM	496
05-9856-34-CL	497
05-9856-34-CM	497
05-9858-34-CL	496
05-9858-34-CM	496
05-9859-34-37	498
05-9860-34-37	498
05-9861-34-37	498
05-9862-34-37	498
05-9866-18-M3	669
05-9868-CC-B8	673
05-9870-34-CL	506
05-9870-Z5-CL	506
05-9871-Z5-37	546
05-9872-Z5-CL	558
05-9873-Z5-CLV1	530
05-9878-14-CL	520
05-9878-Z5-CL	520
05-9879-14-CL	520
05-9879-Z5-CL	520
05-9881-X8-CM	501
05-9884-14-G5	542
05-9884-Z5-G5	542
05-9885-34-CM	578
05-9885-Z5-CM	578
05-9886-34-M1	557
05-9889-CA-CM	502, 644
05-9894-14-CL	530
05-9894-Z5-CL	530
05-9896-Z5-CL	507
05-9905-CA-CL	535
05-9911-14-CL	520
05-9911-Z5-CL	520
05-9912-14-CL	520
05-9912-Z5-CL	520
05-9916-54-CL	513
05-9916-54-CM	513
10-1523-21-21	399
10-1530-21-05	400
10-1530-21-14	400
10-1531-21-05	400
10-1531-21-14	400

Reference	Page
10-1567-81-82	284
10-1568-81-82	286
10-2757-14-82	282
10-2817-81-14	252
10-2825-21-82	280
10-3273-21-05	402
10-3273-E4-Y2	402
10-4339-21-05	250
10-4341-Z6-20	258
10-4369-Z6-82	266
10-4695-21-82	274
10-4695-81-82	274
10-4755-CI-23	233
10-4757-06-F9	398
10-4757-81-F9	398
10-4759-81-82	269
10-4919-21-82	279
10-4925-34-M1	216
10-4925-F5-M1	216
10-5425-CI-20	256
10-5448-CI-08	225
10-5449-CI-15	225
10-5450-CI-18	225
10-8790-Y4-M1	626
10-9151-18-E7	670
10-9298-Z5-M3	664
10-9299-14-M1	665
10-9299-Z5-M3	665
10-9350-18-AA	666
10-9386-34-M3	628
10-9386-K7-M3	628
10-9386-Z5-M3	628
10-9387-34-M3	628
10-9387-K7-M3	628
10-9387-Z5-M3	628
10-9390-Z5-M3	664
10-9645-Z5-M2	606
10-9774-CC-CD	661
10-9847-Z5-CL	607
10-9866-18-M3	668
10-9874-M1-M1	654
10-9903-34-CM	527
127-NS	406
15-0073-05-23	241
15-0073-14-05	241
15-0074-14-05	240
15-1521-21-E9	364
15-1522-21-E9	364
15-1733-81-F9V1	435
15-2020-14-14	348
15-2021-14-14	348
15-2514-21-F9	436
15-2905-34-M1	362
15-2906-S2-M1	358
15-2907-S2-M1	359

Reference	Page
15-2936-S2-M1V1	359
15-2937-S2-M1V1	359
15-2938-S2-M1V1	359
15-2939-S2-M1V1	358
15-2940-S2-M1V1	358
15-3213-21-B4	432
15-3214-21-B4	432
15-4336-14-M1	365
15-4341-Z6-20	258
15-4370-21-F9	434
15-4426-14-14	244
15-4682-21-E9	364
15-4684-21-E9	364
15-4685-14-M1	360
15-4686-14-M1	360
15-4687-14-M1	360
15-4688-14-M1	360
15-4695-20-M1	356
15-4695-J6-M1	356
15-4696-20-M1	356
15-4696-J6-M1	356
15-4797-14-OS	165
15-4797-14-OU	165
15-4797-N3-OS	165
15-4797-N3-OU	165
15-4798-14-OS	165
15-4798-14-OU	165
15-4798-N3-OS	165
15-4798-N3-OU	165
15-4849-14-14	352
15-4849-34-34	352
15-4849-F5-F5	352
15-4860-14-M1	125
15-4861-14-M1	125
15-4921-06-14	350
15-4921-21-14	350
15-4922-BY-M1	354
15-4924-BY-M1	354
15-4968-06-14	350
15-4968-21-14	350
15-4969-14-14	352
15-4969-34-34	352
15-4969-F5-F5	352
15-5058-14-M1	125
15-5059-14-M1	125
15-5062-S2-M1V1	359
15-5063-S2-M1V1	359
15-5064-S2-M1V1	359
15-5067-S2-M1V1	358
15-5068-S2-M1V1	358
15-5069-14-14	348
15-5073-14-14	348
15-5206-14-M1	123
15-5207-14-M1	123
15-5264-14-00	107

Reference	Page
15-5264-60-00	107
15-5265-14-00	107
15-5265-60-00	107
15-5266-14-00	107
15-5266-60-00	107
15-5267-14-00	107
15-5267-60-00	107
15-5268-14-00	107
15-5268-60-00	107
15-5269-14-00	107
15-5269-60-00	107
15-5270-14-00	107
15-5270-60-00	107
15-5271-14-00	107
15-5271-60-00	107
15-5298-21-M1	430
15-5299-21-M1	430
15-5428-14-M1	123
15-5431-14-M1	123
15-5432-14-M1	123
15-5433-14-M1	123
15-5468-14-OS	165
15-5468-14-OU	165
15-5468-N3-OS	165
15-5468-N3-OU	165
15-5469-14-OS	165
15-5469-14-OU	165
15-5469-N3-OS	165
15-5469-N3-OU	165
15-5470-14-OS	165
15-5470-14-OU	165
15-5470-N3-OS	165
15-5470-N3-OU	165
15-5471-14-OS	165
15-5471-14-OU	165
15-5471-N3-OS	165
15-5471-N3-OU	165
15-9234-34-37	568
15-9298-Z5-M3	662
15-9328-34-B8	562
15-9328-Z5-B8	562
15-9350-18-AA	666
15-9362-34-37	568
15-9362-Z5-37	568
15-9365-34-T2	568
15-9365-Z5-T2	568
15-9392-Y4-B8	574
15-9480-34-37	562
15-9480-Z5-37	562
15-9491-34-M3	570
15-9493-34-M3	570
15-9542-34-M3	570
15-9558-CA-B8	562
15-9561-34-37	564
15-9562-34-37	576

Reference	Page
15-9563-34-37	576
15-9619-34-M1	566
15-9665-CA-CLV1	574
15-9665-CA-CMV1	574
15-9677-14-M1	572
15-9678-14-M1	572
15-9680-34-37	562
15-9688-34-M1	554
15-9708-CA-37	576
15-9778-34-CLV1	566
15-9790-34-CL	568
15-9790-Z5-CL	568
15-9806-34-CL	566
15-9807-34-M1	566
15-9810-05-CL	572
15-9810-05-CM	572
15-9835-34-M1	556, 571
15-9839-05-CL	563
15-9900-34-CM	564
15-9901-34-CM	564
170-NS	276
172-NS	276
174-NS	277
176-NS	277
20-2012-Z6-82	267
20-2013-Z6-82	267
20-2510-Z6-82	266
20-4755-CI-23	230
20-4756-CI-23	230
248-NS	405
25-0240-21-16	228
25-0240-21-Z5	228
25-0467-21-82	248
25-1523-21-21	399
25-1567-81-82	285
25-1568-81-82	286
25-2510-Z6-82	267
25-2757-14-82	283
25-2817-81-14	252
25-2825-21-82	280
25-2860-Y2-05	411
25-2860-Y2-14	411
25-3215-14-M1	407
25-3216-14-M3	408
25-3273-21-05	402
25-3273-E4-Y2	402
25-4339-21-05	250
25-4341-Z6-20	258
25-4695-21-82	275
25-4695-81-82	275
25-4755-CI-23	233
25-4759-81-82	269
25-4760-21-05	404
25-4919-21-82	279
25-4925-34-M1	217

Reference	Page
25-4925-F5-M1	217
25-5425-CI-20	257
25-9503-14-M1	654
25-9503-Z5-M1	654
25-9614-14-M1	652
25-9642-14-M1	652
25-9733-05-M1	650
274-NS	335
280-NS	313
284-CR	330
30-0068-14-F9	476
30-0068-81-F9	476
30-1854-CF-F9	484
30-1964-CF-CF	492
30-1964-N3-N3	492
30-1965-81-E9	472
30-2854-81-F9	474
30-3248-16-E9	462
30-3248-CG-E9	462
30-3249-CF-M1	454, 456
30-3250-CF-M1V1	458
30-4354-81-M1	480
30-4355-81-M1	466
30-4355-CF-M1	466
30-4356-CF-CF	490
30-4357-81-82	478
30-4393-CF-M1	468
30-4393-N3-M1	468
30-4398-J7-J7	482
30-4399-14-F9	470
30-4399-81-F9	470
30-4399-E4-F9	470
30-4405-J7-E7	485
30-4863-81-81	488
30-4863-CF-CF	488
30-4864-16-F9	460
30-4865-N3-F9	464
30-4866-81-81	488
30-4866-CF-CF	488
30-5377-81-81	486
30-5378-14-F9	452
320-BL	87, 440
320-CR	87, 440
320-NS	87, 440
331-GR	363
332-GR	362
337-AL	410
35-1557-14-00	75
35-1557-60-00	75
35-1558-14-00	75
35-1558-60-00	75
35-1559-14-00	75
35-1559-60-00	75
35-1565-14-00	75
35-1565-60-00	75

Reference	Page
35-2200-14-DU	63
35-2200-14-OS	63
35-2200-14-OU	63
35-2200-60-DU	63
35-2200-60-OS	63
35-2200-60-OU	63
35-2202-14-DU	63
35-2202-14-OS	63
35-2202-14-OU	63
35-2202-60-DU	63
35-2202-60-OS	63
35-2202-60-OU	63
35-2204-14-DU	63
35-2204-14-OS	63
35-2204-14-OU	63
35-2204-60-DU	63
35-2204-60-OS	63
35-2204-60-OU	63
35-2205-14-DU	63
35-2205-14-OS	63
35-2205-14-OU	63
35-2205-60-DU	63
35-2205-60-OS	63
35-2205-60-OU	63
35-2210-14-OS	63
35-2210-14-OU	63
35-2210-60-OS	63
35-2210-60-OU	63
35-2215-14-OS	63
35-2215-14-OU	63
35-2215-60-OS	63
35-2215-60-OU	63
35-2512-14-OS	64
35-2512-60-OS	64
35-2513-14-OS	64
35-2513-60-OS	64
35-2515-14-OS	64
35-2515-60-OS	64
35-2517-14-OS	64
35-2517-60-OS	64
35-2898-14-00	75
35-2898-60-00	75
35-3510-14-DU	63
35-3510-14-OS	63
35-3510-14-OU	63
35-3510-60-DU	63
35-3510-60-OS	63
35-3510-60-OU	63
35-3511-14-DU	63
35-3511-14-OS	63
35-3511-14-OU	63
35-3511-60-DU	63
35-3511-60-OS	63
35-3511-60-OU	63
35-3553-14-00	49

Reference	Page
35-3554-14-00	49
35-3555-14-37	49
35-3556-14-37	49
35-3557-14-37	49
35-3558-14-37	49
35-3559-14-37	49
35-3560-14-37	49
35-3561-14-DU	49
35-3561-14-OS	49
35-3561-14-OU	49
35-3562-14-DU	49
35-3562-14-OS	49
35-3562-14-OU	49
35-3563-14-DU	49
35-3563-14-OS	49
35-3563-14-OU	49
35-3564-14-DU	49
35-3564-14-OS	49
35-3564-14-OU	49
35-3565-14-DU	49
35-3565-14-OS	49
35-3565-14-OU	49
35-3566-14-DU	49
35-3566-14-OS	49
35-3566-14-OU	49
35-3567-14-DU	49
35-3567-14-OS	49
35-3567-14-OU	49
35-3568-14-DU	49
35-3568-14-OS	49
35-3568-14-OU	49
35-3569-14-DU	49
35-3569-14-OS	49
35-3569-14-OU	49
35-3570-14-OU	49
35-3571-14-OU	49
35-3572-14-OU	49
35-3573-14-OU	49
35-3574-14-OU	49
35-3575-14-OU	49
35-3581-14-00	51
35-3582-14-00	51
35-3583-14-37	51
35-3584-14-37	51
35-3585-14-37	51
35-3586-14-37	51
35-3587-14-37	51
35-3588-14-37	51
35-3589-14-OS	51
35-3589-14-OU	51
35-3590-14-OS	51
35-3590-14-OU	51
35-3591-14-OS	51
35-3591-14-OU	51
35-3592-14-OS	51

Reference	Page
35-3592-14-OU	51
35-3593-14-OS	51
35-3593-14-OU	51
35-3594-14-OS	51
35-3594-14-OU	51
35-3595-14-OS	51
35-3595-14-OU	51
35-3596-14-OS	51
35-3596-14-OU	51
35-3597-14-OS	51
35-3597-14-OU	51
35-3598-14-OU	51
35-3599-14-OU	51
35-3600-14-OU	51
35-3601-14-OU	51
35-3602-14-OU	51
35-3603-14-OU	51
35-3611-14-00	53
35-3612-14-00	53
35-3613-14-37	53
35-3614-14-37	53
35-3616-14-37	53
35-3617-14-37	53
35-3618-14-37	53
35-3619-14-37	53
35-3621-14-OS	53
35-3621-14-OU	53
35-3622-14-OS	53
35-3622-14-OU	53
35-3623-14-OS	53
35-3623-14-OU	53
35-3624-14-OS	53
35-3624-14-OU	53
35-3625-14-OS	53
35-3625-14-OU	53
35-3626-14-OS	53
35-3626-14-OU	53
35-3628-14-OS	53
35-3628-14-OU	53
35-3629-14-OS	53
35-3629-14-OU	53
35-3630-14-OS	53
35-3630-14-OU	53
35-3631-14-OU	53
35-3632-14-OU	53
35-3633-14-OU	53
35-3634-14-OU	53
35-3635-14-OU	53
35-3636-14-OU	53
35-3908-14-OU	63
35-3908-60-OU	63
35-3909-14-OU	63
35-3909-60-OU	63
35-3910-14-OU	63
35-3910-60-OU	63

Reference	Page
35-3911-14-OU	63
35-3911-60-OU	63
35-3912-14-OU	63
35-3912-60-OU	63
35-3913-14-OU	63
35-3913-60-OU	63
35-3931-14-OS	63
35-3931-14-OU	63
35-3931-60-OS	63
35-3931-60-OU	63
35-3932-14-OS	63
35-3932-14-OU	63
35-3932-60-OS	63
35-3932-60-OU	63
35-3933-14-OS	63
35-3933-14-OU	63
35-3933-60-OS	63
35-3933-60-OU	63
35-3934-14-DU	73
35-3934-14-OS	73
35-3934-14-OU	73
35-3934-60-DU	73
35-3934-60-OS	73
35-3934-60-OU	73
35-3935-14-DU	73
35-3935-14-OS	73
35-3935-14-OU	73
35-3935-60-DU	73
35-3935-60-OS	73
35-3935-60-OU	73
35-3936-14-DU	73
35-3936-14-OS	73
35-3936-14-OU	73
35-3936-60-DU	73
35-3936-60-OS	73
35-3936-60-OU	73
35-3937-14-DU	73
35-3937-14-OS	73
35-3937-14-OU	73
35-3937-60-DU	73
35-3937-60-OS	73
35-3937-60-OU	73
35-3938-14-DU	73
35-3938-14-OS	73
35-3938-14-OU	73
35-3938-60-DU	73
35-3938-60-OS	73
35-3938-60-OU	73
35-3939-14-DU	73
35-3939-14-OS	73
35-3939-14-OU	73
35-3939-60-DU	73
35-3939-60-OS	73
35-3939-60-OU	73
35-3940-14-DU	73

Reference	Page
35-3940-14-OS	73
35-3940-14-OU	73
35-3940-60-DU	73
35-3940-60-OS	73
35-3940-60-OU	73
35-3941-14-DU	73
35-3941-14-OS	73
35-3941-14-OU	73
35-3941-60-DU	73
35-3941-60-OS	73
35-3941-60-OU	73
35-3942-14-DU	73
35-3942-14-OS	73
35-3942-14-OU	73
35-3942-60-DU	73
35-3942-60-OS	73
35-3942-60-OU	73
35-3943-14-OU	73
35-3943-60-OU	73
35-3944-14-OU	73
35-3944-60-OU	73
35-3945-14-OU	73
35-3945-60-OU	73
35-3946-14-OU	73
35-3946-60-OU	73
35-3947-14-OU	73
35-3947-60-OU	73
35-3948-14-OU	73
35-3948-60-OU	73
35-3949-14-OU	73
35-3949-60-OU	73
35-3950-14-OU	73
35-3950-60-OU	73
35-3951-14-OU	73
35-3951-60-OU	73
35-3952-14-OU	49
35-3953-14-OU	49
35-3954-14-OU	49
35-3955-14-OU	49
35-3956-14-OU	49
35-3957-14-OU	49
35-3958-14-OU	49
35-3959-14-OU	49
35-3960-14-OU	49
35-3961-14-OU	51
35-3962-14-OU	51
35-3963-14-OU	51
35-3964-14-OU	51
35-3965-14-OU	51
35-3966-14-OU	51
35-3967-14-OU	51
35-3968-14-OU	51
35-3969-14-OU	51
35-3970-14-OU	53
35-3971-14-OU	53

Reference	Page	Reference	Page	Reference	Page	Reference	Page
35-3972-14-OU	53	35-5239-14-OS	71	35-5260-60-OU	70	35-5400-60-OS	47
35-3973-14-OU	53	35-5239-14-OU	71	35-5261-14-OU	70	35-5400-60-OU	47
35-3974-14-OU	53	35-5239-60-OS	71	35-5261-60-OU	70	35-5401-14-DU	47
35-3975-14-OU	53	35-5239-60-OU	71	35-5262-14-OU	70	35-5401-14-OS	47
35-3976-14-OU	53	35-5240-14-OS	71	35-5262-60-OU	70	35-5401-14-OU	47
35-3977-14-OU	53	35-5240-14-OU	71	35-5263-14-OU	70	35-5401-60-DU	47
35-3978-14-OU	53	35-5240-60-OS	71	35-5263-60-OU	70	35-5401-60-OS	47
35-4305-14-DU	67	35-5240-60-OU	71	35-5273-14-OU	70	35-5401-60-OU	47
35-4305-14-OS	67	35-5241-14-OS	71	35-5273-60-OU	70	35-5411-14-DU	47
35-4305-14-OU	67	35-5241-14-OU	71	35-5337-14-DF	61	35-5411-14-OS	47
35-4305-60-DU	67	35-5241-60-OS	71	35-5337-14-DG	61	35-5411-14-OU	47
35-4305-60-OS	67	35-5241-60-OU	71	35-5337-14-DM	61	35-5411-60-DU	47
35-4305-60-OU	67	35-5242-14-OS	71	35-5337-14-OF	61	35-5411-60-OS	47
35-4306-14-DU	67	35-5242-14-OU	71	35-5337-14-OG	61	35-5411-60-OU	47
35-4306-14-OS	67	35-5242-60-OS	71	35-5337-14-OM	61	35-5412-14-DU	47
35-4306-14-OU	67	35-5242-60-OU	71	35-5337-60-DF	61	35-5412-14-OS	47
35-4306-60-DU	67	35-5243-14-OS	71	35-5337-60-DG	61	35-5412-14-OU	47
35-4306-60-OS	67	35-5243-14-OU	71	35-5337-60-DM	61	35-5412-60-DU	47
35-4306-60-OU	67	35-5243-60-OS	71	35-5337-60-OF	61	35-5412-60-OS	47
35-4313-14-DU	67	35-5243-60-OU	71	35-5337-60-OG	61	35-5412-60-OU	47
35-4313-14-OS	67	35-5244-14-OS	71	35-5337-60-OM	61	35-5413-14-DU	47
35-4313-14-OU	67	35-5244-14-OU	71	35-5380-14-OS	47	35-5413-14-OS	47
35-4313-60-DU	67	35-5244-60-OS	71	35-5380-14-OU	47	35-5413-14-OU	47
35-4313-60-OS	67	35-5244-60-OU	71	35-5380-60-OS	47	35-5413-60-DU	47
35-4313-60-OU	67	35-5245-14-OS	71	35-5380-60-OU	47	35-5413-60-OS	47
35-4731-14-OU	67	35-5245-14-OU	71	35-5381-14-OS	47	35-5413-60-OU	47
35-4731-60-OU	67	35-5245-60-OS	71	35-5381-14-OU	47	35-5414-14-DU	47
35-4732-14-OU	67	35-5245-60-OU	71	35-5381-60-OS	47	35-5414-14-OS	47
35-4732-60-OU	67	35-5246-14-OU	71	35-5381-60-OU	47	35-5414-14-OU	47
35-4733-14-OU	67	35-5246-60-OU	71	35-5382-14-OS	47	35-5414-60-DU	47
35-4733-60-OU	67	35-5247-14-OU	71	35-5382-14-OU	47	35-5414-60-OS	47
35-4934-14-OS	45	35-5247-60-OU	71	35-5382-60-OS	47	35-5414-60-OU	47
35-4934-60-OS	45	35-5248-14-OU	71	35-5382-60-OU	47	35-5415-14-DU	47
35-4935-14-OS	45	35-5248-60-OU	71	35-5394-14-OS	47	35-5415-14-OS	47
35-4935-60-OS	45	35-5249-14-OU	71	35-5394-14-OU	47	35-5415-14-OU	47
35-4936-14-OS	45	35-5249-60-OU	71	35-5394-60-OS	47	35-5415-60-DU	47
35-4936-60-OS	45	35-5250-14-OU	71	35-5394-60-OU	47	35-5415-60-OS	47
35-4937-14-OS	45	35-5250-60-OU	71	35-5396-14-OS	47	35-5415-60-OU	47
35-4937-60-OS	45	35-5251-14-OU	71	35-5396-14-OU	47	35-5416-14-DU	47
35-4938-14-OS	45	35-5251-60-OU	71	35-5396-60-OS	47	35-5416-14-OS	47
35-4938-60-OS	45	35-5252-14-OU	71	35-5396-60-OU	47	35-5416-14-OU	47
35-4939-14-OS	45	35-5252-60-OU	71	35-5397-14-OS	47	35-5416-60-DU	47
35-4939-60-OS	45	35-5253-14-OU	71	35-5397-14-OU	47	35-5416-60-OS	47
35-5150-14-OU	73	35-5253-60-OU	71	35-5397-60-OS	47	35-5416-60-OU	47
35-5150-60-OU	73	35-5254-14-OU	71	35-5397-60-OU	47	35-5417-14-DU	47
35-5153-14-OU	63	35-5254-60-OU	71	35-5398-14-OS	47	35-5417-14-OS	47
35-5153-60-OU	63	35-5255-14-OU	70	35-5398-14-OU	47	35-5417-14-OU	47
35-5237-14-OS	71	35-5255-60-OU	70	35-5398-60-OS	47	35-5417-60-DU	47
35-5237-14-OU	71	35-5257-14-OU	70	35-5398-60-OU	47	35-5417-60-OS	47
35-5237-60-OS	71	35-5257-60-OU	70	35-5399-14-OS	47	35-5417-60-OU	47
35-5237-60-OU	71	35-5258-14-OU	70	35-5399-14-OU	47	35-5418-14-DU	47
35-5238-14-OS	71	35-5258-60-OU	70	35-5399-60-OS	47	35-5418-14-OS	47
35-5238-14-OU	71	35-5259-14-OU	70	35-5399-60-OU	47	35-5418-14-OU	47
35-5238-60-OS	71	35-5259-60-OU	70	35-5400-14-OS	47	35-5418-60-DU	47
35-5238-60-OU	71	35-5260-14-OU	70	35-5400-14-OU	47	35-5418-60-OS	47

Reference	Page
35-5418-60-OU	47
410-CR	346
415-CR	346
416-CR	347
425-ES	446
426-ES	446
427-ES	446
434-AL	358
443-AL	333
444-BL	337
445-BL	337
446-NS	306
457-CR	421
476-CR	444
479-CR	336
482-CR	336
486-BL	428
487-BL	428
488-AL	418
489-AL	418
492-CR	331
493-CR	331
505-NS	335
506-CR	335
510-CR	332
514-GR	365
55-1573-14-00	189
55-1573-N3-00	189
55-1574-14-00	189
55-1574-N3-00	189
55-8784-05-05	508
55-8790-Y4-M1	626
55-9151-18-18	671
55-9155-M1-M1	658
55-9156-M1-M1	658
55-9184-Y4-37	600
55-9186-CA-37	601
55-9186-Y4-37	601
55-9187-CA-37	596
55-9187-Y4-37	596
55-9190-34-37	622
55-9191-34-37	510
55-9238-34-M3	624
55-9239-CA-M2	627
55-9245-CA-37V1	648
55-9255-54-37	601
55-9264-Y4-37	588
55-9265-Y4-37	588
55-9266-Y4-37	588
55-9268-34-M2	632
55-9269-34-M2	632
55-9280-CA-37	598
55-9280-Y4-37	598
55-9281-CA-37	600
55-9282-CA-CMV1	603

Reference	Page
55-9298-Z5-M3	664
55-9305-48-48	634, 636, 642
55-9317-Y4-M2	626
55-9318-Z5-M3	615
55-9319-Z5-M3	614
55-9320-Z5-M3	614
55-9323-CA-37	596
55-9334-Z5-M3	616
55-9335-Z5-M3	616
55-9336-Z5-M3	616
55-9337-CA-37	600
55-9342-Z5-M3	614
55-9343-Z5-M3	614
55-9350-18-AA	666
55-9358-34-M3	617
55-9358-Z5-M3	617
55-9380-CA-37	598
55-9390-14-M1	664
55-9390-Z5-M3	664
55-9421-M3-M3	600
55-9422-34-M3V1	605
55-9423-34-M3V1	605
55-9424-34-M3V1	605
55-9426-34-M3	604
55-9427-34-T2	604
55-9428-34-T2	604
55-9431-34-M2	632
55-9433-Y4-37	597
55-9440-CA-M2	627
55-9459-Z5-M3	612
55-9479-34-M2	612
55-9481-M1-M1	658
55-9486-CA-37	597
55-9488-34-M3	628
55-9488-Z5-M3	628
55-9504-Z5-M2	608
55-9523-Y4-CL	587
55-9523-Y4-CM	587
55-9527-Y4-CL	587
55-9527-Y4-CM	587
55-9530-34-M2	612
55-9549-34-M3	628
55-9549-Z5-M3	628
55-9550-Z5-M2	608
55-9551-Z5-M2	609
55-9552-Z5-M2	609
55-9555-34-CL	625
55-9557-Z5-CL	620
55-9567-Z5-37	598
55-9605-Z5-M1	624
55-9606-Z5-M1	624
55-9620-54-CL	603
55-9620-54-T2	603
55-9621-54-CL	603
55-9621-54-T2	603

Reference	Page
55-9622-14-CMV1	648
55-9625-CA-37	596
55-9635-CA-37	598
55-9655-05-CD	618
55-9656-05-CD	618
55-9663-CA-CLV1	590
55-9663-CA-CMV1	590
55-9665-CA-37	590
55-9665-CA-CL	590
55-9667-CA-CLV1	590
55-9667-CA-CMV1	590
55-9669-14-M1	656
55-9682-Z5-37	622
55-9690-34-M2	629
55-9697-14-M3	646
55-9699-14-M3	646
55-9701-Z5-M3	508
55-9706-Z5-CLV1	610
55-9721-Z5-M1	620
55-9723-CA-37	590
55-9723-CA-CL	590
55-9733-05-M1	650
55-9737-CA-37	600
55-9741-Z5-37	606
55-9768-54-T2	602
55-9769-54-T2	602
55-9775-Z5-CD	621
55-9791-Z5-CL	608
55-9792-CA-CM	648
55-9794-CA-CL	602
55-9795-CA-CL	602
55-9796-M1-M1	660
55-9818-14-M3	646
55-9819-14-M3	646
55-9820-CA-37	593
55-9821-CA-37	593
55-9822-CA-37	592
55-9823-CA-37	592
55-9824-CA-37	592
55-9825-CA-37	592
55-9826-Y4-37	586
55-9827-Y4-37	586
55-9828-Y4-37	586
55-9829-Y4-37	586
55-9834-34-CL	610
55-9848-05-M1	618
55-9864-CA-CL	584
55-9866-18-18	668
55-9867-J6-CL	622
55-9872-Z5-CL	620
55-9873-Z5-CL	624
55-9880-Z5-M1	657
55-9883-Z5-CL	606
55-9890-Z5-CL	610
55-9906-CA-CL	594

Reference	Page
55-9906-CA-CM	594
55-9907-CA-CL	594
55-9907-CA-CM	594
55-9908-CA-CL	595
55-9908-CA-CM	595
55-9909-CA-CL	594
55-9909-CA-CM	594
55-9910-CA-CL	595
55-9910-CA-CM	595
60-9151-18-E7	671
60-9152-18-E7	671
60-9482-Z5-M2	642
60-9809-34-CL	630
60-9809-34-CM	630
60-9842-34-CM	636
60-9866-18-M3	668
60-9913-Z5-CM	643
71-0017-00-00	697
71-0019-00-00	696
71-0038-00-00	690
71-0039-00-00	690
71-0063-00-00	690
71-0064-00-00	690
71-0065-00-00	690
71-0066-00-00	690
71-0289-54-00	206
71-0299-54-00	207
71-0331-54-00	207
71-0388-54-00	208
71-0558-54-00	123, 125
71-0566-54-M2	206
71-0566-54-M3	206
71-0580-54-M2	207
71-0580-54-M3	207
71-0593-54-M2	207
71-0593-54-M3	207
71-0594-54-M2	208
71-0594-54-M3	208
71-0727-00-00	697
71-1553-00-00	697
71-1554-54-00	208
71-1653-34-34	297
71-1843-81-81	699
71-1843-CF-CF	699
71-1844-81-81	699
71-1844-CF-CF	699
71-1849-14-00	58
71-1881-00-00	94, 95
71-1929-14-00	58
71-1930-14-37	58
71-1931-14-37	58
71-1932-14-37	58
71-1964-CF-CF	492
71-1964-N3-N3	492
71-2232-14-14	77, 699

Reference	Page
71-2232-60-60	77, 699
71-2241-00-00	699
71-2337-14-00	56, 57
71-2338-14-00	56, 57
71-2339-14-00	56, 57
71-2340-14-00	56, 57
71-2413-00-00	689
71-2477-00-00	691
71-2675-60-00	63, 64
71-2909-14-37V1	101, 105, 111
71-2909-14-OE	113
71-2910-14-00	110
71-2910-AF-00	110
71-2911-14-00	110
71-2911-AF-00	110
71-2912-14-00	110
71-2912-AF-00	110
71-2913-14-00	110
71-2914-14-00	110
71-2914-AF-00	110
71-2915-14-00	110
71-2915-21-00	110
71-2915-AF-00	110
71-2918-00-00	127
71-2942-14-00	142
71-2942-60-00	142
71-2942-N3-00	142
71-2943-14-00	142
71-2943-60-00	142
71-2943-N3-00	142
71-2944-14-00	142
71-2944-60-00	142
71-2944-N3-00	142
71-2945-14-00	142
71-2945-60-00	142
71-2946-14-00	142
71-2946-60-00	142
71-2947-14-00	142
71-2947-60-00	142
71-2948-14-00	140
71-2948-60-00	140
71-2948-N3-00	140
71-2949-14-00	140
71-2949-60-00	140
71-2949-N3-00	140
71-2950-14-00	140
71-2950-60-00	140
71-2950-N3-00	140
71-2951-14-00	140
71-2951-60-00	140
71-2952-14-00	140
71-2952-60-00	140
71-2953-14-00	140
71-2953-60-00	140
71-2954-00-00	141, 142

Reference	Page
71-2955-00-00	141
71-2956-00-00	141
71-2963-00-37	141
71-2964-00-37	141
71-2971-00-37	141
71-2972-00-37	141
71-2973-00-37	141
71-2974-00-37	141
71-2975-00-37	141
71-2976-00-37	141
71-3212-00-00	142
71-3223-14-00	151
71-3223-60-00	151
71-3224-00-37	141
71-3225-14-37	101, 105, 111
71-3226-14-37V1	101, 105, 111
71-3226-14-OE	113
71-3283-00-00	100, 104, 107, 110
71-3284-00-00	100, 104, 107, 110
71-3411-56-56	197
71-3454-54-M2	206
71-3454-54-M3	206
71-3467-00-00	203
71-3468-00-00	203
71-3473-00-00	697
71-3475-00-00	689
71-3476-00-00	689
71-3479-00-00	690
71-3493-00-00	696
71-3515-00-37	141
71-3516-00-37	141
71-3517-00-37	141
71-3518-00-37	141
71-3519-00-37	141
71-3520-00-37	141
71-3531-60-00	151, 180, 181
71-3542-00-00	688
71-3816-14-M2	115
71-3817-14-M2	115
71-3818-00-00	114, 115
71-3819-14-00	114
71-3819-AF-00	114
71-3820-14-00	114
71-3820-AF-00	114
71-3821-14-00	114
71-3821-AF-00	114
71-3822-14-00	114
71-3822-AF-00	114
71-3823-14-00	114
71-3823-AF-00	114
71-3824-14-00	114
71-3824-AF-00	114
71-3878-14-37	101, 105, 111
71-3881-14-37	101, 105, 111

Reference	Page
71-3882-14-37	101, 105, 111
71-3885-14-M2	83
71-3886-14-M2	83
71-3887-00-00	83
71-3888-00-00	83
71-3896-60-00	73
71-3897-60-00	73
71-3922-00-00	688
71-3923-00-00	688
71-4030-14-37	101, 105, 111
71-4030-14-OE	113
71-4031-14-37	101, 105, 111
71-4031-14-OE	113
71-4032-14-M2	83
71-4033-14-M2	83
71-4038-00-00	690
71-4393-CF-CF	468
71-4393-N3-N3	468
71-4396-00-00	87, 88, 89, 438, 440, 442
71-4398-J7-F9	482
71-4399-14-14	699
71-4520-48-48	630, 638, 640, 642
71-4524-48-48	638, 640, 642
71-4525-48-48	630
71-4531-48-48	630, 638, 640, 642
71-4554-AV-AV	634, 636
71-4661-N3-N3	187
71-4695-81-81	354, 356
71-4706-00-00	689
71-4707-00-00	689
71-4708-00-00	689
71-4722-N3-00	123
71-4723-N3-00	123
71-4741-00-37	141
71-4742-00-37	141
71-4743-00-37	141
71-4744-00-37	141
71-4745-00-37	141
71-4746-00-37	141
71-4751-14-00	100
71-4751-23-00	100
71-4751-60-00	100
71-4752-14-00V1	100, 107
71-4752-23-00V1	100, 107
71-4752-60-00V1	100, 107
71-4753-14-00V1	100
71-4753-23-00V1	100
71-4753-60-00V1	100
71-4754-60-00	104, 110
71-4807-00-00	688
71-4813-00-00	688
71-4816-00-00	688

Reference	Page
71-4834-14-00	165
71-4834-N3-00	165
71-4867-11-11	456
71-4867-13-13	456
71-4867-24-24	456
71-4890-00-00	688
71-4891-00-00	688
71-4892-00-00	688
71-4894-00-00	688
71-4896-00-00	688
71-4897-00-00	688
71-4899-00-00	689
71-4911-N3-00	165
71-4923-00-00	165, 209
71-4928-00-00	689
71-4932-00-00	699
71-4933-00-00	699
71-5086-14-M2	83
71-5087-14-M2	83
71-5123-14-00	104
71-5123-23-00	104
71-5123-60-00	104
71-5124-14-00	104
71-5124-23-00	104
71-5124-60-00	104
71-5125-14-00	104
71-5125-23-00	104
71-5125-60-00	104
71-5126-14-00	100
71-5128-14-00	104
71-5130-14-37	101, 105, 111
71-5131-14-37	101, 105, 111
71-5137-14-00	110
71-5137-21-00	110
71-5137-AF-00	110
71-5138-14-00	110
71-5138-21-00	110
71-5138-AF-00	110
71-5156-14-M2	83
71-5157-14-M2	83
71-5158-14-37	101, 105, 111
71-5158-14-OE	113
71-5159-14-37	101, 105, 111
71-5159-14-OE	113
71-5165-14-37	101, 105, 111
71-5166-60-00	100, 104, 110
71-5167-00-00	100, 104, 110
71-5174-14-14	107
71-5174-60-60	107
71-5175-14-14	107
71-5175-60-60	107
71-5201-60-00	71
71-5202-60-00	71
71-5204-60-00	70

Reference	Page
71-5205-60-00	70, 71
71-5208-00-00	100, 104, 107, 110
71-5210-14-00	76
71-5210-60-00	76
71-5211-14-00	76
71-5211-60-00	76
71-5213-14-00	76
71-5213-60-00	76
71-5214-14-00	77
71-5214-60-00	77
71-5215-14-00	77
71-5215-60-00	77
71-5216-14-00	77
71-5216-60-00	77
71-5217-14-00	77
71-5217-60-00	77
71-5218-14-00	77
71-5218-60-00	77
71-5219-14-00	77
71-5219-60-00	77
71-5220-14-00	77
71-5220-60-00	77
71-5221-14-00	77
71-5221-60-00	77
71-5222-14-00	77
71-5222-60-00	77
71-5223-14-00	77
71-5223-60-00	77
71-5224-14-00	77
71-5224-60-00	77
71-5225-14-00	76
71-5225-60-00	76
71-5226-21-00	76
71-5227-14-00	77
71-5227-60-00	77
71-5228-14-00	77
71-5228-60-00	77
71-5229-14-00	77
71-5229-60-00	77
71-5230-14-00	77
71-5230-60-00	77
71-5231-14-00	77
71-5231-60-00	77
71-5232-14-00	77
71-5232-60-00	77
71-5233-00-00	688
71-5234-00-00	688
71-5235-00-00	688
71-5236-14-37	101, 105, 111
71-5272-00-00	689
71-5320-00-00	205
71-5321-00-00	205
71-5322-00-00	205
71-5323-00-00	205
71-5324-00-00	205

Reference	Page
71-5326-00-00	688
71-5327-00-00	688
71-5328-00-00	688
71-5420-14-00	77
71-5420-60-00	77
71-5421-14-00	77
71-5421-60-00	77
71-5422-14-00	77
71-5422-60-00	77
71-5424-14-00	77
71-5424-60-00	77
71-5454-60-00	100, 104, 110
71-5455-00-00	207
71-5464-14-00	76
71-5464-60-00	76
71-5465-14-00	76
71-5465-60-00	76
71-5466-14-00	76
71-5466-60-00	76
71-5467-00-00	688
71-5477-14-M2	115
71-5482-14-00	209
71-5482-N3-00	209
71-5483-14-00	209
71-5483-N3-00	209
71-5484-00-00	209
71-5485-00-00	209
71-5486-00-00	209
71-5487-00-00	209, 690
71-5489-00-00	678
71-8969-00-00	534, 582, 698
71-9197-05-05	691
71-9199-05-05	698
71-9262-05-05	698
71-9291-34-34	642
71-9292-34-34	642
71-9487-34-34	496, 500, 506, 508, 511, 698
71-9487-Z5-Z5	496, 500, 506, 508, 511, 698
71-9514-52-52	632
71-9577-05-37	526
71-9711-00-00V1	555, 556, 570, 572
71-9712-00-00V1	555, 556, 570, 572
71-9713-00-00	582
71-9714-00-00	582
71-9729-54-M3	648
71-9744-05-05	698
71-9745-05-05	698
71-9746-05-05	500, 506, 508, 511, 698
71-9781-00-00	534

Reference	Page
71-9816-00-00	694
71-9817-00-00	694
71-9844-05-05	584, 602
71-9845-05-05	584, 602
71-9846-05-05	584, 602
71-9875-05-05	526
71-9884-00-CL	542
71-9884-00-CM	542
71-9886-00-CL	557
71-9886-00-CM	557
75-4366-21-K3	447
75-4371-K3-M1	443
75-4858-K3-F1	446
75-5314-21-K3	444
80-2427-BP-37	638
80-4528-BP-37	640
80-4529-BP-37	638
80-4614-BQ-37	636
80-4970-BQ-M2	634
80-4971-BQ-M2	634
80-4972-BQ-M2	504
80-5292-BQ-37	636
80-5293-BP-37	638
80-5294-BP-37	638
80-5295-BP-37	640
81-3145-BP-BP	638, 640, 642
81-9914-34-34	630
81-9915-34-34	630
83-3239-BB-M2	630
90-1689-21-37	88, 438
90-1690-21-37	88, 438
90-1720-14-00	95
90-1722-14-00	95
90-1782-14-37	116
90-1789-21-37	88, 438
90-1792-21-37	88, 438
90-1809-14-00	95
90-1813-14-00	95
90-2022-14-M3	120
90-2022-14-OE	120
90-2022-N3-M3	120
90-2022-N3-OE	120
90-2023-14-M3	120
90-2023-14-OE	120
90-2023-N3-M3	120
90-2023-N3-OE	120
90-2024-14-M3	120
90-2024-14-OE	120
90-2024-N3-M3	120
90-2024-N3-OE	120
90-2025-14-M3	120
90-2025-14-OE	120
90-2025-N3-M3	120
90-2025-N3-OE	120
90-2026-14-M3	120

Reference	Page
90-2026-14-OE	120
90-2026-N3-M3	120
90-2026-N3-OE	120
90-2027-14-M3	120
90-2027-14-OE	120
90-2027-N3-M3	120
90-2027-N3-OE	120
90-2028-14-M3	120
90-2028-14-OE	120
90-2028-N3-M3	120
90-2028-N3-OE	120
90-2029-14-M3	120
90-2029-14-OE	120
90-2029-N3-M3	120
90-2029-N3-OE	120
90-2582-14-37	56
90-2594-14-37	56
90-2599-14-37	56
90-2605-14-37	56
90-2611-14-37	56
90-2613-14-37	56
90-2614-14-37	56
90-2615-14-37	56
90-2616-14-37	56
90-2899-14-M3V1	121
90-2899-14-OE	121
90-2902-14-00	94
90-2903-14-00	94
90-2979-14-37	119
90-2979-N3-37	119
90-2980-14-37	119
90-2980-N3-37	119
90-2981-14-00	149
90-2981-60-00	149
90-2984-14-00	149
90-2984-60-00	149
90-2985-14-OS	151
90-2985-60-OS	151
90-2986-14-OS	151
90-2986-60-OS	151
90-2987-14-OS	151
90-2987-60-OS	151
90-2988-14-OS	151
90-2988-60-OS	151
90-2989-14-OS	151
90-2989-60-OS	151
90-2990-14-OS	151
90-2990-60-OS	151
90-2991-14-DU	149
90-2991-14-OE	149
90-2991-14-OU	149
90-2991-60-DU	149
90-2991-60-OE	149
90-2991-60-OU	149
90-2992-14-DU	149

Reference	Page
90-2992-14-OE	149
90-2992-14-OU	149
90-2992-60-DU	149
90-2992-60-OE	149
90-2992-60-OU	149
90-2993-14-DU	149
90-2993-14-OE	149
90-2993-14-OU	149
90-2993-60-DU	149
90-2993-60-OE	149
90-2993-60-OU	149
90-2994-14-DU	149
90-2994-14-OE	149
90-2994-14-OU	149
90-2994-60-DU	149
90-2994-60-OE	149
90-2994-60-OU	149
90-2995-14-DU	149
90-2995-14-OE	149
90-2995-14-OU	149
90-2995-60-DU	149
90-2995-60-OE	149
90-2995-60-OU	149
90-2996-14-DU	149
90-2996-14-OE	149
90-2996-14-OU	149
90-2996-60-DU	149
90-2996-60-OE	149
90-2996-60-OU	149
90-2997-14-OU	149
90-2997-60-OU	149
90-2998-14-OU	149
90-2998-60-OU	149
90-2999-14-OU	149
90-2999-60-OU	149
90-3000-14-OU	149
90-3000-60-OU	149
90-3204-14-OU	149
90-3204-60-OU	149
90-3207-14-OU	149
90-3207-60-OU	149
90-3208-14-DU	151
90-3208-14-OE	151
90-3208-14-OU	151
90-3208-60-DU	151
90-3208-60-OE	151
90-3208-60-OU	151
90-3209-14-DU	151
90-3209-14-OE	151
90-3209-14-OU	151
90-3209-60-DU	151
90-3209-60-OE	151
90-3209-60-OU	151
90-3210-14-OU	151
90-3210-60-OU	151

Reference	Page
90-3211-14-OU	151
90-3211-60-OU	151
90-3297-14-37	131
90-3297-N3-37	131
90-3298-14-37	131
90-3298-N3-37	131
90-3299-14-37	131
90-3299-N3-37	131
90-3489-54-S2	185
90-3501-14-37	130
90-3501-N3-37	130
90-3502-14-37	130
90-3502-N3-37	130
90-3503-14-37	130
90-3503-N3-37	130
90-3504-14-37	130
90-3504-N3-37	130
90-3505-14-37	130
90-3505-N3-37	130
90-3506-14-37	130
90-3506-N3-37	130
90-3507-14-37	131
90-3507-N3-37	131
90-3508-14-37	131
90-3508-N3-37	131
90-3509-14-37	131
90-3509-N3-37	131
90-3512-14-37	56
90-3513-14-37	56
90-3514-14-37	56
90-3521-14-37	119
90-3521-N3-37	119
90-3522-14-37	119
90-3522-N3-37	119
90-3523-14-DU	149
90-3523-14-OE	149
90-3523-14-OU	149
90-3523-60-DU	149
90-3523-60-OE	149
90-3523-60-OU	149
90-3524-14-DU	149
90-3524-14-OE	149
90-3524-14-OU	149
90-3524-60-DU	149
90-3524-60-OE	149
90-3524-60-OU	149
90-3525-14-DU	149
90-3525-14-OE	149
90-3525-14-OU	149
90-3525-60-DU	149
90-3525-60-OE	149
90-3525-60-OU	149
90-3526-14-OU	149
90-3526-60-OU	149
90-3527-14-OU	149

Reference	Page
90-3527-60-OU	149
90-3528-14-OU	149
90-3528-60-OU	149
90-3529-14-DU	151
90-3529-14-OE	151
90-3529-14-OU	151
90-3529-60-DU	151
90-3529-60-OE	151
90-3529-60-OU	151
90-3530-14-OU	151
90-3530-60-OU	151
90-3546-14-00	153
90-3546-60-00	153
90-3547-14-00	154
90-3547-60-00	154
90-3550-14-00	153
90-3550-60-00	153
90-3925-14-M3	121
90-3926-14-M3	121
90-3927-14-M3	121
90-3928-14-M3	121
90-3929-14-M3	121
90-3930-14-M3	121
90-3981-14-37	119
90-3981-N3-37	119
90-3982-14-37	119
90-3982-N3-37	119
90-3983-14-37	119
90-3983-N3-37	119
90-3984-14-M3	120
90-3984-14-OE	120
90-3984-N3-M3	120
90-3984-N3-OE	120
90-3985-14-M3	120
90-3985-14-OE	120
90-3985-N3-M3	120
90-3985-N3-OE	120
90-4041-14-37	130
90-4041-N3-37	130
90-4042-14-37	130
90-4042-N3-37	130
90-4043-14-37	130
90-4043-N3-37	130
90-4044-14-37	130
90-4044-N3-37	130
90-4045-14-37	130
90-4045-N3-37	130
90-4046-14-37	130
90-4046-N3-37	130
90-4047-14-37	131
90-4047-N3-37	131
90-4048-14-37	131
90-4048-N3-37	131
90-4049-14-37	131
90-4049-N3-37	131

Reference	Page
90-4349-14-B9	89, 442
90-4350-05-05	89
90-4350-14-14	89
90-4735-14-37	130
90-4735-N3-37	130
90-4736-14-37	130
90-4736-N3-37	130
90-4737-14-37	130
90-4737-N3-37	130
90-4738-14-37	130
90-4738-N3-37	130
90-4739-14-37	130
90-4739-N3-37	130
90-4740-14-37	130
90-4740-N3-37	130
90-4748-14-37	119
90-4748-N3-37	119
90-4749-14-37	119
90-4749-N3-37	119
90-4766-14-37	135
90-4767-14-37	135
90-4768-14-37	135
90-4769-14-37	135
90-4770-14-37	135
90-4771-14-37	135
90-4772-14-37	135
90-4773-14-37	135
90-4774-14-37	135
90-4775-14-37	135
90-4776-14-37	135
90-4777-14-37	135
90-4778-14-37	135
90-4779-14-37	135
90-4780-14-37	135
90-4781-14-37	135
90-4782-14-37	135
90-4783-14-37	135
90-4788-14-37	135
90-4789-14-37	135
90-4790-14-37	135
90-4791-14-37	135
90-4792-14-37	135
90-4793-14-37	135
90-4799-14-OS	165
90-4799-14-OU	165
90-4799-N3-OS	165
90-4799-N3-OU	165
90-4800-14-OS	165
90-4800-14-OU	165
90-4800-N3-OS	165
90-4800-N3-OU	165
90-4842-14-37	56
90-4843-14-37	56
90-4844-14-37	56
90-4845-14-37	56

Reference	Page
90-4846-14-37	56
90-4847-14-37	56
90-4852-14-37	127
90-4852-N3-37	127
90-4853-14-37	127
90-4853-N3-37	127
90-4854-14-37	127
90-4854-N3-37	127
90-4855-14-37	127
90-4855-N3-37	127
90-4880-14-M3	121
90-4880-14-OE	121
90-4881-14-M3	121
90-4881-14-OE	121
90-4883-14-M3	121
90-4883-14-OE	121
90-4885-14-M3	121
90-4885-14-OE	121
90-4886-14-M3	121
90-4886-14-OE	121
90-5139-14-37	133
90-5143-14-37	133
90-5144-14-37	133
90-5147-14-37	133
90-5149-14-37	133
90-5472-14-OS	165
90-5472-14-OU	165
90-5472-N3-OS	165
90-5472-N3-OU	165
90-5473-14-OS	165
90-5473-14-OU	165
90-5473-N3-OS	165
90-5473-N3-OU	165
90-5474-14-OS	165
90-5474-14-OU	165
90-5474-N3-OS	165
90-5474-N3-OU	165
90-5475-14-OS	165
90-5475-14-OU	165
90-5475-N3-OS	165
90-5475-N3-OU	165
91-0150-00-00	199
91-0171-00-00	199
91-0175-00-00	199
91-2361-00-00	201
91-2365-00-00	201
91-2379-00-00	201
91-2491-00-00	199
91-2492-00-00	203
91-3282-00-00	201
91-3408-54-M2	197
91-3411-54-M2	197
91-4671-00-00	197
91-4763-00-00	201
91-4764-00-00	203

Reference	Page
91-4765-00-00	203
91-5452-00-00	205
91-5453-00-00	205
ACT-9044-14-00	154
ACT-9044-60-00	154
ACT-9045-14-00	154
ACT-9045-60-00	154
ACT-9083-N3-00	76, 167, 169
ACT-9090-14-00	76, 167, 169
ACT-9090-N3-00	76, 167, 169, 170
ACT-9091-N3-00	167, 169, 170
ACT-9092-00-00	167
ACT-9093-00-00	169, 170
ACT-9096-00-00	167
ACT-9097-00-00	169, 170
ACT-9105-14-00	45, 47, 49, 64, 70, 71, 73, 75
ACT-9105-60-00	45, 47, 49, 64, 70, 71, 73, 75
ACT-9106-14-00	45, 47, 49, 64, 70, 71, 73, 75
ACT-9106-60-00	45, 47, 49, 64, 70, 71, 73, 75
ACT-9114-00-00	167
ACT-9135-60-00	51, 53, 58
ACT-9150-14-M1	167
ACT-9150-N3-M1	167
ACT-9151-14-M1	169
ACT-9151-N3-M1	169
ACT-9152-14-M1	167
ACT-9153-14-M1	169
ACT-9154-14-M1	167
ACT-9154-N3-M1	167
ACT-9155-14-M1	169
ACT-9155-N3-M1	169
ACT-9165-48-00	76
ACT-9180-60-00	65, 129, 141, 149, 151, 130, 131
ACT-9181-14-00	65
ACT-9181-60-00	65
ACT-BAL-003	691
ACT-BAL-004	691
ACT-BAL-005	691
ACT-BAL-006	691
ACT-FLL-011	678
ACT-FLL-013	678
ACT-FLL-015	678
ACT-FLL-017	678
ACT-FLL-020V1	679
ACT-FLL-021V1	679
ACT-FLL-022	679

Reference	Page
ACT-FLL-023	679
ACT-FLL-024	679
ACT-FLL-025	679
ACT-FLL-026	679
ACT-FLL-027	679
ACT-FLL-028	679
ACT-FLL-029	679
ACT-FLL-030	678
ACT-FLL-031	678
ACT-FLL-032	678
ACT-FLL-033	678
ACT-TRA-001	691
ACT-TRA-002	691, 679
AD-0654-N3-00	170
AD-0656-N3-00	166
AD-0657-14-00	166
AD-0657-N3-00	166
AD-0658-N3-00	166
AD-0659-N3-00	166
AD-0660-14-00	166
AD-0660-N3-00	166
AD-0661-N3-00	166
AD-0662-N3-00	168
AD-0663-14-00	168
AD-0663-N3-00	168
AD-0664-N3-00	168
AD-0665-N3-00	168
AD-0666-14-00	168
AD-0666-N3-00	168
AD-0680-N3-00	166
AD-0681-14-00	166
AD-0681-N3-00	166
AD-0682-N3-00	166
AD-0683-N3-00	166
AD-0684-14-00	166
AD-0684-N3-00	166
AD-0685-N3-00	166
AD-0686-N3-00	168
AD-0687-14-00	168
AD-0687-N3-00	168
AD-0688-N3-00	168
AD-0689-N3-00	168
AD-0690-14-00	168
AD-0690-N3-00	168
AD-0691-N3-00	166
AD-0692-14-00	166
AD-0692-N3-00	166
AD-0693-N3-00	166
AD-0694-N3-00	166
AD-0695-14-00	166
AD-0695-N3-00	166
AD-0696-N3-00	166
AD-0697-N3-00	168
AD-0698-14-00	168
AD-0698-N3-00	168

Reference	Page
AD-0699-N3-00	168
AD-0700-N3-00	168
AD-0701-14-00	168
AD-0701-N3-00	168
DM-0053-14-00	145
DM-0053-N3-00	145
DM-0054-14-00	145
DM-0054-N3-00	145
DM-0055-14-00	145
DM-0055-N3-00	145
DM-0056-14-00	145
DM-0056-N3-00	145
DM-0061-14-00	144
DM-0061-N3-00	144
DM-0062-14-00	144
DM-0062-N3-00	144
DM-0063-14-00	144
DM-0063-N3-00	144
DM-0064-14-00	144
DM-0064-N3-00	144
DM-0081-14-00	146
DM-0081-60-00	146
DM-0082-14-00	146
DM-0082-60-00	146
DM-0083-14-00	146
DM-0083-60-00	146
DM-0084-14-00	146
DM-0084-60-00	146
DM-0093-14-00	147
DM-0093-60-00	147
DM-0094-14-00	147
DM-0094-60-00	147
DM-0095-14-00	147
DM-0095-60-00	147
DM-0096-14-00	147
DM-0096-60-00	147
DM-1100-14-00	153
DM-1100-60-00	153
DM-1101-14-00	154
DM-1101-60-00	154
DM-1106-N3-00	91
DM-1107-14-00	89
DM-1150-14-00	153
DM-1150-60-00	153
DM-1151-14-00	153
DM-1151-60-00	153
DM-1155-14-00	144
DM-1155-N3-00	144
DM-1156-14-00	144
DM-1156-N3-00	144
DM-1157-14-00	144
DM-1157-N3-00	144
DM-1158-14-00	144
DM-1158-N3-00	144
DM-1159-14-00	146

Reference	Page
DM-1159-60-00	146
DM-1160-14-00	146
DM-1160-60-00	146
DM-1161-14-00	146
DM-1161-60-00	146
DM-1162-14-00	146
DM-1162-60-00	146
DN-0270-14-00	129
DN-0270-N3-00	129
DN-0273-14-00	129
DN-0273-N3-00	129
DN-0274-14-00	129
DN-0274-N3-00	129
DN-0511-S2-00	185
DN-0520-14-00	87
DN-0520-S2-00	87
DN-0521-14-00	86
DN-0521-S2-00	86
DN-0522-14-00	86
DN-0522-S2-00	86
DN-0525-14-00	86
DN-0525-S2-00	86
DN-0526-14-00	86
DN-0526-S2-00	86
DN-0527-14-00	87
DN-0527-S2-00	87
DN-1400-14-00	117
DN-1401-14-00	117
DN-1402-14-00	117
DN-1403-14-00	117
DN-1405-14-00	117
DN-1406-14-00	117
DN-1407-14-00	117
DN-1408-14-00	117
DN-1409-14-00	117
DN-1410-14-00	117
DN-1600-14-00V1	93
DN-1600-23-00V1	93
DN-1600-60-00V1	93
DN-1601-14-00V1	93
DN-1601-23-00V1	93
DN-1601-60-00V1	93
DN-1602-14-00V1	93
DN-1652-14-00	129
DN-1652-N3-00	129
DN-1653-14-00	129
DN-1653-N3-00	129
DN-1695-14-00	84
DN-1696-14-00	84
DN-1697-14-00	85
DN-1698-14-00	85
EP-0349-14-XY	193
EP-0349-N3-XY	193
EP-0356-14-00	193
EP-0356-N3-00	193

Reference	Page
EP-1615-14-00	170
EP-1617-14-00	166
EP-1618-14-00	166
EP-1619-14-00	166
EP-1620-14-00	166
EP-1621-14-00	166
EP-1622-14-00	166
EP-1623-14-00	168
EP-1624-14-00	168
EP-1625-14-00	168
EP-1626-14-00	168
EP-1627-14-00	168
EP-1640-14-00	166
EP-1641-14-00	166
EP-1642-14-00	166
EP-1643-14-00	166
EP-1644-14-00	166
EP-1645-14-00	166
EP-1646-14-00	168
EP-1647-14-00	168
EP-1648-14-00	168
EP-1649-14-00	168
EP-1650-14-00	168
EP-1651-14-00	166
EP-1652-14-00	166
EP-1653-14-00	166
EP-1654-14-00	166
EP-1655-14-00	166
EP-1656-14-00	166
EP-1657-14-00	168
EP-1658-14-00	168
EP-1659-14-00	168
EP-1660-14-00	168
EP-1661-14-00	168
LT-20	518
PAN-157-14	262
PAN-157-BY	262
PAN-159-14	262
PAN-159-BY	262
PAN-161-14	262
PAN-161-BY	262
PAN-163-05	246, 394
PAN-163-14	246, 394
PAN-164-05	246, 248, 394
PAN-164-14	246, 248, 394
PAN-175-14	262
PAN-175-BY	262
PAN-176-14	263
PAN-176-BY	263
PAN-177-14	262
PAN-177-BY	262
PAN-178-14	263
PAN-178-BY	263
PAN-179-14	263

Reference	Page
PAN-179-BY	263
PAN-180-14	263
PAN-180-BY	263
PAN-181-14	263
PAN-181-BY	263
PAN-182-14	263
PAN-182-BY	263
PAN-182-T001	263
PAN-183-14	263
PAN-183-BY	263
PAN-184-14	262
PAN-184-BY	262
PAN-194-AJ	264
PAN-198-V7	264
PAN-199-V7	264
PAN-219-05	262
PAN-219-14	262
PAN-220-V7	264
PAN-221-V7	264
PR-0946-14-00	65
PR-0946-60-00	65
PR-0949-14-37	65
PR-0949-60-37	65
PR-0950-14-37	65
PR-0950-60-37	65
PR-0951-14-00	65
PR-0951-60-00	65
PR-0952-14-37	65
PR-0952-60-37	65
PR-0953-14-37	65
PR-0953-60-37	65
PR-0954-14-37	65
PR-0954-60-37	65
PR-0955-14-00	65
PR-0955-60-00	65
SAN-1C-E50	512
SAN-1C-E60	512
SAN-1C-S12	512
SAN-1C-S25	512
SAN-1C-S45	512
SAN-1N-E50	512
SAN-1N-E60	512
SAN-1N-S12	512
SAN-1N-S25	512
SAN-1N-S45	512
SAN-1W-E50	512
SAN-1W-E60	512
SAN-1W-S12	512
SAN-1W-S25	512
SAN-1W-S45	512

IMPORTANT INFORMATION

- Todos los derechos reservados. Ninguna parte de este libro puede ser reproducida en ningún formato de papel o electrónico, sin el consentimiento previo del editor o de los propietarios de los derechos.
- All rights reserved. No part of this publication may be reproduced or transmitted in any form or by any means, electronic storage and retrieval system, without permission in writing from the copyright owner(s).
- Tous droits réservés. Aucune partie de ce livre ne pourra être reproduite au format papier ou électronique sans l'autorisation préalable de l'éditeur ou du propriétaire des droits.
- Sämtliche Rechte vorbehalten. Kein Teil dieses Buches darf weder in Papier- oder elektronischem Format ohne ausdrückliche Zustimmung des Herausgebers oder der Inhaber der Urheberrechte wiedergegeben oder vervielfältigt werden.
- Tutti i diritti riservati. Nessuna parte di questo catalogo può essere riprodotta in nessun formato cartaceo o elettronico, senza la previa autorizzazione dell'editore o dei proprietari dei diritti.
- Todos os direitos reservados. Nenhuma parte deste livro pode ser reproduzida em qualquer formato de papel ou electrónico, sem o consentimento prévio do editor ou dos proprietários dos direitos.
- Все права защищены. Запрещено использование любого материала из данного каталога без специального разрешения носителя прав собственности.
- Wszelkie prawa zastrzeżone. Żadna część tej publikacji nie może być powielana w jakiegokolwiek formie na papierze ani na elektronicznym nośniku, bez wcześniejszej zgody na piśmie wydawcy lub właściciela praw autorskich.

Debido a la constante evolución tecnológica del LED, los productos que incluyen esta fuente de luz pueden experimentar variaciones en sus características técnicas con el objetivo de poder ofrecer siempre las máximas prestaciones en nuestros productos.

Due to the constant evolution of LED technology, those products which offer this source of light can vary in their technical characteristics in order for us to offer maximum product performance.

En raison de l'évolution constante de la technologie LED, les produits dotés de cette source lumineuse peuvent connaître des variations dans leurs caractéristiques techniques, en vue de toujours en optimiser les prestations.

Aufgrund der kontinuierlichen Fortschritte bei der LED-Technik, mit denen wir sicherstellen, dass wir stets Artikel auf dem neusten Stand der Technik liefern, können sich die Merkmale der Produkte dieser Lichtquelle ändern.

A causa della costante evoluzione tecnologica del LED, i prodotti che contengono questa fonte di luce possono subire variazioni nelle loro caratteristiche tecniche con l'obiettivo di offrire sempre massime prestazioni.

Devido à constante evolução da tecnologia LED, os produtos que incluem esta fonte de luz podem apresentar variações nas suas características técnicas com o objetivo de garantir sempre o máximo desempenho dos nossos produtos.

В силу постоянного технологического прогресса в области производства светодиодов, технические характеристики нашей продукции, в которой используется этот источник света, могут претерпевать изменения, всегда с целью обеспечения наилучших потребительских свойств.

Z uwagi na ciągły rozwój technologiczny LED, produkty które zawierają to źródło światła mogą ulegać zmianom pod względem właściwości technicznych, tak aby móc zawsze oferować maksymalną ilość świadczeń w naszych produktach.

OTHER LEDS-C4 CATALOGUES

HOSPITALITY LIGHTING

ILUMINACIÓN PARA HOTELES
HOTEL LIGHTING
ÉCLAIRAGE HÔTELIER
HOTELBELEUCHTUNG
ILLUMINAZIONE PER HOTEL
ILUMINAÇÃO PARA HOTÉIS
ОСВЕЩЕНИЕ ДЛЯ ОТЕЛЕЙ
OŚWIETLENIE DLA HOTELI



RETAIL LIGHTING

ILUMINACIÓN COMERCIAL
SHOP LIGHTING
ÉCLAIRAGE COMMERCIAL
SHOPBELEUCHTUNG
ILLUMINAZIONE COMMERCIALE
ILUMINAÇÃO COMERCIAL
ОСВЕЩЕНИЕ ДЛЯ ТОРГОВЫХ ПОМЕЩЕНИЙ
OŚWIETLENIE HANDLOWE

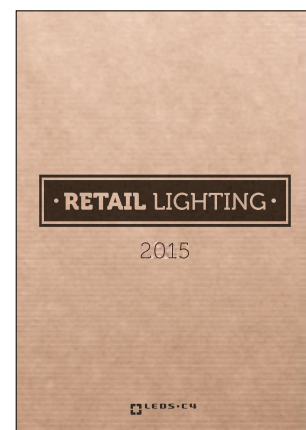

CONTEMPORARY DESIGN

DISEÑO CONTEMPORÁNEO
CONTEMPORARY DESIGN
DESIGN CONTEMPORAIN
ZEITGENÖSSISCHES DESIGN
DESIGN CONTEMPORANEO
DESIGN CONTEMPORÁNEO
СОВРЕМЕННЫЙ ДИЗАЙН
WSPÓŁCZESNE WZORNICTWO



GROK
by LEDS-C4

CLOSE TO YOU

HEADQUARTERS

LEDSC4, S.A.

Afores s/n 25750 Torà (Lleida)
SPAIN
Tel.: + 973 468 100
e-mail: leds-c4@leds-c4.com

CUSTOMER SERVICE DEPARTMENT

ESPAÑA

Tel.: + 34 973 468 101
e-mail: spain@leds-c4.com

EUROPE

Tel.: + 34 973 468 102
e-mail: europe@leds-c4.com

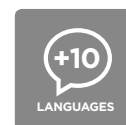

UK

Tel.: 0808 234 2641
e-mail: uk@leds-c4.com

AMÉRICA LATINA

Tel.: + 34 973 468 115
e-mail: latinamerica@leds-c4.com

FRANCE

Tel.: + 34 973 468 130
e-mail: france@leds-c4.com

USA - CANADA

Tel. USA: + 1-888-3710243
Tel. Canada: + 1-866-5636666
e-mail: usa@leds-c4.com

ITALIA

Tel.: + 34 973 468 102
e-mail: italia@leds-c4.com

ASIA - PACIFIC & AFRICA

Tel.: + 34 973 468 116
e-mail: asiapacific@leds-c4.com
africa@leds-c4.com

PORTUGAL

Tel.: + 34 973 468 130
e-mail: portugal@leds-c4.com

MIDDLE EAST COUNTRIES

LEDSC4 LIGHTING DMCC

Fortune Executive Tower - JLT
PO 336910 - DUBAI - UAE
Tel. + 971 4458 4272
e-mail: middleeast@leds-c4dubai.com

POLAND

LEDSC4 POLSKA sp. z o.o.

ul.Nektarowa 11B 52-210. Wrocław
POLAND
Tel.: + 48 71 733 64 01
e-mail: biuro@leds-polska.pl



WWW.LEDS-C4.COM