



LUTEC China Head Office
CN8, Far-East Industry Park, Yuyao, Zhejiang, China
+86-574-62760832
Info@lutec.net

LUTEC in DACH – ECO-LIGHT Leuchten GmbH
+49-228-9691090
kirwel@eco-light.biz

LUTEC FRANCE
+33-04-75602568
jeanmichel@lutec-france.fr

LUTEC in HUNGARY – Lutec Lighting Kft
+36-30-2193952
szlavicsek.zsolt@lutec.net

LUTEC in IBERIA – Lutec Lighting Iberia, S.L.
+34-93-5001221
administracion@luteciberia.com

LUTEC in ITALY – Lightec Srl
+39-031-3551342
info@lightecsrl.com

LUTEC (UK) Ltd
+44-1992-760870
sales@lutecuk.com

LUTEC in BNL – Light Things BeNeLux
+32-3-454-01-09
info@ltl-international.eu

LUTEC in ROMANIA – Redo Group Srl
+40-234-562-452
stefan.craciun@redogroup.ro

LUTEC in UKRAINE – Eurotrade
+38 (044) 496-74-83
sash@eurotrade.net.ua

LUTEC in GREECE – New Light Ltd
+30-2104817321
soiram@otenet.gr

LUTEC in RUSSIA – Oasis Light
+7-499-5501529
agata-v@rambler.ru

LUTEC MIDDLE EAST
+971-6-5528980
admin@lutecme.com

LUTEC USA LLC
+704-980-4135
shelley.greenberg@lutec.net

LUTEC in KOREA – Belko Co.,Ltd
+82-2-465-0603
LutecKorea@naver.com

LUTEC in AUSTRALIA – Evolt Pty Ltd
+61-2-9502-1161
sales@evolt.com.au



www.lutec.net

LUTEC

OUTDOOR LIGHTING 2017



OUTDOOR LIGHTING



OUTDOOR LIGHTING



Innovation-Performance-Design-Connected-Clever-Fun

LUTEC a global & major player in the field of qualitative outdoor lighting.

5

Architectural

P114

Tradition

P134

Solar

P202

Security &
Worklight

P246

Functional

P284

Activity segments

Architectural

A



Architectural

ARCHITECTURAL applies to all the lighting installations for homes, terraces and gardens.

Some products are unique, some are designed as a series. The points to consider are multiple. Each lamp has two lives, one during the day, the other at night.

The first impact is decorative, whether we like it. The second is what we expect and are looking for in terms of light effect.

It is the combination of these two elements that gives the best adapted product to each of us.

wall
ceiling
bollards



ARCHITECTURAL

WALL									
	6144S-1 MINI LEDSPOT / P2	6144S-2 MINI LEDSPOT / P2	6144S-1-PIR MINI LEDSPOT / P4	6144S-2-PIR MINI LEDSPOT / P4	6144-1 LEDSPOT / P6	6144-2 LEDSPOT / P6	6141-1 CYLIN / P12	6260 TRUMPET / P16	6160 EGGO / P18
		 NEW							
2521S ANDA / P22	6163S MERIDIAN / P26	6163S-PIR MERIDIAN / P26	6163 MERIDIAN / P26	1877S CONE / P30	1876S CONE / P32	1876 CONE / P32	2253S SPRIL / P36	2251S SPRIL / P36	2253M SPRIL / P38
							 NEW	 NEW	 NEW
2251M SPRIL / P38	1880S GHOST / P42	1880L GHOST / P42	1881S GHOST / P42	2256S GHOST / P44	6166 ARMOR / P48	ST031051 FLAT / P50	ST5001 SLIM / P52	ST5001-PIR SLIM / P52	ST033071 FACE / P54
 NEW									 NEW
ST033071-PIR FACE / P54	1894 EVEN / P56	1899 SECO / P58	1849 ORIGO / P60	1846 BOX CUBE / P62	1843 BOX CUBE / P62	1853 CLIP / P64	1836 CITY / P66	1838S DELTA / P68	1895 ZERTA / P70
									
1896 TONA / P72	1896-PIR TONA / P72	1860 EYES / P74	1860L EYES / P74	1861 EYES / P76	1868 EYES / P76	1865 RADIUS / P78	1866 RADIUS / P78	1882 SANDWY / P80	1871 MASK / P82

ARCHITECTURAL

									
1872 MASK / P82	1869 PILO / P84	1862 EVANS / P86	1863 EVANS / P86	1879 SPLIT / P88	1891S GEMINI / P90	1891M GEMINI / P90	1890S GEMINI / P92	1890M GEMINI / P92	ST5214 TUBE / P94
			 NEW	 NEW			 NEW	 NEW	 NEW
ST5215 TUBE / P94	ST5212 CRYSTAL / P96	ST5216 CRYSTAL / P96	ST5108 LUCA / P98	ST033023 LUCA / P98	ST5218 BILAYER / P100	ST5219 BILAYER / P100	ST6057 PATH / P102	ST6057-PIR PATH / P102	ST6058 PATH / P104
 NEW									CEILING
ST6058-PIR PATH / P104	6041 FOCUS / P106	6040 FOCUS / P106	6051 FOCUS / P110	6050 FOCUS / P110	ST6041 FOCUS / P112	ST6040 FOCUS / P112	ST6051 FOCUS / P114	ST6050 FOCUS / P114	
	BOLLARD						 NEW		
6042 FOCUS / P108		6146S-1 MINI LEDSPOT / P8	6146S-2 MINI LEDSPOT / P8	6146-2 LEDSPOT / P10	6142-1 CYLIN / P14	6142-2 CYLIN / P14	6261A TRUMPET / P16	6161 EGGO / P20	2522S ANDA / P24
									
6164S MERIDIAN / P28	6164 MERIDIAN / P28	11876N3 CONE / P34	21876N3 CONE / P34	2252S SPRIL / P40	2252M SPRIL / P40	2257S GHOST / P46	6167 ARMOR / P48	ST031052-450 FLAT / P50	6048 FOCUS / P108

MINI LEDSPOT

wall

One or two light head versions. The lights heads can rotate 320° and will give you a perfect solution as a spotlight or wall washer. It will create the desired ambiance.



6144S-1 gr
6144S-1 si

CLASS I CE
IP65
LED 9W
605 Lumen
Die Cast Aluminium

A+

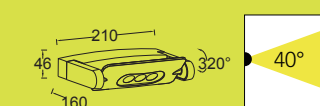

6144S-2 gr
6144S-2 si

CLASS I CE
IP65
LED 18W
1210 Lumen
Die Cast Aluminium

A+



MINI LEDSPOT

wall sensor



Exocentric led spot, one or two heads, with a double movement, rotation & inclination



Adjustable PIR motion sensor with a 150° detection area



6144S-1-PIR gr

CLASS I CE
IP54
LED 9W
605 Lumen
Die Cast Aluminium

A+
4000K

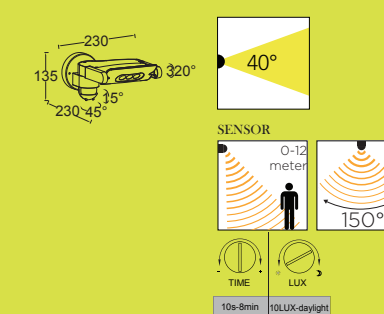

6144S-2-PIR gr

CLASS I CE
IP54
LED 18W
1210 Lumen
Die Cast Aluminium

A+
4000K

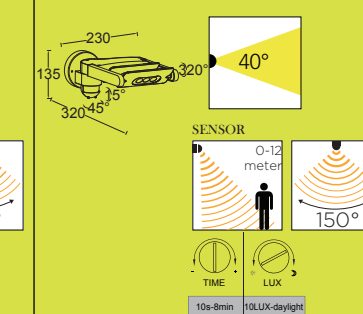

LEDSPOT

wall

Spectacular lighting fixture assuring a very powerful and adjustable light beam. The ideal product for multiple professional applications.



6144-1 gr

CLASS I CE
IP65
LED 25W
2700 Lumen
Die Cast Aluminium

A+

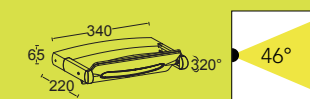

6144-2 gr

CLASS I CE
IP65
LED 50W
5400 Lumen
Die Cast Aluminium

A+





MINI LEDSPOT

bollard

This bollard is the perfect companion to light the pathways & terraces in your garden. The multidirectional heads will always direct the LED light to the desired spot.



6146S-1-526 gr

CLASS I CE
IP65
LED 9W
605 Lumen
Die Cast Aluminium

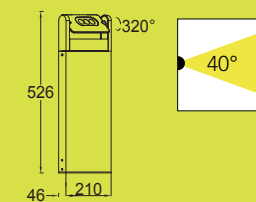

6146S-2-616 gr

CLASS I CE
IP65
LED 18W
1210 Lumen
Die Cast Aluminium

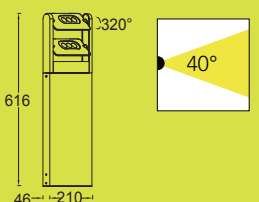

LEDSPOT

bollard

Robust bollard in heavy duty die-cast aluminium, with two adjustable spot heads, brings you a sea of powerful LED light on your driveway and along your pathway.



6146-2 gr

CLASS I CE
 IP65
 LED 50W
 5400 Lumen
 Die Cast Aluminium

A+

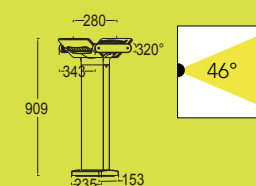

CYLIN

wall

Atypical wall light, with one or two slim & adjustable spot heads, fully integrated in the cylindrical design. Can be used perfectly as a wall washer with

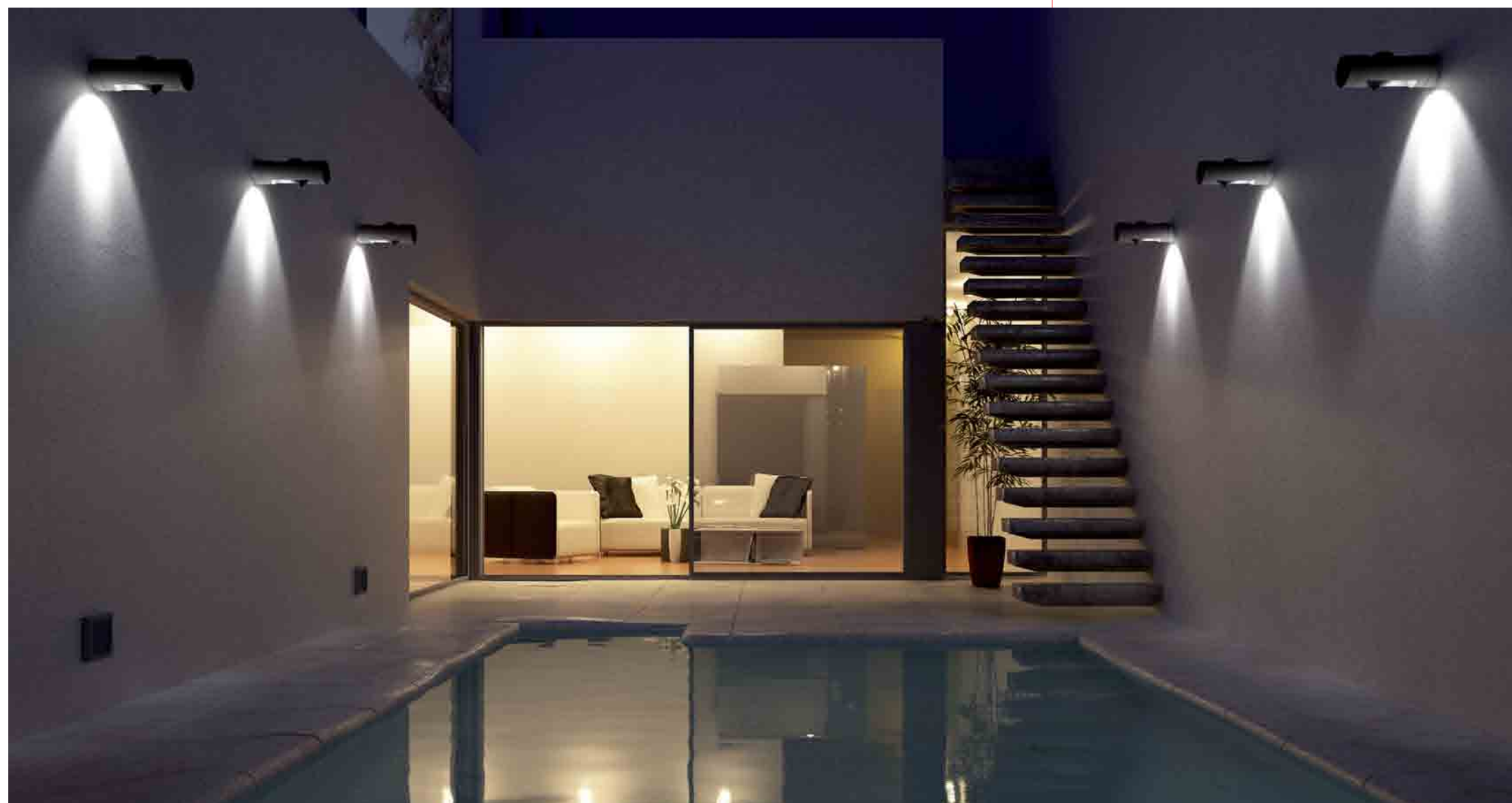

6141-1 gr

CLASS II CE
 IP54
 LED 9W
 500 Lumen
 Die Cast Aluminium
A+

4000K

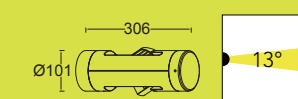

CYLIN

bollard

3 sizes with a single or double spot head offering a solution for every project along your pathway and terrace or to light a large ground surface. Shows a strong architectural look in a multiple aligned installation.

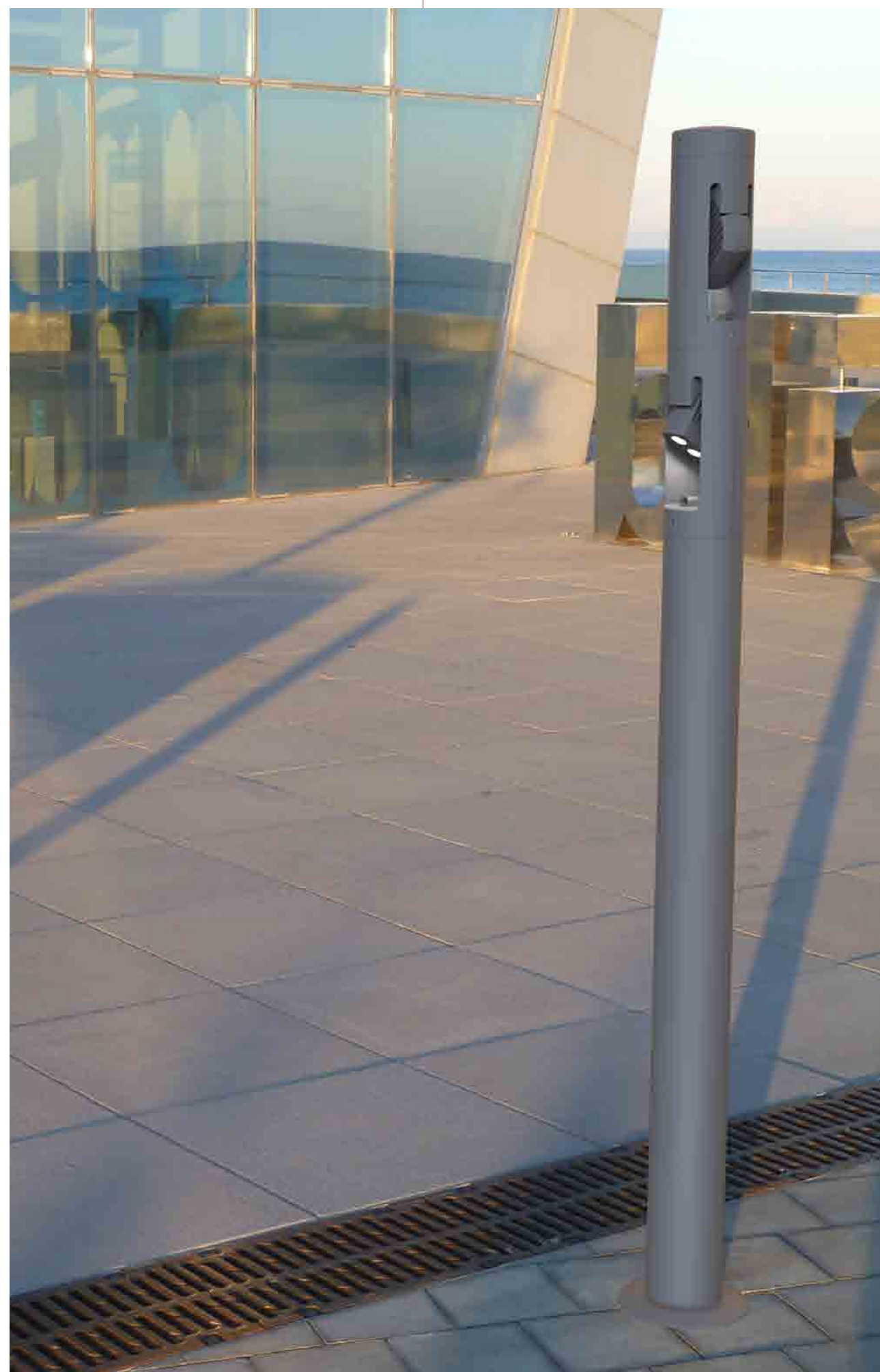
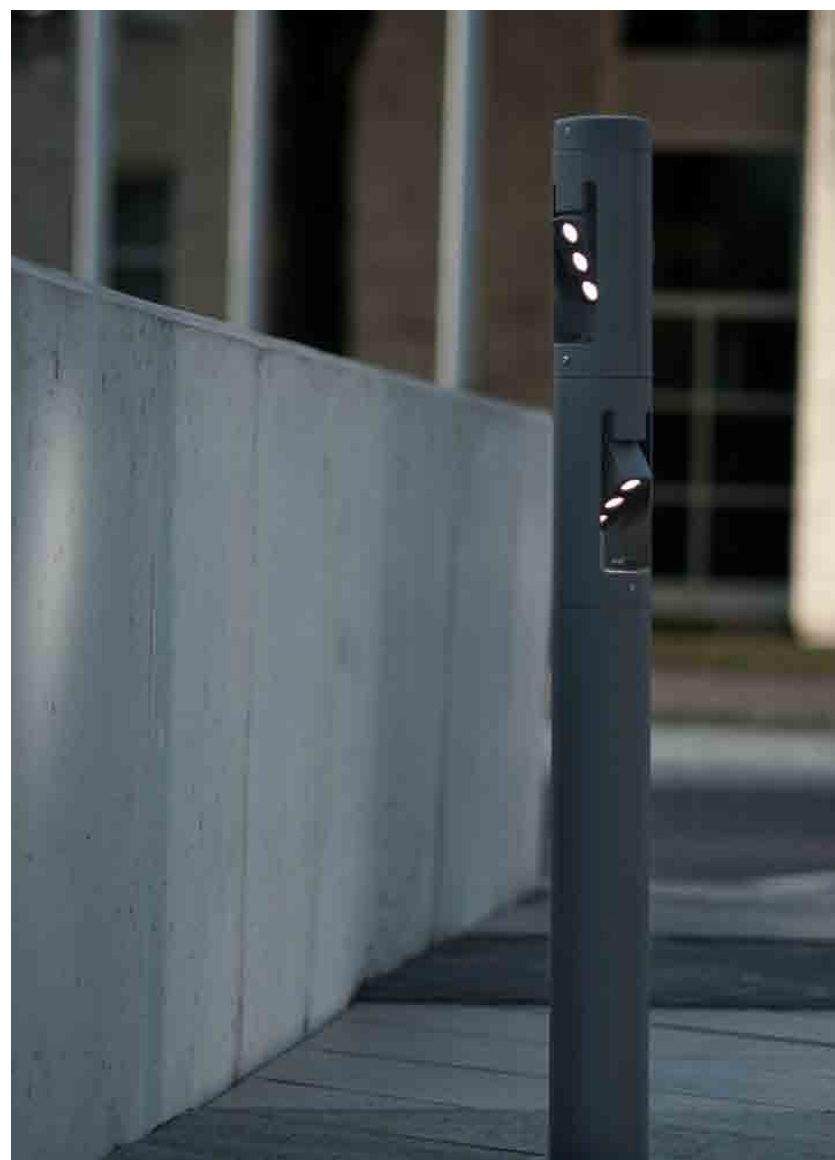

6142-1 gr

CLASS II ☐ CE
IP54
LED 9W
500 Lumen
Die Cast Aluminium

A+

4000K

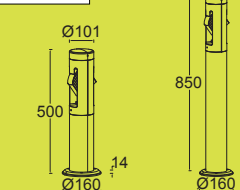

6142-1-500

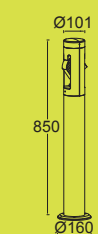

6142-1-850

6142-2 gr

CLASS II ☐ CE
IP54
LED 19W
1000 Lumen
Die Cast Aluminium

A+

4000K

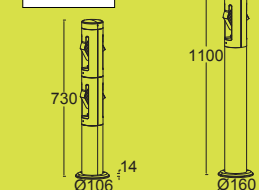

6142-2-730

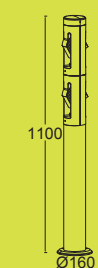

6142-2-1100

TRUMPET

wall & bollard

Accentuate your outdoor places with this minimalistic yet powerful LED wall light with moveable spotlight.



6260 gr

CLASS I CE
IP54
LED 11W
840 Lumen
Die Cast Aluminium

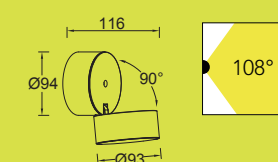

6261A-850 gr

CLASS I CE
IP54
LED 10W
850 Lumen
Die Cast Aluminium

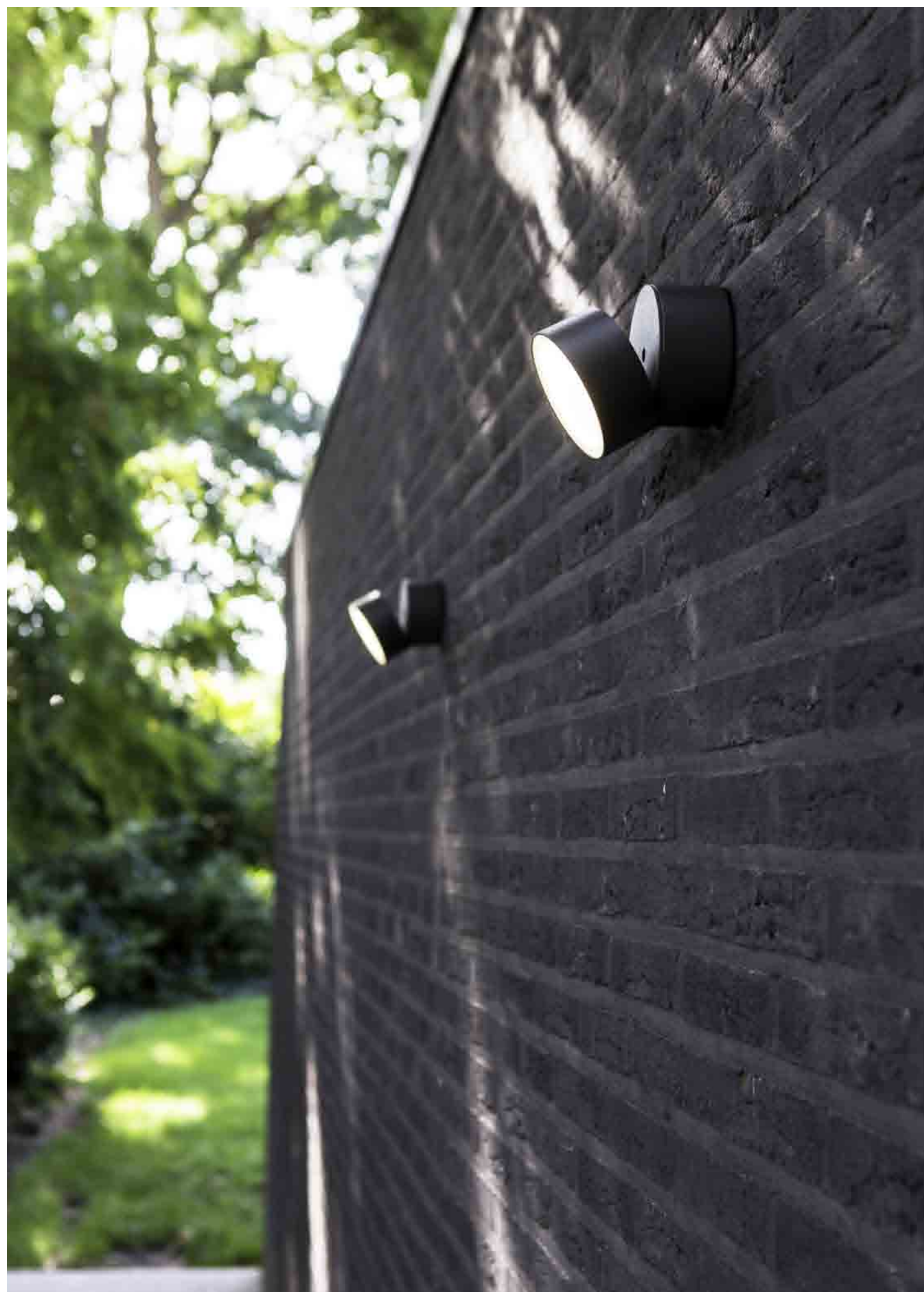
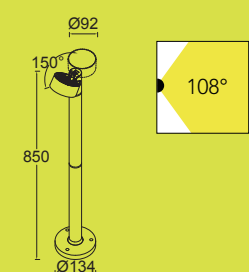

EGGO

wall

Wall light with the spot head rotating over a 100°. The multicolour feature gives this article a playful look. As an indirect light the metallic paint will function as a perfect reflector.



6160 gr

CLASS II CE
IP54
LED 9W
350 Lumen
Die Cast Aluminium

A*

4000K

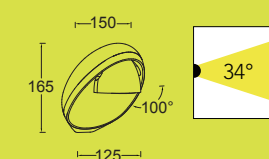

EGGO

bollard

The tubular post comes in 3 dividable parts, and gives you the opportunity to mount the article as a pedestal, a medium or high post, following the light effect you want to give in your garden.



6161-1180 gr

CLASS II CE
 IP54
 LED 9W
 350 Lumen
 Die Cast Aluminium

A+

4000K

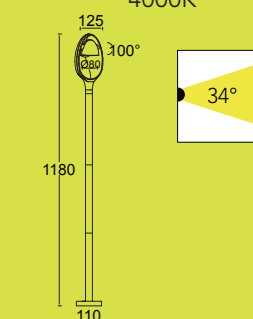

ANDA

wall

Wall light with a 1000 lumen light output, can be mounted at a certain height in order to illuminate a large area.



2521S gr

CLASS I CE
IP54
LED 18W
1040 Lumen
Die Cast Aluminium

A+

4000K

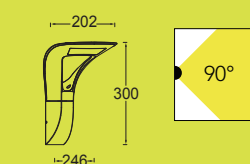

ANDA

bollard

Elegant but robust bollard which integrates well in your garden layout in a multi-installation format. The powerful light output will give a strong light but will not dazzle people passing by.

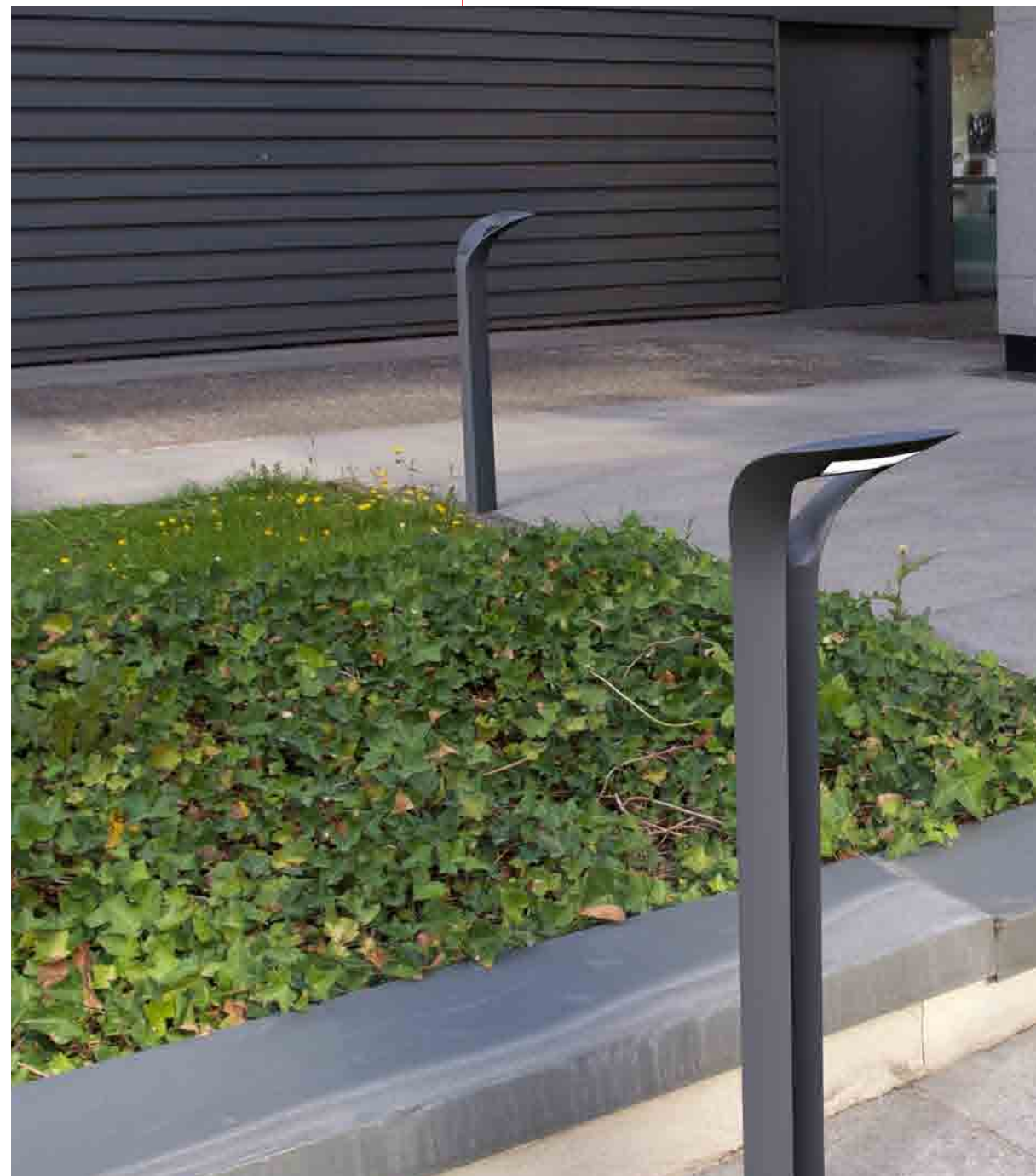

25225-800 gr

CLASS I CE
IP65
LED 18W
1040 Lumen
Die Cast Aluminium

A+

4000K

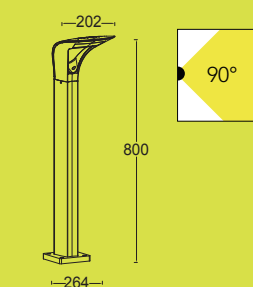

MERIDIAN

wall



Elegant combination of anthracite grey aluminium body and opal white polycarbonate diffuser. Wall light in medium & small sizes gives a strong diffused light and a design statement in your garden.



6163S-3K gr

CLASS I CE
IP54
LED 14W
800 Lumen
Die Cast Aluminium

A+

3000K

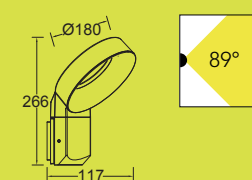

6163S-PIR-3K gr

CLASS I CE
IP54
LED 14W
800 Lumen
Die Cast Aluminium

A+

3000K

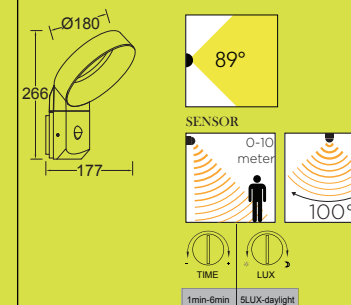

6163 gr

CLASS I CE
IP65
LED 22W
1300 Lumen
Die Cast Aluminium

A+

4000K

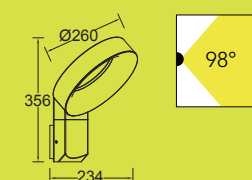

MERIDIAN

bollard

Bollard at a perfect height which gives your pathway, terrace and garden the desired atmosphere at night without any glare. The strength of the light beam can also be chosen.



6164S-730-3K gr

CLASS I CE
IP54
LED 14W
800 Lumen
Die Cast Aluminium

A+

3000K

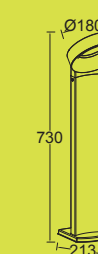

89°

6164-730 gr

CLASS I CE
IP65
LED 22W
1300 Lumen
Die Cast Aluminium

A+

4000K



98°



CONE

wall

Down light with an upward glow effect, combines a functional wall light with a decorative extra.



1877S gr

CLASS I CE
IP54
LED 9W
50 Lumen(up)
300 Lumen (down)
Die Cast Aluminium

A+

4000K

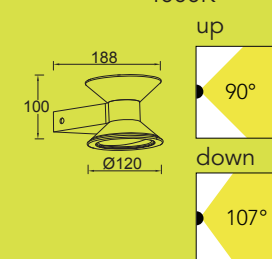



CONE

wall

Straightforward design yet solid in function offering a gentle glow. Comes also in a medium size with a more powerful light output.



1876S gr

CLASS I CE
IP54
LED 4W
260 Lumen
Die Cast Aluminium

A+

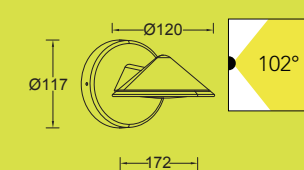

1876 gr

CLASS I CE
IP54
LED 12W
780 Lumen
Die Cast Aluminium

A+

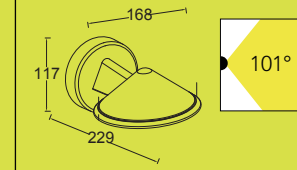

CONE

bollard

Easy to install on different surfaces. These single or double headed bollards will put your garden in a sea of light.



11876N3-800 gr

CLASS I CE
IP54
LED 12W
780 Lumen
Die Cast Aluminium

A+

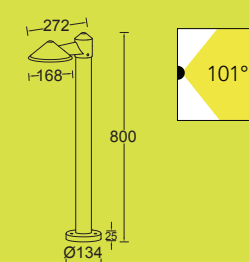

21876N3-800 gr

CLASS I CE
IP54
LED 24W
1560 Lumen
Die Cast Aluminium

A+

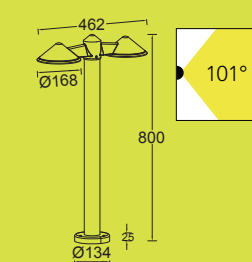

SPRIL

wall

Wall lantern giving a very wide beam of homogenous light without any glare. The circular wall washer version creates a magical lighteffect.



2253S gr

CLASS II CE
IP54
LED 8.4W
310 Lumen
Die Cast Aluminium

A+

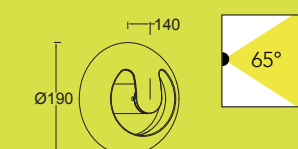

2251S gr

CLASS I CE
IP54
LED 8.4W
310 Lumen
Die Cast Aluminium

A+

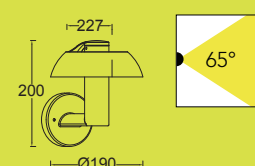

SPRIL

wall

Wall lantern giving a very wide beam of homogenous light without any glare. The ideal partner for your professional projects.



2253M gr

CLASS I CE
IP54
LED 22W
1030 Lumen
Die Cast Aluminium

A+

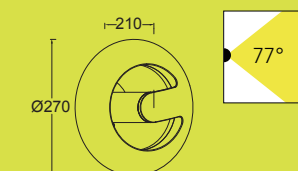

2251M gr

CLASS I CE
IP54
LED 22W
1030 Lumen
Die Cast Aluminium

A+

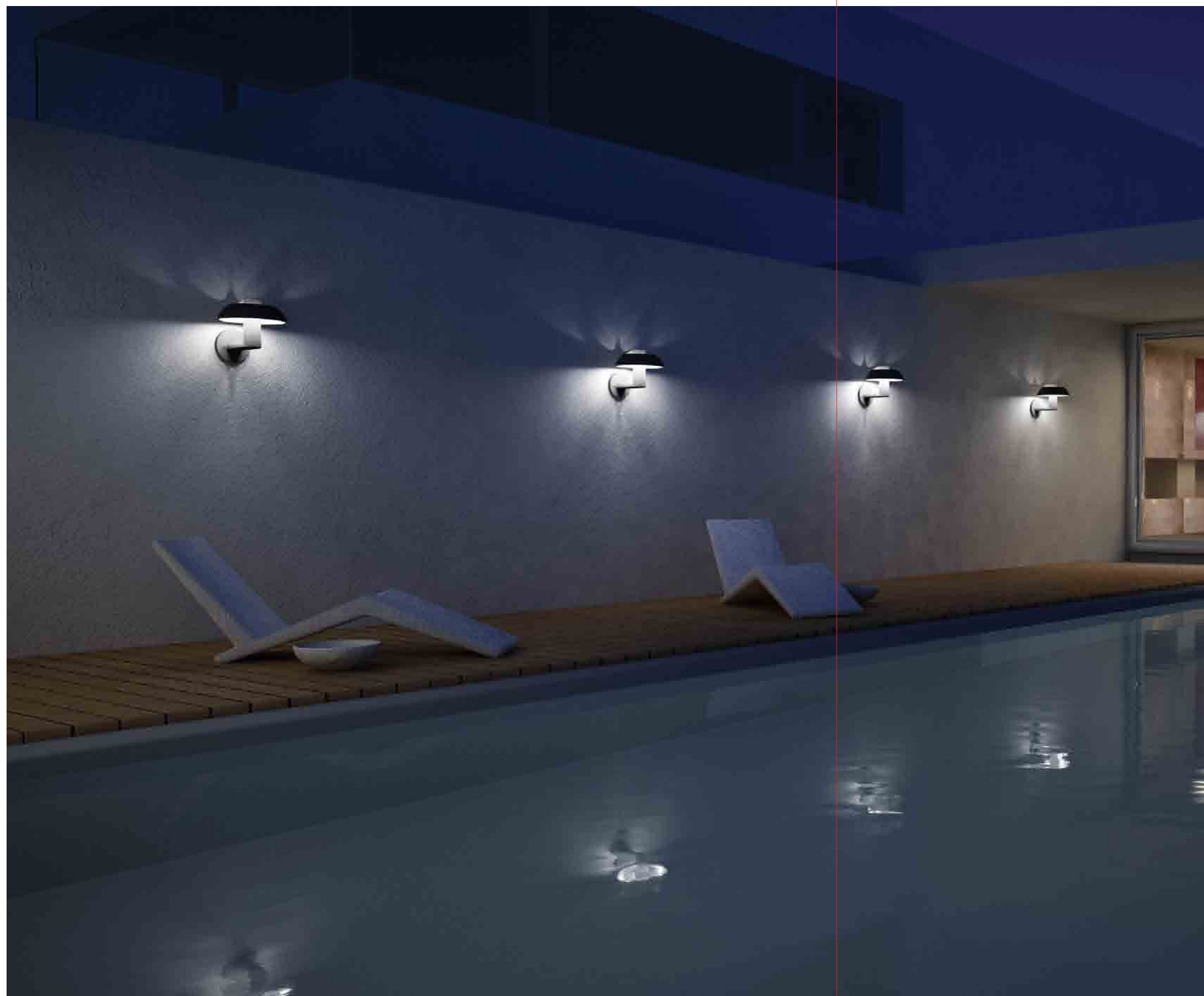
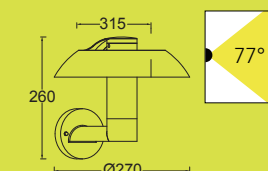

SPRIL

bollard

This series of bollards will make a style statement in your garden, combined with great functionality.



2252S-650 gr

CLASS I CE
IP54
LED 8.4W
310 Lumen
Die Cast Aluminium

A+

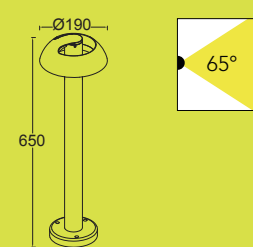

2252M-950 gr

CLASS I CE
IP54
LED 22W
1030 Lumen
Die Cast Aluminium

A+

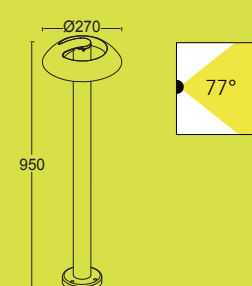

GHOST

wall

Very sleek oval design which discretely gives an indirect light, resulting in a distinctive beam pattern.



1881S gr

CLASS I CE
IP54
LED 11W
700 Lumen
Die Cast Aluminium

A+

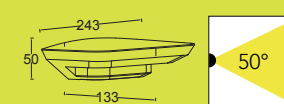

1880L gr

CLASS I CE
IP54
LED 34W
2000 Lumen
Die Cast Aluminium

A+



1880S gr

CLASS I CE
IP54
LED 7W
360 Lumen
Die Cast Aluminium

A+

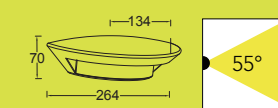

GHOST

wall

Complete round flat shape, radiating a powerful LED light over a wide area.

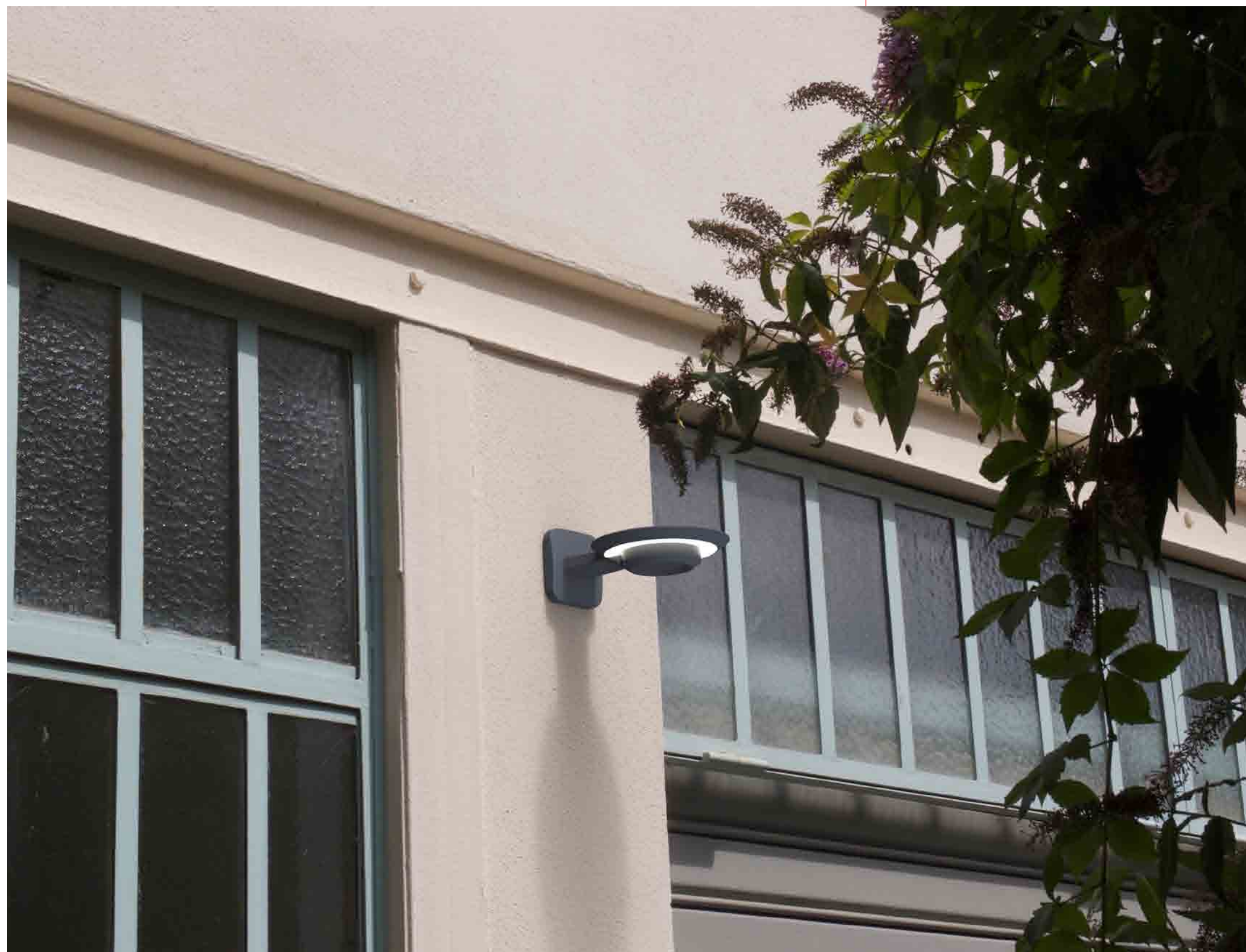

2256S gr

CLASS I CE
IP54
LED 18W
1040 Lumen
Die Cast Aluminium

A+

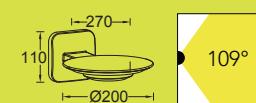

GHOST

bollard

Bollard version with the same round & flat shape, visitors will not be blinded but perfectly guided on your pathway.

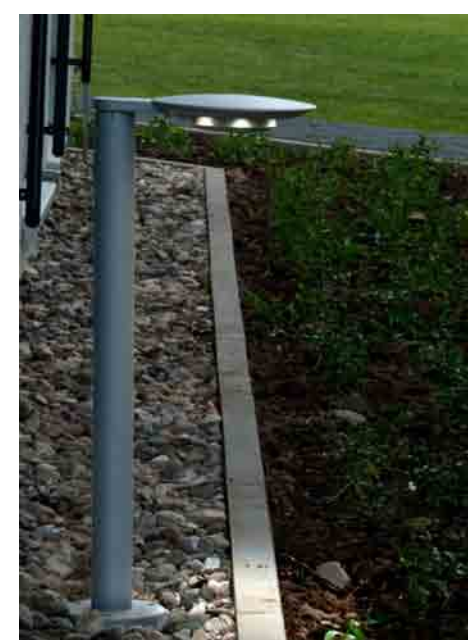
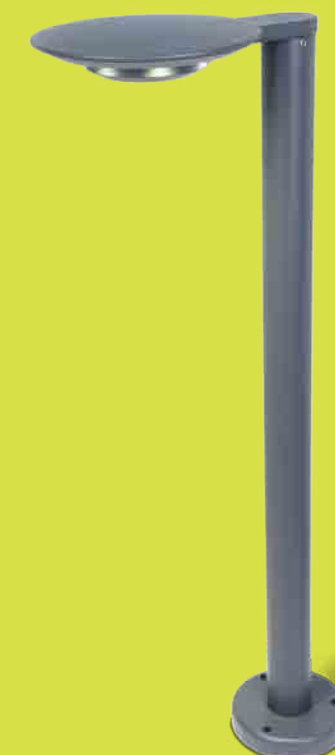
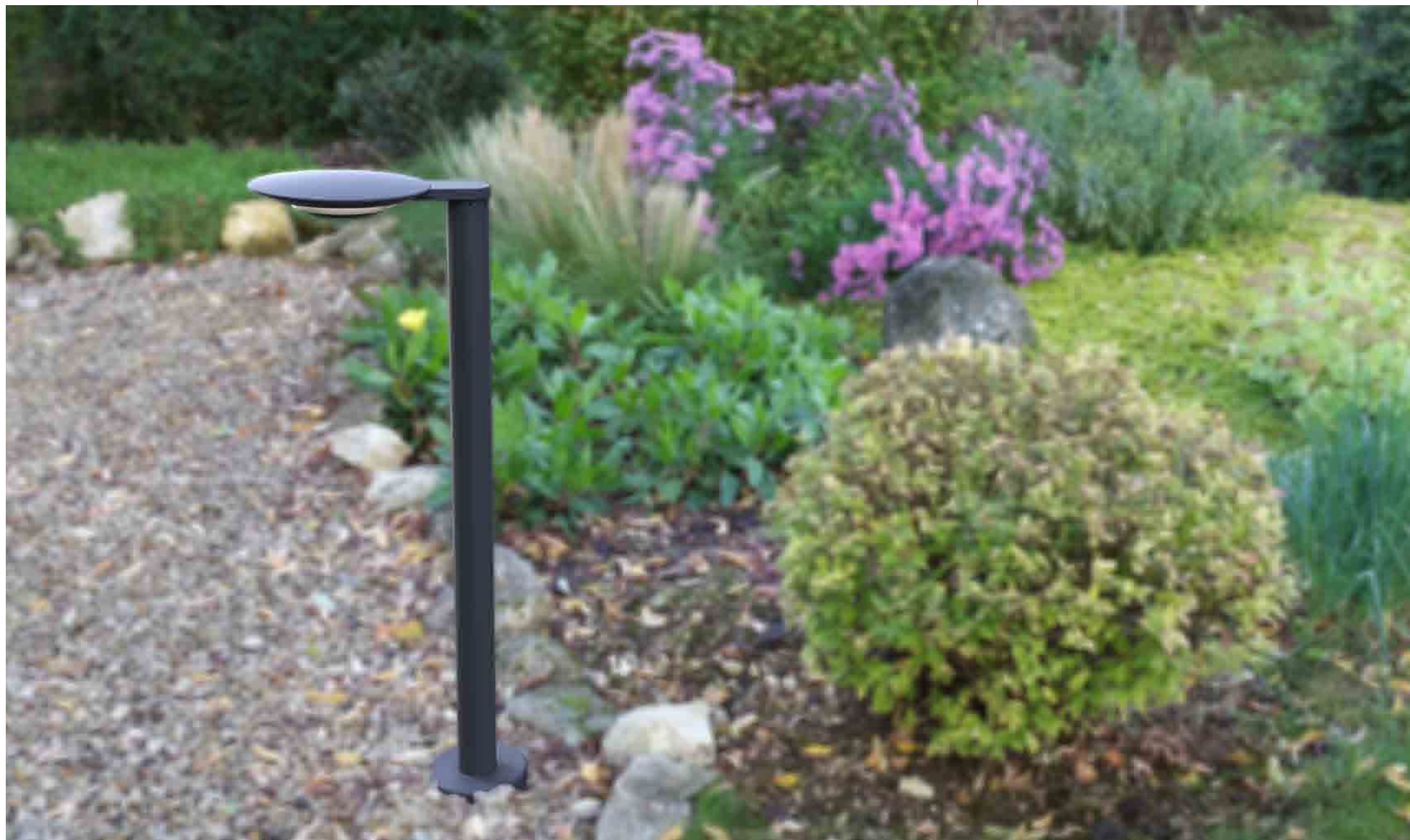

2257S-800 gr

CLASS I CE
IP54
LED 18W
1040 Lumen
Die Cast Aluminium

A+

4000K

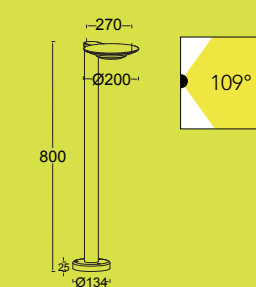

ARMOR

wall & bollard

Cube wall & bollard light with 4 die-cast aluminium corners, protecting the opal polycarbonate diffuser, but also giving a subtle design character.



6166-3K gr

CLASS I CE
IP54
LED 11W
560 Lumen
Die Cast Aluminium

A+

3000K

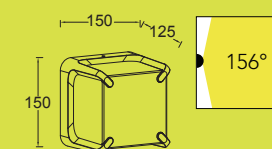

6167-600-3K gr

CLASS I CE
IP54
LED 11W
560 Lumen
Die Cast Aluminium

A+

3000K

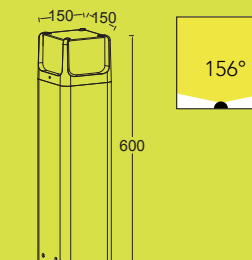

FLAT

wall & bollard

Very easy to install, first mount the stainless steel wall bracket or post and then just slide on the diffuser part.



ST031051-3K

CLASS I CE
IP44
LED 8W
500 Lumen
Stainless Steel

A+

3000K



ST031052-450-3K

CLASS I CE
IP44
LED 8W
400 Lumen
Stainless Steel

A+

3000K

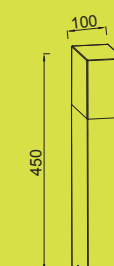

SLIM

wall



Evergreen design. Big surface frontal diffuse warm white light in combination with backlight radiation showing a gentle glow on the wall. Discrete position of the adjustable PIR motion sensor.



ST5001

CLASS II
IP44
LED 8W
270 Lumen
Stainless Steel

A+

3000K

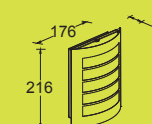

ST5001-PIR

CLASS II
IP44
LED 8W
270 Lumen
Stainless Steel

A+

3000K

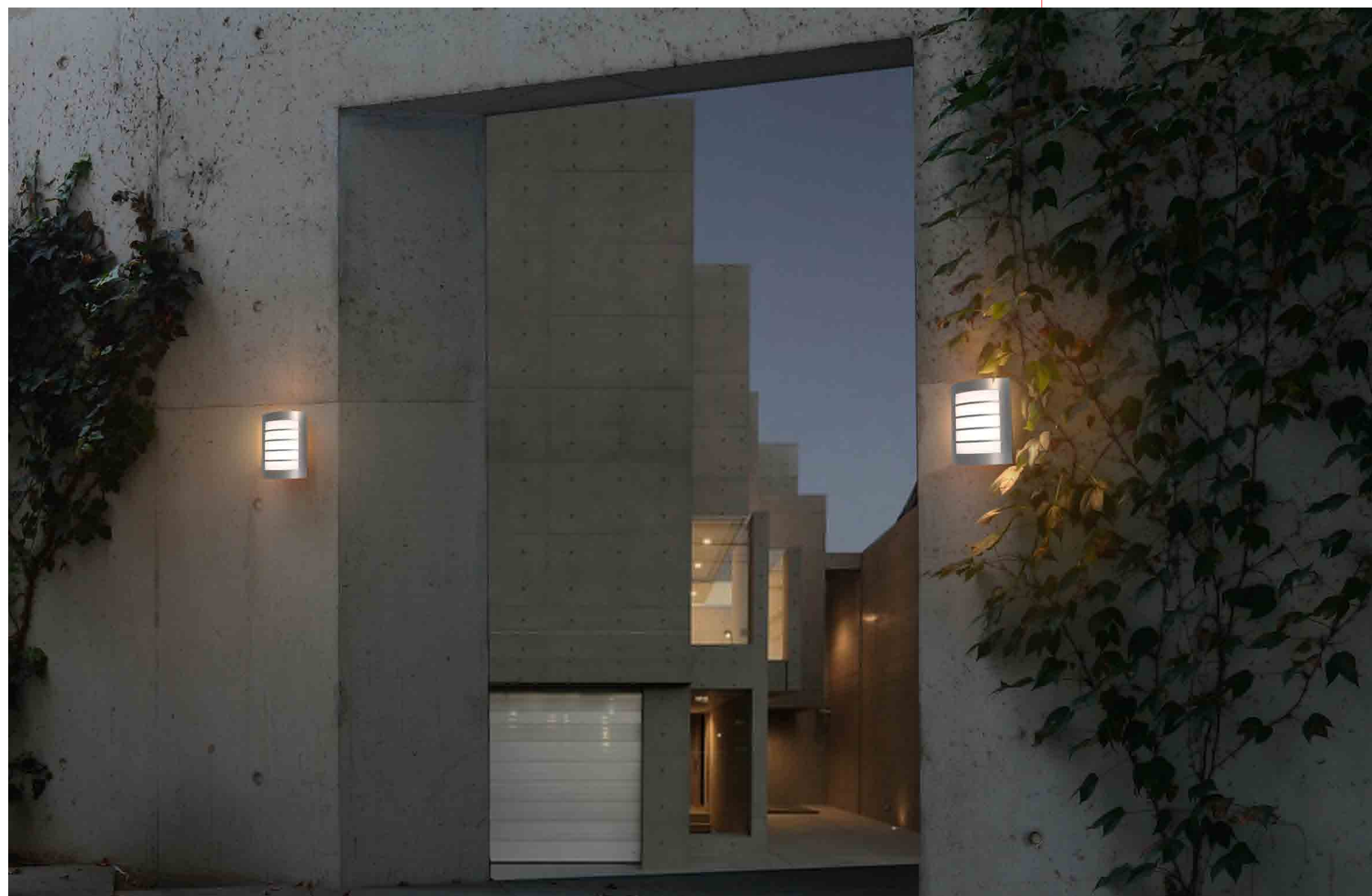
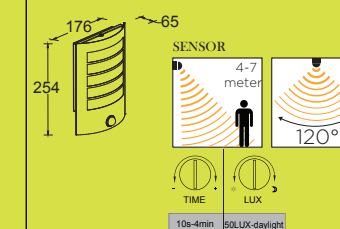

FACE

wall



Robust yet elegant stainless steel wall light, big surface diffuse warm white light radiation. Discrete position of the adjustable PIR motion sensor.



ST033071-3K

CLASS II CE
IP44
LED 13W
800 Lumen
Stainless Steel

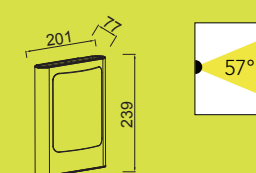

ST033071-PIR-3K

CLASS II CE
IP44
LED 13W
800 Lumen
Stainless Steel

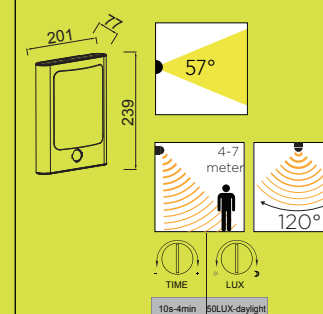
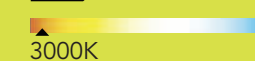

EVEN

wall & ceiling

Elegant & flat design offering a strong and homogeneous diffuse warm white LED light without any shadows.

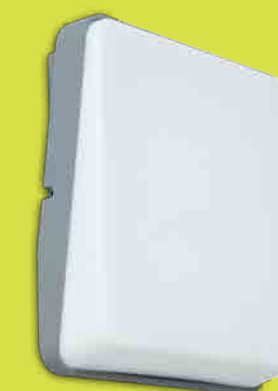

1894-3K si

CLASS I CE
IP54
LED 15W
650 Lumen
Die Cast Aluminium

A+

3000K

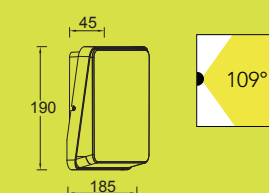

SECO

wall

The clever designed aluminum backside of this fixture, offers an easy installation. It will result aswell in a floating effect of the diffuser versus your wall.

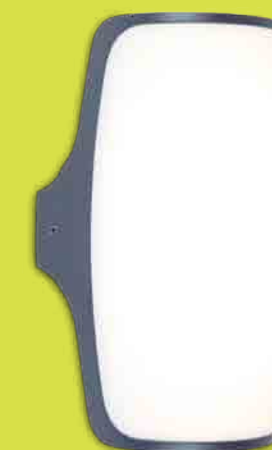

1899-3K gr

CLASS I CE
IP54
LED 8W
440 Lumen
Die Cast Aluminium

A+

3000K

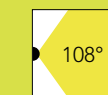

ORIGO

wall

Elegant & flat wall light giving a warm and gentle glow in 2 directions. Easy access to the connection and bulb compartment. Suitable for energy saving lamps up to 23W.



1849 gr

CLASS I CE
IP54
E27 Max.40W
Die Cast Aluminium

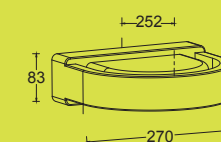

BOX CUBE

wall

Striking forms fit in all your contemporary garden spaces. The opal impact proof diffusor offers the perfect homogeneous light without any shadows. Elegant construction with no screws on the surface. The E27 Edison fitting is suitable for energy saving lamps up to 15W



1843 gr

CLASS I CE
IP44
E27 Max.60W
Die Cast Aluminium

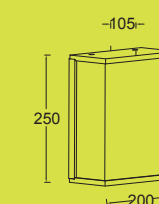

1846 gr

CLASS I CE
IP44
E27 Max.60W
Die Cast Aluminium

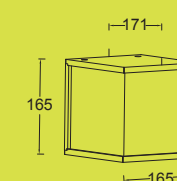

CLIP

wall

This fixture can be seen as the glow "eye" in the dark. Elegant and smart construction will accentuate the smooth line and results in an easy mounting or lamp replacement.



1853 gr

CLASS I CE
IP44
E27 Max.60W
Die Cast Aluminium

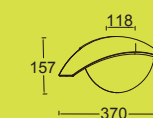

CITY

wall

Large size and robust wall light, fit to lighten large areas both in public or private places. The impact proof polycarbonate diffuser in combination with the sturdy die cast aluminum frame will make this fixture destruction proof.



1836 gr esl

CLASS I CE
IP44
E27 Max.60W
Die Cast Aluminium





DELTA

wall

Scandinavian design with focus on gentle and warm glow to create the right setting during the "Nordic" nights. The transparent PC diffuser creates a stunning pattern on your wall, both in LED integrated version as in the traditional fitting execution.



1838S-LED-3K gr

CLASS II  
IP44
LED 6W
260 Lumen
Die Cast Aluminium

A*

3000K

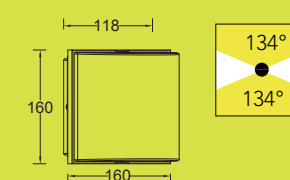

1838S gr

CLASS I 
IP44
E27 Max.60W
Die Cast Aluminium

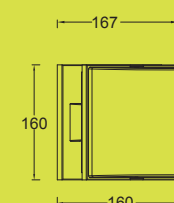

ZERTA

wall

The almost invisible "Stealth" form of this amazing wall light, houses a super powerful LED light-engine radiating a diffuse light. Best used at a certain height to light larger surfaces.



1895-3K gr

CLASS I CE
IP44
LED 30W
2090 Lumen
Die Cast Aluminium

A+

3000K

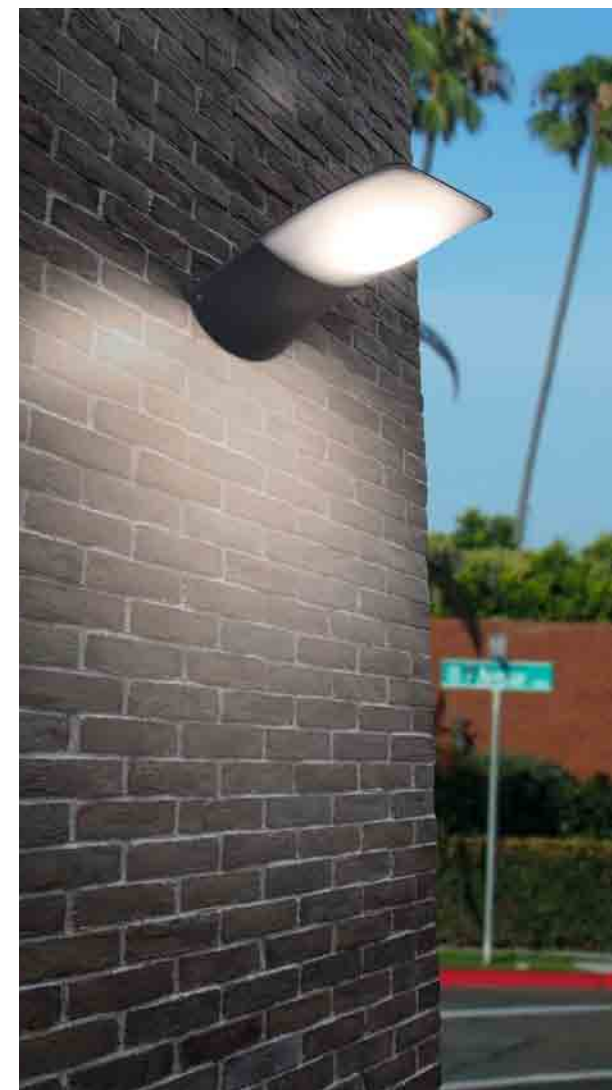
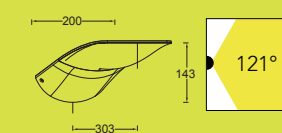

TONA

wall



Thanks to the die-cast aluminum frame in one single piece, the smooth and gracious line is accentuated. The white opal diffuser with concentric circles is giving the right direction to the light and showing a subtle decorative detail during the day. Comes also with a build-in & adjustable motion sensor.



1896-PIR-3K gr

CLASS I CE
IP44
LED 9W
600 Lumen
Die Cast Aluminium

A+

3000K

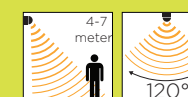
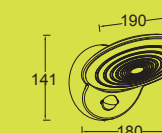

10s-4min SOLUX-daylight

1896-3K gr

CLASS I CE
IP44
LED 9W
600 Lumen
Die Cast Aluminium

A+

3000K

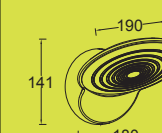

EYES

wall

Eye-catching "pacmann" form, radiating an indirect beam. No visible screws on the sleek surface in combination with a ribbed heat-ventilating aluminum base.

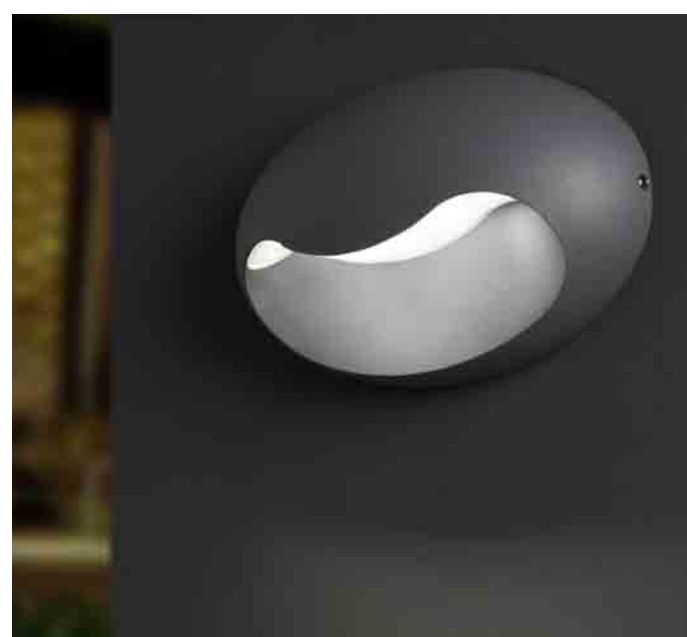
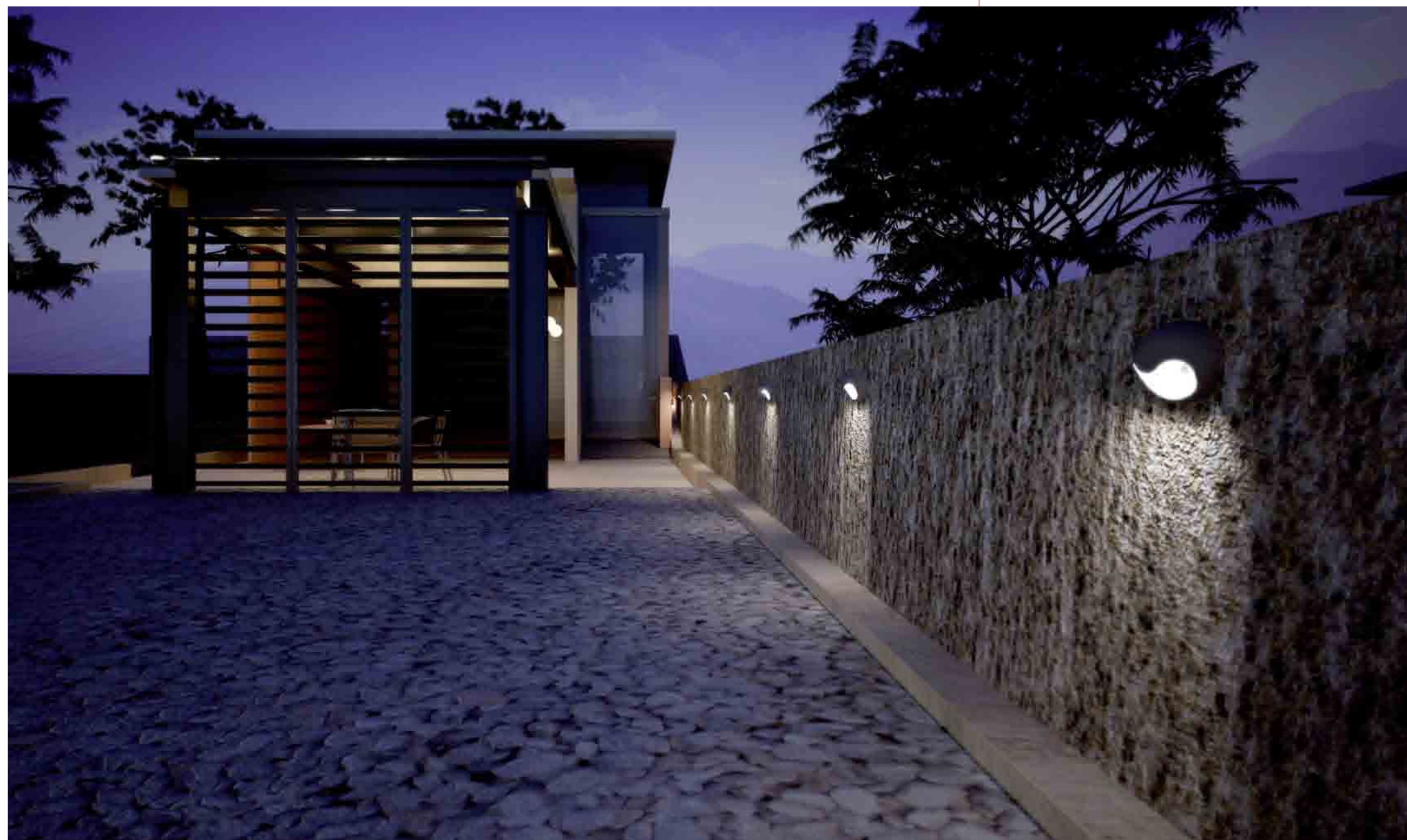

1860L gr 1860L si

CLASS I CE
IP54
LED 19W
780 Lumen
Die Cast Aluminium

A+

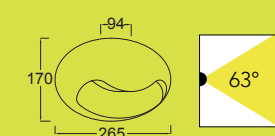

1860 gr 1860 si

CLASS I CE
IP54
LED 9W
370 Lumen
Die Cast Aluminium

A+

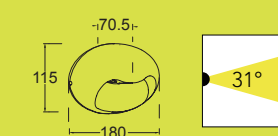

EYES

wall

Oval form wall light, elegant, compact & simple.
Easy to install in many different applications.

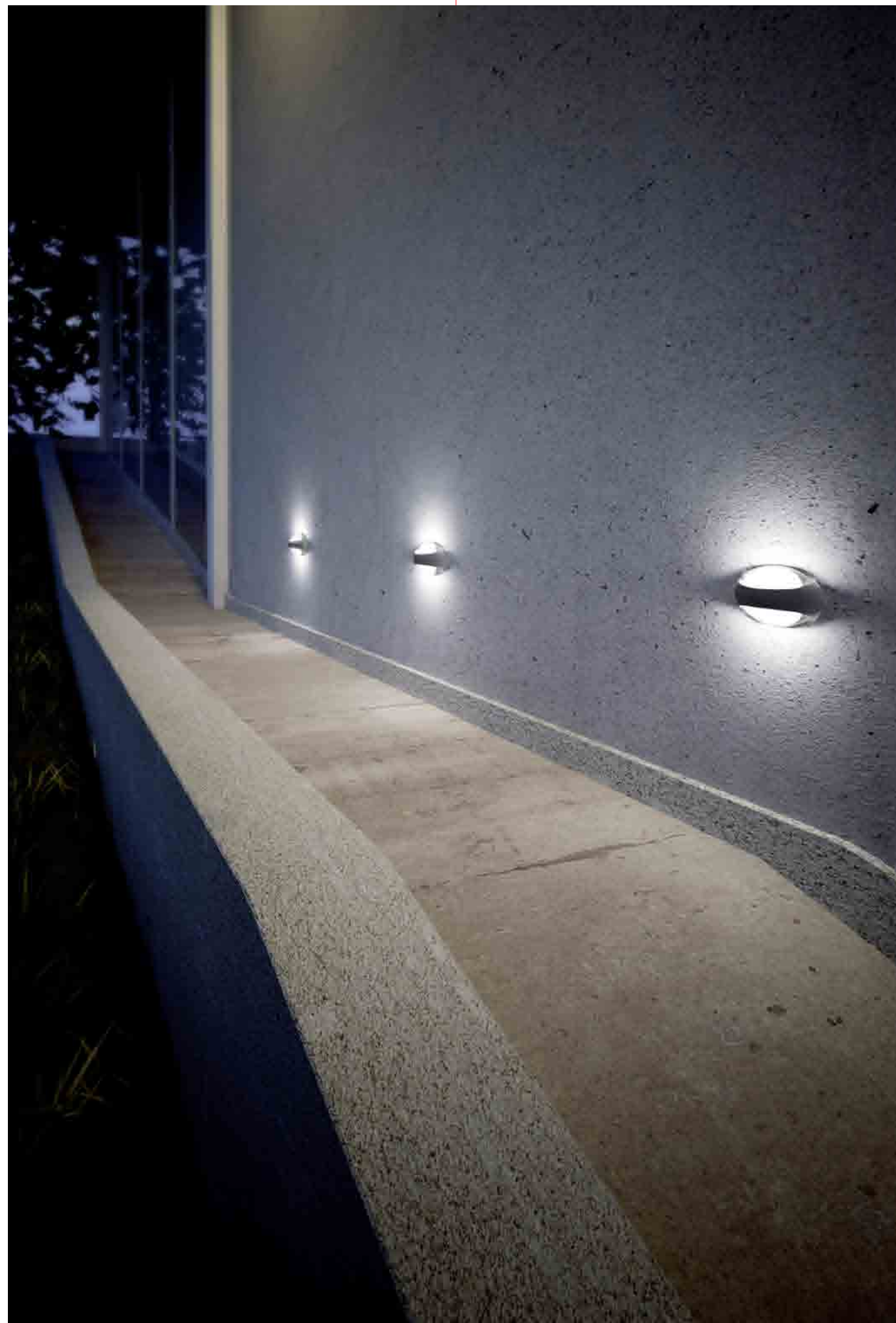

1861 gr
1861 si

CLASS I CE
IP54
LED 8.5W
310 Lumen
Die Cast Aluminium

A+

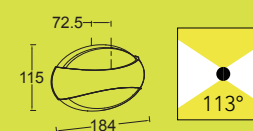

1868 gr

CLASS I CE
IP54
LED 3.9W
170 Lumen
Die Cast Aluminium

A+

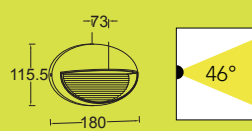

RADIUS

wall

Round & square indirect light. The invisible LED light engine, creates a subtle light effect by the reflection on the vertically ribbed anthracite or silver grey aluminum housing.



1865 gr
1865 si

CLASS I CE
IP54
LED 9W
140 Lumen
Die Cast Aluminium

A+
4000K

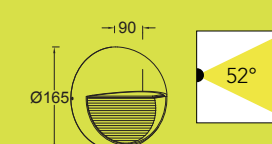

1866 gr
1866 si

CLASS I CE
IP54
LED 9W
130 Lumen
Die Cast Aluminium

A+
4000K

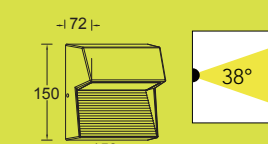

SANDWY

wall

The double light effect in the front and downwards, creating a nice beam pattern and a subtle decorative accent. The one piece die cast aluminum frame creates a sleek & elegant look.



1882 gr

CLASS I CE
IP44
LED 9W
324 Lumen
Die Cast Aluminium

A+

4000K

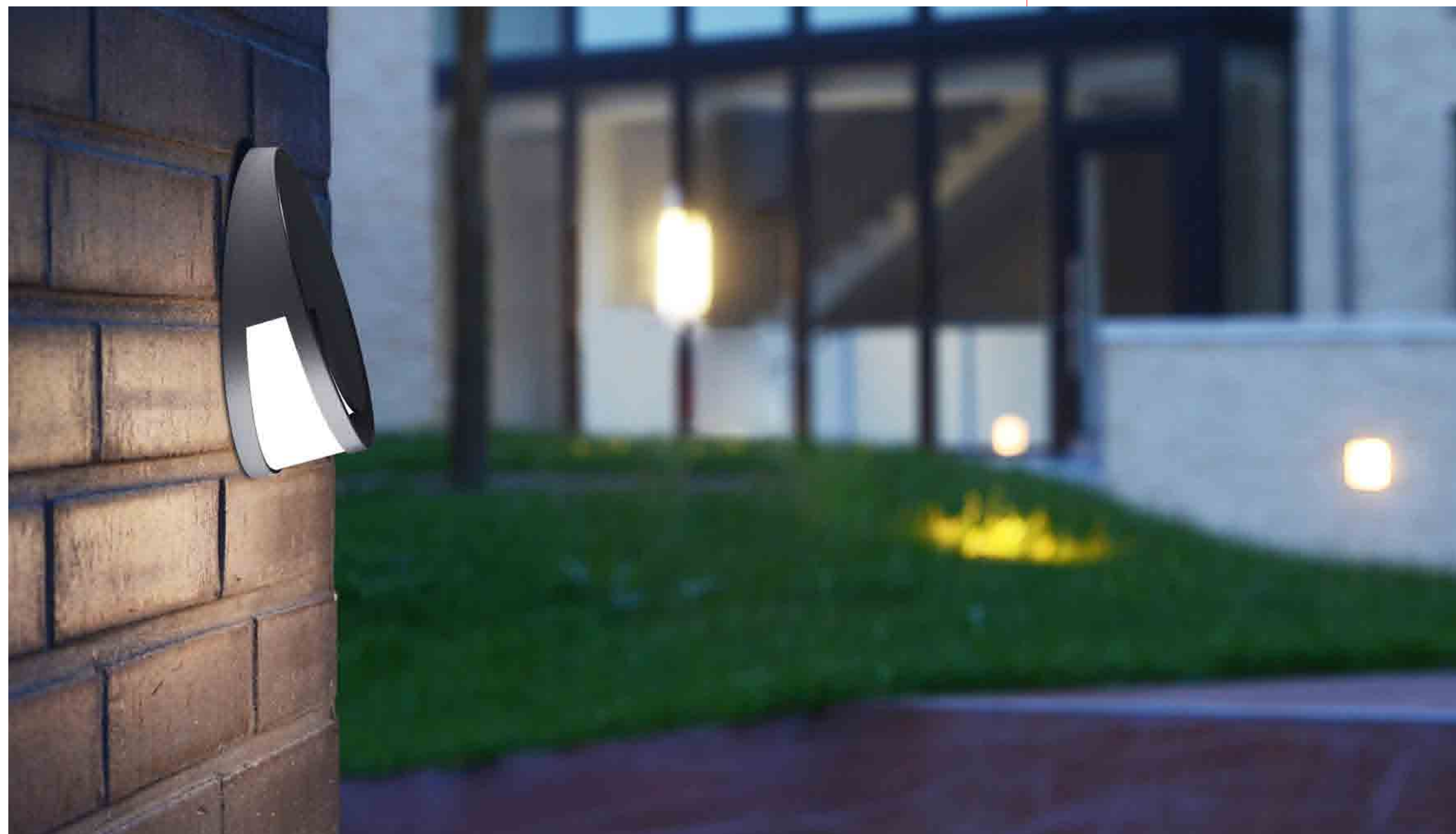
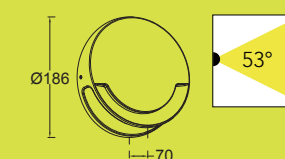

MASK

wall

Super original interpretation of a highly efficient wall washer. No visible screws on the sleek surface. Very easy mounting with a built-in water level in order to install this wall light in a perfect horizontal position.

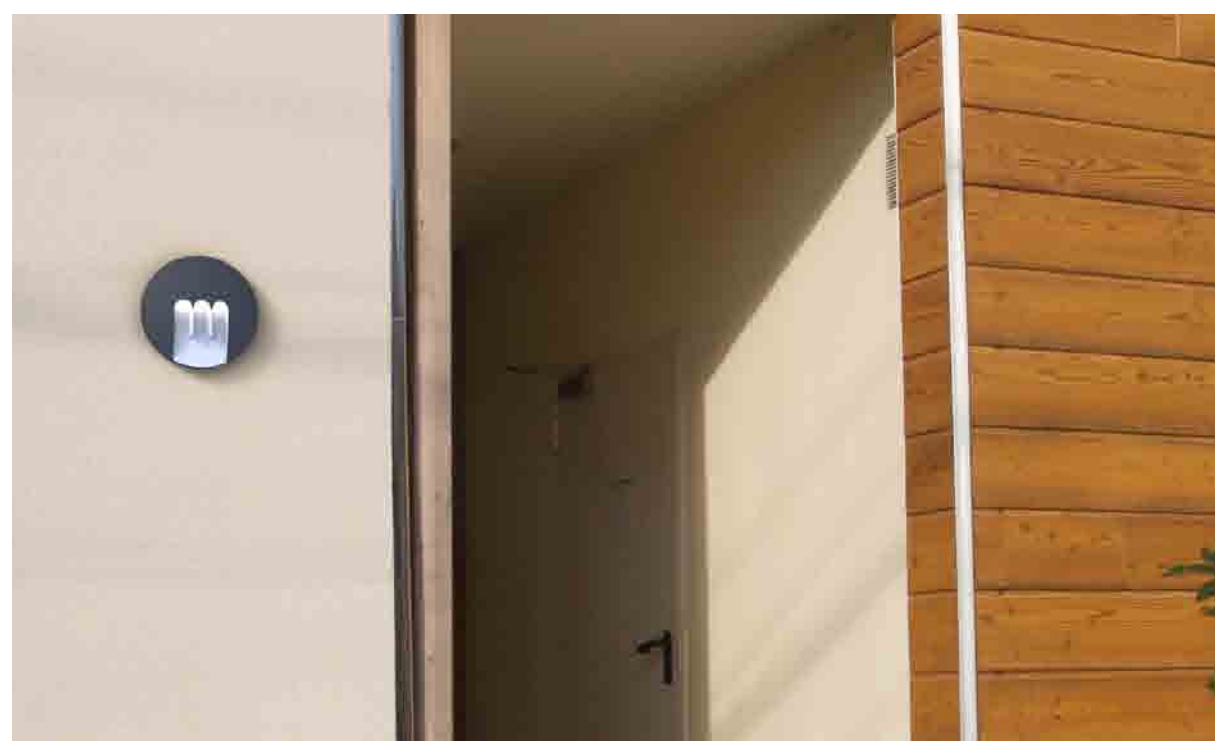

1871 gr

CLASS I CE
IP54
LED 9W
440 Lumen
Die Cast Aluminium

A+

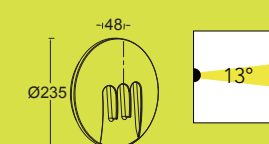

1872 gr

CLASS I CE
IP54
LED 12W
540 Lumen
Die Cast Aluminium

A+

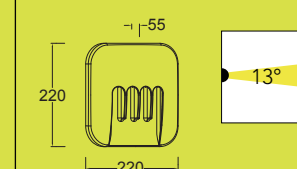

PILO

wall

Unique design radiating a glow in 4 directions, giving a distinctive light effect on your outdoor walls. Ingenious construction without any screws: the frontal aluminum cover is fixed in the right position thanks to a magnet.

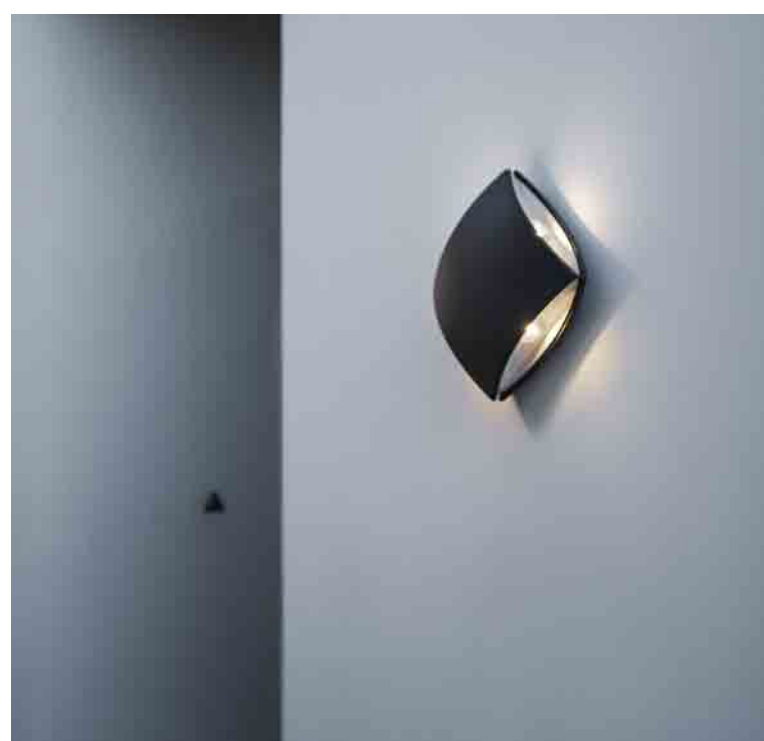
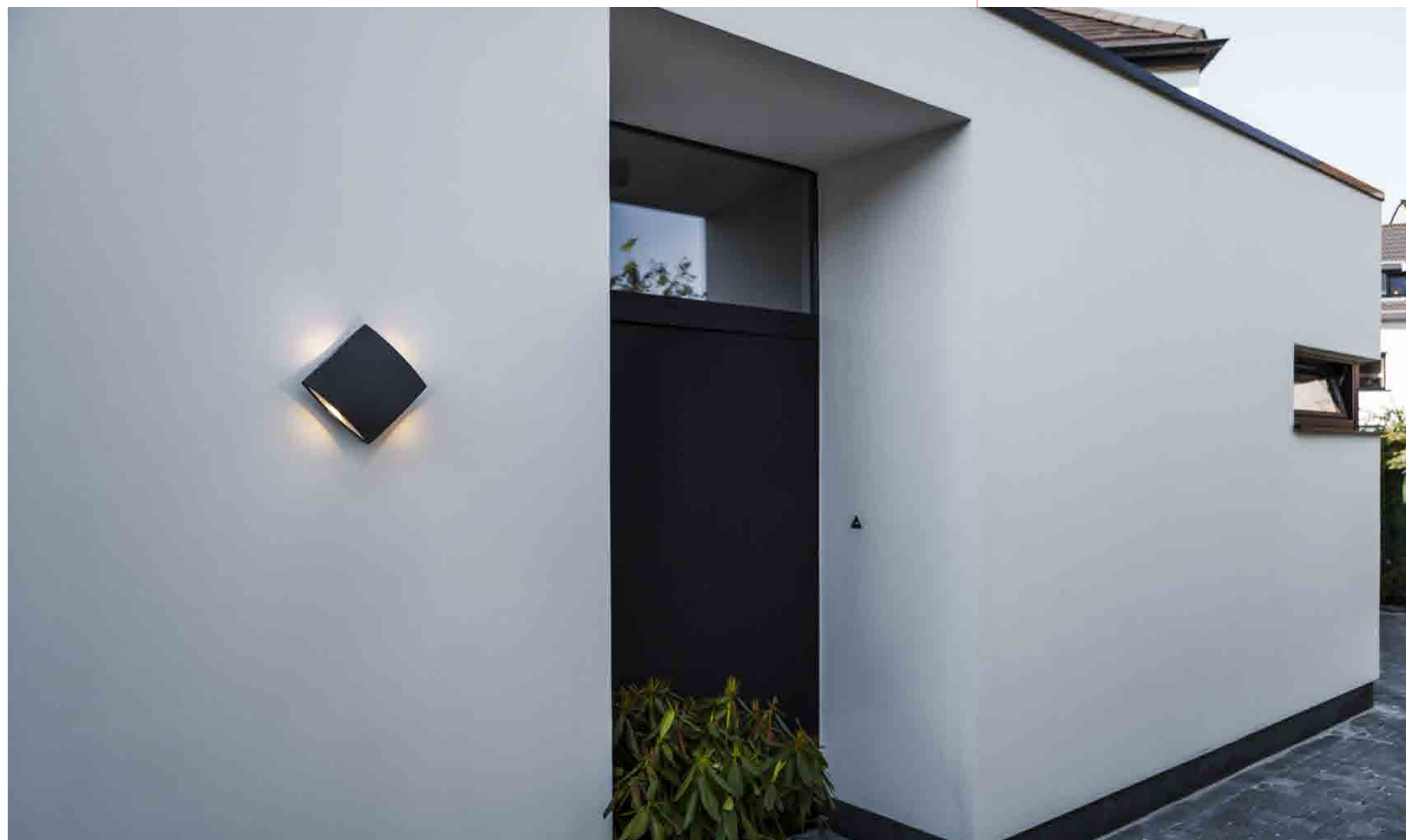

1869 gr

CLASS I CE
IP54
LED 11W
760 Lumen
Die Cast Aluminium

A+

4000K

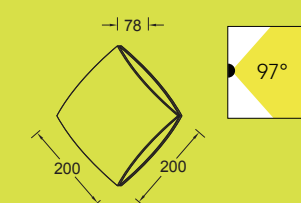

EVANS

wall

This minimalistic aluminum wall light shows a visual striking effect thanks to the use of a narrow beam lens. The square execution radiates 4 perfect "laser" beams on your wall.



1862-B2 gr

CLASS I CE
IP54
LED 6W
N:55 Lumen
W:57 Lumen
Die Cast Aluminium

A+

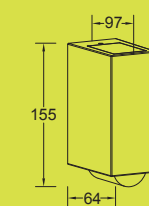

55 Lumen

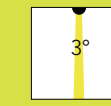

57 Lumen

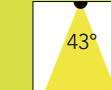

1863 gr

CLASS I CE
IP54
LED 10W
N:165 Lumen
W:57 Lumen
Die Cast Aluminium

A+

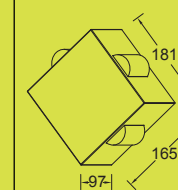

3x55 Lumen

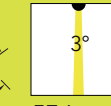

57 Lumen

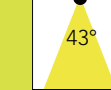

SPLIT

wall

With this elegant up & down wall light your garden will get a modern look. The distinctive ribs are showing a nice decorative detail but also suits the heat ventilation which results in a longer lifetime for the LED module. CLASS II construction makes this article safer and also suitable to use in wet indoor places like bathrooms.



1879 gr

CLASS II CE
 IP44
 LED 9W
 480 Lumen
 Die Cast Aluminium

A+

4000K

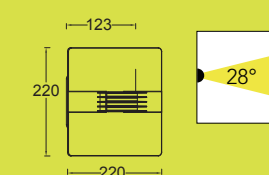

GEMINI

wall

Minimalistic design but great in light output. This elegant "brick" light in anthracite aluminum radiates a perfect bi-directional beam. The medium version is very convenient for an installation on a certain height. Thanks to the light output of more than 1200 lumen, the light beam will cover the full surface in the two directions.



1891M gr

CLASS I CE
IP54
LED 20W
1230 Lumen
Die Cast Aluminium

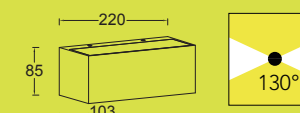

1891S gr

CLASS I CE
IP54
LED 9W
480 Lumen
Die Cast Aluminium

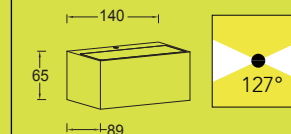

ST1891S

CLASS I CE
IP54
LED 9W
480 Lumen
Stainless Steel

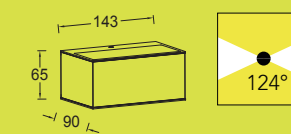

GEMINI

wall

Timeless design with a touch of quality. Up & down light with brushed premium stainless-steel cover. Small size is slim and efficient, medium size is robust and powerful.

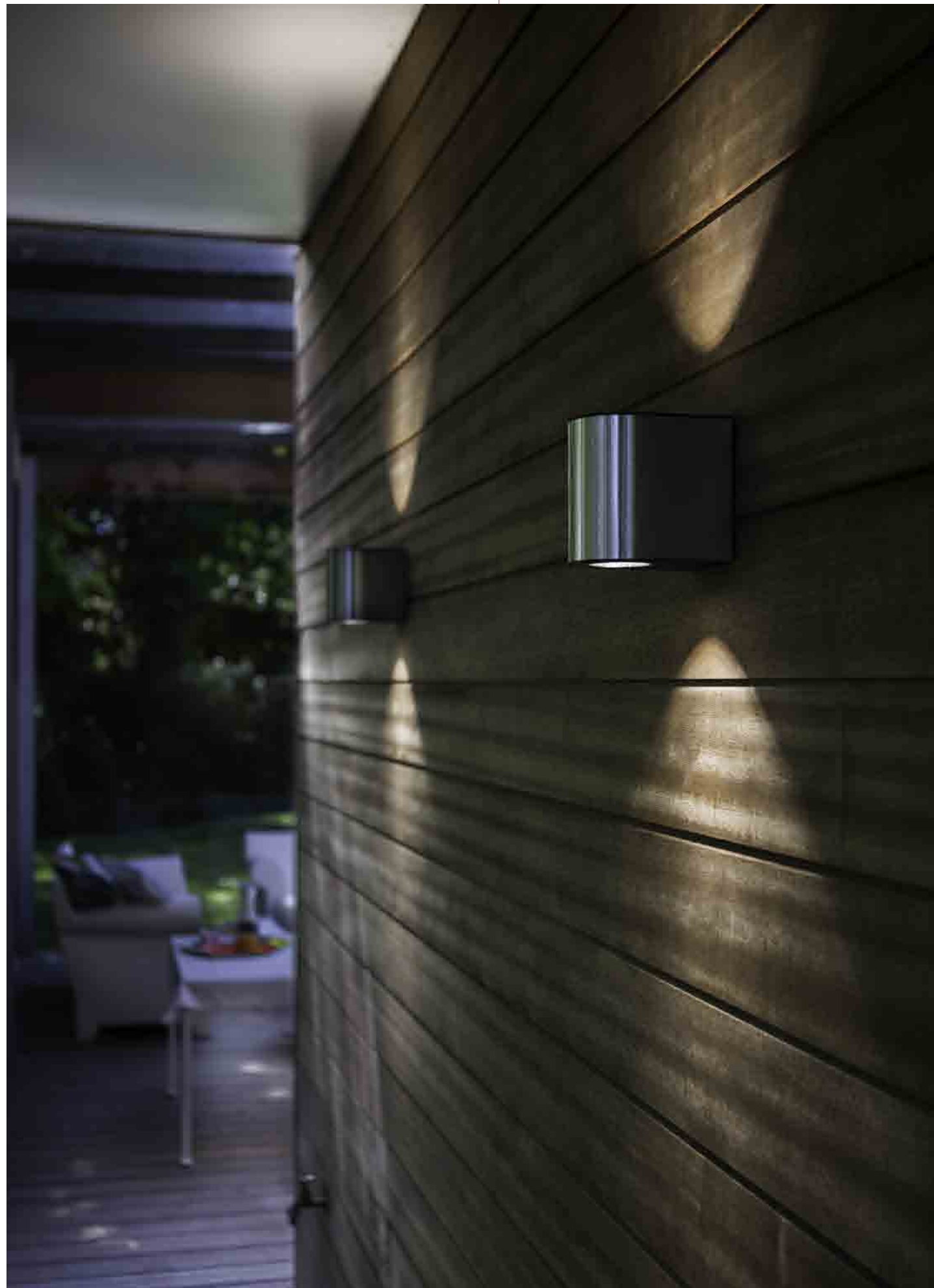
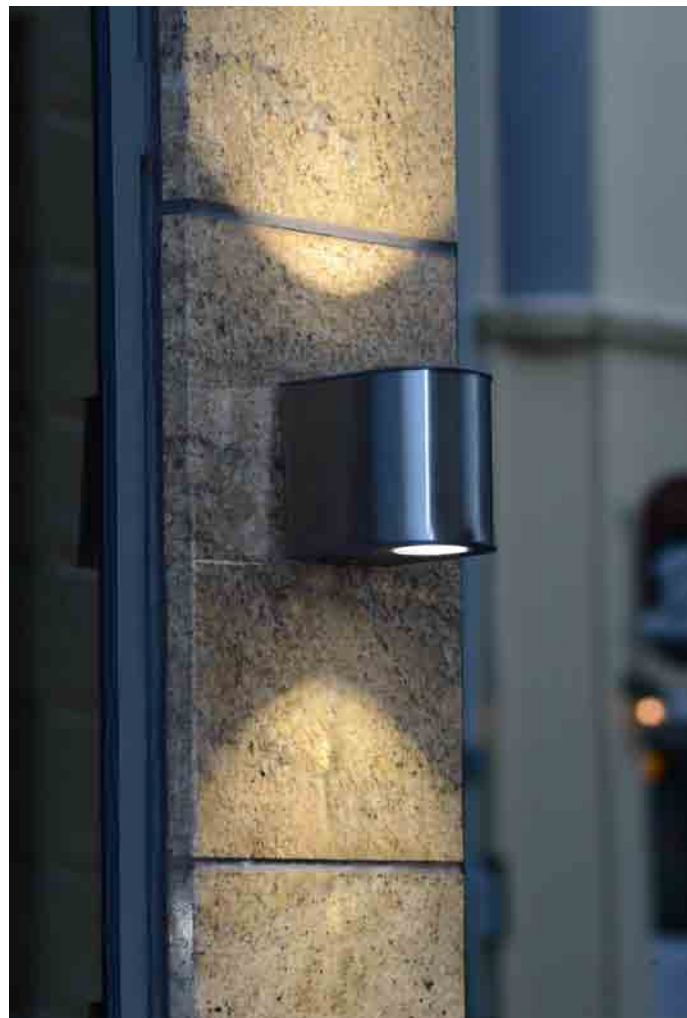

1890M

CLASS I CE
IP54
LED 24W
1240 Lumen
Stainless Steel

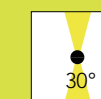
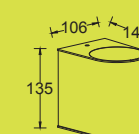

1890S

CLASS I CE
IP54
LED 9W
500 Lumen
Stainless Steel

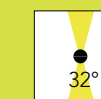
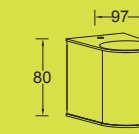

TUBE

wall

Bi-directional orientation light giving a subtle indirect light. Best used in a multiple setting. Completely open stainless steel profile with 2 frontal light lines showing a nice detail.



ST5214-3K

CLASS I CE
IP44
LED 3.7W
120 Lumen
Stainless Steel

A+

3000K

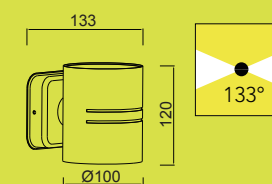

ST5215-3K

CLASS I CE
IP44
LED 3.7W
120 Lumen
Stainless Steel

A+

3000K

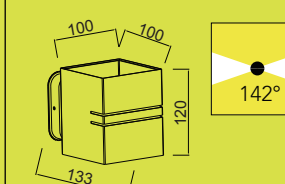

CRYSTAL

wall

Combination of brushed stainless steel housing and an optical lens, resulting in a magical and perfect aligned up & down beam pattern on your wall.

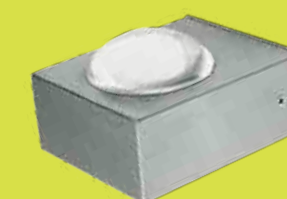
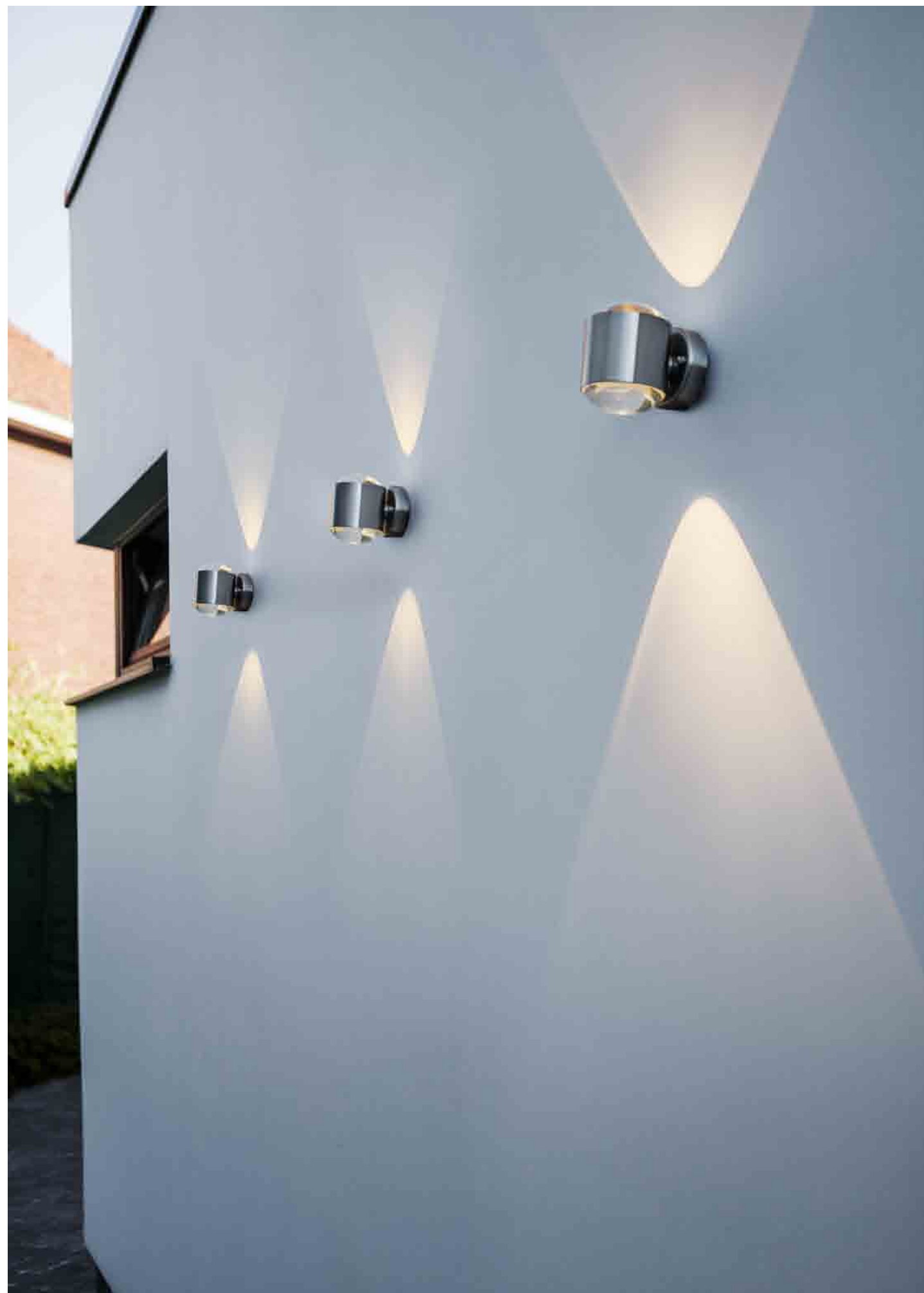

ST5212-3K

CLASS I CE
IP44
LED 10W
660 Lumen
Stainless Steel

A+

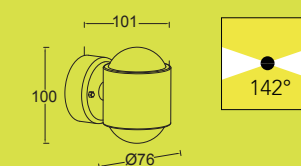

ST5216-3K

CLASS I CE
IP44
LED 10W
660 Lumen
Stainless Steel

A+

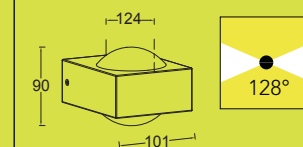

LUCA

wall

Small and straightforward Up & Down light in brushed stainless steel. Limited distance from the surface. Round & square version.



ST5108-LED-3K

CLASS I CE
IP44
LED 18W
1000 Lumen
Stainless Steel

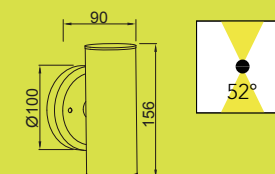

ST033023-3K

CLASS I CE
IP44
LED 11W
600 Lumen
Stainless Steel

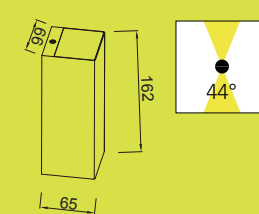

BILAYER

wall

Elegant Up & Down wall light in premium stainless steel with nice decorative glow on both sides. Comes in round & square version



ST5219-3K

CLASS I CE
IP44
LED 8W
520 Lumen
Stainless Steel

A+

3000K

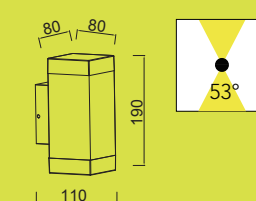

ST5218-3K

CLASS I CE
IP44
LED 8W
520 Lumen
Stainless Steel

A+

3000K

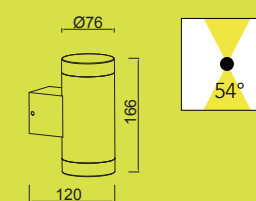

PATH

wall

Stainless steel Up & Down light with a discrete glowing part on both sides. Comes also in PIR motion-sensor version, very elegant incorporated and with a large detection reach.

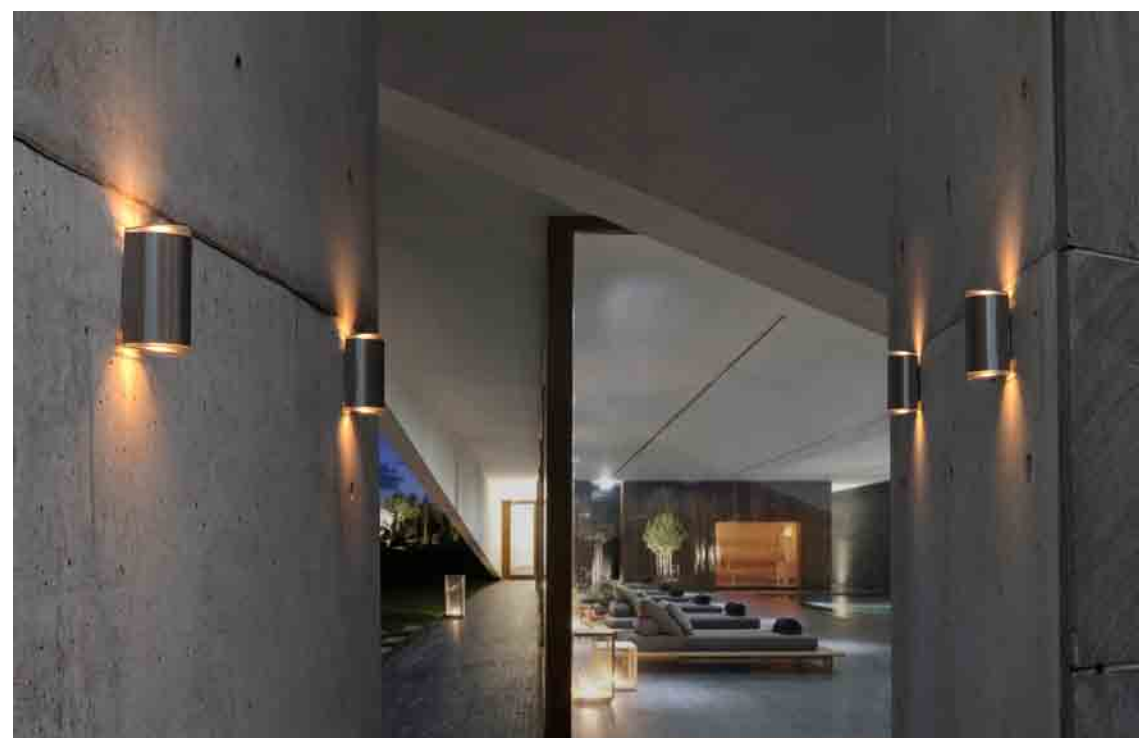
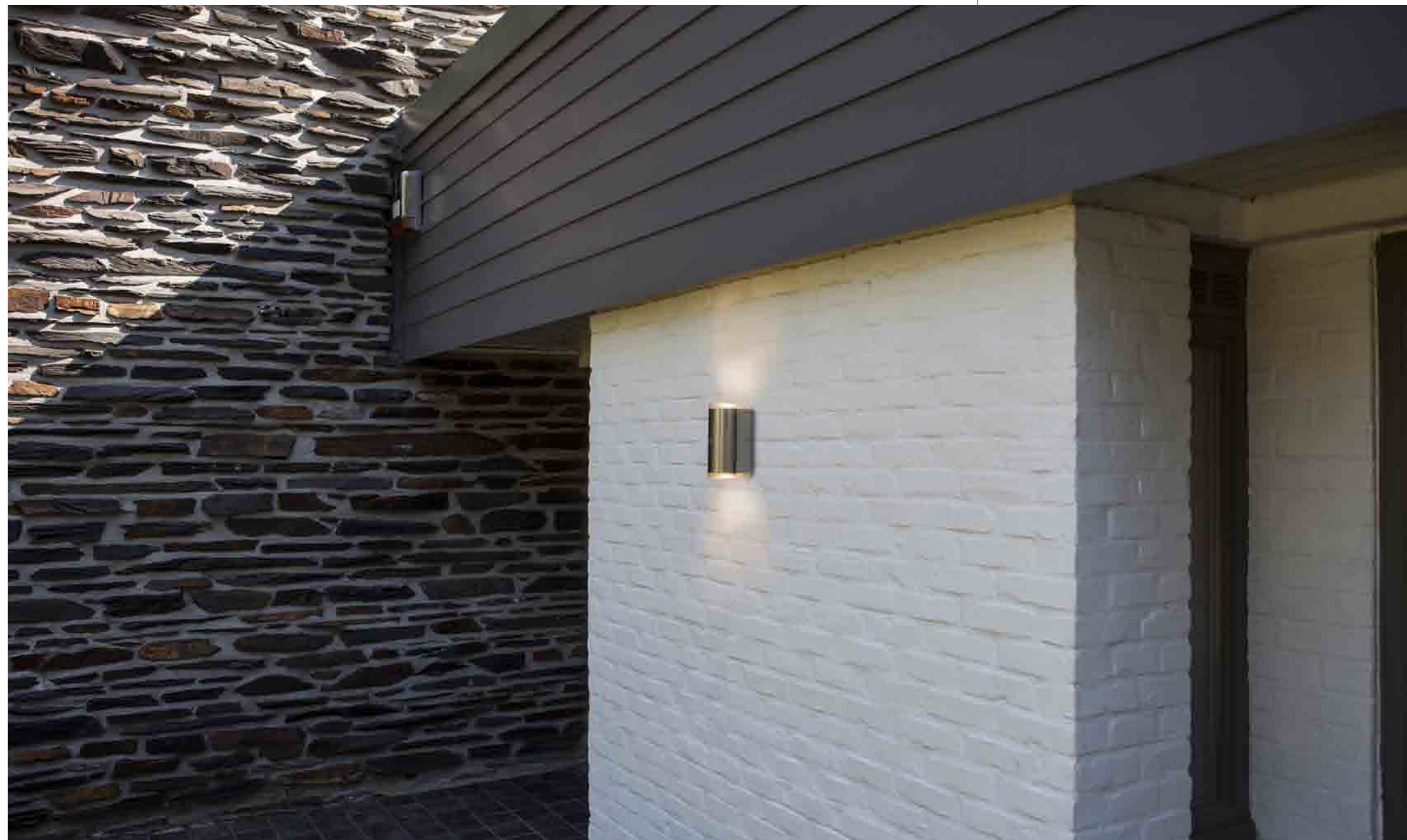

ST6057-3K

CLASS I CE
IP54
LED 15W
800 Lumen
Stainless Steel

A+

3000K

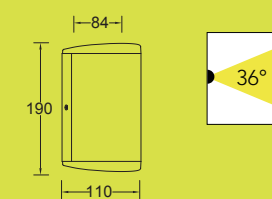

ST6057-PIR-3K

CLASS I CE
IP54
LED 16W
800 Lumen
Stainless Steel

A+

3000K

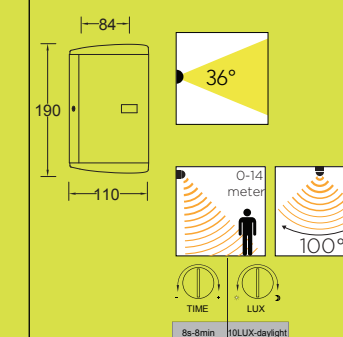

PATH

wall

Stainless steel Up & Down light with a discrete glowing part on both sides. Comes also in PIR motion-sensor version, very elegant incorporated and with a large detection reach.

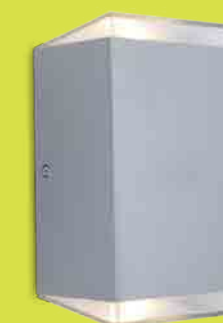

ST6058-3K

CLASS I CE
IP54
LED 15W
800 Lumen
Stainless Steel

A+

3000K

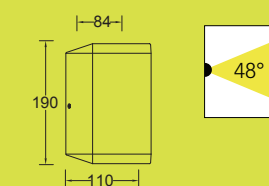

ST6058-PIR-3K

CLASS I CE
IP54
LED 16W
800 Lumen
Stainless Steel

A+

3000K

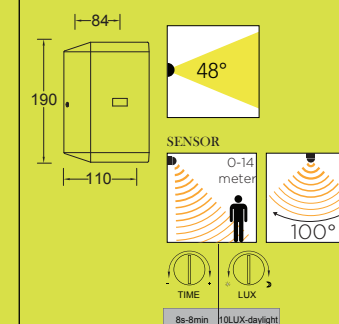

FOCUS

wall

Heavy duty die-cast aluminum versions available in anthracite & silver-grey color in combination with clear glass diffusers, giving a robust construction and a perfect light radiation both functional as decorative.



6040 gr
6040 si

CLASS I CE
IP44
GU10 2*35W
Die Cast Aluminium

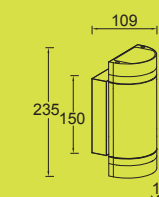

6041 gr
6041 si

CLASS I CE
IP44
GU10 35W
Die Cast Aluminium

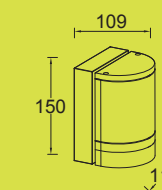

FOCUS

ceiling & bollard

Cylindrical versions with the very typical single or double horizontal light glow. This range is equipped with a traditional GU10 fitting and are suitable for halogen bulbs as well for retrofit LED bulbs.



6042 gr
6042 si

CLASS I ☼
IP44
GU10 35W
Die Cast Aluminium

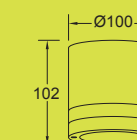

6048 gr

CLASS I ☼
IP44
GU10 35W
Die Cast Aluminium

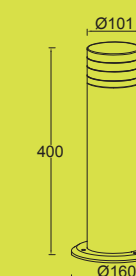

FOCUS

wall

Square execution in die-cast aluminum, with an integrated LED engine comes in a downlight version and in an up & down light version.



6050 LED gr

CLASS I CE
IP44
LED 7.6W
300 Lumen
Die Cast Aluminium

A+

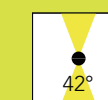
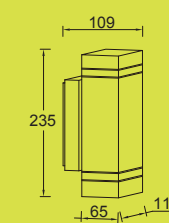

6051 LED gr

CLASS I CE
IP44
LED 3.8W
150 Lumen
Die Cast Aluminium

A+

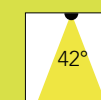
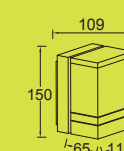

FOCUS

wall

Round shapes in premium stainless steel showing a soft & shiny appearance. The correct position of the LED engine will guarantee the perfect light pattern for this wall washer.

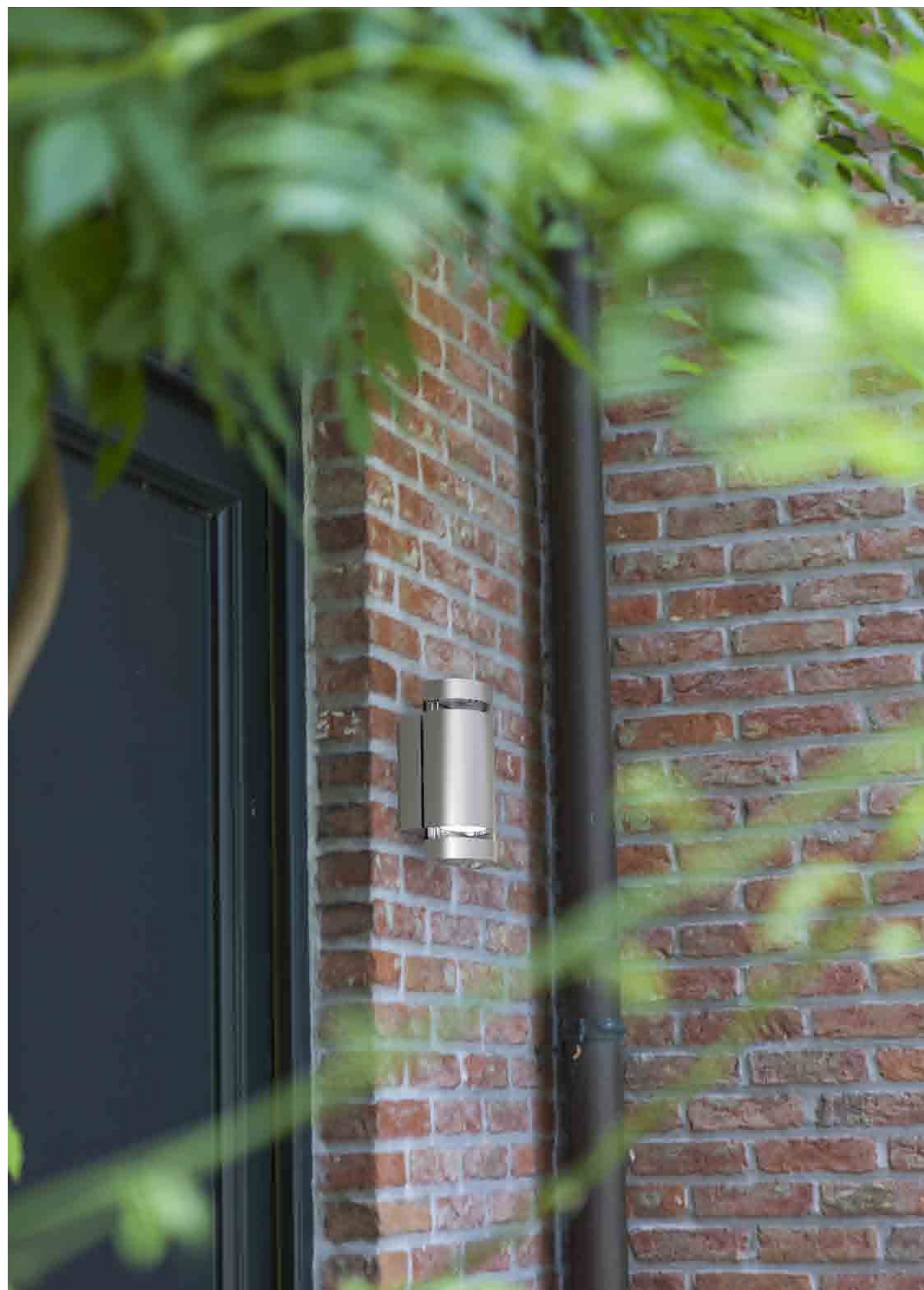

ST6040 LED

CLASS I CE
IP44
LED 7.6W
280 Lumen
Stainless Steel

A+

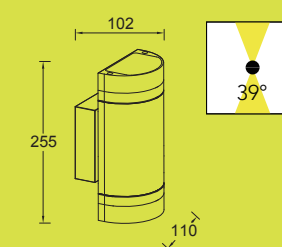

ST6041 LED

CLASS I CE
IP44
LED 3.8W
140 Lumen
Stainless Steel

A+

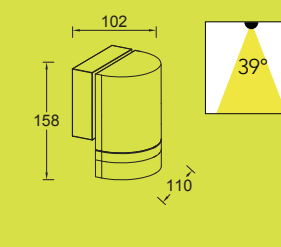

FOCUS

wall

This square execution giving a more rigid and functional look. Thanks to the LED module there will be no heat issues in this flat design, resulting in a long lifetime without any issues about replacing of the light sources.

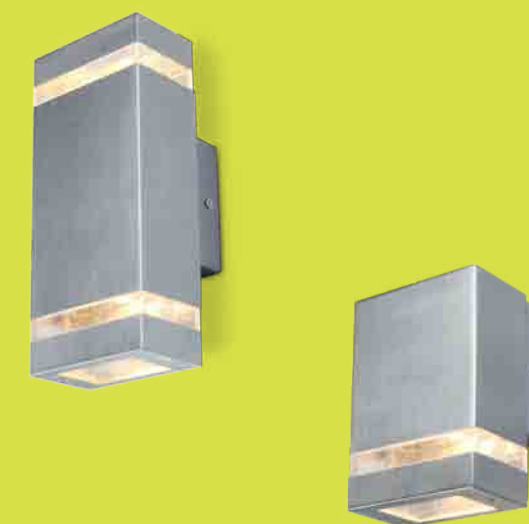

ST6050 LED

CLASS I CE
IP44
LED 7.6W
300 Lumen
Stainless Steel

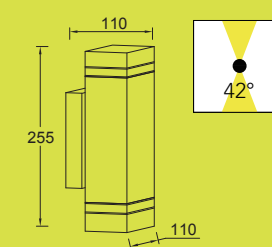

ST6051 LED

CLASS I CE
IP44
LED 3.8W
150 Lumen
Stainless Steel

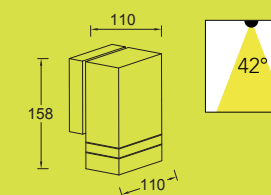

Tradition



Tradition

Revisiting the traditional lantern theme with LED integrated versions. Matching with all kind of traditional homes & surroundings: Classic, Vintage, Cottage. Invisible light sources creating a magical glow. The versions with an EDISON fitting are perfectly suitable for the newest "vintage"-LED bulbs resulting in a perfect match between new technology and authentic style.

**wall
ceiling
bollards
poles**



TRADITION

WALL



NEW

2401S ZOE / P116



NEW

2612S POSI / P118



2601 UNITE / P120



2601-PIR UNITE / P120



2602 UNITE / P120



2631S LADI / P124



NEW

1857 STARRY / P126



NEW

2411 HOM / P128



2502 CANDLE / P130



NEW

2642 CATE / P132



NEW

2592 JADE / P134

BOLLARD



2604 UNITE / P122



12603H4 UNITE / P122



NEW

12642H4 CATE / P132



NEW

32642AF4 CATE / P132

ZOE

wall

Compact, vintage look lantern. Fits in all traditional surroundings. Incorporated LED tile radiates a gentle & warm light.



2401S-3K bl

CLASS I CE
IP54
LED 9W
330 Lumen
Die Cast Aluminum

A+

3000K

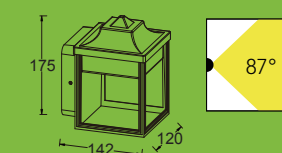

POSI

wall

Evergreen 4 face traditional aluminum lantern, executed with a highly efficient and long lasting LED engine. Radiating a diffuse & cozy warm white light.



2612S-3K bl

CLASS I CE
IP44
LED 9W
440 Lumen
Die Cast Aluminium

A+

3000K

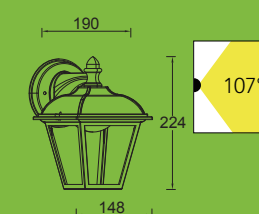

UNITE

wall

Complete collection, up & down lantern, pedestal and small post all in heavy duty die-cast aluminum and a transparent impact proof polycarbonate diffuser. The warm white light gives a cozy and traditional aspect.



2601-3K bl

CLASS I CE
IP44
LED 6.5W
260 Lumen
Die Cast Aluminium

A+

3000K

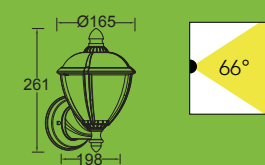

2601-PIR-3K bl

CLASS I CE
IP44
LED 9W
220 Lumen
Die Cast Aluminium

A+

3000K

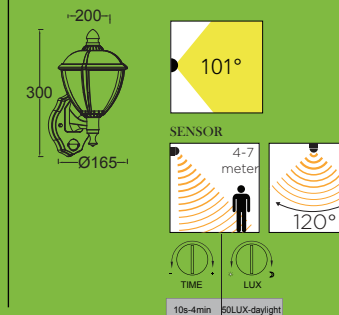

2602-3K bl

CLASS I CE
IP44
LED 6.5W
270 Lumen
Die Cast Aluminium

A+

3000K

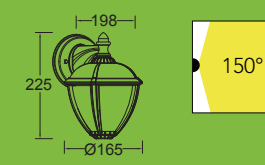

UNITE

bollard

Complete collection, up & down lantern, pedestal and small post all in heavy duty die-cast aluminum and a transparent impact proof polycarbonate diffusor. The warm white light gives a cozy and traditional aspect.



2604-3K bl

CLASS I CE
IP44
LED 6.5W
260 Lumen
Die Cast Aluminium

A+

3000K

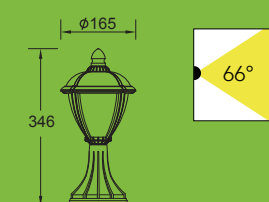

12603H4-3K bl

CLASS I CE
IP44
LED 6.5W
260 Lumen
Die Cast Aluminium

A+

3000K

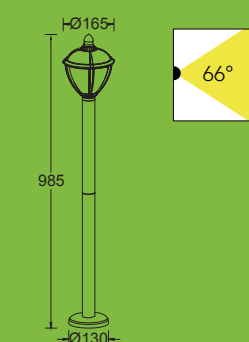

LADI

wall

Smart use of the integrated LED engine in the base of this contemporary lantern. The reflection on the white diffusor in the head creates a warm white glow towards the surface where the light is needed. The fully open aluminum frame creates an imaginative effect.



2631S-3K gr

CLASS I CE
IP44
LED 8W
420 Lumen
Die Cast Aluminium

A*

3000K

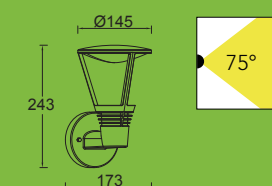

STARRY

wall

Cottage style rectangular wall light. With water glass. The invisible LED light source is perfectly placed to create a very charming warm white light in combination with the water drop glass.



1857-3K bl

CLASS I CE
IP54
LED 16W
600 Lumen
Die Cast Aluminium

A+

3000K

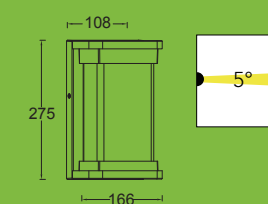

HOM

wall

Coach lantern with perfect "candle" light glow. The clear glass in combination with the LED light module offers a perfect radiation and high efficacy.



2411-3K bl

CLASS I CE
IP44
LED 16W
400 Lumen
Die Cast Aluminium

A+

3000K

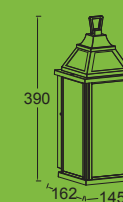

128°

CANDLE

wall

Straight lines integrated in a classic design. Vintage style combining traditional design elements and modern LED technology.



2502-3K gr

CLASS I CE
IP44
LED 11W
660 Lumen
Die Cast Aluminium

A+

3000K

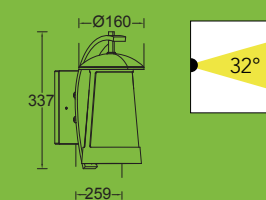

CATE

wall & bollard

This complete family with an authentic feel will turn your garden into a cozy & warm atmosphere, while using the newest "filament" LED bubs.



2642 br

CLASS I CE
IP44
E27 Max.60W
Die Cast Aluminium

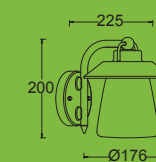

12642H4 br

CLASS I CE
IP44
E27 Max.60W
Die Cast Aluminium

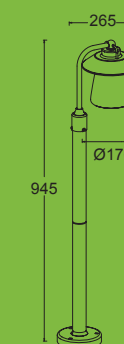

32642AF4 br

CLASS I CE
IP44
3*E27 Max.60W
Die Cast Aluminium

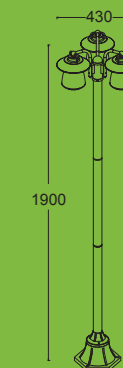

JADE

wall

This vintage coach lantern, in combination with the newest filament LED bulbs, gives a bright & sensational light effect



2592 bl

CLASS I CE
IP44
E27 Max.60W
Die Cast Aluminum

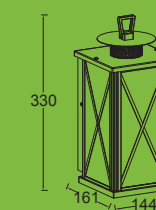

Solar



Solar

We developed different products for different applications around solar energy, portable lights or architectural, but always with the same ease of use and implementation. Today, as a result of continuous research, the high efficiency solar panels in combination with powerful LED modules are giving a really satisfactory level of light. Cleverly making the most out of the available solar energy is realised by intelligent user interfaces such as 3-step dimmer, timers and PIR-sensors, resulting in more autonomy and desired light levels.

portable
integrated panel
independent panel
hybrid



SOLAR ENERGY











































<p>PORTABLE</p>	 <p>P9080 TABLE CUBE / P136</p>	<p>NEW</p>  <p>P9080-450 TABLE CUBE / P138</p>	 <p>P9077 PADLIGHT / P140</p>	 <p>P9041 DRAGONFLY / P142</p>	 <p>P9003-ST MINI BUTTERFLY / P144</p>	 <p>P9035C BUMP / P146</p>	<p>WALL INTEGRATED PANEL</p>	 <p>P9040 LORD / P148</p>	 <p>61445-1-SL MINI LEDSPOT / P150</p>
 <p>61445-2-SL MINI LEDSPOT / P150</p>	 <p>P9034 ZERTA / P152</p>	 <p>P9015 BREAD / P154</p>	<p>NEW</p>  <p>ST9087 BUBBLE / P156</p>	<p>NEW</p>  <p>P9085 BRICK / P158</p>	 <p>ST9079 SOLSTEL / P160</p>	<p>NEW</p>  <p>ST9079-450 SOLSTEL / P160</p>	<p>NEW</p>  <p>P9067-PIR DISO / P162</p>	<p>NEW</p>  <p>P9067-450 DISO / P162</p>	 <p>P9014 GHOST SOLAR / P164</p>
 <p>P9011 ZETA / P166</p>	 <p>P9013 DROP / P168</p>	 <p>P9000 POLE / P170</p>	 <p>P9012 TILLY / P172</p>	<p>WALL INDEPENDENT PANEL</p>	 <p>P9016 SUNSHINE / P174</p>	 <p>P9019 OPENY / P176</p>	<p>NEW</p>  <p>P9044 MATRA / P178</p>	 <p>61015-PIR SL / P180 NEVADA</p>	 <p>61025-PIR SL / P180 NEVADA</p>
<p>HYBRID COLLECTION</p>	 <p>P9052 SPARTA / P185</p>	 <p>P9053 GREENBALL / P186</p>	 <p>P9054 GYQ25 / P186</p>	 <p>P9036 FLAM / P188</p>	 <p>ST9039 KIWA / P190</p>	 <p>ST9039-525 KIWA / P190</p>	 <p>ST9038 MINIS / P192</p>	 <p>ST9038-580 MINIS / P192</p>	 <p>P9037 STACK / P194</p>
 <p>P9037-450 STACK / P194</p>	 <p>9047 HONY / P196</p>	 <p>9049 HONY LOOP / P198</p>	 <p>9048 HONY DECK / P198</p>	<p>NEW</p>  <p>8012 PILLAR / P200</p>	<p>NEW</p>  <p>P2282S GLOBE / P202</p>				

TABLE CUBE

portable

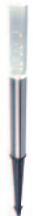

Handy & movable outdoor solar table light.



The 3 steps dimmer will always give you the right atmosphere in combination with a sufficient autonomy.

Comes in 3 vivid colours & a stylish silver grey.



Touchdimmer



1	100lm	4h
2	40lm	10h
3	10lm	40h
4	OFF	

Solar panel



1W polycrystal



P9080-3K si
P9080-3K wh
P9080-3K grn
P9080-3K or

CLASS III

IP44

LED 1W

1*1200mAh 3.7V Li-ion battery

100 Lumen

3000K



TABLE CUBE

portable

Bring Solar light in every corner of your garden.
 Bollard easy adjustable to full & medium height.
 Ground spike included.
 Comes with a 3 steps dimmer.

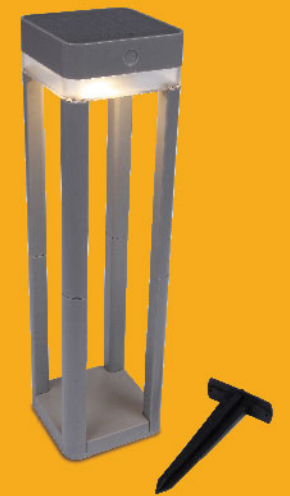

Touchdimmer



1	100lm	4h
2	40lm	10h
3	10lm	40h
4	OFF	

Solar panel



1W polycrystal

P9080-450-3K si

CLASS III
 IP44
 LED 1W
 1*2200mAh 3.7V Li-ion battery
 100 Lumen

3000K

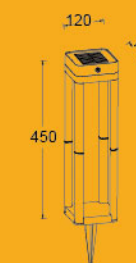

PADLIGHT

portable



Compact portable solar light. The ideal companion for your outdoor journeys. Versatile with multiple positions. Can be placed on a surface, hooked or suspended.



The light panel radiates a very uniform light without any shadow.



A 3-step dimmer gives you the possibility to optimise the light output & autonomy according to your needs.



The USB cable (included) allows also to charge via an electrical network.



Touchdimmer



1	200lm	3h
2	80lm	9h
3	20lm	36h
4	OFF	

Solar panel



1W Monocrystalline



P9077 wh
P9077 grn
P9077 or

CLASS III ⚡ CE
IP44
LED 4W
1*2500mAh 3.7V Li-ion battery
200 Lumen

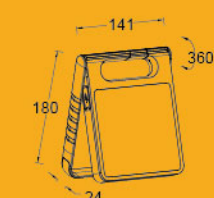

DRAGONFLY

portable



In the "open" position this portable solar lamp will accumulate sufficient solar energy during the daytime or alternatively be charged through a built-in USB connector and included cable.



In his closed position it will give an inviting light when it is dark.



Comes with 3 step dimmer. Available in 4 fresh colours.



Touchdimmer







1	120lm	4h
2	50lm	10h
3	10lm	40h
4	OFF	

Solar panel



2*0.8W polycrystal

-  **P9041 wh**
-  **P9041 si**
-  **P9041 grn**
-  **P9041 or**

CLASS III  
 IP54
 LED 1.2W
 1*2200mAh 3.7V Li-ion battery
 Synthetics
 120 Lumen

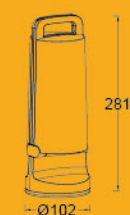

MINI BUTTERFLY

portable



Clever & convenient design.



When opening the "wings" of this butterfly, the 2 solar panels can efficiently capture the sunlight and charge the batteries in 4 hours-time.



The USB cable (included) allows also to charge via an electrical network.Recharging of your mobile phone is possible via the USB port.



As stand-alone light, the torch can suspended from its hook or held using the magnet in its base.



Comes with a 3-step dimmer and available in 3 fresh colours.



Touchdimmer



1	180lm	4h
2	70lm	10h
3	18lm	40h
4	OFF	

Solar panel



2*1.2W polycrystal



P9003-ST wh
P9003-ST grn
P9003-ST or

CLASS III ⚡ CE
 IP44
 LED 1.6W
 1*2200mAh 3.7V Li-ion battery
 180 Lumen

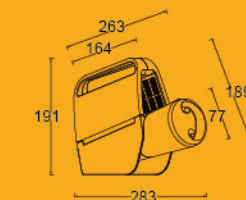

BUMP

portable



Portable solar outdoor light with versatile application possibilities. Can be used as a table light, portable with the integrated handle. Unclip the handle and cord and it can be suspended.



Two charging possibilities: through separate monocrystalline solar panel providing solar energy or through the USB cable. Can also be used for recharging your mobile phone.



Touchdimmer



1	100lm	5h
2	40lm	7h
3	10lm	15h
4	OFF	

Solar panel



1.4W Monocrystalline



P9035C wh
P9035C grn
P9035C or

CLASS III

IP44

LED 1W

1*2200mAh 3.7V Li-ion battery

100 Lumen

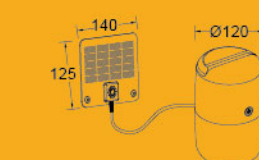

LORD

integrated panel



Compact and easy to install solar wall light with integrated monocrystalline solar panel inside a circular shield.



Mount the bracket on the wall with 2 screws and then just slide the body on. No wiring, mounted in no time!



Solar panel



1.4W Monocrystalline



TIME 5h

P9040 si

CLASS III

IP44

LED 1W

1*2200mAh 3.7V Li-ion battery

100 Lumen



4000K

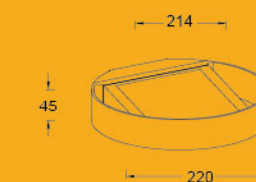



MINI LEDSPOT

integrated panel



Wall light with integrated solar panel, single and doublehead spot light versions. Both the panel and the spot heads are adjustable over a wide angle.



This will assure you an optimal solar efficiency. The bright LED spotlight can be orientated in all directions.



The 3 steps dimmer offers you the choice between bright and long-lasting light.



Dimmer



	OFF
H	100lm 6h
M	50lm 10h
L	30lm 21h

Solar panel



1.4W Monocrystalline

Dimmer



	OFF
H	200lm 6h
M	100lm 10h
L	60lm 21h

Solar panel



3.6W Monocrystalline

6144S-1-SL si

CLASS III CE
 IP44
 LED 1W
 1*2200mAh 3.7V Li-ion battery
 100 Lumen

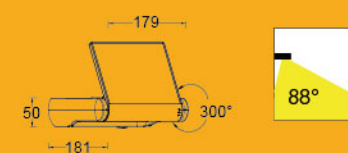

6144S-2-SL si

CLASS III CE
 IP44
 LED 2W
 1*2200mAh 7.4V Li-ion battery
 200 Lumen

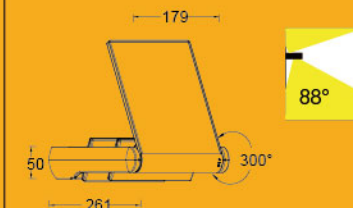

ZERTA

integrated panel



Very sleek & elegant design, almost invisible. The high capacity, perfectly integrated mono-crystalline solar panel can charge solar energy very efficiently. This energy can be used to radiate a powerful and long-lasting light during your hot summer nights.



Solar panel



3.6W Monocrystalline

TIME 5h

P9034 si

CLASS III

IP44

LED 3W

1*2200mAh 7.4V Li-ion battery

200 Lumen

4000K

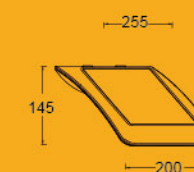

BREAD

integrated panel



Compact and easy to install solar wall light.
Fits perfectly to many different outdoor styles.



The built-in motion sensor assures you a
welcoming light throughout the night.

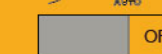

Solar panel



1W polycrystal

P9015 si

CLASS III CE

IP44

LED 1.2W

1*2200mAh 3.7V Li-ion battery

100 Lumen

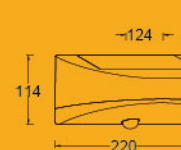

SENSOR

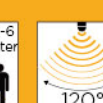

BUBBLE

integrated panel



Half-globe solar light radiating a homogenous light.



The PIR motion sensor, nicely incorporated in the stainless steel ring, will capture all movement and assures a powerful light any time somebody is passing throughout the night.



Dimmer

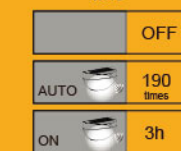

Solar panel



1.5W polycrystal

ST9087

CLASS III
 IP44
 LED 2.3W
 1*2200mAh 3.7V Li-ion battery
 200 Lumen



SENSOR



BRICK

integrated panel

Minimalistic design, easy installation on all different surfaces.



Elegant built-in motion sensor with wide angle and large reach will capture every movement. Time & Light sensitivity regulation possible with levers at the inside.

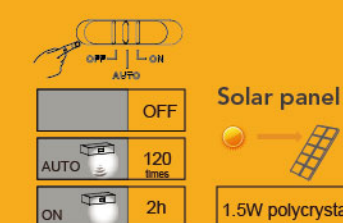

P9085

CLASS III
 IP44
 LED 1.5W
 1*2200mAh 3.7V Li-ion battery
 150 Lumen
 Stainless steel

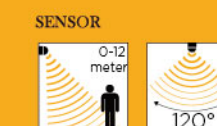
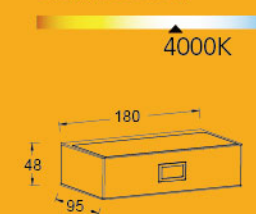

SOLSTEL

integrated panel



Solar wall light with an opal diffuser. Gives a powerful and diffused light throughout the night thanks to the motion sensor option.



The brushed stainless steel cover has also a bracket function. The light part can be slid into place without any tools. The house number sticker set makes the package complete.

The bollard version has the same functionalities and is easy to mount with screws or with a ground spike (included)



+ 1 · A



OFF	Solar panel
AUTO 150 times	1W monocrystalline
ON 2.5h	



OFF	Solar panel
AUTO 140 times	1W monocrystalline
ON 2.5h	

ST9079

CLASS III CE
 IP44
 LED 1.3W
 1*2200mAh 3.7V Li-ion battery
 100 Lumen
 Stainless steel

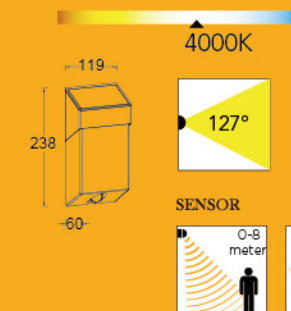

ST9079-450

CLASS III CE
 IP44
 LED 2.3W
 1*2200mAh 3.7V Li-ion battery
 150 Lumen
 Stainless steel

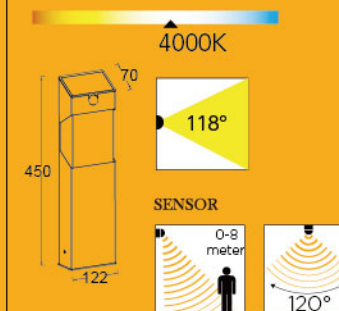

DISO

integrated panel



Solar panel is perfectly integrated in the ingenious design. Ready to capture the full sunlight. Moveable head will orientate the light beam to the desired spot.



The wall version comes with a PIR motion sensor which assures you a power full light any time somebody is passing.



Bollard version mountable with screws or with included ground spike.

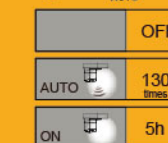

Solar panel



1.5W polycrystal

P9067-PIR gr

CLASS III
 IP44
 LED 2W
 1*2200mAh 3.7V Li-ion battery
 200 Lumen

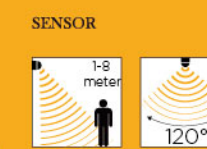
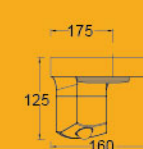

P9067-450 gr

CLASS III
 IP44
 LED 2W
 1*2200mAh 3.7V Li-ion battery
 200 Lumen

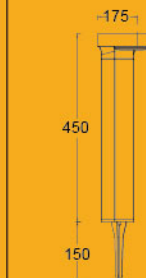

GHOST SOLAR

integrated panel



Sleek and elegant design.



This wall washer with integrated solar panel and wide angle PIR motion sensor offers you a strong light when needed.

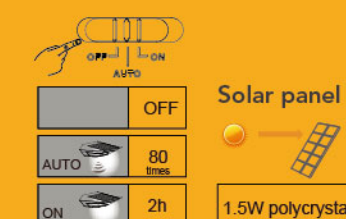

P9014 si

CLASS III
 IP44
 LED 2.4W
 1*2200mAh 3.7V Li-ion battery
 260 Lumen

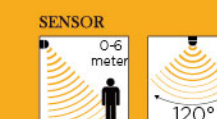

ZETA

integrated panel



This wall light offers you the complete freedom to orientate the solar panel and the light panel in the optimum direction.



In combination with the PIR motion sensors it will give a strong light to any outdoor space.



OFF	OFF
AUTO	120 times
ON	2h

Solar panel



1.5W polycrystal

P9011 si

CLASS III
 IP44
 LED 2.4W
 3*1800mAh 1.2V Ni-MH AA battery
 200 Lumen

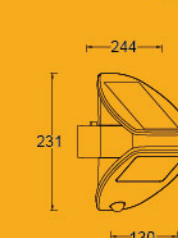

SENSOR

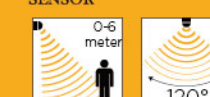

DROP

integrated panel



The solar panel with the integrated spotlight recessed into its surface gives a distinctive image.



The spotlight with centrally built-in motion sensor offers you the possibility to orientate the light exactly where it is needed to give you a warm and safe welcome throughout the night.

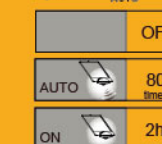

Solar panel



2.5W polycrystal

P9013 si

CLASS III

IP44

LED 2.3W

1*2200mAh 3.7V Li-ion battery

240 Lumen



4000K

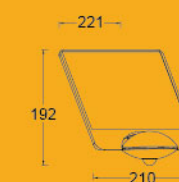

73°

SENSOR



0-6 meter



120°

POLE

The solar wall lights BREAD, ZETA & DROP can be mounted easily and without any tools on an independent post, creating a perfect bollard solution. The post can be screwed on a solid surface or put into the ground thanks to the included spike. The post contains 3 tubes giving the option to vary the height up to 1 meter.



P9000 si

Color silver (si)
for
P9011
P9013
P9015

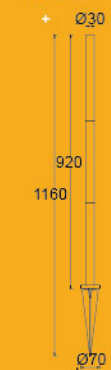

TILLY

integrated panel



A slim, futuristic design. The sleek adjustable spot heads can be orientated under the solar panel surface, giving multiple directions and powerful light beams.



In combination with the subtle and centrally positioned PIR sensor, it will detect any movement throughout the night and will illuminate any foreseen or unforeseen guest.

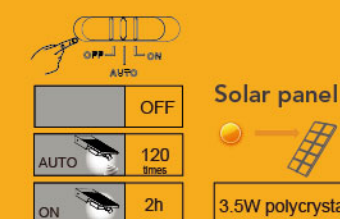
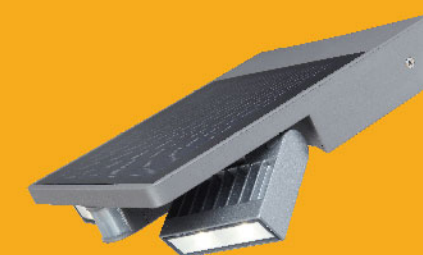

P9012 si

CLASS III
 IP44
 LED 4W
 1*2200mAh 3.7V Li-ion battery
 420 Lumen

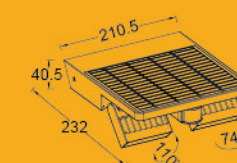

SENSOR



SUNSHINE

independent panel



This wall light offers a complete security light installation without any wiring to the electricity network. The separate adjustable solar panel with its 5 m cable can be positioned on the optimum spot to capture sunlight all day long.



Comes with an adjustable (time & distance) PIR motion sensor. The movable spot head will give more than 350 lumen.

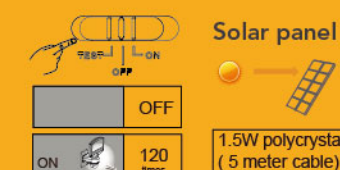

P9016 si

CLASS III
 IP44
 LED 3.2W
 1*2200mAh 3.7V Li-ion battery
 360 Lumen

4000K

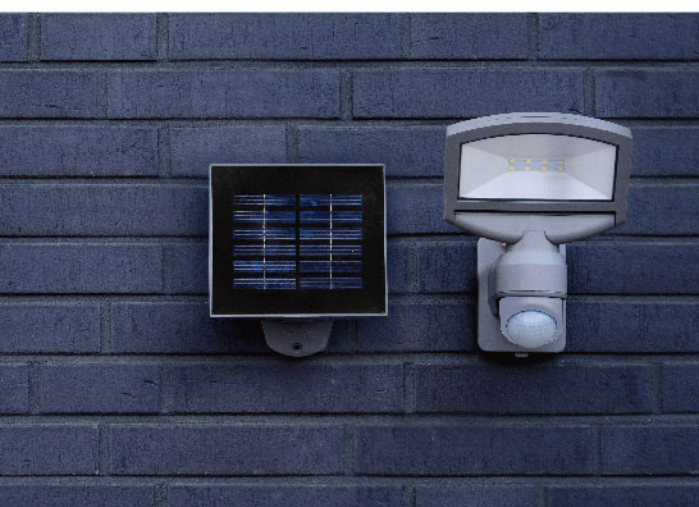
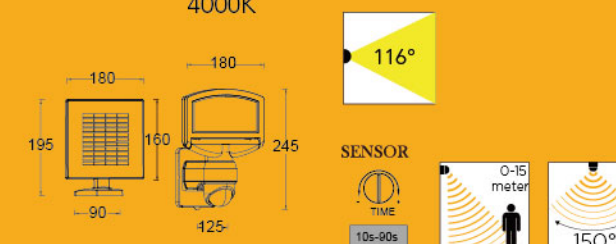

Wiring system

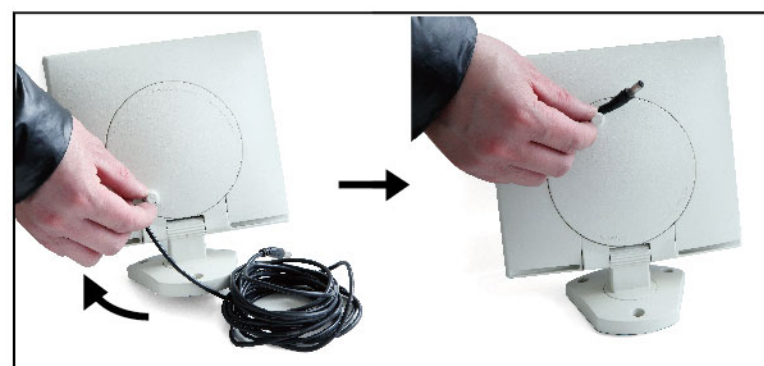

OPENY

independent panel



Full option solar security light.



The two elegant and adjustable heads give the possibility to cover a large area.



Functions as a powerful detection light all night long and makes your outdoor space a safer place.

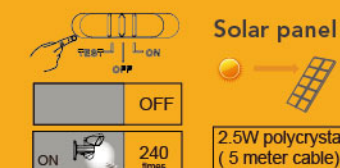

P9019 wh

CLASS III
 IP44
 LED 4W
 1*2200mAh 7.4V Li-ion battery
 500 Lumen

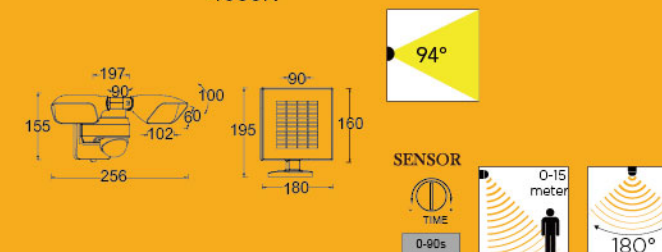

Wiring system

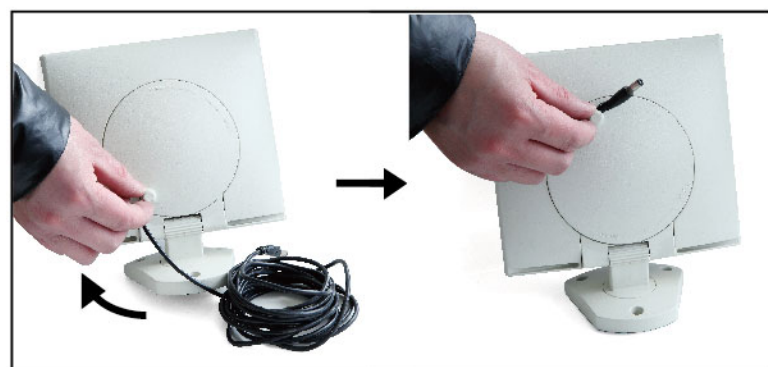

MATRA

independent panel



Most powerful solar security light in our range. With a lightoutput of more than 1000 lumen, you can create really a sea of light during the complete night. The solar panel featuring an easy wiring sytem to stock the wire which is not needed.



Functions as a powerful detection light all night long and makes your outdoor space a safer place.

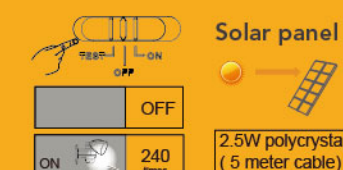

P9044 wh

CLASS III
IP44
LED 11W
1*2200mAh 7.4V Li-ion battery
1030 Lumen

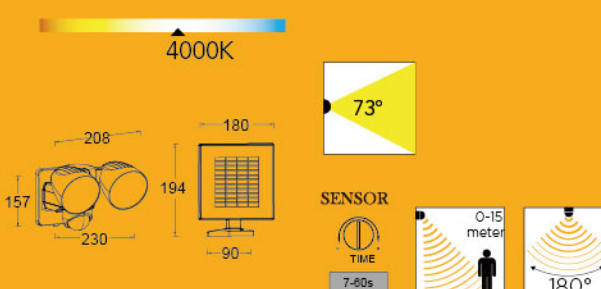

Wiring system

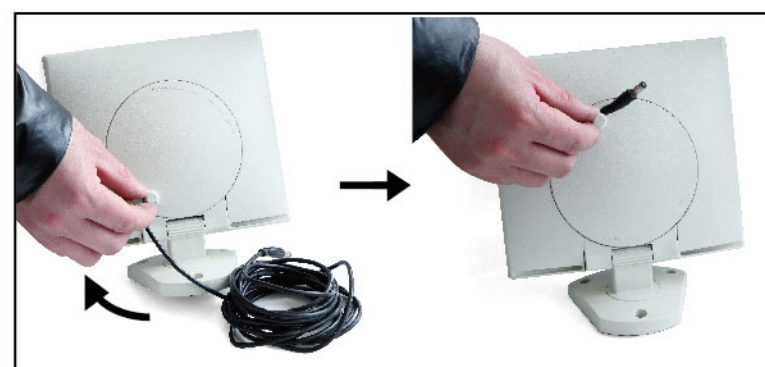

NEVADA

independent panel



Die-cast aluminium square and round spot light.



Robust construction and fully adjustable.



The powerful LED light source in combination with the adjustable PIR sensor gives a great "security light" solution.



OFF	AUTO	ON
120 times	2h	

Solar panel



3.5W polycrystal (5 meter cable)



OFF	AUTO	ON
120 times	2h	

Solar panel



3.5W polycrystal (5 meter cable)

61015-PIR SL gr

CLASS III
 IP44
 LED 4W
 1*2200mAh 7.4V Li-ion battery
 450 Lumen

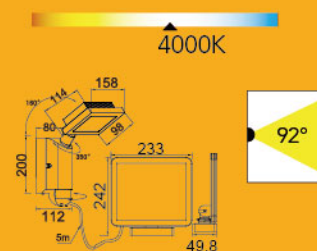

6102S-PIR SL gr

CLASS III
 IP44
 LED 4W
 1*2200mAh 7.4V Li-ion battery
 450 Lumen

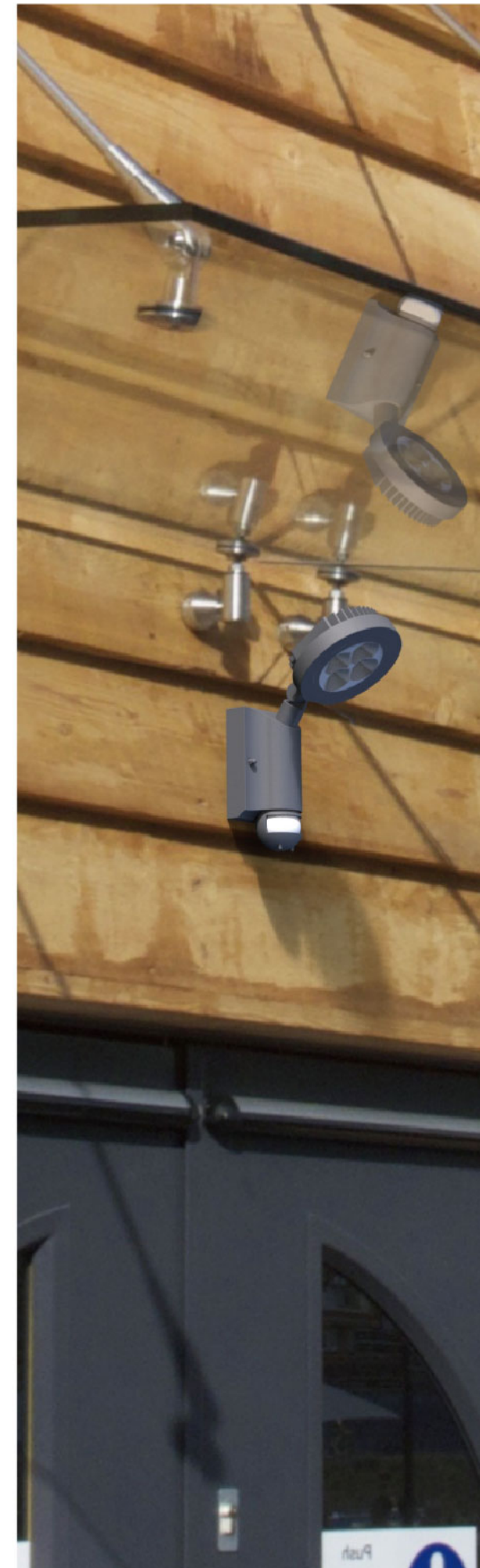
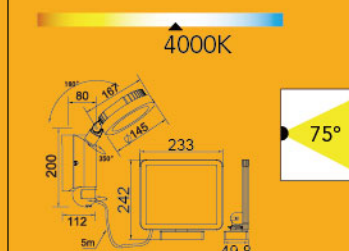

SUN'CONNEC

SOLAR/HYBRID COLLECTION



SPARTA solar panel
with integrated battery



GREEN BALL connecting
the solar panel, the lamps
and optionally the transfo.
Dusk/dawn sensor



The optional motion sensor
communicate with the
GREEN BALL



Plug in transfo



Fixation, pick or screw
or wall fixation

THE LAMPS



FLAM



HONY



KIWA



MINIS



STACK



DECK, LOOP & HONY

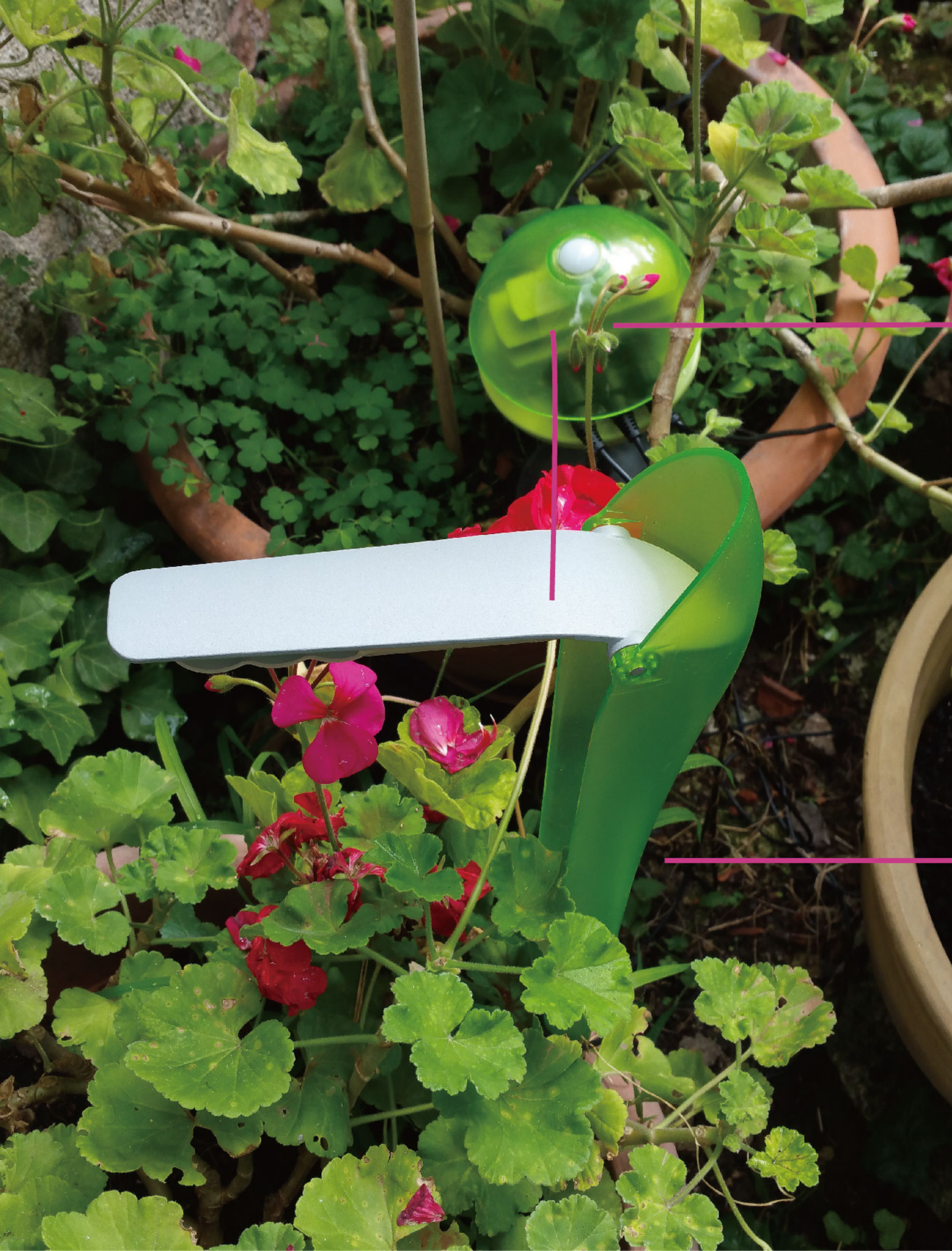
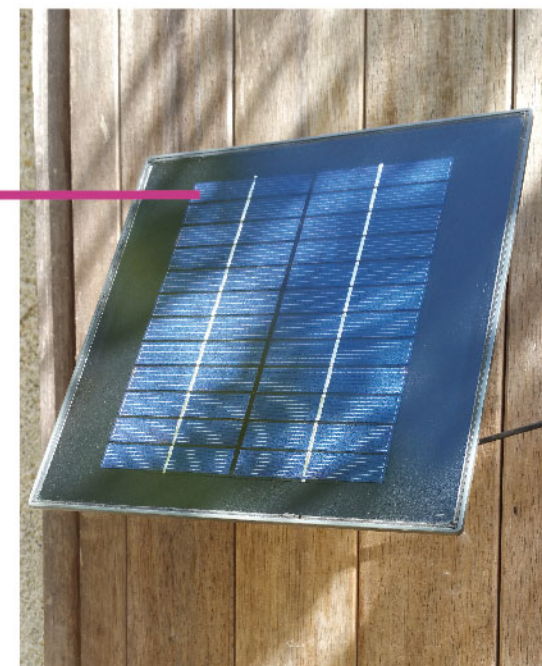

A Solar Energy Lighting System for Gardens and Terraces

HYBRID SYSTEM CHOOSE YOUR POWER



GREENBALL HUB Control and connect all elements together

LED LIGHTING FIXTURES Efficient and long lasting

PICK or SCREW Easy installation



Flexible Installation

Thanks to the connection accessories you have the full freedom to make any desired installation.

- Plug-in transfo 6W or 12W
- 3 way connector
- 2 way connector
- 5 metre cable

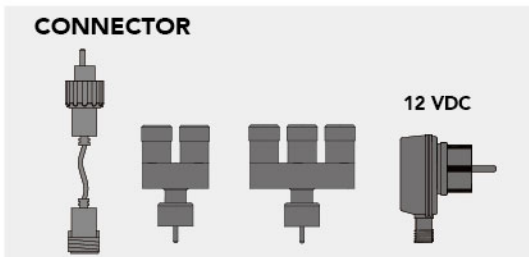

Large Autonomy

Fully charged Li-ion battery 2200mAh-7.4v		
1 x 100 lumen	12 hours	
2 x 100 lumen	6 hours	
3 x 100 lumen	4 hours	

HYBRID SYSTEM CHOOSE YOUR COMBINATION

4 Combinations

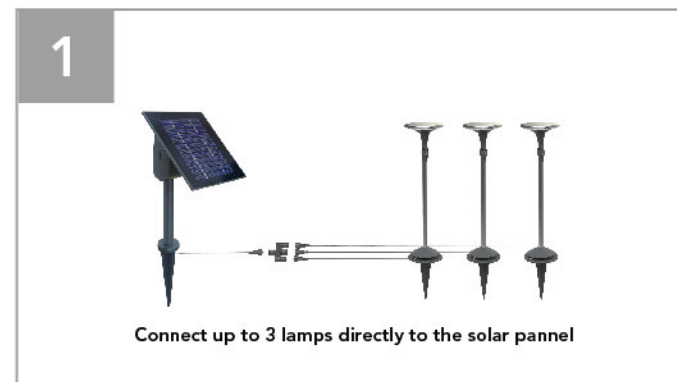

SOLAR ENERGY

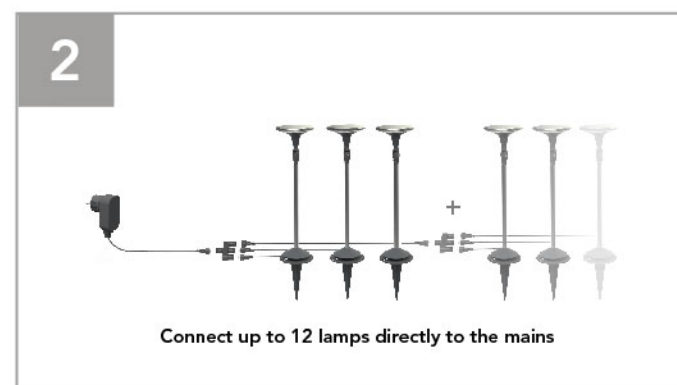

ELECTRIC ENERGY

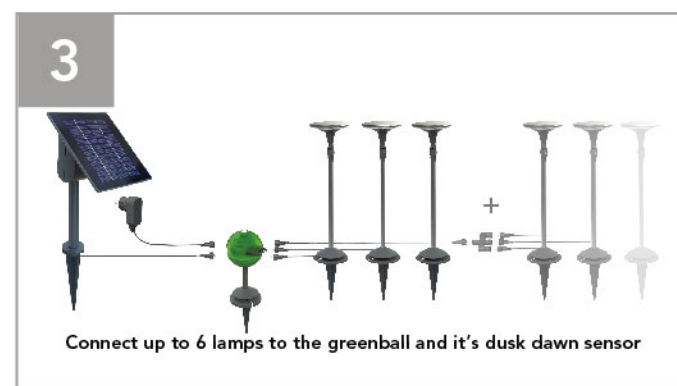

HYBRID SYSTEM

The system switches automatically to the mains when the batteries run out of solar energy

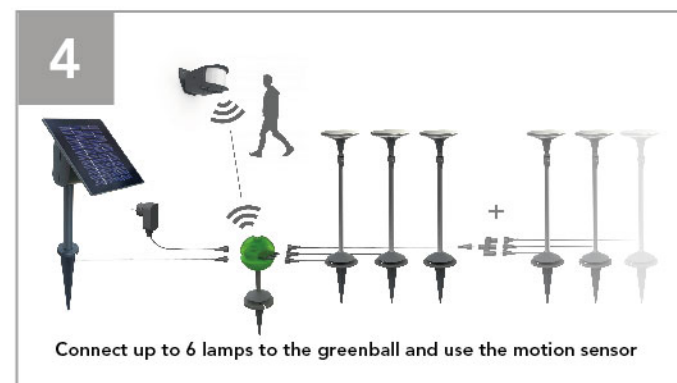

Wireless PIR motion sensor
Moveable & adjustable
Time: 1-3-5 minutes
Distance: 5-8-12 metres

SPARTA

SUN'CONNEX

High capacity poly-crystalline solar panel.
Elegant and sleek design : no visible screws
or connections. Including a Li-ion rechargeable
battery. The adjustable panel can be installed
on a wall or on a pole. The included spike
gives you another installation option.



P9052

CLASS III
IP44
12V 4W
1*2200mAh 7.4V Li-ion battery

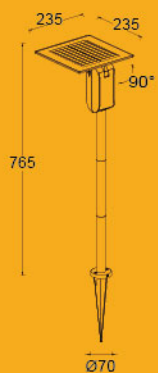

GREEN BALL

SUN'CONNEX

The Green ball "HUB" is the dispatch centre
of the system. It controls and connects all
elements together. The luminaires, the solar
panel, the connection to the mains adaptor
and the connection with the wireless motion
sensor. The built in dusk/dawn sensor controls
the lamps and the power source.

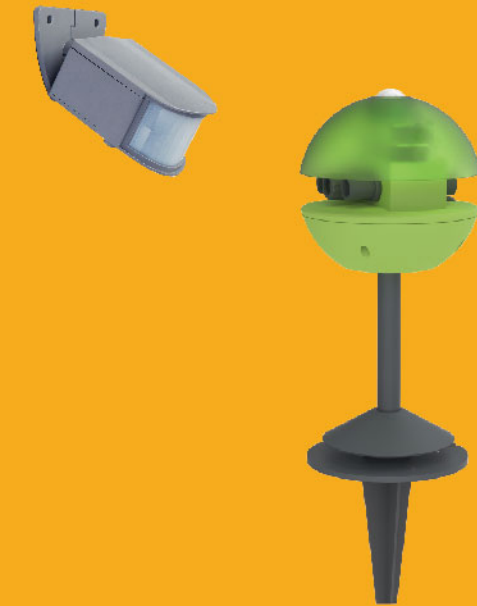

P9053

CLASS III
IP44
2*12V DC input
3*12V DC output

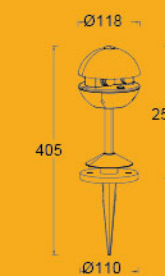

P9054

CLASS III
IP44
4x1.5V AAA Battery

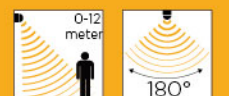

FLAM

SUN'CONNEX

A playful and colourful design giving diffused or direct light. A vibrant light animating your garden.

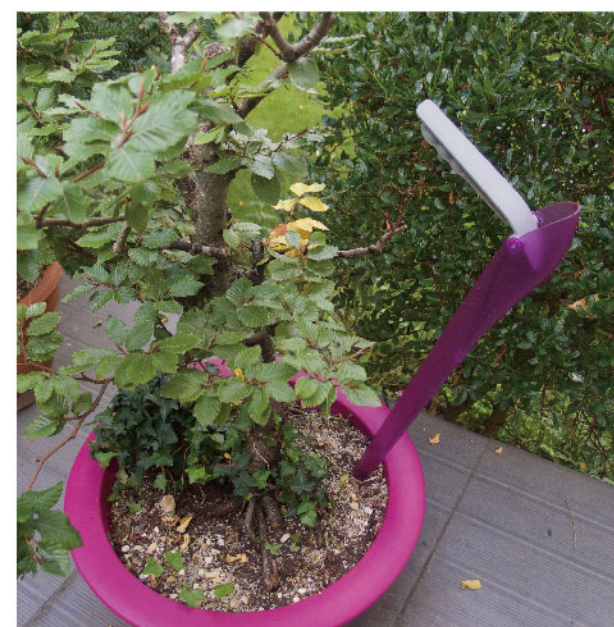

P9036 prp
P9036 grn

CLASS III ⚡ CE
IP44
LED 1W
Input: 12V DC
100 Lumen

4000K

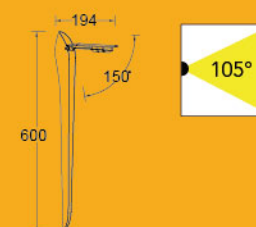

2-P9036

Set
green (grn)
purple (prp)
2 x P9036 (LIGHT)
1 x P9052 (PANEL)



KIWA

SUN'CONNEX

A playful and colourful design giving diffused or direct light. A vibrant light animating your garden.



ST9039

CLASS III  
 IP44
 LED 1W
 Input: 12V DC
 Stainless Steel
 100 Lumen

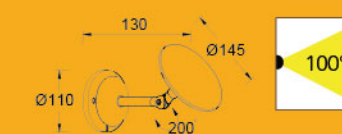

2-ST9039

Set
 2 x ST9039 (LIGHT)
 1 x P9052 (PANEL)

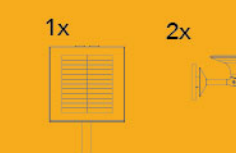

ST9039-525

CLASS III  
 IP44
 LED 1W
 Input: 12V DC
 Stainless Steel
 100 Lumen

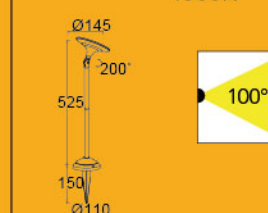

2-ST9039

Set
 2 x ST9039-525 (LIGHT)
 1 x P9052 (PANEL)

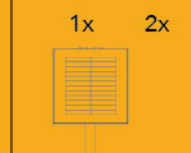

MINIS

SUN'CONNEX

A freely moving, slim and discrete light which fits perfectly in the environment with its reflecting back. Wall and post spike version.



ST9038

CLASS III ⚡ CE
IP44
LED 1W
Input: 12V DC
Stainless Steel
100 Lumen

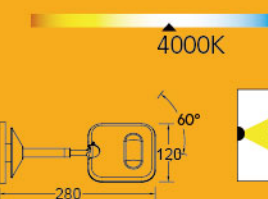

2-ST9038

Set
2 x ST9038 (LIGHT)
1 x P9052 (PANEL)

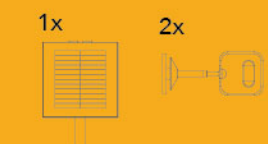

ST9038-580

CLASS III ⚡ CE
IP44
LED 1W
Input: 12V DC
Stainless Steel
100 Lumen

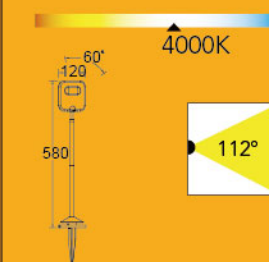

2-ST9038

Set
2 x ST9038-580 (LIGHT)
1 x P9052 (PANEL)

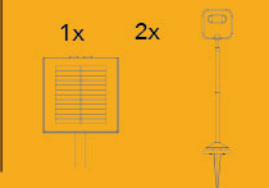

STACK

SUN'CONNEX

An efficient adjustable spotlight. Multiple heads can be clicked onto the same post offering a sea of light.



P9037

CLASS III
IP44
LED 1W
Input: 12V DC
120 Lumen

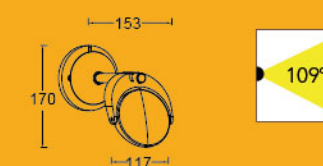

2-P9037

Set
2 x ST9037 (LIGHT)
1 x P9052 (PANEL)

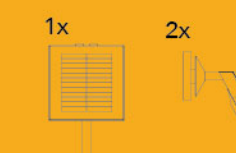

P9037-450

CLASS III
IP44
LED 1W
Input: 12V DC
120 Lumen

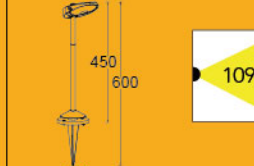

2-P9037-450

Set
2 x ST9037-450 (LIGHT)
1 x P9052 (PANEL)

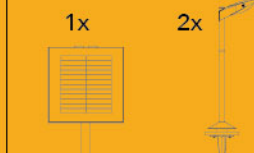

HONY

SUN'CONNEX

Crystal Light. Plays with transparency and functionality. Very elegant and directional spot head with a powerful beam.



9047

CLASS III ⚡ CE
 IP67
 LED 1W
 Input: 12V DC
 100 Lumen

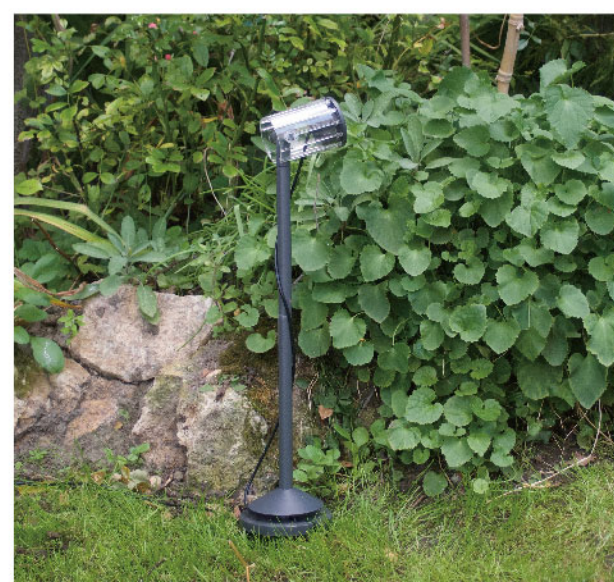
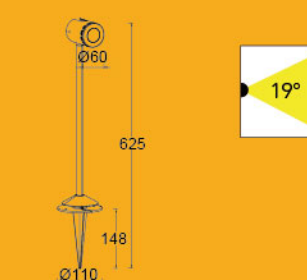



LOOP DECK & HONY DECK

SUN'CONNEX

Deck light versions, use HONEY to punctuate your terrace. HONEY LOOP version giving a nice glow in 4 directions. HONEY DECK can be used as orientation light.



9049
 CLASS III ⚡ CE
 IP67
 LED 1W
 Input: 12V DC
 100 Lumen
 4000K

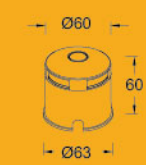

9048
 CLASS III ⚡ CE
 IP67
 LED 1W
 Input: 12V DC
 100 Lumen
 4000K

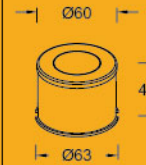

- 2-9048**
- Set
 2 x 9048 (LIGHT)
 1 x P9052 (PANEL)
- 1x 2x
-

PILLAR

SUN'CONNEX

Crystal pearl effect, will bring your garden in a magical atmosphere.



8012-SL

CLASS III  
 IP54
 LED 1.1W
 Input: 12V DC
 80 Lumen

 4000K

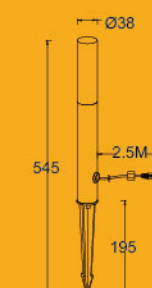



GLOBE

SUN'CONNEX

Globe with perfect 360° light radiation.
Perfect fit in all gardens.



P22825-SL

CLASS III  
IP54
LED 1W
Input: 12V DC
82 Lumen

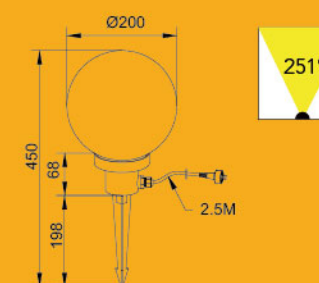

Security & Work Light

S & W

Security & Work Light

SECURITY consists of a compact range focussing on safety applications. Powerful floodlights with adjustable single or multiple spot heads, enable large areas to be lit. The PIR-movement sensor equipped with multiple parameter settings enables the installation of a perfect detection system.

WORK LIGHT full range covering all lighting needs for any work shop or construction site. From small to large, from domestic to professional. We focus on easy manipulation and light efficiency and being compact when not in use.

wall
ceiling
spike
portable
tripod

S & W

SECURITY & WORK LIGHT

WALL

		 NEW						
6156-PIR CORN / P204	6294-PIR PERI / P206	6322-PIR ARC / P208	6219A SHRIMP I / P210	6219A-PIR SHRIMP I / P210	6231-PIR SHRIMP II / P212	P6221A-PIR SHRIMP II / P212	61015-PIR NEVADA / P216	61025-PIR NEVADA / P216

FLOOD

								
8091 HAMBURG / P214	6170 NEGARA / P218	6170-PIR NEGARA / P218	6170-SP NEGARA / P218	6170S NEGARA / P220	6170S-PIR NEGARA / P220	6170S-SP NEGARA / P220	6226 ADO / P222	6243 ZIPO / P224

WORKLIGHT

								
6297 UTIN / P226	6229 FRONT / P228	6229-800 FRONT / P228	6230 FRONT / P228	6225 COLLA / P230	6224 OWL / P232	6223 OWL / P232	6290 PERI / P234	6293 PERI / P236

CAMERA

CAMERA

				
6255-CAM ESA / P238	6295-CAM PERI / P240	6324-CAM LIBRA / P242	ST1906-CAM VESTA / P244	ST2671-CAM ELARA / P246

CORN

wall

Ingenious security light. The articulation possibilities over the central rotating part and the individual adjustable spot heads gives an incredible range of settings. The powerful LED source makes your outdoor areas as bright as day. The combination of the stylish cooling ribs on the back and the LED source results in a very low heat emission. This allows the floodlight to be installed under porches.



The PIR sensor is adjustable in time and distance covering a wide detection area.



6156-PIR gr

CLASS I CE
IP54
LED 20W
Die Cast Aluminum
2100 Lumen

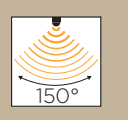
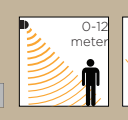
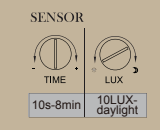
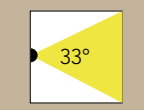
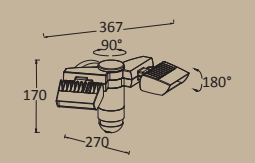

PERI

wall

 This new version of security floodlight combines a very powerful LED source with a double and adjustable motion sensor. The frontal sensor has a detection range of up to 20 metres. The second sensor covering the area under the floodlight detects movement close to the wall.

 The electrical jack connection allows a simple and easy installation, with no tools needed. The PERI series comes in a single and double spot head version and is suitable for wall and ceiling mounting thanks to the rotating base.

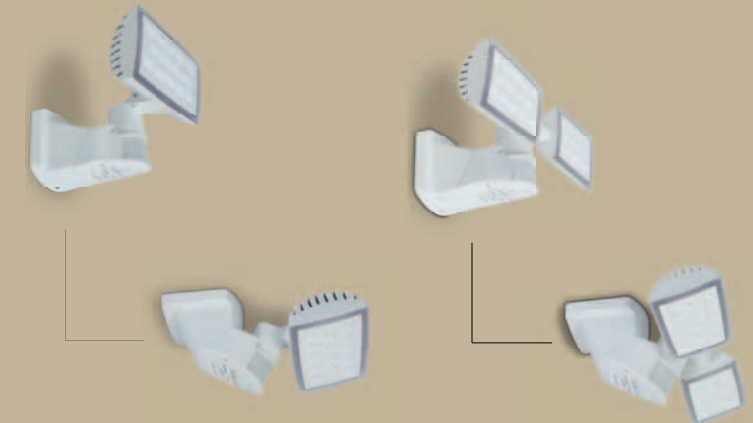

Quick install

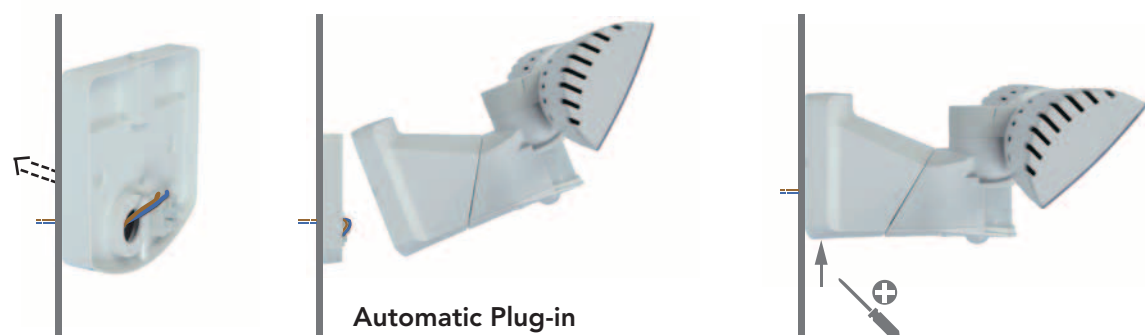

6295-PIR-5K wh

CLASS I 
 IP54
 LED 16W
 ABS and PC
 1710 Lumen

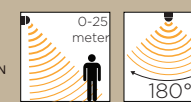
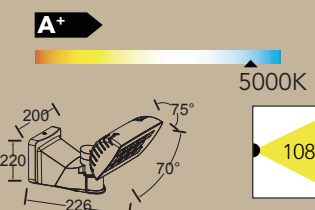

6294-PIR-5K wh

CLASS I 
 IP54
 LED 32W
 ABS and PC
 3280 Lumen

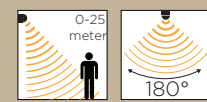
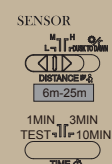
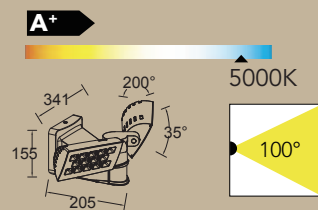

ARC

wall



Elegant double head projector with fully adjustable motion sensor.



The two "wings", feature a diffusor surface without edges, resulting in a perfectly homogeneous light beam. The multiple orientation possibility gives you full flexibility to cover the desired area.



6322-PIR-5k wh

CLASS I CE
IP54
LED 19W
Die Cast Aluminum
1200 Lumen

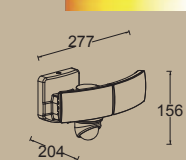
A+

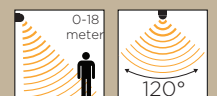
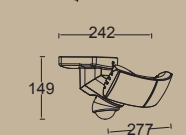
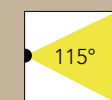

5000K



SHRIMP I

wall



Elegant yet powerful security floodlight with typical "bike lamp" design.



This series is available with or without adjustable PIR motion sensor.



6219A-PIR bl

CLASS I CE
IP54
LED22W
Die Cast Aluminum
1380 Lumen

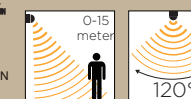
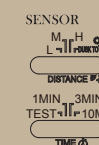

6219A bl

CLASS I CE
IP54
LED 22W
Die Cast Aluminum
1380 Lumen

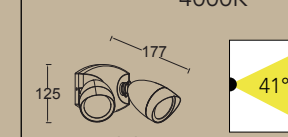

SHRIMP II

wall



Robust execution in die-cast aluminium, American style with "Mickey" ears spot head design. Amazing light output of almost 3000 lumen will turn large outdoor spaces in a sea of light.



The adjustable PIR motion sensor detects movement up to 20 metres.



6231-PIR-5k bl

CLASS I CE
IP54
LED35W
Die Cast Aluminum
2860 Lumen

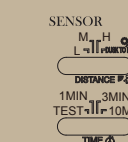
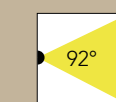

P6221A-PIR23-5k bl

CLASS II CE
IP54
LED 15W
Synthetics
1360 Lumen

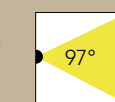

HAMBURG

spike



This LED garden spot will put all your trees, bushes and ornaments in the spotlight and create a dramatic scenery.



8091 gr

CLASS I CE
IP54
LED8W
Die Cast Aluminum
580 Lumen
A+
4000K

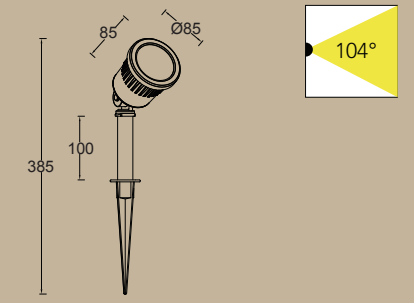

NEVADA

wall



Impact proof die-cast aluminium security light. The multiple rotation possibilities of the spot head and the motion sensor allows an easy and flexible installation.



6101S-PIR gr

CLASS I CE
IP54
LED24W
Die Cast Aluminum
1550 Lumen

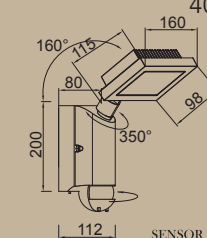

6102S-PIR gr

CLASS I CE
IP54
LED 22W
Die Cast Aluminum
1520 Lumen

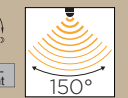
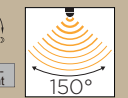
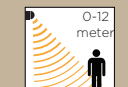
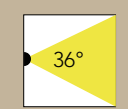
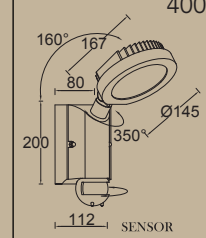

NEGARA

wall & spike



Very classy LED floodlight in silver grey finish. The layout of the 8 powerful LEDs in the perforated aluminium reflector gives an extra design touch.



The PIR motion sensor and spike version make the series complete.



6170-PIR si

CLASS II CE
IP54
LED24W
Die Cast Aluminum
1540 Lumen

A+

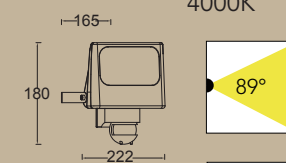

SENSOR

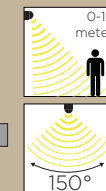

6170 si

CLASS II CE
IP54
LED 24W
Die Cast Aluminum
1540 Lumen

A+

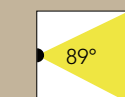
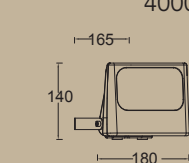

6170-SP si

CLASS II CE
IP54
LED 24W
Die Cast Aluminum
1540 Lumen

A+

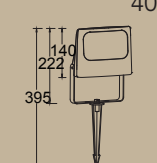

NEGARA

wall & spike



Small brother of the big NEGARA. Minimalistic and functional design. This LED floodlight generates a very low level of heat, allowing the installation under porches or overhanging roofs.



6170S-PIR si

CLASS I CE
IP54
LED10W
Die Cast Aluminum
860 Lumen



SENSOR



10s-8min 10LUX daylight



6170S-SP si

CLASS II CE
IP54
LED 10W
Die Cast Aluminum
860 Lumen

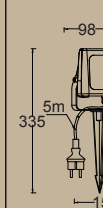

6170S si

CLASS I CE
IP54
LED 10W
Die Cast Aluminum
860 Lumen

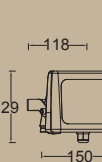

ADO

wall & portable



Compact and sleek design LED floodlight. Easy orientation and locking of the spot head thanks to 2 manual rotating buttons.



6226 gr

CLASS I CE
IP54
1 COB LED 11W
Die Cast Aluminum
900 Lumen

A+

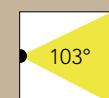
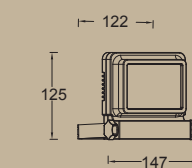
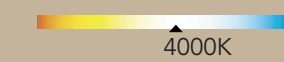

ZIPO

wall



Professional LED flood light, comes in narrow and wide beam versions. Thanks to rotation angle of twice 90°, possibility to use as wall washer, spotlight or down lighter.

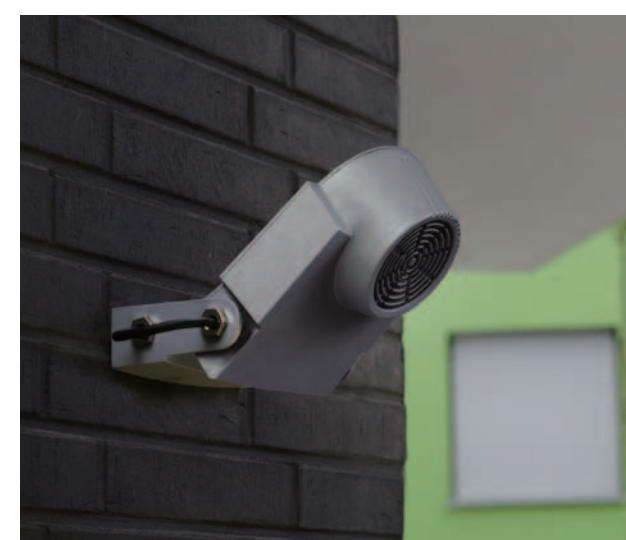

6243 N gr

CLASS I CE
IP65
1 COB LED 34W
Die Cast Aluminum
2030 Lumen
A+

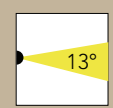
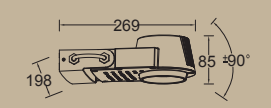
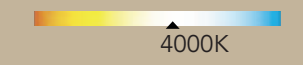

6243 W gr

CLASS I CE
IP65
1 COB LED 34W
Die Cast Aluminum
1904 Lumen
A+

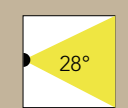

UTIN

portable



Compact portable LED work light, great look and striking colour combination. Easy to store and transport. You perfect companion for all your DIY projects. Comes with a 1.8m cable and plug.



6297-5K ye

CLASS II CE
IP54
LED 10W
Die Cast Aluminum
850 Lumen
A+

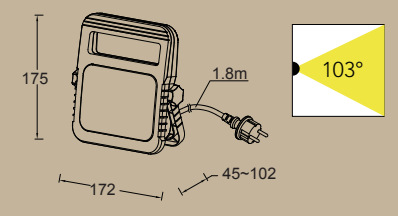

FRONT

portable

Compact yet powerful LED work light series, featuring wall, portable and extended bar versions. A wide variety of applications in combination with a fast and easy installation and storage. The portable version of the FRONT comes with a 1.5m cable & plug.



6229 gr

CLASS I CE
IP54
1 COB LED 11W
Die Cast Aluminum
900 Lumen

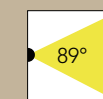
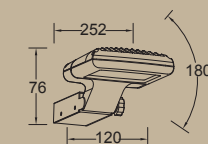

6230 gr

CLASS I CE
IP65
1 COB LED 11W
Die Cast Aluminum
900 Lumen

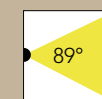
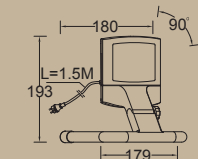
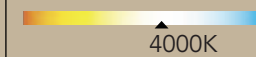

6229-800 gr

CLASS I CE
IP54
1 COB LED 11W
Die Cast Aluminum
900 Lumen

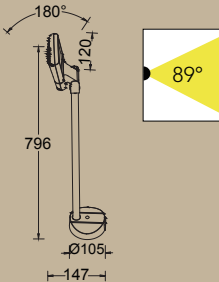
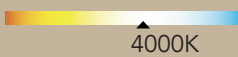

COLLA

portable

 Cleverly designed LED work light. The multiple adjustment possibilities of the support enhances a wide variety of working positions. Easy to manipulate and compact for storage or transport. Comes with a 1.8m cable and plug. The centrally placed LED produces a powerful beam of more than 1500 lumen.



6225 gr

CLASS I CE
IP54
LED 18W
Die Cast Aluminum
1800 Lumen

A+

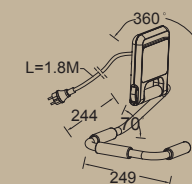
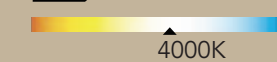

OWL

portable



When a lot of light is needed for your DIY projects, the OWL offers you a versatile and efficient solution. The double head adjustable work light can be mounted on a separate tripod. Very convenient to light large empty rooms. Comes with a 2.0m cable & plug.



6224 gr

CLASS I CE
IP54
2 COB LED 30W
Die Cast Aluminum
2280 Lumen

A+

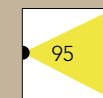
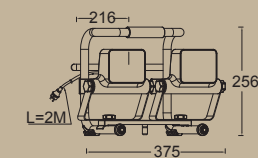

6223-pole gr

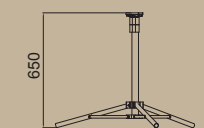
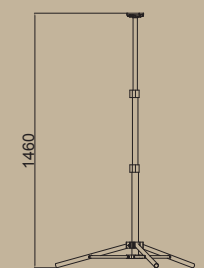

PERI

portable

The Tripod floodlight re-invented. The PERI double head LED work light is really a super performer. When closed, it is easy to transport thanks to the practical handle, a 2.5 m cable wrap and its compact dimensions. The installation is both logical and fast. Thanks to the telescopic and manual lock system, you can build up in no time a stable and height-adjusted tripod. The double LED spot adjustable works in 2 rotation axes.



6290-5K gr

CLASS II CE
 IP54
 LED 35W
 Die Cast Aluminum
 3200 Lumen

A+

5000K

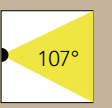
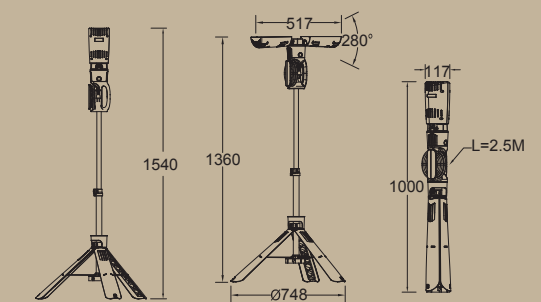

PERI

portable



Portable version of the PERI range. Featuring the same 2 powerful LED spotlights. Both easy adjustable in any desired direction. Practical handle and easy wiring system for 1.5m electrical cable.



6293-5K gr

CLASS II CE
 IP54
 LED 21W
 Die Cast Aluminum
 2000 Lumen

A+

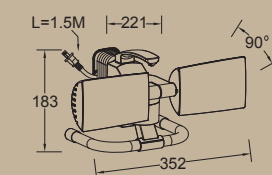



SECURY'LIGHT
connected camera concept

Launch of a complete new range of connected camera lights, with a focus on integrated security. Working with our own LUTEC APP running on your smartphone. This will make your outdoor life more personal, comfortable & safer.

camera light

SL



 **SECURY'LIGHT**
connected camera concept

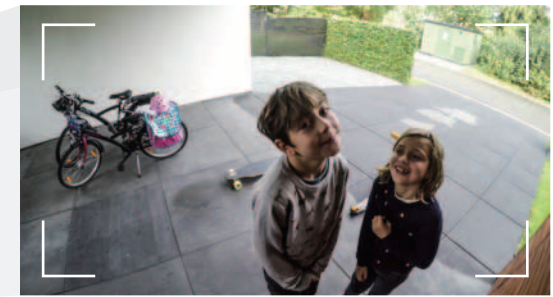
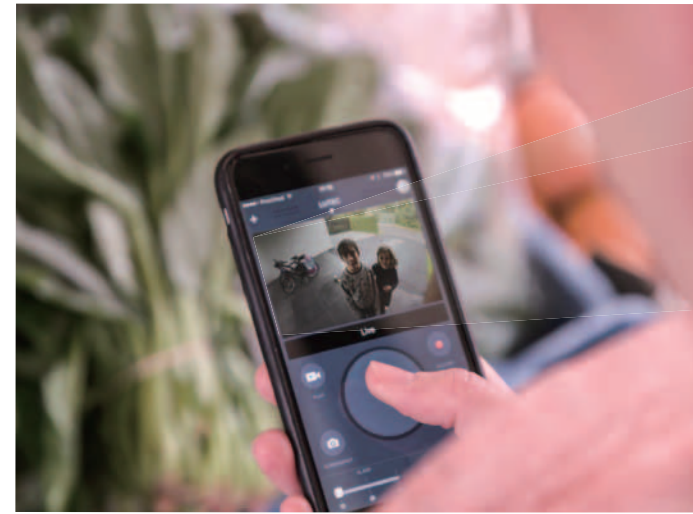

Have full control with the fully adjustable app.

Feel safe with the comfortable feeling that SECURY'LIGHT keeps an eye on your home.

With SECURY'LIGHT everything is under control.



Get live notifications from what's happening at your home. Talk to your visitors and feel secure.

You can even take a picture or record a video from wherever you are.

Listen and talk live with your visitors.



You can record a video or go back in time. And you can remotely set of an alarm buzzer.



Get an alert whenever someone approaches your home.

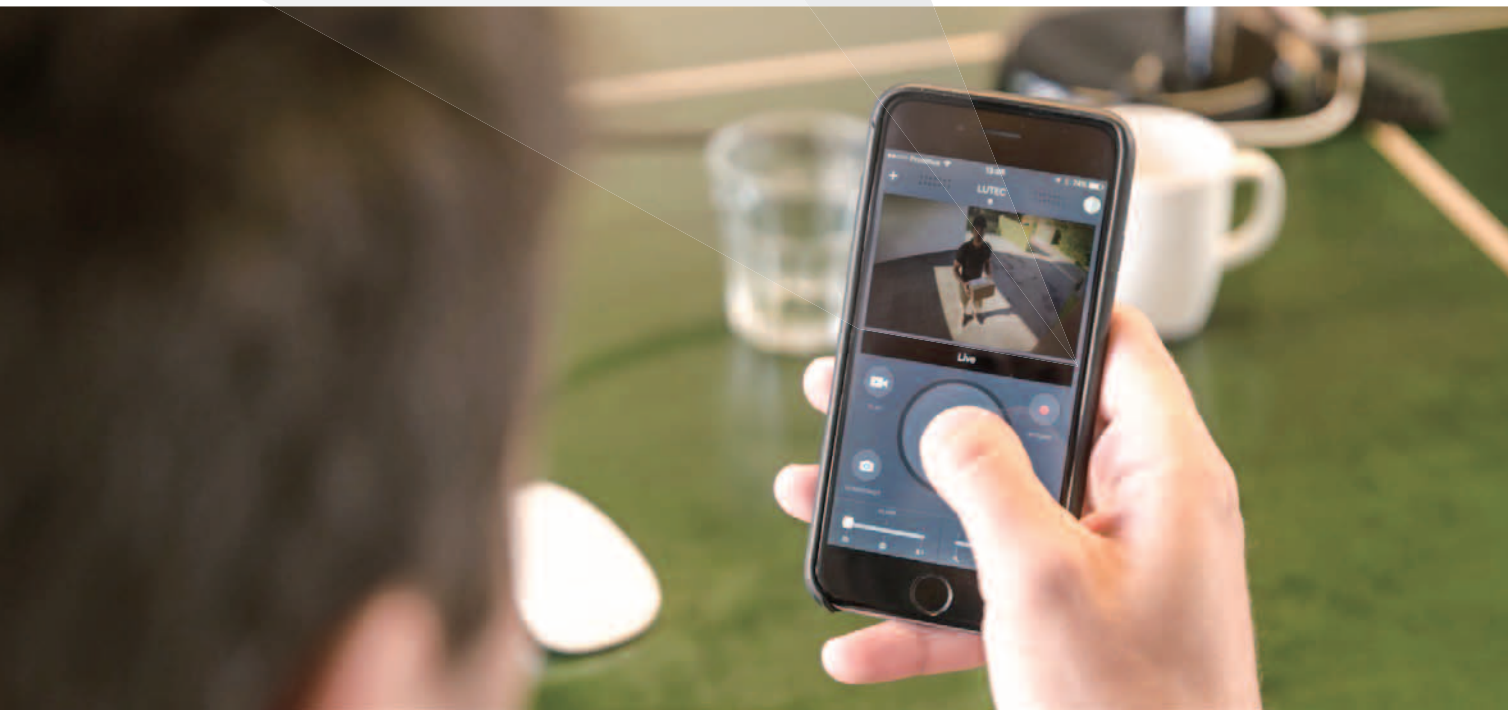

The light automatically jumps on where there is motion detected.

SECURY'LIGHT will keep an eye on your home

«When light meets a camera,
when light means security»



ALL CONTROLABLE IN ONE APP,
WHERE EVER, WHEN EVER.



Powerful and bright light with
the dimmable LED module



Sharp HD video recording with
wide angle light sensitive lens



Built-in noise cancelling microphone
with 2-way speaker buzzer



Infra-red motion sensor
fully adjustable in time,
distance and light mode



App with live notifications and video feed
Full control on all settings



Easy installation
WiFi connection

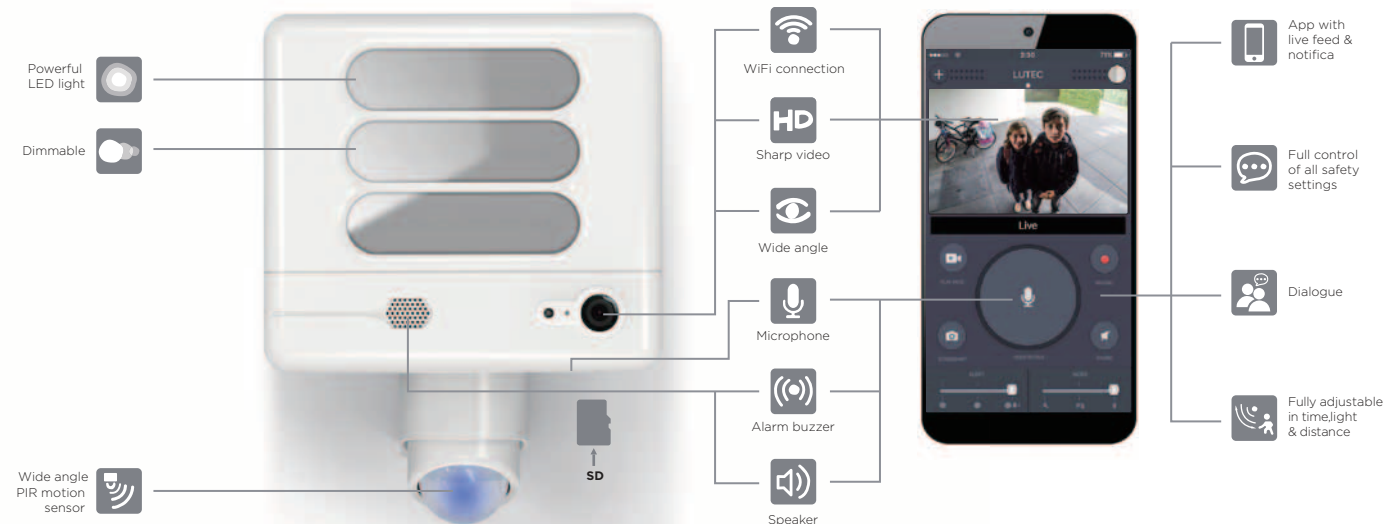

INSTALL

Quick install

DOWNLOAD

ENJOY

Pre-installation

- ① • Download the APP.
- ②
 - Ensure SECURY'LIGHT location has good Wi-Fi reception
 - Note: even small change in position can improve the reception

Set up

- ① →
- ②
 - Connect white red indicator light is flashing and after hearing "wait be configured"
- ③ →
- ④ →
- ⑤ →

Control

3 predefined presets for LOW-MEDIUM-HIGH security

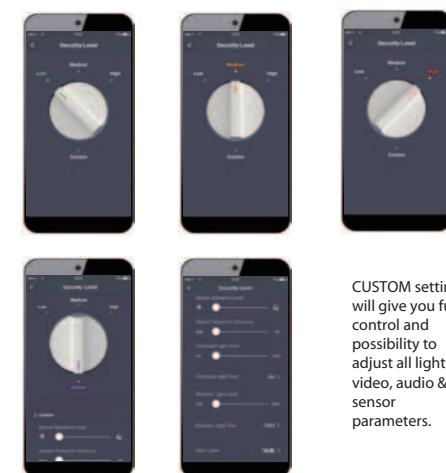

CUSTOM setting
will give you full
control and
possibility to
adjust all light,
video, audio &
sensor
parameters.

Support

Via the "support" button you can access to all further
Information & FAQ.



ESA

wall



Techno look projector in the SECURY'LIGHT range. Sleek design with 3 distinctive linear & diffuse beams. The automatic plug-in connection allows a simple & easy installation. Fully orientable over two axes . Up-Down & Left-Right Comes in white & dark grey colour.

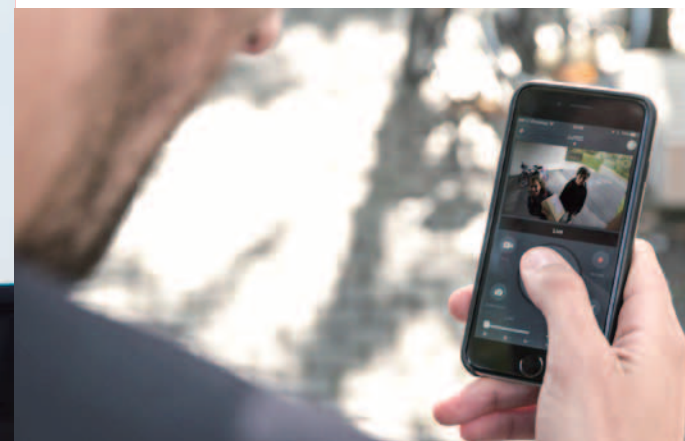

6255-CAM gr
6255-CAM wh

CLASS II CE
IP54
LED 25W
Die Cast Aluminum
1530 Lumen

A+

5000K

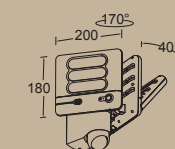

SENSOR

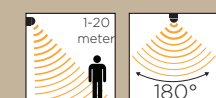

PERI

wall & ceiling



Rectangular floodlight in the SECURY'LIGHT range. Powerful LED light beam with a nice grid patter. The automatic plug-in connection allows a simple & easy installation. Fully orientable over two axes.Up-Down & Left-Right Comes in white & dark grey colour.



6295-CAM gr

CLASS II CE
IP44
LED 25W
Die Cast Aluminum
2120 Lumen

A+

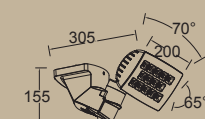
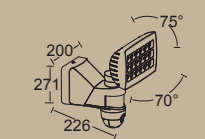

SENSOR

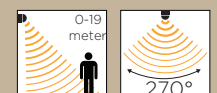

LIBRA

wall & ceiling



Double head projector in the SECURY'LIGHT range. The two "wings" feature a diffusor surface without edges, resulting in a perfectly homogeneous light beam. The automatic plug-in connection allows a simple & easy installation. The multiple orientation possibility gives you full flexibility to cover the desired area.

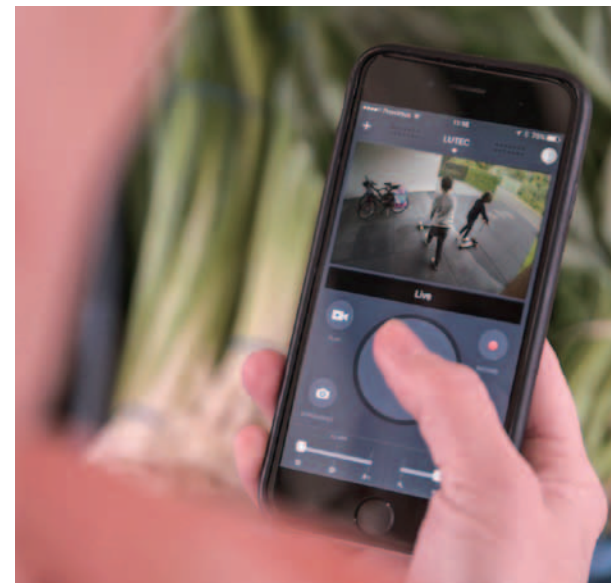

6324-CAM wh

CLASS II CE
IP44
LED 38W
Die Cast Aluminum
3000 Lumen

A*

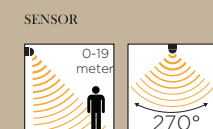
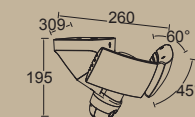
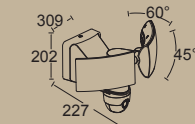

VESTA

wall



Stainless Steel wall light in the SECURY'LIGHT range. Elegant & sleek design with rectangular diffusor. Radiates in a warm white light without shadows. Camera, Speaker, Microphone & PIR motion sensor are fully integrated in the fixture.

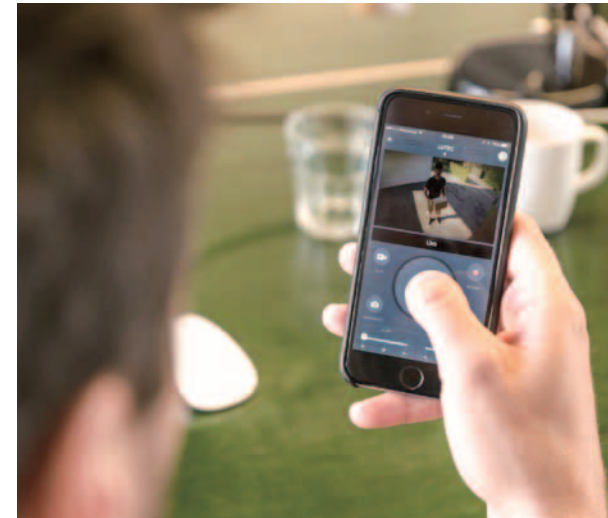

ST1906-CAM

CLASS I CE
IP54
LED 30W
Stainless Steel
1350 Lumen

A+

3000K

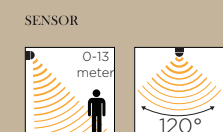

ELARA

wall



Tubular stainless steel wall light in the SECURYLIGHT range. Familiar design for entry-door application, with perfect finish and appropriate combination of the used materials.

Warm white LED light without shadows.

Camera, Speaker, Microphone & PIR motion sensor are fully integrated in the fixture.

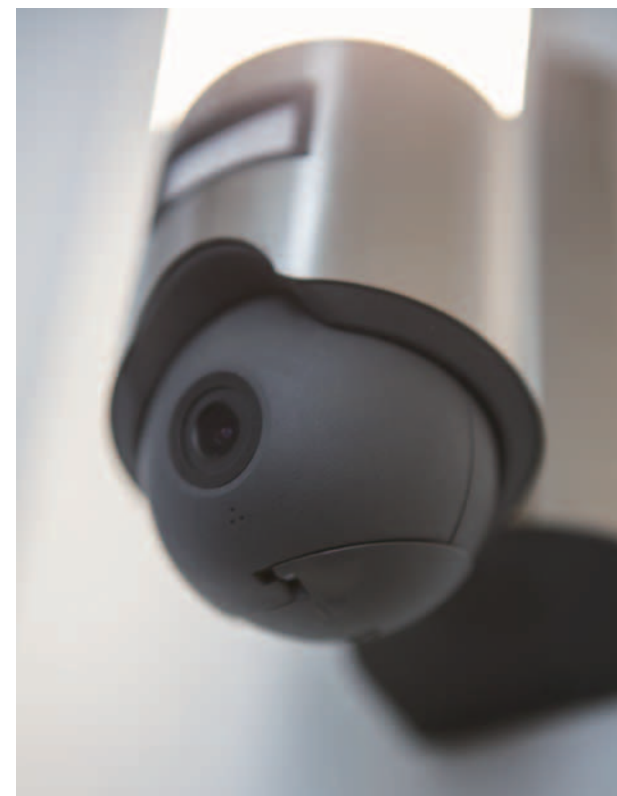
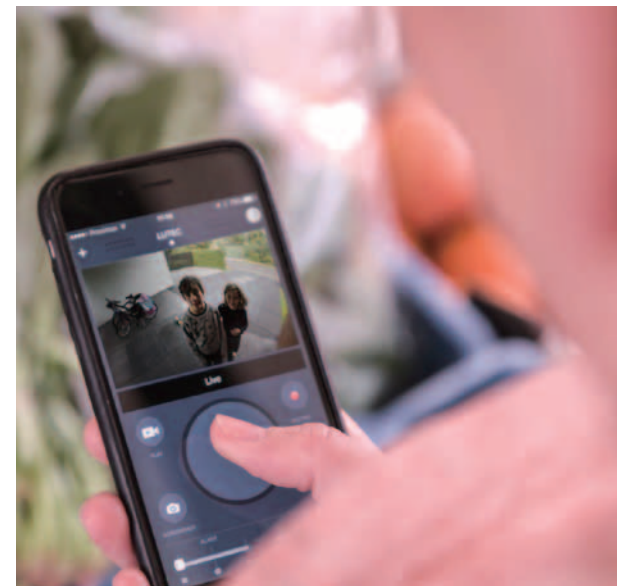

ST2671-CAM

CLASS II CE
IP44
LED 18W
Stainless Steel
1000 Lumen

A+

3000K



SENSOR

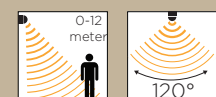

Functional



Functional

Under FUNCTIONAL ranges, we propose a number of essential lighting fixtures with a straight forward design. Ideal complements for functional applications like corridors, staircases, hall ways, entrance paths and facades. Most of the ranges come with an impact-proof polycarbonate opal diffuser resulting in a homogenous and strong light output without shadows. The recessed ranges for wall & ground are covering all standard applications. This with multiple light source possibilities and small, medium and large sizes.

wall
ceiling
recessed wall
recessed ground



FUNCTIONAL

WALL & CEILING

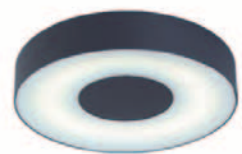

3481L UBLO / P248

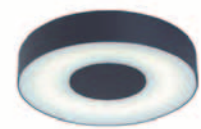

3481S UBLO / P250



3491L UBLO / P248



3491S UBLO / P250



3501L UBLO / P248



3501S UBLO / P250



3351 ORIGO / P252



3351S ORIGO / P252



3371 TITAN / P254



3372 TITAN / P254



3361 TITAN / P256



3362 TITAN / P256



3363 TITAN / P256



3172S TITAN / P258



3174S TITAN / P258



3381 SEINE / P260



3382 SEINE / P260



3383 SEINE / P260



3341S SEINE / P262



3342S SEINE / P262



3304 BONN / P264



ST3304 BONN / P264

RECESSED WALL



1831A VICTORIA / P266



1831B VICTORIA / P266



1831C VICTORIA / P266



1831D VICTORIA / P268



1829 CATANIA / P268



1821D-A MONTANA / P270



1822D MONTANA / P270

RECESSED GROUND



7005A BERLIN / P272



7005B BERLIN / P272



7042A CYDOPS / P274



7037A MERC / P276



7013 ARCTIC / P278



7007A LED SEATTLE / P280



7008A LED SEATTLE / P280



7008A REGINA / P282



7009A CHICAGO / P284

UBLO

wall & ceiling

Compact & elegant fixture producing a perfect uniform and homogenous warm white LED light without any shadow. Easy access to the connection part by removing click-on front plate.



3481L-3k si

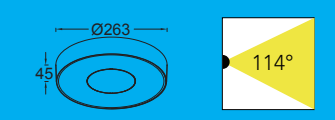

3491L-3k si

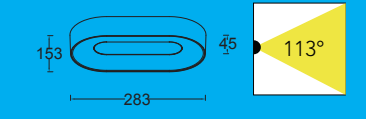

3501L-3k si

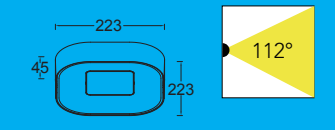

CLASS I Ⓢ
IP54
LED 11W
Die Cast Aluminum
570 Lumen

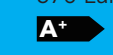

UBLO

wall & ceiling

Large size with same design & functionalities.
Double lumen output makes it very suitable for illuminating a large space.



3481S-3k si

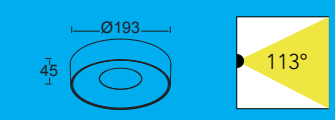

3491S-3k si

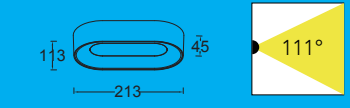

3501S-3k si

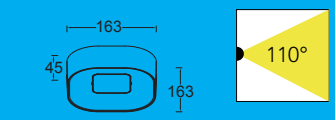

CLASS I CE
IP54
LED 6.3W
Die Cast Aluminum
280 Lumen
A+
3000K

ORIGO

wall & ceiling

The specific positioning of the opal polycarbonate diffuser creates a very nice glow behind surrounded by circular shadow. Small & medium size versions can easily be combined in your architectural projects. Now also available in LED integrated version.



3351-3K LED gr

CLASS I CE
IP54
LED 15W
830 Lumen
Die Cast Aluminum

A+

3000K

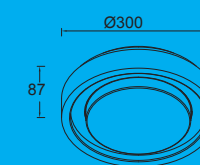

3351 si 3351 gr

CLASS I CE
IP54
E27 MAX 2*60W
Die Cast Aluminum

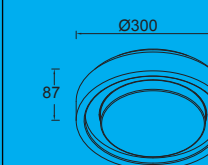

3351S gr

CLASS I CE
IP54
E27 MAX 60W
Die Cast Aluminum

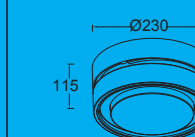

TITAN

wall & ceiling

Robust heavy duty die-cast aluminium fixture. This large model includes two traditional E27 fittings, suitable for energy saving bulbs, up to 20W, offering a very powerful light output. The soft glowing light effect behind creates an impression of floating.



3371 gr

CLASS I CE
IP54
E27 MAX 2*60W
Die Cast Aluminum

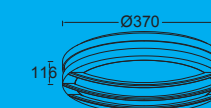

3372 gr

CLASS I CE
IP54
E27 MAX 2*60W
Die Cast Aluminum



TITAN

wall & ceiling

Medium sized wall & ceiling series available with 3 different decorative aluminium covers creating the desired effect for the location. With traditional Edison fitting, it is suitable for energy saving bulbs, up to 20W, . Easy installation with a standard loop in loop out wiring option.
Now also available in LED integrated version.

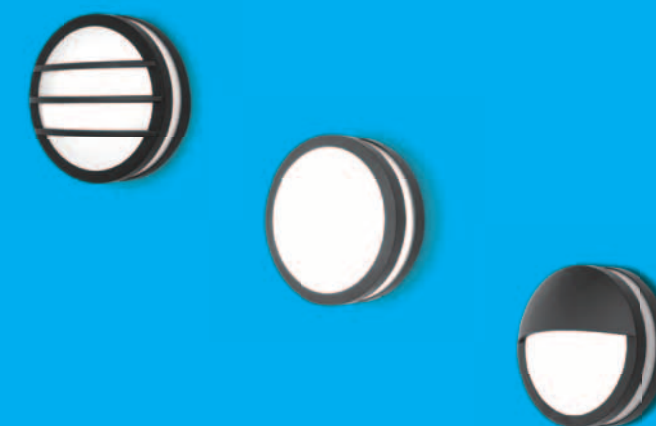

3361 si
3361 gr
CLASS I CE
IP54
E27 MAX 60W
Die Cast Aluminum

3362 si
3362 gr
CLASS I CE
IP54
E27 MAX 60W
Die Cast Aluminum

3363 gr
CLASS I
IP54
E27 MAX 60W
Die Cast Aluminum

3361-3K-LED gr
CLASS I CE
IP54
LED 16W
480 Lumen
Die Cast Aluminum

3362-3K-LED gr
CLASS I CE
IP54
LED 16W
480 Lumen
Die Cast Aluminum

3363-3K-LED gr
CLASS I CE
IP54
LED 16W
480 Lumen
Die Cast Aluminum

A+
3000K

A+
3000K

A+
3000K

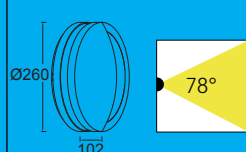
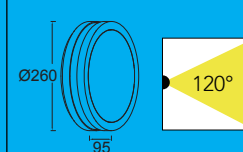
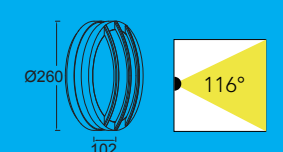

TITAN

wall & ceiling

Super compact wall & ceiling light, ideal to use for multiple light compositions on stairways, outside walls and terraces. The integrated LED light engine radiates a gentle warm white light without any shadows. The subtle glow to the back makes it complete.

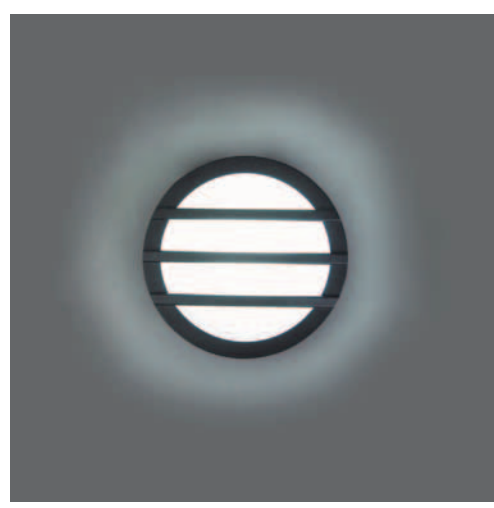

3172S-3K gr

CLASS I CE
IP54
LED 3W
145 Lumen
Die Cast Aluminum



3000K

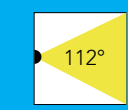
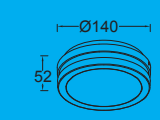

3174S-3K si
3174S-3K gr

CLASS I CE
IP54
LED 3W
145 Lumen
Die Cast Aluminum



3000K

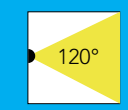
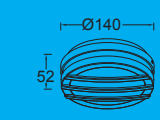

SEINE

wall & ceiling

Robust heavy duty die-cast aluminium fixture. This large model with two traditional E27 fittings, is suitable for energy saving bulbs of up to 20W offering a very powerful light output. The soft glowing light effect to the back creates a "floating" impression. Ideal for creating a safe atmosphere around your home at night.

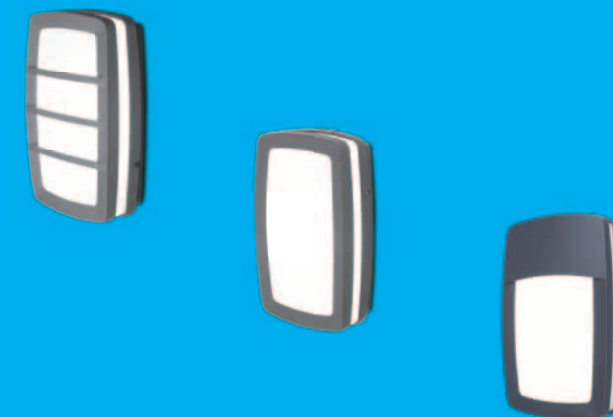

3381 si
3381 gr

CLASS I CE
IP54
E27 MAX 2*60W
Die Cast Aluminum



3382 si
3382 gr

CLASS I CE
IP54
E27 MAX 2*60W
Die Cast Aluminum

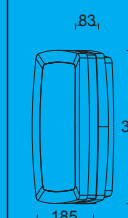

3383 gr

CLASS I CE
IP54
E27 MAX 2*60W
Die Cast Aluminum



SEINE

wall & ceiling

Super compact wall & ceiling light, the rectangular form can be well integrated in your modern architectural projects, especially when used in a multiple light compositions. The integrated LED light engine radiates a gentle warm white light without any shadows. The subtle glow to the back makes it complete.



3341S-3K si
3341S-3K gr

CLASS I CE
IP54
LED 4W
150 Lumen
Die Cast Aluminum
A+
3000K

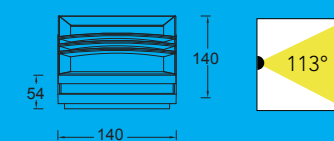

3342S-3K si
3342S-3K gr

CLASS I CE
IP54
LED 4W
180 Lumen
Die Cast Aluminum
A+
3000K

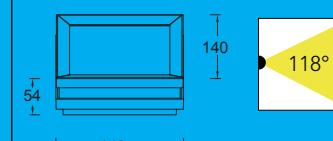

BONN

wall & ceiling

This elegant anthracite or stainless steel wall light fits in perfectly with your contemporary outdoor surrounding. It creates a perfect bi-directional light effect on your walls. The small vertical window in the front adds to the character. The traditional E27 fitting is suitable for energy saving bulbs but also for the latest LED retro-fit bulbs.



3304 gr

CLASS I CE
IP54
E27 60W
Die Cast Aluminum

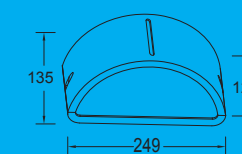

ST3304

CLASS II CE
IP54
E27 40W
Die Cast Aluminum

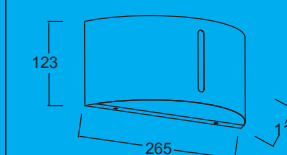

VICTORIA

recessed wall

Straight forward rectangular recessed wall light. The pre-installation of the base can be done before the finish or painting of your walls. Afterwards you only need to mount one of the three desired covers to make your project complete. The IP65 rating, protection against water jets, makes this article fully compliant for public & private projects.

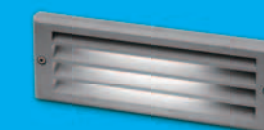
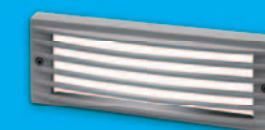

1831A LED gr

CLASS I CE
IP65
LED 10W
Die Cast Aluminum
250 Lumen

A+

4000K

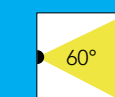
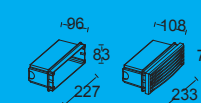

1831B LED gr

CLASS I CE
IP65
LED 10W
Die Cast Aluminum
460 Lumen

A+

4000K

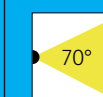
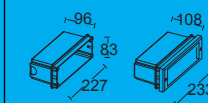

1831C LED gr

CLASS I CE
IP54
LED 10W
Die Cast Aluminum
100 Lumen

A+

4000K

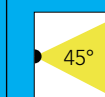
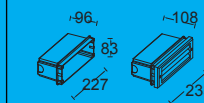

SEINE

recessed wall

The invisible recessed LED light engine creates a subtle indirect light effect by reflecting on the horizontally ribbed aluminium housing. Comes in anthracite or silver grey.



1829 LED gr

CLASS I CE
IP54
LED 16W
290 Lumen
Die Cast Aluminum

A+

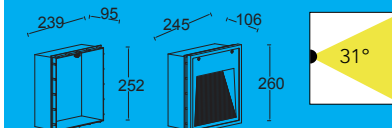

1831D LED gr

CLASS I CE
IP54
LED 3.5W
30 Lumen
Die Cast Aluminum

A+

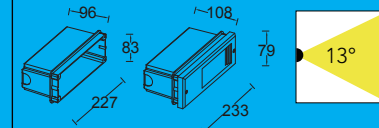
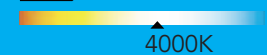

MONTANA

recessed wall

This rectangular wall light offers the possibility to combine a recessed version with a similar wall mounted version. The strong, efficient and long-lasting LED-engine together with the pre-mounting base option make this article the perfect solution for your professional outdoor projects.

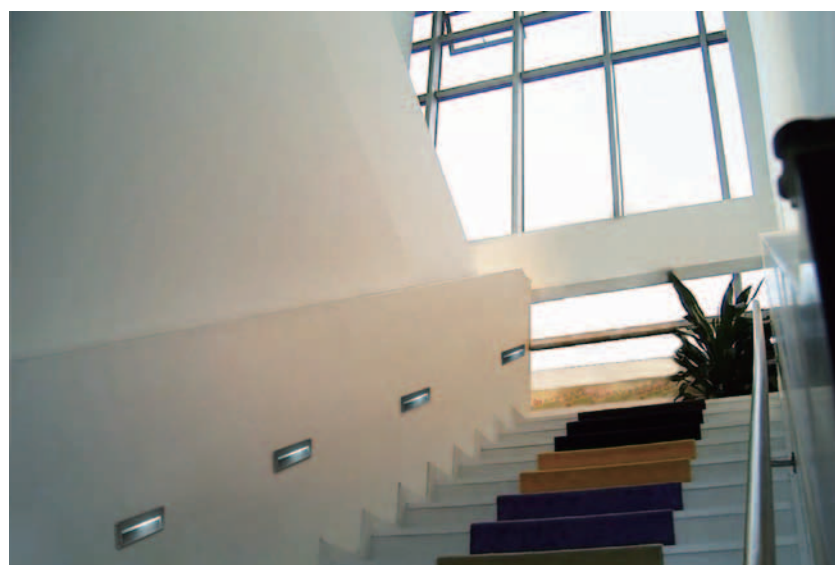

1821D-A LED si

CLASS I CE
IP54
LED 14W
330 Lumen
Die Cast Aluminum
A+

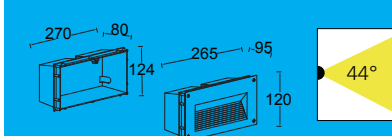

1822D LED gr

CLASS I CE
IP54
LED 14W
330 Lumen
Die Cast Aluminum
A+

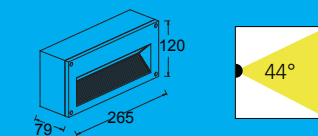

BERLIN

recessed ground

Round or square stainless recessed ground spot lights creating a nice effect to guide you along your driveway, pathway or terrace. Compact in size yet solid in construction, you can drive over it with your car.



7005A/B LED

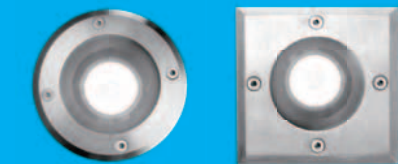

7005A/B GU10



2000kgs

7005A GU10

CLASS I CE
IP67
GU10 35W
11W CFL
Die Cast Aluminum
Stainless Steel

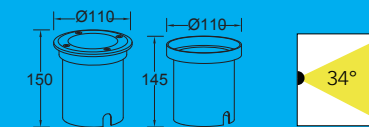

7005A LED

LED 5W
180 Lumen

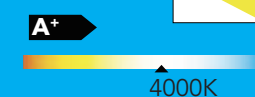

7005B GU10

CLASS I CE
IP67
GU10 35W
11W CFL
Die Cast Aluminum
Stainless Steel

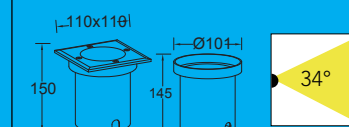

7005B LED

LED 5W
180 Lumen

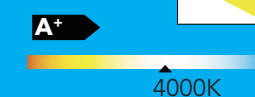

CYDOPS

recessed ground

Super compact stainless steel recessed ground spot with a wide angle. High light efficiency combined with only a shallow recess needed for installation makes this built-in spot perfectly suitable for your wooden terraces.



7042A

CLASS I CE
IP67
LED 6W
500 Lumen
Stainless Steel

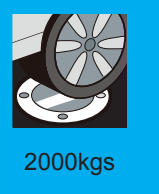
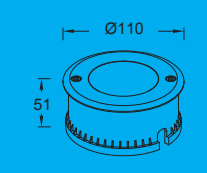
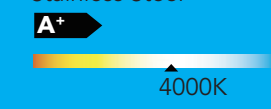

MERC

recessed ground

Ground spot with stainless steel cover, available in two sizes. The adjustable lamp holder gives the possibility to adjust the narrow beam angle. With this you will be able to give your trees full attention throughout the night.



*Adjustable lampholder



*Adjustable lampholder



2000kgs

7036A LED

CLASS I CE
IP67
LED 6W
560 Lumen
Die Cast Aluminum
A+

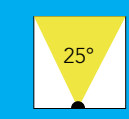
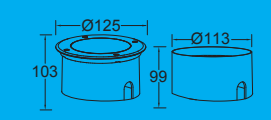

7037A LED

CLASS I CE
IP67
LED 18W
1290 Lumen
Die Cast Aluminum
A+

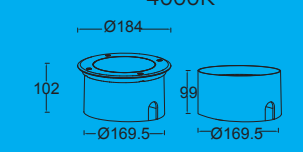

ARCTIC

recessed ground

Robust, powerful recessed LED ground spot. This spot can be raised to an angle of 75°. Pick out ornaments & features in your garden with a stunning light effect.

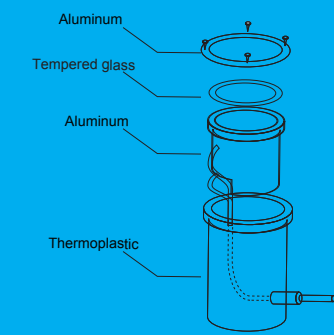

2000kgs

7013 LED

CLASS I CE
IP67
LED 16W
950 Lumen
Die Cast Aluminum

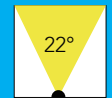
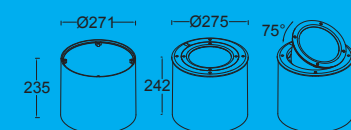
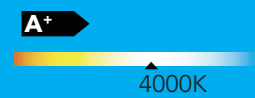

SEATTLE

recessed ground

Super powerful LED recessed ground spot with a high light efficacy. The beam angle is adjustable from a narrow to a wide beam. This spot will put your garden in a sea of light. The loop in loop out wiring option is available.



2000kgs

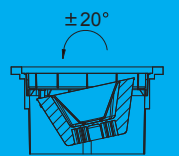

*Adjustable lampholder ±20°

7007A LED

CLASS I CE
IP67
1 COB LED 29W
2150 Lumen
Die Cast Aluminum
Stainless Steel

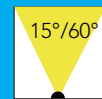
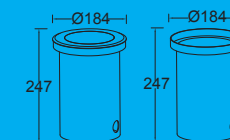

7008A LED

CLASS I CE
IP67
1 COB LED 35W
3000 Lumen
Die Cast Aluminum
Stainless Steel

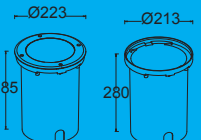

REGINA

recessed ground

Medium sized recessed ground spot with a traditional G12 fitting suitable for high pressure HID bulbs. Comes in a narrow and wide beam versions. Easy installation with a pre-mounting base and stainless steel cover to finish. Resistant and can be used on driveways.



*Adjustable lampholder



*Adjustable lampholder

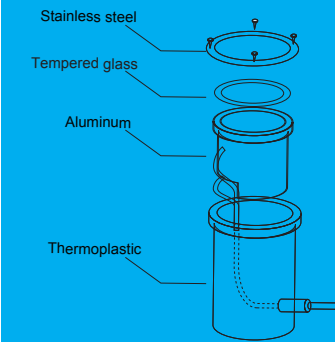
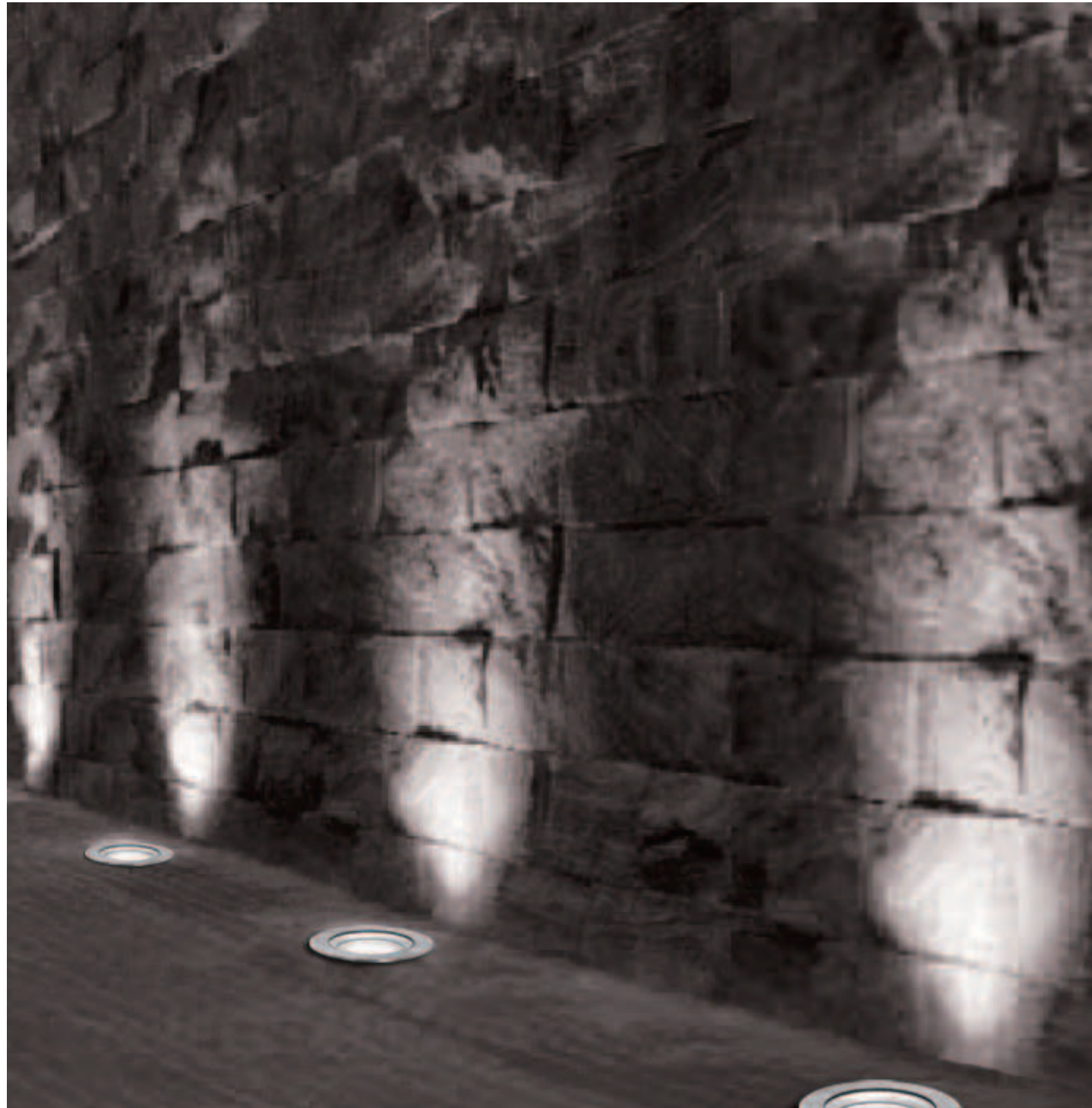

2000kgs



Anti-glare
(not suitable for LED versions)

7008A G12 N

CLASS I CE
IP67
G12 Narrow Beam 70W
Die Cast Aluminum
Stainless Steel

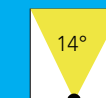
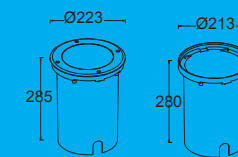

7008A G12 W

CLASS I CE
IP67
G12 Wide Beam 70W
Die Cast Aluminum
Stainless Steel

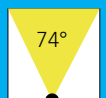
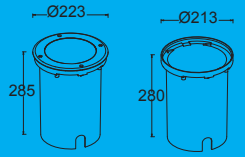

CHICAGO

recessed ground

Large sized ground spot with traditional R7S fitting suitable for a linear halogen lamp. The adjustable lamp holder allows the light beam angle to be modified. Easy installation with a pre-mounting thermoplastic base.



*Adjustable lampholder

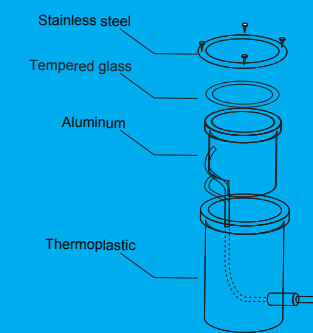

2000kgs

7009A

CLASS I CE
 IP67
 Rx7s Adjustable
 Reflector 150W
 Die Cast Aluminum
 Stainless Steel

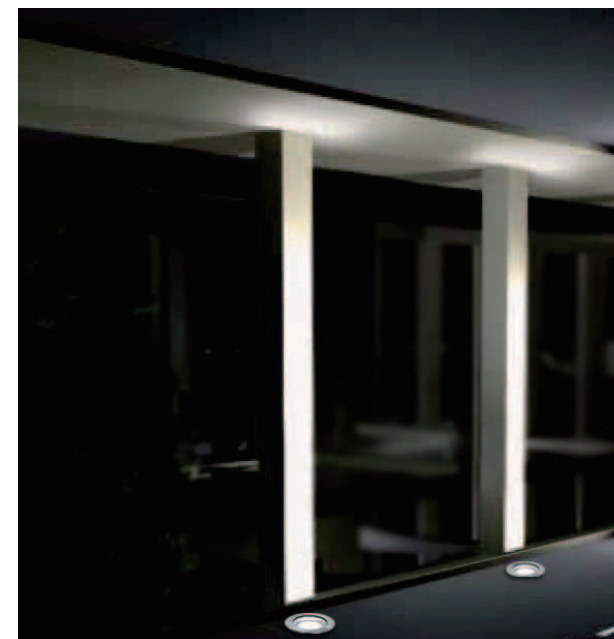
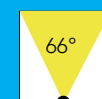
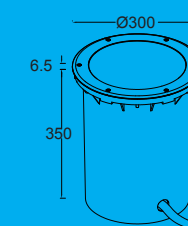

INTRODUCING OUR COMPANY

40 years of experience

The beginnings of a lighting company

Originally as a national aluminium die-cast factory, we acquired our first experience in outdoor lighting by producing bulkhead lights & classical garden lanterns.

Our quality standards met international standards and the first export shipment was made in 1996.

The new factory in the Far-East Industry park in Yuyao was operational in 2001, concentrating on modern garden & professional lighting resulting from a booming international DIY & ODM demand.

From 2009 a close collaboration with the Design(Pool) had two objectives. To create a stronger offer for the ODM market and to launch a base for our future brand LUTEC.

LUTEC was launched in 2010, focusing on architectural LED lights & introducing Solar Energy studies.

This has resulted in the opening of a second production facility in 2012, fully devoted to future developments.



Nowadays

Lighting is both essential and magic.

The challenge of lighting is to create products which are a balance between the shape impact and attractiveness, and real functional values of use. The LED revolution has completely changed the game, giving us a lot of new opportunities. Added to this we must follow the latest technical innovations but also anticipate and provoke them, especially with solar energy and lighting control processes.

To serve our objectives, we are reinforcing our international network and organisation: central warehouses in Germany and China, establishing partners in new countries, the building of our corporate identity and also developing many different brand supports.

Future is already here

Support the users

In our daily life we are surrounded by interactive and connected products. For many reasons it is evident for the lighting field to embrace this, among which is the ability to organise the light at will: temperature, color, control of the sensors, programming, energy saving and control, interactivity between several light points, security with camera, sound...

Our new APP, running on a smart phone, can help program and control all the information received through our products.



WELCOME TO THE LUTEC CENTER

Connected by lighting

The LUTEC centre is in our HQ in Yuyao. Located on the production site, it is an international meeting place where new concepts are elaborated, innovation & strategies are shared, discussed and studied.



We provide an expert platform in design, sales and services. We have the will to show and experiment different approaches creating choices for the short or medium terms. Staying close to our customers, which by extension also means the final consumers, allows the right design solutions to be found. Our team is trained for being reactive. The key to realize a win-win product is to always explore the possibilities, select and adapt, finding the adapted position.

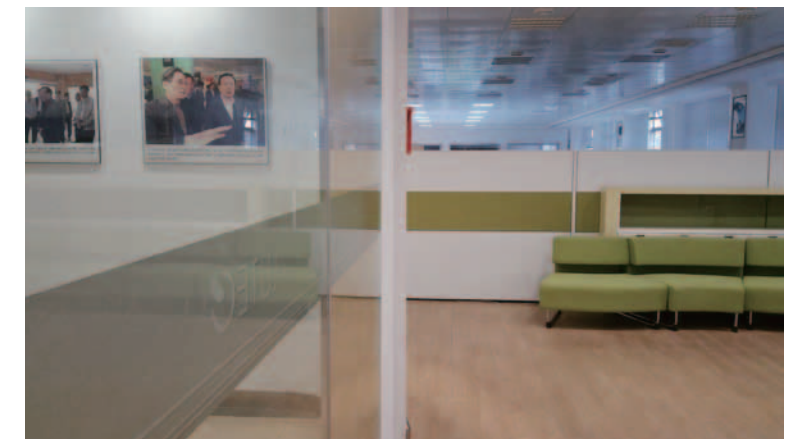

In our view innovation is always closely linked to a right level of realization.

LUTEC

It is true, LUTEC is a young brand but it is built on a strong manufacturing experience. Manufacturing involves imagination and efficiency.

Why we decided to establish a brand?

The brand gives us a needed visibility. The brand allows us to anticipate the market, to make our own choices related to trends and to make developments such as we perceive them through our partners in different countries.

Connected by lighting underlines our intention to develop products in accordance with the final consumers, through all our network and distribution channels.

Now becoming a major player in lighting field, our main objective is to consolidate our offer through creativity, the design which involves a real level of quality and services.

DESIGN & ENGINEERING

Design, engineering & manufacturing, all interactive.

One of the main decision we have taken in the LUTEC organisation is to break the walls between the different integrated services concerned by our product strategy. We have installed a culture of flowing communication between the services where everybody has a positive role to play in all projects. It works because we consider that we are all concerned in the success of a product.



We know that whatever the project it is complex and a number of obstacles have to be got through. To be as perfect as possible means working together: knowledge has to be shared at all levels. Creativity, marketing, engineering, production, communication, sales are all one and the same, totally linked.



WAREHOUSING & TRANSPORT

Global logistic footprint assuring availability & proximity.



Today, we stock all A-items (161 sku's with high rotation) in the China Central Warehouse. (CCW). In this way we can guarantee an immediate shipment from the Ningbo harbor all over the world. The B & C items are made to order with a clever spareparts replenish system behind.

CCW
China Central Warehouse
Yuyao - China

ECW
European Central Warehouse
Cologne - Germany

LUTEC

DB SCHENKER



Since 2014, the European Central Warehouse is fully operational. This warehouse is centrally situated in Europe and operated by our logistic partner DB Schenker. With a standard lead time of 1 week for all shipments to whatever place in Europe, the LUTEC articles are always within reach. We can offer different transport options: direct shipment, cross docking or pick-up, in close cooperation with our local Sales Cy & Distributors. Actually the ECW-portfolio contains the 150 best-running sku's.



With the LUTEC App, our Partners can consult in real time the stock situation in the CCW & ECW, plus the incoming shipments. This will lead to transparent and complete info towards our customers.

LUTEC Quality

As a global supplier, our products are fully compliant with all technical & quality requirements of the different regions in the world.



All LUTEC LED articles benefit from a 5-years functional warranty. For the SOLAR range we apply a standard 2 years functional warranty.)



Integrated LED Light-engines

We apply in our designs the most appropriate LED light engine. Thanks to the in-house engineering and manufacturing in combination with a good relation with A-brand component suppliers, we're constantly improving the performance of the total LED-module. This results in a higher lumen/watt ratio but also in an improvement of the lumen/dollar ratio.

Low Energy Cost : -80% Energy consumption vs traditional lightsources

Long Lifetime : up to 20.000 hours

LUTEC LED-light engines featuring the most appropriate characteristics in order to give the best result for all your outdoor applications.



The LED driver is the heart of the LED module and is the main influencer of the life-time. At LUTEC we develop these drivers according the engineering & design requirements. The manufacturing of the SMD's of these LUTEC-drivers is done on the in-house approved SMT assembly lines. In some cases we apply also drivers of A-brand suppliers. All drivers are compliant to all standard requirements and regulations. UL – GS- EMC-FCC-ERP

The LUTEC products are manufactured at the 100% controlled own production facilities and fully tested at the in-house approved lab



LUTEC works only with famous A-brand LED suppliers and strict requirements.

- Lumen Maintenance in time : 100% LM-80 test report
- Color deviation: 100% under 5-step MacAdam ellipse
- ERP compliant



The Light Color or Color Temperature in Kelvin (K) gives a clear indication about "whiteness" of the LED light.

Standard we apply the **4000K Daylight**. For most fixtures with diffuse light and vintage look a **3000K Warm White light** is installed. The more functional work & security projectors have an integrated LED source with a **5000K Cool White light**.

Color Temperature in Kelvin Scale

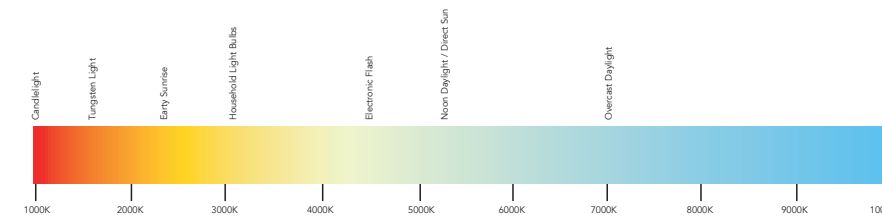

The **Color Rendering Index (CRI)** gives on a 0-100 scale an indication the color accuracy.

Determining the ability of the light source to reveal the colors of the object faithfully in comparison with a natural light source. In all LUTEC fixtures we apply a CRI of minimum 80%. For Outdoor applications this is a more than satisfying level.

The **Luminous Flux** of an Outdoor fixture indicated in an nbr of **Lumen**. (lm) is the total amount of light which comes out of the fixture in all directions. It gives a good measure of the **brightness** you can expect. This Lumen indication replaces on a clearer manner the previously used wattage.

Brightness	220+	400+	700+	900+	1300+
Standard	25 W	40 W	60 W	75 W	100 W
Halogen	18 W	28 W	42 W	53 W	70 W
CFL	6 W	9 W	12 W	15 W	20 W
LED	4 W	6 W	10 W	13 W	18 W

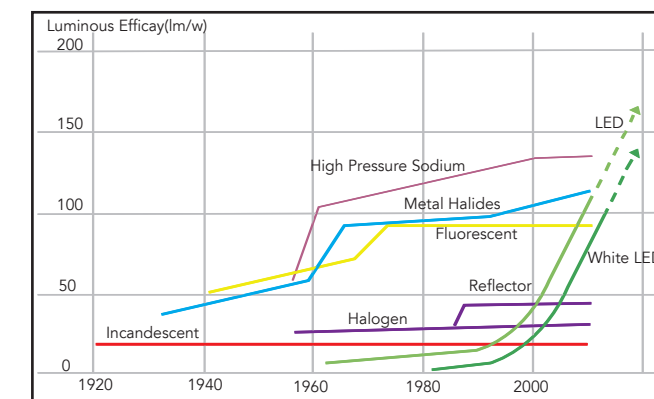

The Luminous Efficacy in Lumens/Watt gives a good measure of the optimal conversion of the electrical power into useful light. This is an important parameter with direct impact on the electric energy cost for your installation. Thanks to the continuous developments the LED solution is already today one of the most efficient light technologies. The Luminous Efficacy is one of the main parameters for the determination of the Energy Efficiency class.

According the EU regulation no 874/2012, about energy labelling of electrical lamps and luminaires, it's required that the consumers are informed about the Energy Efficiency class.
For all LUTEC articles this information is available on our website www.lutec.net.

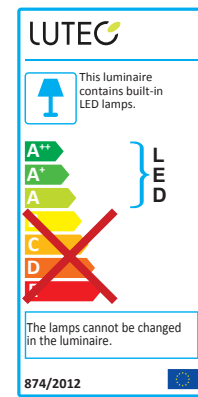

All the LUTEC LED- fixtures featuring an **Energy Efficiency class A+ or better.**



Materials & finishes

For all LUTEC luminaires we apply the most appropriate high quality materials & finishes, all with an excellent weather proofness & mechanical strength to ensure a long lifetime.

Heavy duty die-cast Aluminum type ADC 12. Thickness of 2mm and a very good compactness, no air holes inside. In house fully automatic powder-coating & water painting-installation giving a perfect protection against corrosion.

LUTEC benefits from an in-house tooling workshop both for aluminum & synthetic components. This great asset & experience assures a high quality production.

Different types of **premium Stainless Steel**.

For the ground recessed spots : 304 & 316 standards. For the wall & bollard versions : 201 & 202.

Electrophoretic painting resulting in an extra protection layer.

Different kind of **durable synthetics**, depending on the application and form factors. For the fixtures: in most cases ABS, this is a strong, light-weighted material and can be used under low and high outdoor temperatures. For the diffusers: the impact proof and very resistant PC (polycarbonate) is used in opal or transparent version. Also clear glass, tempered glass and opal or clear PMMA (plexi-glass) are common in our designs.



IP rating Table

Protection against solids		Protection against liquids	
0	Not Protected	0	Not Protected
1	Protected against Solid Objects greater than 50mm	1	Protected against Dripping Water
2	Protected against Solid Objects greater than 12mm	2	Protected against Dripping Water when tilted to 15°
3	Protected against Solid Objects greater than 2.5mm	3	Protected against Spraying Water
4	Protected against Solid Objects greater than 1mm	4	Protected against Splashing Water
5	Dust Protected	5	Protected against Water Jets
6	Dust Tight	6	Protected against Heavy Seas
		7	Protected against the effects of Immersion
		8	Protected against Submersion

The LUTEC Outdoor fixture comply to the International standards concerning **Ingress Protection**. All articles have a minimum IP44 rate. For some specific applications (Ex. in ground recessed spots) the protection rate goes up to IP67.

Mounting, installation & maintenance

LUTEC pays a lot of attention to a consumer friendly mounting and foresee a variety of application possibilities, enhanced by specific & clever user-interfaces. Every LUTEC Outdoor fixture has a clear **instruction manual**. The mounting and the installation is easy and fast. No specific tools are needed.

Service network available on global level through LUTEC Partners.



SECURITY LIGHT
connected camera concept

ESA 6255-CAM

«When light meets a camera, when light means security»

Service:

LUTEC in FRANCE +33-04-75602568	LUTEC in UK +44-1993-760870	LUTEC in ITALY +39-031-353522
LUTEC in IBERIA +34-93-5001221	LUTEC in BNL +32-3-454-01-09	LUTEC in HUNGARY +36-30-2193952
LUTEC in ROMANIA +40-234-562-452	LUTEC in RUSSIA +7-499-5501529	LUTEC in GREECE +30-2104817321
LUTEC in UKRAINE +38 (044) 496-74-83	LUTEC in DACH-ECO-LIGHT Leuchten GmbH +49-228-9691090 Bücheler Weg 27 - D-53347 Alfter	

Are members of LUTEC Group
CN8, Far East Industry Park, Yuyao, China
Service@lutec.net www.lutec.net

LUTEC
CONNECTED BY LIGHTING

Color Indication

	Code	Color Indication
●	gr	Anthracite Grey
●	si	Silver Grey
●	ss	Stainless Steel
●	wh	White
●	bl	Black
●	grn	Green
●	or	Orange
●	prp	Purple
●	ye	Yellow
●	br	Black-Rust

The **maintenance** of a LUTEC LED Outdoor fixture is fairly convenient. No bulb change needed thanks to integrated LED technology. In aggressive surroundings (close to the sea, industrial areas), clean the fixture regularly with a soft dry cloth.

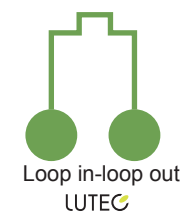

For a convenient multi-installation of the outdoor lights, a loop in- loop out for the electrical cable connection is foreseen in most of the articles.

LUTEC

CONNECTED BY LIGHTING

The LUTEC corporate identity has been reinforced with the constant implementation of a new visual identity and brand strategy.

New trade support tools are developed and used by our customers, creating an added value and differentiation versus our competitors.

LUTEC packaging



The new LUTEC packaging is now fully implemented over the complete portfolio. The look of the packaging is fresh and vivid giving the consumer immediately the right information and inspiration.

The product is the leader and gets the full attention with a clear picture. The renewed LUTEC logo covers all angles in the top corner, resulting in a uniform and clear brand recognition. The most relevant decision making characteristics are shown in big size on the front, top and second side. In this way the packaging is suitable to any position in the shelves. On the back side the complete technical information is shown in a logical and clear way.



LUTEC rich content

We have created a large database with all kind of "rich content": Atmosphere pictures, Video's, Tutorials,... This can be used for all kind of commercial & advertorial purposes. Also on-line pages will get in this way the complete & dynamic content to inform & inspire the consumers about the LUTEC propositions.



Secury Light Video

Mini Butterfly Video

Sunconnec Video

LUTEC in store support

Based on consumer insights and requests from our customers, we're proposing a large number of in store support tools. Always starting from the same idea : the product is king, the consumer should be guided in a clear way facilitating his selection in a convenient way.

Carton Promo-displays, easy to install, fully pre-packed with an informative top card.



45x45x160 cm

Action displays for promo-zones, including an attractive expo-board indicating the major characteristics plus a mounted and lighted product sample.



1/2 pallet

Inspiring shelf presentations. Showing in a pleasant and attractive way the product characteristics and the diverse application possibilities



Stand alone island displays . Ideal solution for second placement or seasonal activity, enhancing the right atmosphere and inspiration for all shoppers.



1/4 pallet

1/2 pallet

Reference Numbers A: (AS PER ITEM NO.)

NEW ITEM	NAME	PAGE	NEW ITEM	NAME	PAGE	NEW ITEM	NAME	PAGE
1821D-A	MONTANA	P270	3363	TITAN	P256	7005B LED	BERLIN	P272
1822D	MONTANA	P270	3371	TITAN	P254	7007A LED	SEATTLE	P280
1829	CATANIA	P268	3372	TITAN	P254	7008A G12	REGINA	P282
1831A	VICTORIA	P266	3381	SEINE	P260	7008A LED	REGINA	P280
1831B	VICTORIA	P266	3382	SEINE	P260	7009A	CHICAGO	P284
1831C	VICTORIA	P266	3383	SEINE	P260	7013 LED	ARCTIC	P278
1831D	VICTORIA	P268	3481L	UBLO	P248	7036A LED	MERC	P276
1836	CITY	P66	3481S	UBLO	P250	7037A LED	MERC	P276
1838S	DELTA	P68	3491L	UBLO	P248	7042A	CYDOPS	P274
1843	BOX CUBE	P62	3491S	UBLO	P250	8012-SL	PILLAR	P200
1846	BOX CUBE	P62	3501L	UBLO	P248	8091	HAMBURG	P214
1849	ORIGO	P60	3501S	UBLO	P250	9047	HONEY	P196
1853	CLIP	P64	32642AF4	CATE	P132	9048	HONEY DECK	P198
1857	STARRY	P126	6101S-PIR	NEVADA	P216	9049	LOOP DECK	P198
1860	EYES	P74	6101S-PIR SL	NEVADA	P180	P2282S-SL	GLOBE	P202
1860L	EYES	P74	6102S-PIR	NEVADA	P216	P6221A-PIR23	SHRIMP II	P212
1861	EYES	P76	6102S-PIR SL	NEVADA	P180	P9000	POLE	P170
1862	EVANS	P86	6040	FOCUS	P106	P9003	MINI BUTTERFLY	P144
1863	EVANS	P86	6041	FOCUS	P106	P9011	ZETA	P166
1865	RADIUS	P78	6042	FOCUS	P108	P9012	TILLY	P172
1866	RADIUS	P78	6048	FOCUS	P108	P9013	DROP	P168
1868	EYES	P76	6050	FOCUS	P110	P9014	GHOST SOLAR	P164
1869	PILO	P84	6051	FOCUS	P110	P9015	BREAD	P154
1871	MASK	P82	6141-1	CYLIN	P12	P9016	SUNSHINE	P174
1872	MASK	P82	6142-1	CYLIN	P14	P9019	OPENY	P176
1876	CONE	P32	6142-2	CYLIN	P14	P9034	ZERTA	P152
1876S	CONE	P32	6144-1	LEDSPOT	P6	P9035C	BUMP	P146
1877S	CONE	P30	6144S-1	MINI LEDSPOT	P2	P9036	FLAM	P188
1879	SPLIT	P88	6144S-1-PIR	MINI LEDSPOT	P4	P9037	STACK	P194
1880L	GHOST	P42	6144S-1-SL	MINI LEDSPOT	P150	P9037-450	STACK	P194
1880S	GHOST	P42	6144-2	LEDSPOT	P6	P9040	LORD	P148
1881S	GHOST	P42	6144S-2	MINI LEDSPOT	P2	P9041	DRAGONFLY	P142
1882	SIDWY	P80	6144S-2-PIR	MINI LEDSPOT	P4	P9044	MATRA	P178
1890M	GEMINI	P92	6144S-2-SL	MINI LEDSPOT	P150	P9052	SPARTA	P185
1890S	GEMINI	P92	6146-2	LEDSPOT	P10	P9053	GREEN BALL	P186
1891S	GEMINI	P90	6146S-1	MINI LEDSPOT	P8	P9054	PIR SENSOR	P186
1894	EVEN	P56	6146S-2	MINI LEDSPOT	P8	P9067	DISO	P162
1895	ZERTA	P70	6156-PIR	CORN	P204	P9067-450	DISO	P162
1896	TONA	P72	6160	EGGO	P18	P9077	PADLIGHT	P140
1896-PIR	TONA	P72	6161	EGGO	P20	P9080	TABLE CUBE	P136
1899	SECO	P58	6163	MERIDIAN	P26	P9080-450	TABLE CUBE	P138
11876N3	CONE	P34	6163S	MERIDIAN	P26	P9085	BRICK	P158
12603H4	UNITE	P122	6163S-PIR	MERIDIAN	P26	ST031051	FLAT	P50
12642H	CATE	P132	6164-730	MERIDIAN	P28	ST031052	FLAT	P50
2251M	SPRIL	P38	6164S-730	MERIDIAN	P28	ST033023	LUCA	P98
2251S	SPRIL	P36	6166	ARMOR	P48	ST033071	FACE	P54
2252M	SPRIL	P40	6167	ARMOR	P48	ST033071-PIR	FACE	P54
2252S	SPRIL	P40	6170	NEGARA	P218	ST1891S	GEMINI	P90
2253M	SPRIL	P38	6170-PIR	NEGARA	P218	ST1906-CAM	VESTA	P244
2253S	SPRIL	P36	6170S	NEGARA	P220	ST2671-CAM	ELARA	P246
2256S	GHOST	P44	6170-SP	NEGARA	P218	ST3304	BONN	P264
2257S	GHOST	P46	6170S-PIR	NEGARA	P220	ST5001	SLIM	P52
2401S	ZOE	P116	6170S-SP	NEGARA	P220	ST5001-PIR	SLIM	P52
2411	HOM	P128	6219A	SHRIMP I	P210	ST5108	LUCA	P98
2501	CANDLE	P130	6219A-PIR	SHRIMP I	P210	ST5212	CRYSTAL	P96
2521S	ANDA	P22	6223	OWL	P232	ST5214	TUBE	P94
2522S	ANDA	P24	6224	OWL	P232	ST5215	TUBE	P94
2592	JADE	P134	6225	COLLA	P230	ST5216	CRYSTAL	P96
2601	UNITE	P120	6226	ADO	P222	ST5218	BILAYER	P100
2601-PIR	UNITE	P120	6229	FRONT	P228	ST5219	BILAYER	P100
2602	UNITE	P120	6229-800	FRONT	P228	ST6040	FOCUS	P112
2604	UNITE	P122	6230	FRONT	P228	ST6041	FOCUS	P112
2612S	POSI	P118	6231-PIR	SHRIMP II	P212	ST6050	FOCUS	P114
2631S	LADI	P124	6243	ZIPO	P224	ST6051	FOCUS	P114
2642	CATE	P132	6255-CAM	ESA	P238	ST6057	PATH	P102
21876N3	CONE	P34	6260	TRUMPET	P16	ST6057-PIR	PATH	P102
3172S	TITAN	P258	6261A	TRUMPET	P16	ST6058	PATH	P104
3174S	TITAN	P258	6290	PERI	P234	ST6058-PIR	PATH	P104
3304	BONN	P264	6293	PERI	P236	ST9038	MINIS	P192
3341S	SEINE	P262	6294-PIR/6295-PIR	PERI	P206	ST9038-580	MINIS	P192
3342S	SEINE	P262	6295-CAM	PERI	P240	ST9039	KIWA	P190
3351S	ORIGO	P252	6297	UTIN	P226	ST9039-525	KIWA	P190
3351	ORIGO	P252	6322-PIR	ARC	P208	ST9079	SOLSTEL	P160
3361	TITAN	P256	6324-CAM	LIBRA	P242	ST9079-450	SOLSTEL	P160
3362	TITAN	P256	7005A LED	BERLIN	P272	ST9087	BUBBLE	P156

Reference Numbers A: (AS PER SERIES NAME)

NAME	NEW ITEM	PAGE	NAME	NEW ITEM	PAGE	NAME	NEW ITEM	PAGE
ADO	6226	P222	GEMINI	ST1891S	P90	PILLAR	8012-SL	P200
ANDA	2521S	P22	GEMINI	1890S	P92	PILO	1869	P84
ANDA	2522S	P24	GEMINI	1890M	P92	PIR SENSOR	P9054	P186
ARC	6322-PIR	P208	GHOST	1881S	P42	POLE	P9000	P170
ARCTIC	7013 LED	P278	GHOST	1880S	P42	POSI	2612S	P118
ARMOR	6166	P48	GHOST	1880L	P42	RADIUS	1865	P78
ARMOR	6167	P48	GHOST	2256S	P44	RADIUS	1866	P78
BERLIN	7005A LED	P272	GHOST	2257S	P46	REGINA	7008A LED	P280
BERLIN	7005B LED	P272	GHOST SOLAR	P9014	P164	REGINA	7008A G12	P282
BILAYER	ST5218	P100	GLOBE	P2282S-SL	P202	SEATTLE	7007A LED	P280
BILAYER	ST5219	P100	GREEN BALL	P9053	P186	SECO	1899	P58
BONN	ST3304	P264	HAMBURG	8091	P214	SEINE	3381	P260
BONN	3304	P264	HOM	2411	P128	SEINE	3382	P260
BOX CUBE	1846	P62	HONEY	9047	P196	SEINE	3383	P260
BOX CUBE	1843	P62	HONEY DECK	9048	P198	SEINE	3341S	P262
BREAD	P9015	P154	JADE	2592	P134	SEINE	3342S	P262
BRICK	P9085	P158	KIWA	ST9039	P190	SHRIMP I	6219A	P210
BUBBLE	ST9087	P156	KIWA	ST9039-525	P190	SHRIMP I	6219A-PIR	P210
BUMP	P9035C	P146	LADI	2631S	P124	SHRIMP II	6231-PIR	P212
CANDLE	2501	P130	LEDSPOT	6144-1	P6	SHRIMP II	P6221A-PIR23	P212
CATANIA	1829	P268	LEDSPOT	6144-2	P6	SIDWY	1882	P80
CATE	2642	P132	LEDSPOT	6146-2	P10	SLIM	ST5001	P52
CATE	12642H	P132	LIBRA	6324-CAM	P242	SLIM	ST5001-PIR	P52
CATE	32642AF4	P132	LOOP DECK	9049	P198	SOLSTEL	ST9079	P160
CHICAGO	7009A	P284	LORD	P9040	P148	SOLSTEL	ST9079-450	P160
CITY	1836	P66	LUCA	ST5108	P98	SPARTA	P9052	P185
CLIP	1853	P64	LUCA	ST033023	P98	SPLIT	1879	P88
COLLA	6225	P230	MASK	1871	P82	SPRIL	2253S	P36
CONE	1877S	P30	MASK	1872	P82	SPRIL	2251S	P36
CONE	1876S	P32	MATRA	P9044	P178	SPRIL	2253M	P38
CONE	1876	P32	MERC	7036A LED	P276	SPRIL	2251M	P38
CONE	11876N3	P34	MERC	7036A LED	P276	SPRIL	2252S	P40
CONE	21876N3	P34	MERCIDIAN	6163S	P26	SPRIL	2252M	P40
CORN	6156-PIR	P204	MERCIDIAN	6163S-PIR	P26	STACK	P9037	P194
CRYSTAL	ST5212	P96	MERCIDIAN	6164S-730	P28	STACK	P9037-450	P194
CRYSTAL	ST5216	P96	MERCIDIAN	6163	P26	STARRY	1857	P126
CYDOPS	7042A	P274	MERCIDIAN	6164-730	P28	SUNSHINE	P9016	P174
CYLIN	6141-1	P12	MINI BUTTERFLY	P9003	P144	TABLE CUBE	P9080	P136
CYLIN	6142-1	P14	MINI LEDSPOT	6144S-1	P2	TABLE CUBE	P9080-450	P138
CYLIN	6142-2	P14	MINI LEDSPOT	6144S-2	P2	TILLY	P9012	P172
DELTA	1838S	P68	MINI LEDSPOT	6144S-1-PIR	P4	TITAN	3371	P254
DISO	P9067	P162	MINI LEDSPOT	6144S-2-PIR	P4	TITAN	3372	P254
DISO	P9067-450	P162	MINI LEDSPOT	6146S-1	P8	TITAN	3361	P256
DRAGONFLY	P9041	P142	MINI LEDSPOT	6146S-2	P8	TITAN	3362	P256
DROP	P9013	P168	MINI LEDSPOT	6144S-1-SL	P150	TITAN	3363	P256
EGGO	6160	P18	MINI LEDSPOT	6144S-2-SL	P150	TITAN	3172S	P258
EGGO	6161	P20	MINIS	ST9038	P192	TITAN	3174S	P258
ELARA	ST2671-CAM	P246	MINIS	ST9038-580	P192	TONA	1896	P72
ESA	6255-CAM	P238	MONTANA	1821D-A LED	P270	TONA	1896-PIR	P72
EVANS	1862	P86	MONTANA	1822D LED	P270	TRUMPET	6260	P16
EVANS	1863	P86	NEGARA	6170	P218	TRUMPET	6261A	P16
EVEN	1894	P56	NEGARA	6170-SP	P218	TUBE	ST5214	P94
EYES	1860	P74	NEGARA	6170-PIR	P218	TUBE	ST5215	P94
EYES	1860L	P74	NEGARA	6170S	P220	UBLO	3481S	P250
EYES	1861	P76	NEGARA	6170S-SP	P220	UBLO	3481L	P248
EYES	1868	P76	NEGARA	6170S-PIR	P220	UBLO	3491S	P250
FACE	ST033071	P52	NEVADA	6101S-PIR SL	P180	UBLO	3491L	P248
FACE	ST033071-PIR	P52	NEVADA	6102S-PIR SL	P180	UBLO	3501S	P250
FLAM	P9036	P188	NEVADA	6101S-PIR	P216	UBLO	3501L	P248
FLAT	ST031051	P50	NEVADA	6102S-PIR	P216	UNITE	2602	P120
FLAT	ST031052	P50	OPENY	P9019	P176	UNITE	2601	P120
FOCUS	6040	P106	ORIGO	1849	P60	UNITE	2601-PIR	P120
FOCUS	6041	P106	ORIGO	3351	P252	UNITE	2604	P122
FOCUS	6042	P108	ORIGO	3351S	P252	UNITE	12603H4	P122
FOCUS	6048	P108	OWL	6224	P232	UTIN	6297	P226
FOCUS	6050	P110	OWL	6223	P232	VESTA	ST1906-CAM	P244
FOCUS	6051	P110	PADLIGHT	P9077	P140	VICTORIA	1831A LED	P266
FOCUS	ST6040	P112	PATH	ST6057	P102	VICTORIA	1831B LED	P266
FOCUS	ST6041	P112	PATH	ST6057-PIR	P102	VICTORIA	1831C LED	P266
FOCUS	ST6050	P114	PATH	ST6058	P104	VICTORIA	1831D LED	P268
FOCUS	ST6051	P114	PATH	ST6058-PIR	P104	ZERTA	1895	P70
FRONT	6229	P228	PERI	6295-CAM	P240	ZERTA	P9034	P152
FRONT	6230	P228	PERI	6294-PIR/6295-PIR	P206	ZETA	P9011	P166
FRONT	6229-800	P228	PERI	6290	P234	ZIPO	6243	P224
GEMINI	1891S	P90	PERI	6293	P236	ZOE	2401S	P116