



acca Group[®]

LIGHTING APOSTOLIDIS

THE PROFESSIONAL
LIGHTING COLLECTION

2019



LIGHTING APOSTOLIDIS

Νέες εγκαταστάσεις 3000 τ.μ.
στην περιοχή του Πειραιά
για την καλύτερη εξυπηρέτησή σας



ΠΑΛΑΜΗΔΙΟΥ 15 • 18545 ΠΕΙΡΑΙΑΣ

Παραμένουν προς εξυπηρέτησή σας και οι εγκαταστάσεις
στην Λοχαγού Σταθιά 1, Άγιος Ιωάννης Ρέντης

www.acalight.gr

acca[®] LIGHTING APOSTOLIDIS

PROFESSIONAL LIGHTING 2019

Since 1965...



...still developing.

www.acalight.gr

ACA LIGHTING APOSTOLIDIS GROUP

(ΕΛΛΗΝΙΚΑ)

Ο όμιλος εταιρειών ΑΠΟΣΤΟΛΙΔΗΣ "ACA" κατέχει ηγετική θέση στον κλάδο εμπορίας επαγγελματικού-αρχιτεκτονικού φωτισμού και ηλεκτρολογικού υλικού στην Ελλάδα αλλά και στην ευρύτερη περιοχή των Βαλκανίων και ανατολικών χωρών. Παράλληλα, δραστηριοποιείται στον κλάδο κατασκευής φωτιστικών σωμάτων και εμπορίας εσωτερικού φωτισμού και ενεργειακών λύσεων. Η "ACA" διαθέτει μακροχρόνια παράδοση, εμπειρία και τεχνογνωσία στον κλάδο. Ιδρύθηκε το 2001 ως μετεξέλιξη παλαιότερων εταιριών των ίδιων εταίρων, αρχής γενομένης το 1965 και εδραιώθηκε γρήγορα στην ελληνική αγορά. Εδρεύει στη πόλη των Σερρών σε συνολικές εγκαταστάσεις 8.880 τμ στεγασμένων και μετρά ενεργό πελατολόγιο άνω των 3.000 επιχειρήσεων. Τα τελευταία έτη επέκτεινε τις εγκαταστάσεις της στον Πειραιά με αποθήκες 3.600 τ.μ., στην Βουλγαρία με 1.300 τ.μ. και στην Τσεχία.

Βασικές αρχές του ομίλου από την ίδρυση της πρώτης του εταιρείας αποτελούν η ευελιξία, η συνέπεια και η ανάπτυξη μακροχρόνιων δεσμών με τους πελάτες και τους προμηθευτές της. Η μεγάλη ποικιλία των προϊόντων μας αποδεικνύει την συνεχή αναζήτηση και ανανέωση αυτών για να μπορούμε να καλύπτουμε οποιαδήποτε νέα ανάγκη προκύπτει στην αγορά. Με εστίαση στην υψηλή ποιότητα των προϊόντων και στην άριστη εξυπηρέτηση των πελατών και διαθέτοντας ένα εκτεταμένο, πλήρως οργανωμένο δίκτυο αποθήκευσης και διάθεσης των προϊόντων, η "ACA" προσφέρει στον πιο απαιτητικό πελάτη τις πλέον ολοκληρωμένες λύσεις.

Η τήρηση των νομοθετικών απαιτήσεων και η προστασία του Περιβάλλοντος αποτελούν μέρος της Επιχειρηματικής Στρατηγικής της "ACA". Η εταιρεία συμμετέχει ενεργά στην Φωτοκύκλωση Α.Ε συνεισφέροντας στην Εθνική ανακύκλωση και βοηθώντας στη μείωση της περιβαλλοντολογικής καταστροφής.

Η εταιρεία έχει αναπτύξει και εφαρμόζει :

- Σύστημα Διαχείρισης Ποιότητας σύμφωνα με το Πρότυπο ISO 9001:2015
- Σύστημα Διαχείρισης της Υγιεινής και Ασφάλειας στην Εργασία σύμφωνα με το Πρότυπο ΕΛΟΤ 1801:2008/OHSAS 18001:2007
- Σύστημα Περιβαλλοντικής Διαχείρισης σύμφωνα με το Πρότυπο ΕΛΟΤ EN ISO 14001:2004

(ENGLISH)

The group companies APOSTOLIDIS "ACA" is leader in professional - architectural lighting market and electrical equipment in Greece and the wider Balkan and eastern countries. In parallel, active in the lighting fixtures manufacturing and in trading sector of interior lighting and energy solutions. "ACA" has a long tradition, experience and expertise in the industry. Founded in 2001 as an evolution of previous companies of the same partners, starting in 1965 and quickly established itself in the Greek market. Headquartered in the city of Serres in overall facilities 8.880 sqm roofed and counts clientele of more than 3,000 companies. In recent years "ACA" has expanded its facilities in Piraeus with 3.600 sqm warehouses, in Bulgaria with 1.300 sqm and in the Czech Republic.

Fundamentals of the group since the foundation of the first company are flexibility, reliability and the development of long-term relationships with customers and suppliers. "ACA" in cooperation with major manufacturers of luminaires, offers innovative and modern products in the best quality - price. The wide range of our products proves the constant search and refresh to be able to cover any new need arising in the market. Focus on high quality products and excellent customer services and offering an extensive, well organized network storage and disposal of products, "ACA" offers to the most demanding customer the most complete solutions.

Compliance with the legislative requirements and the protection of the environment are part of the Business Strategy of "ACA". "ACA" is actively involved in Fotokiklosi SA contributing to national recycling and helping to reduce environmental destruction.

The company has developed and implemented:

- Quality Management System according to Standard ISO 9001: 2015
- Management of Health and Safety at Work System according to Standard EN 1801: 2008 / OHSAS 18001: 2007
- Environmental Management System according to Standard EN ISO 14001: 2004

ACA LIGHTING APOSTOLIDIS GROUP

(CZECH)

Skupina APOSTOLIDIS "ACA" zaujímá vedoucí postavení na trhu profesionálního – architektonického osvětlení a elektro materiálu nejen na území Řecké republiky, ale i v širší oblasti Balkánského poloostrova a východní Evropy.

Současně se zabývá výrobou svítidel a obchodem s interiérovým osvětlením a návrhy energetického řešení.

Společnost "ACA" v daném oboru disponuje dlouhodobou tradicí, zkušenostmi a odbornými znalostmi. Byla založena v roce 2001 jako pokračování dřívějších společností stejných společníků založených v roce 1965, které se rychle etablovaly na řeckém trhu. Své sídlo má ve městě Serres, kde se nachází halový objekt společnosti o celkové rozloze 8.800 m² s klientelou více než 3000 firem. V posledních letech "ACA" rozšířila své pobočky v Pireus o 3.600 m², v Bulharsku o 1.300 m². a v České republice.

Již od založení první společnosti jsou základní filosofií skupiny flexibilita, spolehlivost a rozvoj dlouhodobých vztahů s klienty a dodavateli. Široká škála našich výrobků dokládá naše neustálé úsilí o jejich modernizaci, aby bylo možné pokrýt nové potřeby trhu. Se zaměřením na vysoce kvalitní produkty a na vynikající služby našim zákazníkům, disponující rozsáhlou a dobře zorganizovanou sítí skladových prostor a distribuční sítí, řada "ACA" nabízí i těm nejnáročnějším zákazníkům komplexní řešení.

Dodržování legislativních požadavků a ochrana životního prostředí jsou součástí obchodní strategie společnosti "ACA".

Společnost má aktivní účast ve Fotokyklosi A.E., čímž přispívá k recyklaci na národní úrovni a napomáhá snižování rizika ničení životního prostředí.

Společnost vyvinula a implementovala:

- Systém managementu jakosti podle normy ISO 9001:2015
- Systém řízení hygieny a bezpečnosti práce podle normy ELOT 1801:2008/OHSAS 18001:2007
- Systém environmentálního managementu podle normy ELOT EN ISO 14001:2004

(BULGARIAN)

Дружествата от Групата Апостолидис "ACA" са лидер в професионалното архитектурно осветление и електрическо оборудване в Гърция и в по-големите балкански и източноевропейски страни. Успоредно с това, фирмата е активна в производството на осветителни тела и в търговията в сектор „Вътрешно осветление и енергийни решения“. "ACA" има дълга традиция, опит и експертиза в индустрията. Основана е през 2001 г. като продължение на предишните фирми на едни и същи партньори, започнали през 1965 г., и се утвърждава бързо на гръцкия пазар. Базирана е в град Серес, на обща площ от 8.880 кв м и има повече от 3000 фирми клиенти. През последните години "ACA" разшири своята база в Пирея с 3.600 кв.м складови помещения, в България с 1.300 кв.м и в Чешката република.

В основата на създадената групата, от началото на първото дружество, са гъвкавост, надеждност и развитие на дългосрочни взаимоотношения с клиенти и доставчици. Широката гама от нашите продукти доказва постоянното търсене и обновяване, за да може да се покрие всяка нова нужда, произтичаща на пазара. С акцент върху висококачествени продукти и отлично обслужване на клиенти, добре организираната мрежа за съхранение и наличност на продуктите, "ACA" предлага на най-взискателните клиенти най-пълните решения.

Спазването на нормативните изисквания и опазването на околната среда са част от бизнес стратегията на "ACA". Компанията участва активно с принос към Националната политика за рециклиране Fotokyklosi SA и помага да се намали замърсяването на околната среда.

Компанията е разработила и прилага:

- Стандарт за управление на качеството в съответствие с ISO 9001: 2015
- Система за управление на здравето и безопасността при работа, съгласно стандарт ELOT 1801: 2008 / OHSAS 18001: 2007
- Стандарт за управление на околната среда в съответствие с БДС EN ISO 14001: 2004

5-10		ΦΩΤΙΣΤΙΚΑ ΠΛΑΤΕΙΩΝ PARK LUMINAIRES
11-14		ΦΩΤΙΣΤΙΚΑ ΟΔΙΚΟΥ - ΑΞΟΝΙΚΟΥ - ΣΗΡΑΓΓΩΝ STREET - AXIAL - TUNNEL LUMINAIRES
15-16		ΦΩΤΙΣΤΙΚΑ ΤΥΠΟΥ ΚΑΜΠΑΝΑΣ HIGH BAY LUMINAIRES
17-20		ΠΡΟΒΟΛΕΙΣ FLOOD LUMINAIRES
21-38		ΦΩΤΙΣΤΙΚΑ ΕΞΩΤΕΡΙΚΩΝ ΧΩΡΩΝ OUTDOOR LUMINAIRES
39-47		ΑΡΧΙΤΕΚΤΟΝΙΚΟΣ ΦΩΤΙΣΜΟΣ ΕΞΩΤΕΡΙΚΩΝ ΧΩΡΩΝ ARCHITECTURAL OUTDOOR LIGHTING
48-60		ΦΩΤΙΣΤΙΚΑ ΦΘΟΡΙΣΜΟΥ FLUORESCENT LUMINAIRES
61-78		ΦΩΤΙΣΤΙΚΑ ΕΣΩΤΕΡΙΚΩΝ ΧΩΡΩΝ INDOOR LUMINAIRES
79-86		ΦΩΤΙΣΤΙΚΑ ΑΡΧΙΤΕΚΤΟΝΙΚΟΥ ΦΩΤΙΣΜΟΥ ΕΣΩΤΕΡΙΚΩΝ ΧΩΡΩΝ INDOOR ARCHITECTURAL LIGHTING LUMINAIRES
87-96		ΚΟΝΣΟΛΕΣ ΕΣΩΤΕΡΙΚΩΝ ΧΩΡΩΝ INDOOR CONSOLES
97-101		ΠΡΟΒΟΛΕΙΣ ΕΣΩΤΕΡΙΚΩΝ ΧΩΡΩΝ INDOOR FLOOD LUMINAIRES
102-112		ΡΑΓΕΣ - ΦΩΤΙΣΤΙΚΑ ΡΑΓΑΣ TRACKS - TRACK LUMINAIRES
113-118		ΔΙΑΚΟΣΜΗΤΙΚΕΣ ΚΑΜΠΑΝΕΣ DECORATIVE HIGH BAYS
119		ΣΠΟΤ ΠΙΝΑΚΩΝ GALLERY WALL LUMINAIRE
120-121		ΦΩΤΙΣΤΙΚΑ ΟΠΤΙΚΩΝ ΙΝΩΝ FIBER OPTIC LUMINAIRES
122		ΑΝΕΜΙΣΤΗΡΕΣ FANS

*Ο παρών κατάλογος ισχύει από 01/02/2019, αναιρεί κάθε προηγούμενο όπως και ειδικές τιμές netto, φυλλάδια προσφορών κ.λ.π.
Στις αναγραφόμενες τιμές δεν συμπεριλαμβάνεται ο Φ.Π.Α. και ο Φ.Α.

*This catalogue is valid from 01/02/2019, negates all previous as special prices netto, offer brochures etc.
The prices do not include VAT and recycling tax.

Κεφαλές πλατειών / Top luminaires CITY TONE

IP65



8035I



8035II



8033



8021

*8035I

*8035II

*8033

*8021

- Χυτό αλουμίνιο / Die-casting aluminum.
- Πολυκαρβονικό κάλυμμα / PC cover.
- Περίσφιδα αλουμινίου / Built-in aluminum louvre.
- Ντουί / Lampholder E27.

ΓΚΡΙ
GREY

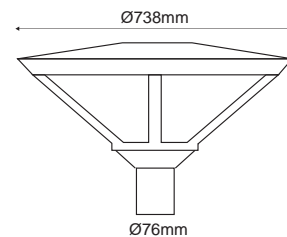

8035I
8035II

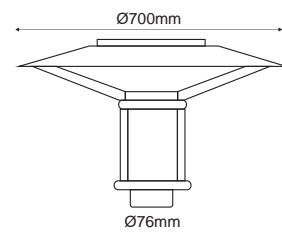

8033

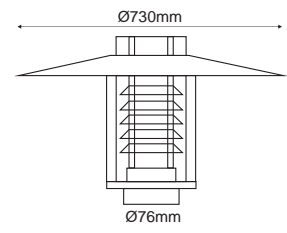

8021

Κεφαλές πλατειών / Top luminaires CITIZEN

IP65



S0022*



S0016

S0022E27 Κενό με E27 ντουί /
Empty with E27 lampholder

S0022E40 Κενό με E40 ντουί /
Empty with E40 lampholder

S0022RX7S Κενό με RX7S ντουί /
Empty with RX7S lampholder

***S0016** Με κάτοπτρο και E27 ντουί /
With reflector and E27 lampholder

- Χυτό αλουμίνιο / Die-casting aluminum.
- Πολυκαρβονικό κάλυμμα / PC cover.
- Ντουί / Lampholder E27, E40, RX7s.

ΓΚΡΙ
GREY

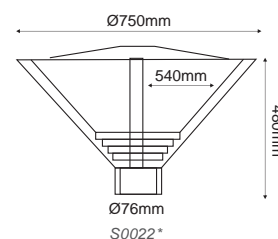

S0022*

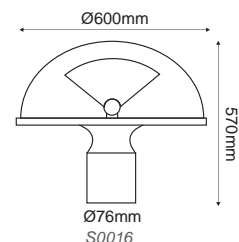

S0016

Στις τιμές δεν συμπεριλαμβάνεται σύστημα έναυσης / Prices do not include a gear box

*Υπό κατάργηση / Under abolition

Κεφαλές πλατειών / Top luminaires *EVOLUTION*

IP65



BST2160A
BST2160AN



BST2160C

BST2160AN Νέου τύπου / New type

BST2160A

BST2160C Με καπέλο / With shade

- Χυτό αλουμίνιο / Die-casting aluminum.
- Πολυκαρβονικό κάλυμμα / PC cover.
- Ειδική λειτουργία αφύγρανσης / Special dry function.
- Ντουί / Lampholder E27.

ΓΚΡΙ
GREY

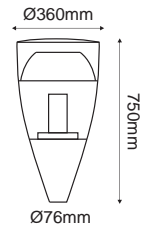

BST2160A*

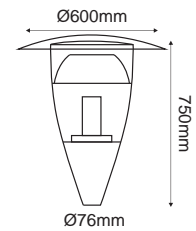

BST2160C

Κεφαλές πλατειών / Top luminaires *POLARMOD*

IP65



BST2170AR



BST2170A

BST2170AR Με ανταυγαστήρα
αντιθάμβωσης / With anti-glare reflector

BST2170A

***BST2590B**

- Χυτό αλουμίνιο / Die-casting aluminum.
- Πολυκαρβονικό κάλυμμα / PC cover.
- Ντουί / Lampholder E27.

ΓΚΡΙ
GREY

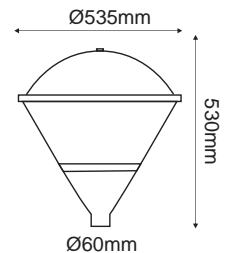

BST2170A*

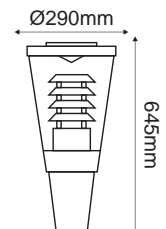

BST2590B



BST2590B

Κεφαλές πλατειών έμμεσου φωτισμού / Indirect top luminaires *HOSI*

IP65



8338V



8338I

***8338I** Κενό / Empty

***8338V** Κενό / Empty

- Χυτό αλουμίνιο / Die-casting aluminum.
- Ανακλαστήρας από ανοξείδωτο χάλυβα υψηλής απόδοσης / High efficiency reflector made by stainless steel.
- Ντουί / Lampholder E27.

ΓΚΡΙ
GREY

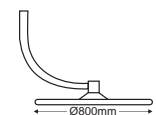

8338V

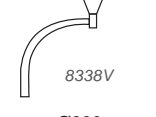

8338V

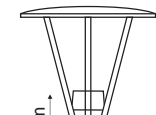

8338I

Στις τιμές δεν συμπεριλαμβάνεται σύστημα έναυσης / Prices do not include a gear box

*Υπό κατάργηση / Under abolition

Κεφαλές πλατειών / Top luminaires PHILIPPOS

IP54



AC.2160M
AC.2250M

AC.2160M HWL 160W E27 Κενό / Empty

AC.2250M HWL 250W E40 Κενό / Empty

- Χυτό κράμα αλουμινίου / Die-casting aluminum.
- Ακρυλικός γαλακτερός διαχύτης / Acrylic opal diffuser.
- Ντουί / Lampholder E27, E40.

ΓΚΡΙ
GREY

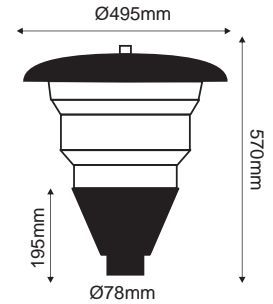

AC.2160M
AC.2250M

Κεφαλές πλατειών / Top luminaires WIDY

IP65



***S0050** Κενό / Empty

- Χυτό αλουμίνιο / Die-casting aluminum.
- Πολυκαρβονικό κάλυμμα / PC cover.
- Ντουί / Lampholder E27.

ΓΚΡΙ
GREY

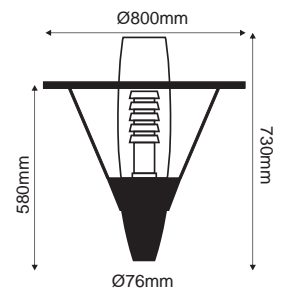

Κεφαλές πλατειών / Top luminaires POLYC

IP65



***8502** Κενό / Empty

- Χυτό αλουμίνιο / Die-casting aluminum.
- Πολυκαρβονικό πρισματικό κάλυμμα / PC prismatic cover.
- Ντουί / Lampholder E27.

ΓΚΡΙ
GREY

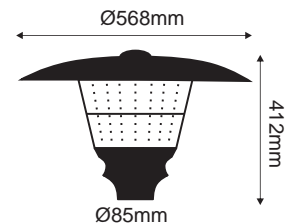

Φωτιστικά πλατειών / Sidewalk luminaires POLYC

IP55



***HLSGMU019** Κενό / Empty

- Αλουμίνιο / Aluminum.
- Ανοδιωμένος κυψελοειδής καθρέπτης αλουμινίου / Anodized honeycomb aluminum reflector.
- Ντουί / Lampholder E40.

ΓΚΡΙ
GREY

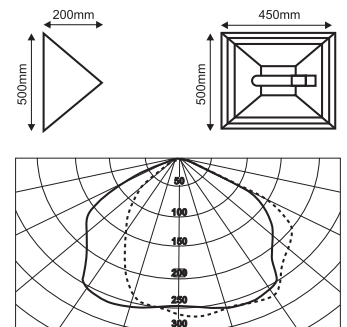

Φανάρια πλατειών / Lantern luminaires PAGODA

IP65



S0019

S0019 Φανάρι μεγάλο / Big lantern E40

S0018 Φανάρι μικρό / Small lantern E27

- Αλουμίνιο / Aluminum.
- Πολυκαρβονικό κάλυμμα / PC cover.
- Ντουί / Lampholder E27.

ΓΚΡΙ
GREY

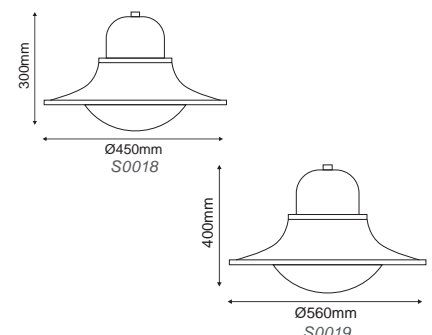

Στις τιμές δεν συμπεριλαμβάνεται σύστημα έναυσης / Prices do not include a gear box

*Υπό κατάργηση / Under abolition

Παραδοσιακά φανάρια πλατειών / Traditional lantern luminaires COMO

IP54/5



HI8001G



HI8002G



HI8003G



HI8111



HI8112



HI501261



HI501133



HI501201



HI50030

230V | E27 max. 100W

HI8001G 4 πλευρών ανθρακί / 4 sides anthracite

HI8002G 4 πλευρών ανθρακί / 4 sides anthracite

HI8003G 4 πλευρών ανθρακί / 4 sides anthracite

HI8111 4 πλευρών γκρι / 4 sides grey

HI8112 4 πλευρών γκρι / 4 sides grey

HI501261 6 πλευρών μαύρο / 6 sides black

HI501133 6 πλευρών γκρι / 6 sides grey

HI501201 4 πλευρών μαύρο / 4 sides black

HI50030 4 πλευρών μαύρο / 4 sides black

- Χυτό κράμα αλουμινίου / Die-casting aluminum.
- Πρισματικό γυαλί / Prismatic glass.
- (HI8001G, HI8002G, HI8003G) Διαφανές γυαλί / Transparent glass.
- Ντουι / Lampholder E27.

ΜΑΥΡΟ
BLACK



ΓΚΡΙ
GREY



ΑΝΘΡΑΚΙ
ANTHRACITE

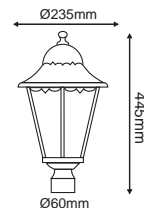

HI8001G

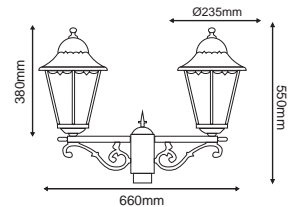

HI8002G

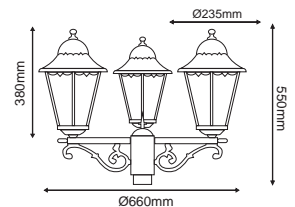

HI8003G

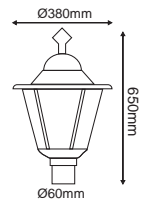

HI8111

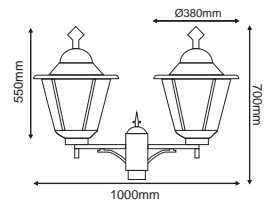

HI8112

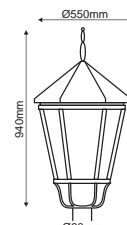

HI501261

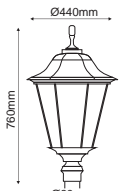

HI501133



HI501201

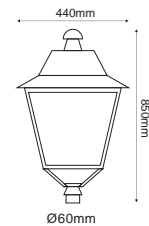

HI50030



Στις τιμές δεν συμπεριλαμβάνεται σύστημα έναυσης / Prices do not include a gear box

*Υπό κατάργηση / Under abolition

Φωτιστικά πλατειών - πεζοδρόμων / Lighting columns for sidewalks SININ IP65



- *8003 4m Ø110mm → Ø89mm
- *8328II 3m Ø114mm → Ø108mm
- *8430 4m Ø140mm → Ø76mm
- F601142M 2m Ø114mm → Ø60mm
- F601143M 3m Ø114mm → Ø60mm
- F601144M 4m Ø114mm → Ø60mm
- F761403M 3m Ø140mm → Ø76mm
- F761404M 4m Ø140mm → Ø76mm
- F891404M 4m Ø140mm → Ø89mm
- F891405M 5m Ø140mm → Ø89mm
- SP60 Συστολή Ø76mm → Ø60mm
- SP89 Συστολή Ø89mm → Ø76mm
- F76TAP Τάπα για / Tap for Ø76mm

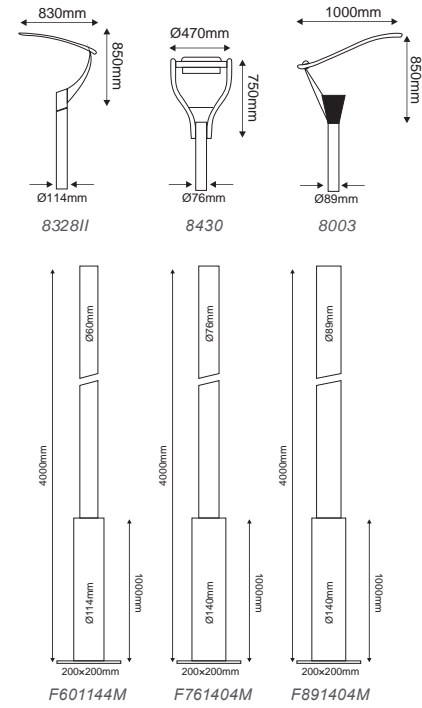

- Ιστός από χάλυβα γαλβανισμένος εν θερμώ / Steel hot dip galvanized pole.
- Φινίρισμα σκόνης πολυεστέρα για αντοχή στη διάβρωση / Corrosion resistant polyester powder coat finish.
- Ανοιγόμενη θυρίδα ελέγχου (εκτός 8328II) / Tailgate control (except 8328II).
- Ντουί E27 / Lampholder E27.



47000 Αγκύριο / Anchor M18

Ακροκιβώτια κολώνας / Columns terminal cases



- AMM3 Κενό πλαστικό κιβώτιο για 2NL / Empty plastic case for 2NL
- AC.41MKK1A Χυτό κιβώτιο 1 ασφάλεια / Casting case 1 circuit breaker
- AC.41MKK2 Χυτό κιβώτιο 2 ασφάλειες / Casting case 2 circuit breakers

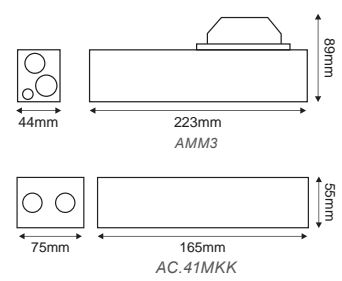

Παραδοσιακοι ιστοι αλουμινίου / Traditional aluminum poles HERMES



- AC.4100AB 4,1m Ø101mm → Ø60mm
- HIE0073 3m Ø260mm → Ø60mm
- HI234060 3,4m Ø60mm
- HIEC002 Διακοσμητική κορυφή / Decorative top Ø60mm

- Ιστός αλουμινίου γαλβανισμένος εν θερμώ / Aluminum hot dip galvanized pole.



Στις τιμές δεν συμπεριλαμβάνεται σύστημα έναυσης / Prices do not include a gear box
 *Υπό κατάργηση / Under abolition
 www.acalight.gr

Φωτιστικά πλατειών - πεζοδρόμων / Lighting columns for sidewalks

IP65



*8318 E27 & G13 1200mm 36W

*8001 E27 & G13 1200mm 36W

*8087 E27 - G13 1200mm 36W

- Ιστός από χάλυβα γαλβανισμένος εν θερμώ / Steel hot dip galvanized pole.
- Φινίρισμα σκόνης πολυεστέρα για αντοχή στη διάβρωση / Corrosion resistant polyester powder coat finish.
- Ντουί / Lampholder E27 & G13.

ΓΚΡΙ
GREY

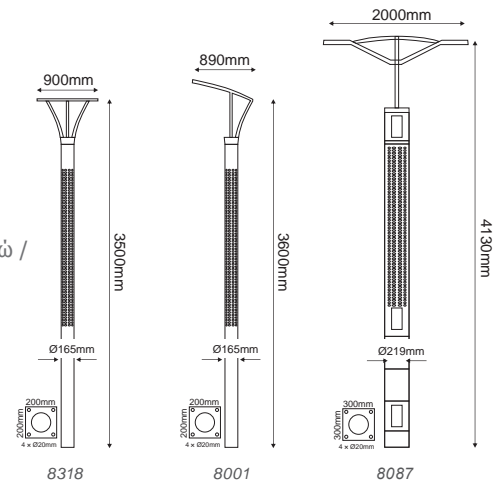

*8202 G13 1500mm 2x58W

*8080 G13 1500mm 2x58W

- Ιστός από χάλυβα γαλβανισμένος εν θερμώ / Steel hot dip galvanized pole.
- Φινίρισμα σκόνης πολυεστέρα για αντοχή στη διάβρωση / Corrosion resistant polyester powder coat finish.
- Πολυκαρβονικό κάλυμμα ανθεκτικό σε UV ακτινοβολία \ PC diffuser UV-resistant.
- Ντουί / Lampholder G13.

ΓΚΡΙ
GREY

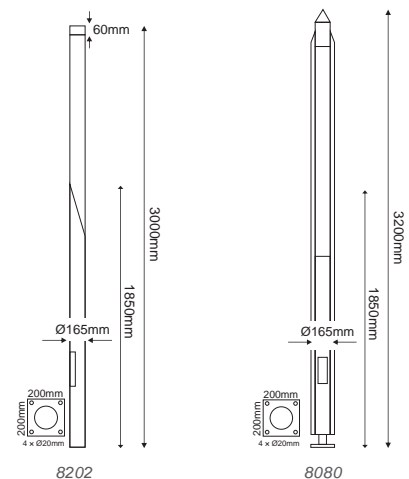

*8004 E27

*8416 E27

*8338II E27

- Γαλβανισμένος εν θερμώ ιστός / Hot dip galvanized pole.
- Φινίρισμα σκόνης πολυεστέρα για αντοχή στη διάβρωση/ Corrosion resistant polyester powder coat finish.
- Ντουί / Lampholder E27.

ΓΚΡΙ / GREY

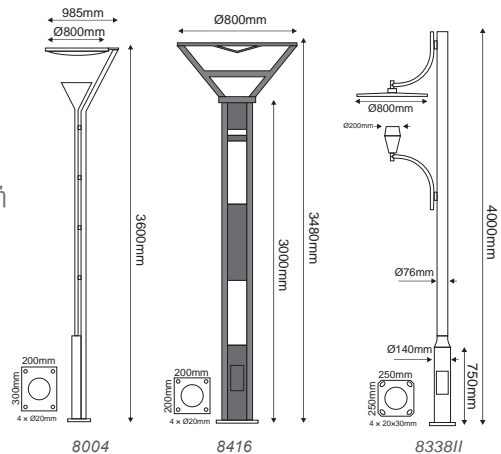

Στις τιμές δεν συμπεριλαμβάνεται σύστημα έναυσης / Prices do not include a gear box

*Υπό κατάργηση / Under abolition

Φωτιστικά οδικού / Street luminaires **OLYMPUS**



Χώρος λαμπήρα / Bulb area - IP54
Χώρος οργάνων / Electrical unit - IP23

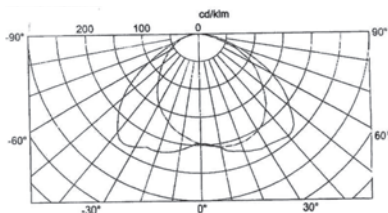

Νατρίου / High pressure sodium / HQI

AC.170NP SON-E 70W E27 Μικρό / Small

AC.1150NP SON-E 150W E40 Μεγάλο / Big

AC.1250NP SON-E 250W E40 Μεγάλο / Big

AC.1160M Κενό / Empty E27 Μικρό / Small

AC.1250M Κενό / Empty E40 Μεγάλο / Big

AC.4PMI Πλαστικό κάλυμμα για μικρό φωτιστικό / Plastic cover for small luminaire

AC.4PME Πλαστικό κάλυμμα για μεγάλο φωτιστικό / Plastic cover for big luminaire

- Χυτό κράμα αλουμινίου / Die casting aluminum.
- Ακρυλικό κάλυμμα / Acrylic cover.
- Καθρέπτης Αλουμινίου υψηλής καθαρότητας / High purity aluminum reflector.
- Ντουί / Lampholder E27, E40, G24.

Για βραχίονα / For bracket **Ø42**

Μικρό φωτιστικό / Small luminaire

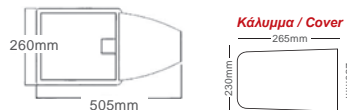
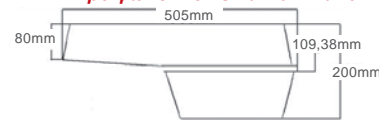

Μεγάλο φωτιστικό / Big luminaire

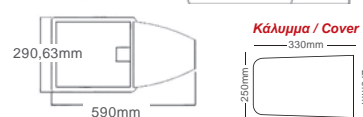
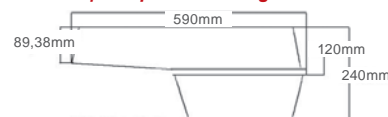

Υπάρχει δυνατότητα τοποθέτησης λαμπήρα οικονομίας E27 έως 60W ή LED
It is possible to install max. 60W E27 CFL or LED lamp

Φωτιστικά οδικού / Street luminaires **PEGASUS**



Χώρος λαμπήρα / Bulb area - IP65
Χώρος οργάνων / Electrical unit - IP23

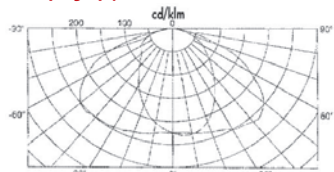

Νατρίου / High pressure sodium / HQI

***AC.18405NP** SON-E 250W

***AC.18401NP** SON-E 400W

***AC.18401HP** HQI 400W

***AC.18401M** HWL 500W Κενό / Empty

- Χυτό κράμα αλουμινίου / Die casting aluminum.
- Πολυκαρβονικό κάλυμμα / PC cover.
- Καθρέπτης Αλουμινίου υψηλής καθαρότητας / High purity aluminum reflector.
- Ντουί / Lampholder E40.

Για βραχίονα / For bracket **Ø48-Ø60**

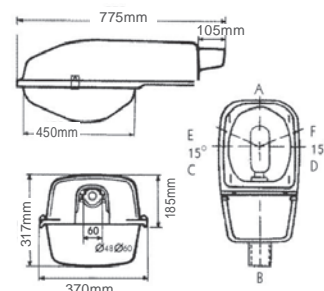

Υπάρχει δυνατότητα τοποθέτησης λαμπήρα οικονομίας E40 έως 150W ή LED
It is possible to install max. 150W E40 CFL or LED lamp

Φωτιστικά οδικού / Street luminaires **ZEUS**

IP65

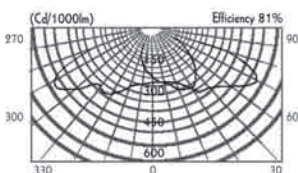

Νατρίου / High pressure sodium / HQI

AC.ISRN70P SON-T 70W

AC.ISRLE27MF HWL 160W Κενό / Empty

- Χυτό κράμα αλουμινίου / Die casting aluminum.
- Πυρίμαχο καμπύλο γυαλί / Fire resistant curved glass.
- Φωτεινή εκπομπή / Light emission CUT-OFF.
- Ντουί / Lampholder E27.

Για βραχίονα / For bracket **Ø42**

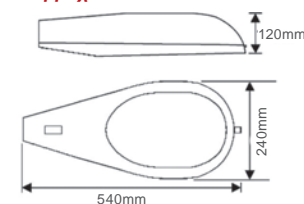

ΓΚΡΙ
GREY



Σε όλα τα φωτιστικά σώματα με λαμπήρες εκκένωσης, υπάρχει η δυνατότητα συστήματος βαθμιαίου dimming /
In all luminaires with discharge lamps, there is the possibility of step dimming system

Φωτιστικά οδικού / Street luminaires ZEUS

IP65



Νατρίου / High pressure sodium / HQI

AC.ISRN150P SON-T 150W

AC.ISRN250P SON-T 250W

AC.ISRN400P SON-T 400W

AC.ISRLE40MF Κενό / Empty

Για βραχίονα / For bracket Ø42-Ø60

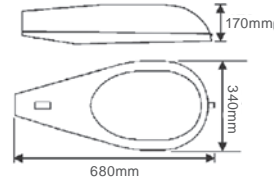

Δέχεται μόνο λάμπα σωληνωτή / Only for tubular lamp

- Χυτό κράμα αλουμινίου / Die casting aluminum.
- Πυρίμαχο καμπύλο γυαλί / Fire resistant curved glass.
- Καθρέπτης Αλουμινίου υψηλής καθαρότητας / High purity aluminum reflector.
- Φωτεινή εκπομπή / Light emission CUT-OFF.
- Ντουί / Lampholder E40.

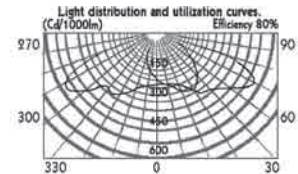

Φωτιστικά οδικού / Street luminaires FYZD

IP65



Με απασφάλιση / With disconnecting switch

Νατρίου / High pressure sodium / HQI

FYZD920S150N 150W

FYZD920S250N 250W

FYZD920S400N 400W

Metal halide / HQI

FYZD920S150H 150W

FYZD920S250H 250W

FYZD920S400H 400W

Χωρίς απασφάλιση / Without disconnecting switch

Νατρίου / High pressure sodium / HQI

FYZD920150N 150W

FYZD920250N 250W

FYZD920400N 400W

Metal halide / HQI

FYZD920150H 150W

FYZD920250H 250W

FYZD920400H 400W

Κενό χωρίς πυκνωτή / Empty without capacitor

FYZD920S Κενό / Empty

Κενό χωρίς πυκνωτή / Empty without capacitor

FYZD920 Κενό / Empty



- Χυτό κράμα αλουμινίου / Die casting aluminum.
- Πυρίμαχο κυρτό γυαλί / Fire resistant convex glass.
- Καθρέπτης Αλουμινίου υψηλής καθαρότητας / High purity aluminum reflector.
- Φωτεινή εκπομπή / Light emission CUT-OFF.
- Βραχίονας στήριξης για ασφαλή συντήρηση / Arm support for safe maintenance.
- Ρυθμιζόμενη γωνία / Adjustable angle 0-90°.

Για βραχίονα / For bracket Ø42-Ø60

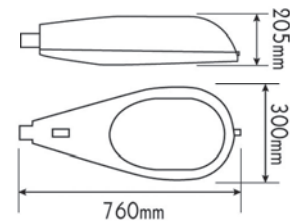

Φωτιστικά σηράγγων / Tunnel luminaires

IP65



YZDH702

YZDH702 Κενό / Empty

- Χυτό κράμα αλουμινίου / Die casting aluminum.
- Πυρίμαχο γυαλί / Fire resistant glass.
- Ντουί / Lampholder E40.

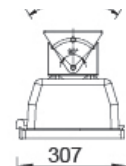
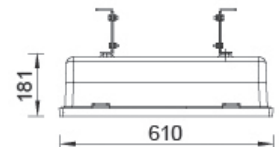

Σε όλα τα φωτιστικά σώματα με λαμπτήρες εκκένωσης, υπάρχει η δυνατότητα συστήματος βαθμιαίου dimming / In all luminaires with discharge lamps, there is the possibility of step dimming system

Φωτιστικά οδικού / Street luminaires

IP65



F862A

***F862A** Κενό λευκό / Empty white

- Πρεσαριστό φύλλο αλουμινίου / Pressing aluminum sheet.
- Ανοδιωμένος καθρέπτης αλουμινίου / High purity anodized aluminum reflector.
- Πυρίμαχο επίπεδο γυαλί / Fire resistant flat glass.
- Ντουί / Lampholder E27.
- Δέχεται σύστημα έναυσης / Can fit gear box 70-250W HQI/Na.

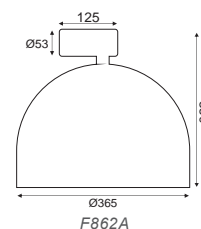

Για βραχίονα / For bracket Ø42 - Ø53



FYD863

FYD863 Κενό γκρι / Empty grey

- Χυτό κράμα αλουμινίου / Die casting aluminum.
- Πυρίμαχο κυρτό γυαλί / Fire resistant curved glass.
- Ντουί / Lampholder E40.

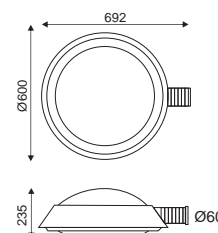

Για βραχίονα / For bracket Ø48 - Ø60

Φωτιστικά αξονικού / Axial luminaires BYLOR

IP54



Νατρίου / High pressure sodium / HQI

AC.170NAP SON-E 70W E27

AC.1150NAP SON-E 150W E40

AC.1250NAP SON-E 250W E40

***AC.1160MA HWL 160W E27 κενό / Empty**

***AC.1250MA HWL 250W E40 κενό / Empty**

- Ανοδιωμένο - στιλπνωμένο αλουμίνιο / Anodised - polish aluminum.
- Ακρυλικό κάλυμμα / Acrylic cover.
- Ντουί / Lampholder E27, E40.



Φωτιστικά οδικού / Street luminaires LION

IP65



AC.1273

AC.1273 Κενό / Empty

- Πρεσαριστό φύλλο αλουμινίου / Pressing aluminum sheet.
- Πολυκαρβονικό κάλυμμα / PC cover.
- Πολυκαρβονικά κλιπ / PC clips.
- Ντουί / Lampholder E27.

Για βραχίονα / For bracket Ø42

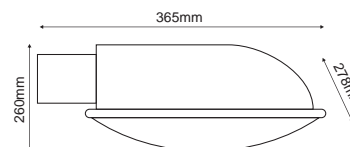

Υπάρχει δυνατότητα τοποθέτησης λαμπτήρα οικονομίας E27 ή LED
It is possible to install E27 CFL or LED lamp

*Υπό κατάργηση / Under abolition

www.acalight.gr

Φωτιστικά κολώνας / Column luminaires IRA

IP23



AC.1124

AC.1124 IRA ολοκληρωμένο φωτιστικό / Complete luminaire

AC.11241 Ανταυγαστήρας χωρίς ντουί / Reflector without lampholder

DEL0913 Βραχίονας / Bracket

- Καθρέπτης αλουμινίου / Aluminum reflector.
- Βραχίονας 1/2" σιδήρου / Iron bracket 1/2".



Συνδυάστε με λαμπτήρα LED υψηλής ισχύος
Combine with high power LED lamp

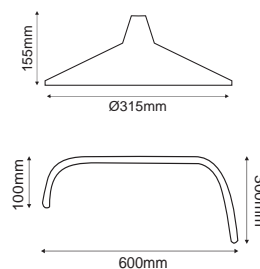

Φωτιστικά κολώνας / Column luminaires IRA2

IP23



AC.11251

AC.11251 IRA2 ολοκληρωμένο φωτιστικό / Complete luminaire

AC.11252 Ανταυγαστήρας χωρίς ντουί / Reflector without lampholder

098SO075 Βραχίονας / Bracket

- Χυτό κράμα αλουμινίου / Die-casting aluminum.
- Ηλεκτροστατική λευκή-πράσινη βαφή / White - green powder coating.
- Βραχίονας 3/4" σιδήρου με αντήρριο / Iron bracket 3/4" with truss.

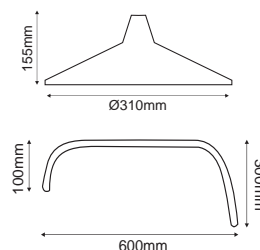

Προβολέας τοίχου - δαπέδου / Wall - floor flood light RETA

IP65



GR020BL

GR020L

GR026L



E27 max. 24W

GR020L Προβολέας Τοίχου / Wall flood luminaire Ø25

GR026L Προβολέας Τοίχου / Wall flood luminaire Ø31

GR020BL Προβολέας με μπράτσο / Wall flood luminaire with arm Ø25

- Χυτό κράμα αλουμινίου / Die-casting aluminum.
- Ηλεκτροστατική βαφή / Powder coating.
- Ανοξείδωτα κλιπ / Stainless clips.
- Πυρίμαχο επίπεδο γυαλί - φλάντζα στεγανοποίησης / Fire resistant flat glass - waterproof flange.
- Καθρέπτης ανοδιωμένου αλουμινίου / Anodised aluminum reflector.

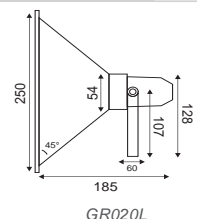

GR020L

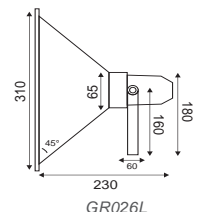

GR026L

Βραχίονες απο γαλβανισμένη σιδεροσωλήνα / Galvanized steel brackets

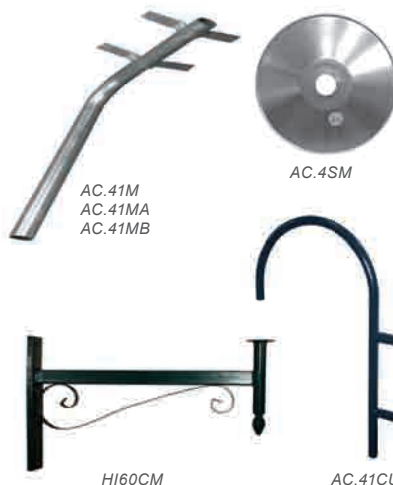

AC.41M
AC.41MA
AC.41MB

AC.4SM

HI60CM

AC.41CUR

AC.41M Ø42 1μέτρου / 1meter

AC.41MA Ø48 1μέτρου / 1meter

AC.41MB Ø60 1μέτρου / 1meter

HI60CM Βραχίονας / Bracket 60cm

AC.41CUR Ø40 Βραχίονας καμπύλος 2μέτρων για / Curved bracket 2meters for S0019

AC.4SM Σκιάδα αλουμινίου / Aluminum reflector Ø26

Ακτίνα καμπυλότητας / Radius of curvature : 200mm
Οριζόντια προβολή / Horizontal view : 0,65cm
Γαλβανιζέ κολάρα / Galvanized collars: 30 x 3mm

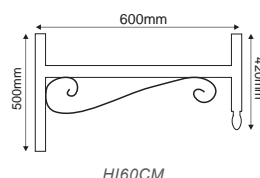
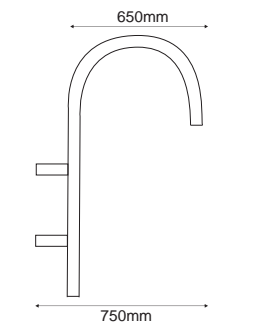

HI60CM



Υπάρχει η δυνατότητα ειδικών κατασκευών για όλους τους βραχίονες
There is the possibility of special structures for all arms

Φωτιστικά τύπου καμπάνας / High-bay luminaires ARTEMIS



Ø38

AC.3160MB Κενή / Empty E27 Ø38

AC.3160M Κενή / Empty E27 Ø46

AC.3250M Κενή / Empty E40 Ø46



Ø46

AC.4KALA7 Ακρυλικό κάλυμμα / Acrylic cover Ø46

AC.4121GL Γυαλί καμπάνας / High bay glass Ø46

- Καθρέπτης πρεσαριστός αλουμινίου / Pressing aluminium reflector.
- Προαιρετικά ακρυλικό κάλυμμα ή γυαλί / Optional acrylic cover or glass.
- Ντουί / Lampholder E27, E40.

- Χώρος οργάνων / Electrical unit - IP23
- Χώρος λαμπτήρα με AC.4KALA7 ή AC.4121GL / Bulb area with AC.4KALA7 or AC.4121GL - IP54
- Χώρος λαμπτήρα χωρίς AC.4KALA7 ή AC.4121GL / Bulb area without AC.4KALA7 or AC.4121GL - IP23



AC.4KALA7



AC.4121GL

ΓΚΡΙ
GREY

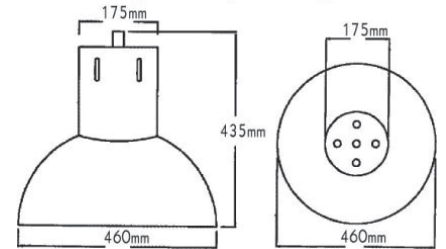
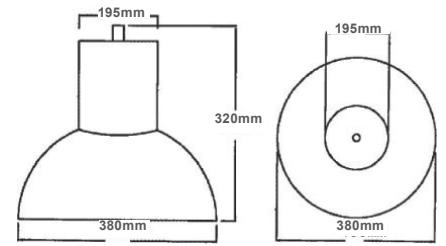

Ο κωδικός AC.3160MB δεν δέχεται πλαστικό κάλυμμα ή γυαλί
AC.3160MB does not accept plastic cover or glass



Υπάρχει δυνατότητα τοποθέτησης λαμπτήρα οικονομίας ή LED
It is possible to install CFL or LED lamp

Φωτιστικά τύπου καμπάνας / High-bay luminaires AELLO



*AC.3FYGC122 Κενή / Empty

*AC.4122GS Πλέγμα / Grid

- Χώρος λαμπτήρα / Bulb area - IP23
- Χώρος οργάνων / Electrical unit - IP45

Παίρνει μόνο πλέγμα - ΟΧΙ γυαλί
It only accepts grid - NO glass



AC.4122GS

- Καπέλο από χυτοπρεσαριστό κράμα αλουμινίου ηλεκτροστατικά βαμμένο / Pressing die-casting aluminum powder coated electric box.
- Ανταυγαστήρας από ανοδιωμένο φύλλο αλουμινίου / Anodised aluminum reflector.
- Ντουί / Lampholder E40.
- Προαιρετικά μεταλλικό πλέγμα / Optional metal grid.

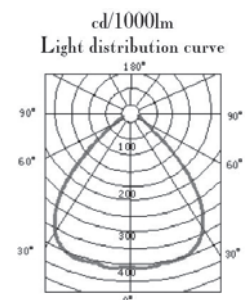
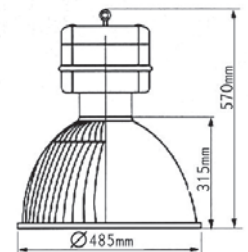

Υπάρχει δυνατότητα τοποθέτησης λαμπτήρα οικονομίας E40 ή LED
It is possible to install E40 CFL or LED lamp

*Υπό κατάργηση / Under abolition

Φωτιστικά τύπου καμπάνας / High-bay luminaires **KINYRA** IP65



***AC.3FYGC121** Κενή / Empty
AC.4121GSG Γυαλί με πλέγμα καμπάνας / High bay grid with glass
AC.4121GL Γυαλί καμπάνας / High bay glass

- Καπέλο από χυτοπρεσαριστό κράμα αλουμινίου / Pressing die-casting aluminum powder coated electric box.
- Ανταυγαστήρας από ανοδιωμένο φύλλο αλουμινίου / Anodised aluminum reflector.
- Ειδική λειτουργία αφύγρυνσης εξερισμού / Dry - ventilation special function.
- Ντουί / Lampholder E40.
- Προαιρετικά πυρίμαχο γυαλί ή πυρίμαχο γυαλί με πλέγμα / Optional fire resistant glass or fire resistant glass with grid.

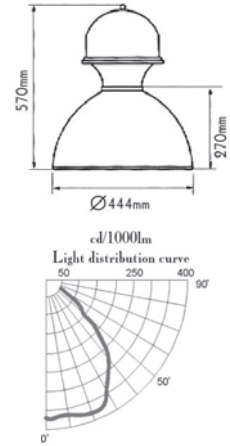

- Χώρος οργάνων / Electrical unit - IP65
- Χώρος λαμπτήρα με AC.4121GSG ή AC.4121GL / Bulb area with AC.4121GSG ή AC.4121GL - IP65
- Χώρος λαμπτήρα χωρίς AC.4121GSG ή AC.4121GL / Bulb area with out AC.4121GSG ή AC.4121GL - IP23



Υπάρχει δυνατότητα τοποθέτησης λαμπτήρα οικονομίας E40 ή LED
It is possible to install E40 CFL or LED lamp

Στις τιμές συμπεριλαμβάνεται και η αξία του πυκνωτή / The prices include the value of the capacitor

Φωτιστικά τύπου καμπάνας / High-bay luminaires **REA**



Χωρίς γυαλί / without glass
AC.31901 Ø47
Με γυαλί / with glass
AC.31901G Ø47

- Καπέλο ηλεκτροστατικά βαμμένο από χυτό αλουμίνιο / Powder coated steel electric box.
- Ανταυγαστήρας από ανοδιωμένο φύλλο αλουμινίου / Anodised aluminum reflector.
- Ντουί / Lampholder E40.
- Μεταλλικοί αποστάτες για ιδανικό εξερισμό / Metal spacers for optimum ventilation.

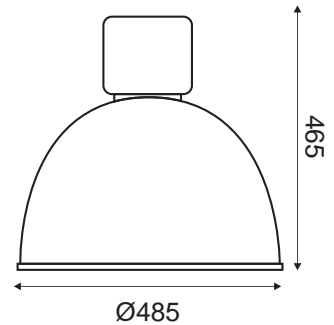

Υπάρχει δυνατότητα τοποθέτησης λαμπτήρα οικονομίας E40 ή LED
It is possible to install E40 CFL or LED lamp

Φωτιστικά τύπου καμπάνας / High-bay luminaires **MYRTIS**



AC.319RE Ø47

- Καπέλο ηλεκτροστατικά βαμμένο από χυτό αλουμίνιο / Powder coated aluminum electric box.
- Ανταυγαστήρας από κρυσταλιζέ πρισματικό κάλυμμα / Reflector of granulated prismatic cover.
- Ντουί / Lampholder E40.
- Διάτρητο μεταλλικό δαχτυλίδι - αποστάτης / Perforated metal ring - spacer.

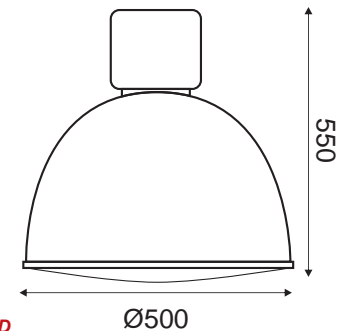

Υπάρχει δυνατότητα τοποθέτησης λαμπτήρα οικονομίας E40 ή LED
It is possible to install E40 CFL or LED lamp

Καπέλο για καμπάνα / Electric box for high-bay IP65



FYGC10 Καπέλο κενό / Empty electric box

- Καπέλο από χυτοπρεσαριστό κράμα αλουμινίου / Pressing die-casting aluminum powder coated electric box.

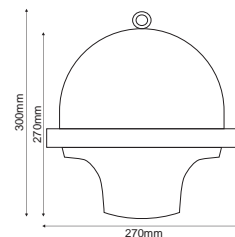

***Υπό κατάργηση / Under abolition**

Προβολέας θέρμανσης 1300W / Heating flood luminaire 1300W

IP65



AC.0450063 Με 2 αντιστάσεις άνθρακα /
With 2 carbon resistors

- Χυτό κράμα αλουμινίου / Die-casting aluminum.
- Πυρίμαχο γυαλί / Fire resistant glass.
- Ανοξείδωτα κλιπ / Stainless clip.
- Μεταλλικό πλέγμα προστασίας / Metal protection grid.
- Πυρίμαχο καλώδιο 2 μέτρων με φις / 2 meter fire resistant cable with adaptor.



Ιδανικό για χώρους εστίασης και καφετέριες / Ideal for for dining areas and cafes

Προτεινόμενο ύψος εγκατάστασης
Suggested installation height

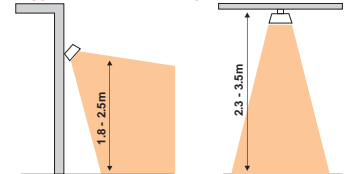

Προβολείς ιωδίνης / Halogen flood luminaires HALOS

IP54



ΛΕΥΚΟ
WHITE
WL

ΜΑΥΡΟ
BLACK
W

***AC.045005WL** Λευκός / White max.150W

***AC.045006WL** Λευκός / White max.500W

***AC.045007W** Λευκός / White max.1000W

***AC.045017W** Μαύρος / Black 1500W

***AC.045017WL** Λευκός / White 1500W

- Χυτό κράμα αλουμινίου / Die-casting aluminum.
- Πυρίμαχο γυαλί / Fire resistant glass.
- Κυψελοειδής ανταυγαστήρας αλουμινίου / Honeycomb aluminum reflector.
- Ντουί / Lampholder R7s.

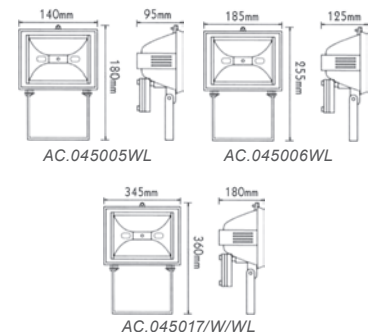

Προβολείς ιωδίνης με φωτοκύτταρο / Halogen flood luminaires with photocell HALOS2

IP54



ΓΚΡΙ
GREY

***AC.045005SG** max.150W

***AC.045006SG** max.500W

- Χυτό κράμα αλουμινίου / Die-casting aluminum.
- Πυρίμαχο γυαλί / Fire resistant glass.
- Κυψελοειδής ανταυγαστήρας αλουμινίου / Honeycomb aluminum reflector.
- Αισθητήρας κίνησης / Movement sensor.
- Ντουί / Lampholder R7s.

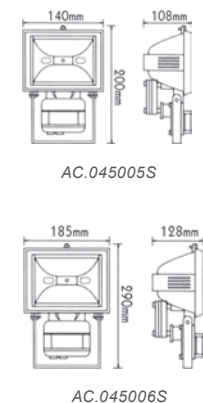

Προβολέας ιωδίνης / Halogen flood luminaires HALOS3

IP54



28076

ΜΑΥΡΟ
BLACK

***28076** max.150W

- Χυτό κράμα αλουμινίου / Die-casting aluminum.
- Πυρίμαχο γυαλί / Fire resistant glass.
- Κυψελοειδής ανταυγαστήρας αλουμινίου / Honeycomb aluminum reflector.
- Ντουί / Lampholder R7s.

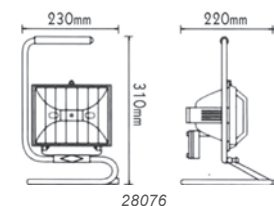

Προβολέας μεταλλικών αλογονιδίων / Metal halide flood luminaire 70-150W BIOS

IP65



ΛΕΥΚΟ
WHITE

ΜΑΥΡΟ
BLACK

ΓΚΡΙ
GREY

HQI-TS 70W

AC.045H70CW Λευκό / White

AC.045H70CB Μαύρο / Black

AC.045H70CG Γκρι / Grey

HQI-TS 150W

AC.045H150CW Λευκό / White

AC.045H150CB Μαύρο / Black

AC.045H150CG Γκρι / Grey

- Χυτό κράμα αλουμινίου / Die-casting aluminum.
- Πυρίμαχο γυαλί / Fire resistant glass.
- Κυψελοειδής ανοδιωμένος αντανακστήρας αλουμινίου / Honeycomb anodised aluminum reflector.
- Ασύμμετρη δέσμη φωτισμού / Asymmetrical light emission.
- Ντουί / Lampholder RX7s.

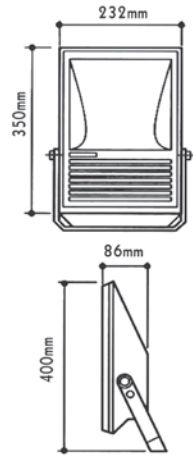

Προβολέας μεταλλικών αλογονιδίων / Metal halide flood luminaire 70-150W TEMPOR

IP65



R150SBN200

*R150SBN200 150W Ασύμμετρος / Asymmetric

*R150SBN200 Κενός / Empty

*R150SBN350 150W Συμμετρικός / Symmetric

*R150SBN350 Κενός / Empty

*R150SBN747 70W Συμμετρικός / Symmetric

*R150SBN747 Κενός / Empty

*R150SBN746 150W Συμμετρικός / Symmetric



R150SBN350

- Ενισχυμένο κράμα αλουμινίου / Enhanced die-casting aluminum.
- Πυρίμαχο γυαλί / Fire resistant glass.
- Κυψελοειδής ανοδιωμένος αντανακστήρας αλουμινίου / Honeycomb anodised aluminum reflector.
- Ντουί / Lampholder RX7s.

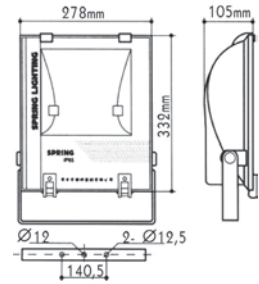

R150SBN200

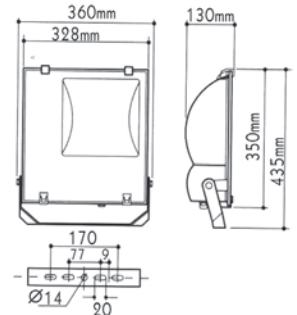

R150SBN350



R150SBN747

ΓΚΡΙ
GREY

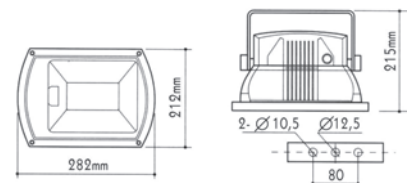

R150SBN747

Προβολέας μεταλλικών αλογονιδίων στενής δέσμης / Narrow beam metal halide flood luminaire 70-150W **IP65**



***AC.045SP05 70W / 150W**
***AC.045SP05 Κενός / Empty**

- Χυτό κράμα αλουμινίου / Die-casting aluminum
- Πυρίμαχο επίπεδο γυαλί / Fire resistant flat glass
- Ντουί / Lampholder G12

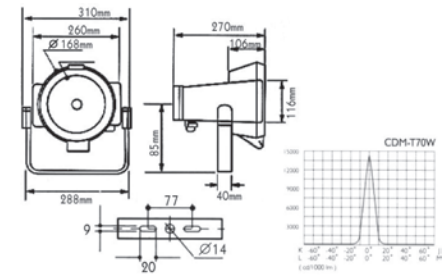

Προβολέας μεταλλικών αλογονιδίων / Metal halide flood luminaire 70-150W **TEMPOR 2** **IP65**



E400SBN202

Λαμπτήρα οικονομίας / CFL R7s max. 100W
***E400SBN202 400W Συμμετρικός / Symmetric**
***E400SBN202 Κενός / Empty**

Λαμπτήρα οικονομίας / CFL R7s max. 60W
***E400SBN350 400W Ασύμμετρος / Asymmetric**
***E400SBN350 Κενός / Empty**

- Χυτοπρεσαριστό κράμα αλουμινίου / Die-casting aluminum.
- Πυρίμαχο γυαλί / Fire resistant glass.
- Κυψελοειδής ανταυγαστήρας αλουμινίου / Honeycomb aluminum reflector.
- Ντουί / Lampholder R7s.

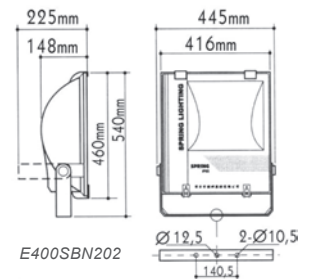

E400SBN350

ΓΚΡΙ
GREY

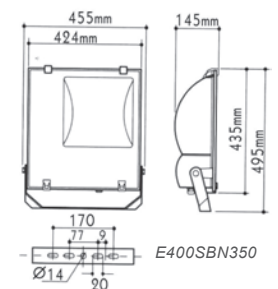

Κατόπιν ερωτήσεως Νατρίου / Sodium under demand

Προβολέας μεταλλικών αλογονιδίων / Metal halide flood luminaire 400W **IP65**



FYGT303II

***FYGT303II 400W Ασύμμετρος / Asymmetric**
***FYGT337I 400W Συγκεντρωτικής δέσμης / Spot beam**

- Χυτοπρεσαριστό κράμα αλουμινίου / Die-casting aluminum.
- Πυρίμαχο γυαλί / Fire resistant glass.
- Ντουί / Lampholder E40.

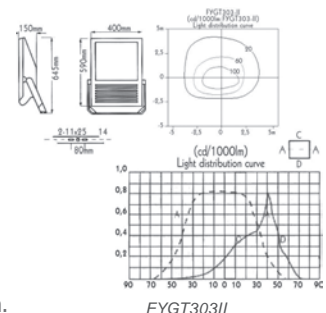

FYGT337I

ΓΚΡΙ
GREY

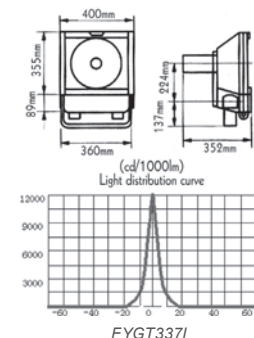

Κατόπιν ερωτήσεως Νατρίου / Sodium under demand

***Υπό κατάργηση / Under abolition**

Προβολέας μεταλλικών αλογονιδίων / Metal halide flood luminaire 250-400W MILE

IP65



**Δυνατότητα τοποθέτησης
λαμπτήρα οικονομίας 100W ή LED /
Ability to place CFL lamp 100W
or LED lamp**



- Χυτό κράμα αλουμινίου / Die-casting aluminum.
- Πυρίμαχο γυαλί / Fire resistant glass.
- Κυψελοειδής ανταυγαστήρας αλουμινίου / Honeycomb aluminum reflector.
- Ντουί / Lampholder E27, E40.

HQI 250W

AC.045250CW Λευκός / White

AC.045250CB Μαύρος / Black

AC.045250CG Γκρι / Grey

HQI 400W

AC.045400CW Λευκός / White

AC.045400CO Μαύρος / Black

AC.045400CG Γκρι / Grey

Κενός / Empty E27

AC.045400E27W Λευκός / White

AC.045400E27B Μαύρος / Black

Κενός / Empty E40

AC.045400LE Λευκός / White

AC.045400E Μαύρος / Black

AC.045400GE Γκρι / Grey

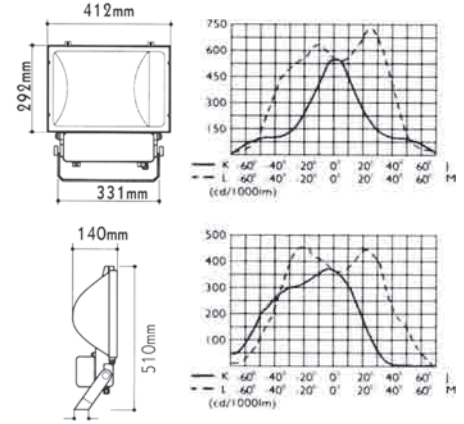

Προβολέας μεταλλικών αλογονιδίων / Metal halide flood luminaire 1000W PROJECT1

IP65



FYGT331II Κενός / Empty

FYGT33111C Με σύστημα έναυσης /
With gear box

- Χυτοπρεσαριστό κράμα αλουμινίου / Die-casting aluminum.
- Πυρίμαχο γυαλί / Fire resistant glass.
- Ντουί / Lampholder E40.

Κατόπιν ερωτήσεως Νατρίου / Sodium under demand

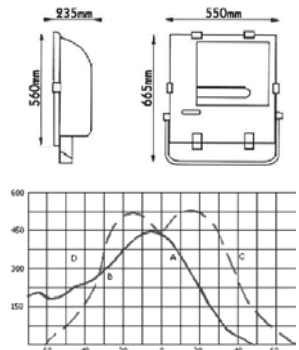

Προβολέας μεταλλικών αλογονιδίων / Metal halide flood luminaire 2000W PROJECT2

IP65



FYGT24



FYG24CL

***FYGT24** Κενός / Empty

FYG24CL Κενός / Empty

- Χυτοπρεσαριστό κράμα αλουμινίου / Die-casting aluminum.
- Πυρίμαχο γυαλί / Fire resistant glass.
- Πλέγμα προστασίας / Protection grid.
- Ντουί / Lampholder E40.

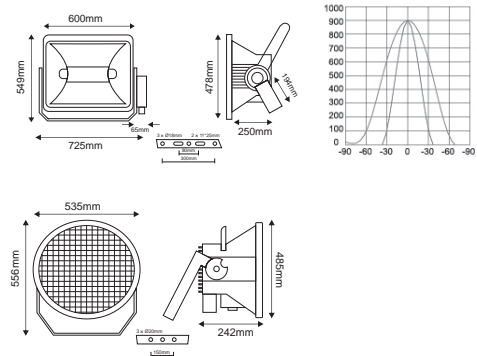

Σύστημα έναυσης / Gear box 1000 - 2000W

IP20



AC.09999



AC.09998

**Σύστημα έναυσης / Gear box 1000W HQI
Για / For PILAR GEAR BOX 1000W HQI**

AC.09999

**Σύστημα έναυσης / Gear box 2000W HQI
Για / For PILAR Λάμπα HQI-T/DI**

AC.09998

- Μαγνητικός μετασχηματιστής / Magnetic ballast ELECTROSTART - CARLOBEZZI.
- Πυκνωτής / Capacitor ICAR.
- Εκκινητής / Ignitor ELECTROSTART.

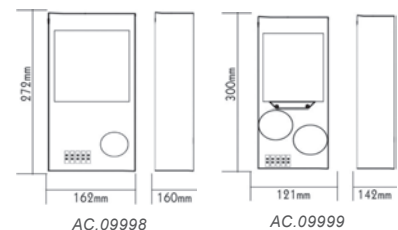

Στο σύστημα έναυσης 2000W δεν συμπεριλαμβάνεται εκκινητής / Ignitor is not included at 2KW gear box

***Υπό κατάργηση / Under abolition**

www.acalight.gr

Φωτιστικά κήπου με βάση για κολώνα Ø60 / Garden luminaires with base for Ø60 pole IP65



AC.18008

230V | E27 max. 40W

AC.18008

AC.18017

*AC.NF1824

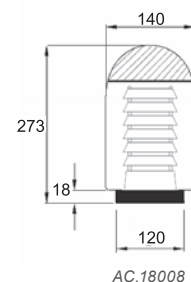

AC.18008



AC.18017

- Πλαστικό ενισχυμένο σώμα με ειδική προστασία ενάντια στη UV ακτινοβολία του ήλιου / Reinforced plastic body with special protection towards sun UV radiation
- Κεραμικό ντουί / Ceramic lampholder E27
- Μεταλλικές περσίδες / Metallic louvers.

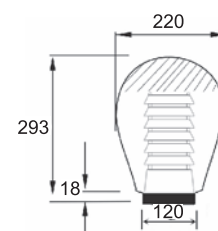

AC.18017



AC.NF1824

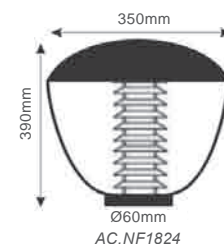

AC.NF1824

Ακρυλική μπάλα με γρίφα / Acrylic sphere with fitter base E27 IP45



AC.3530

230V | E27

Γαλακτερή / Opal

AC.3530 Ø20

AC.3531 Ø25

AC.3532 Ø30

AC.3534 Ø40

AC.3535 Ø50

Διαφανής / Clear

AC.3530T Ø20

AC.3531T Ø25

AC.3532T Ø30

AC.3534T Ø40

Φιμέ / Tinted

AC.3533M Ø15

AC.3530M Ø20

AC.3531M Ø25

AC.3532M Ø30

AC.3534M Ø40



AC.3534T



AC.3530M

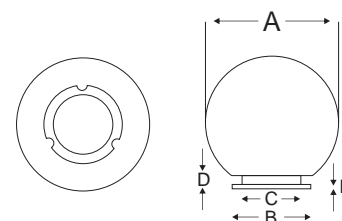

Ø15	A150 x B95 x C78 x D18 x E4
Ø20	A200 x B95 x C78 x D18 x E4
Ø25	A250 x B120 x C95 x D18 x E5
Ø30	A300 x B140 x C115 x D18 x E5
Ø40	A400 x B150 x C113 x D25 x E5
Ø50	A500 x B205 x C178 x D25 x E7

- Πλαστικό ενισχυμένο σώμα με ειδική προστασία ενάντια στη UV ακτινοβολία του ήλιου / Reinforced plastic body with special protection towards sun UV radiation.
- Κεραμικό ντουί / Ceramic lampholder E27.

Πρισματικές ακρυλικές μπάλες με γρίφα / Prismatic acrylic spheres with fitter base E27

IP45



AC.180725C
AC.180730C



AC.18272



AC.180725G
AC.180730G

Διαφανής / Clear

AC.180725C Ø25

AC.180730C Ø30

Φιμέ / Tinted

AC.18272 Ø25

Μελί / Honey

AC.180725G Ø25

AC.180730G Ø30

- Πλαστικό ενισχυμένο σώμα με ειδική προστασία ενάντια στη UV ακτινοβολία του ήλιου / Reinforced plastic body with special protection towards sun UV radiation.
- Κεραμικό ντουί / Ceramic lampholder E27.

Πρισματικές ακρυλικές οβαλ μπάλα με γρίφα / Prismatic acrylic oval spheres with fitter base E27

IP45



AC.1837LG



AC.1837LO
AC.1837SO



AC.1837G
AC.1837



AC.1837SG

Γαλακτερή / Opal

*AC.1837LO Ø37

AC.1837SO Ø32

Μελί / Honey

AC.1837LG Ø37

Φιμέ Μελί / Tint Honey

AC.1837G Ø37

AC.1837 Ø32

Φιμέ / Tint

AC.1837SG Ø32

- Πλαστικό ενισχυμένο σώμα με ειδική προστασία ενάντια στη UV ακτινοβολία του ήλιου / Reinforced plastic body with special protection towards sun UV radiation.
- Κεραμικό ντουί / Ceramic lampholder E27.

Ακρυλικές μπάλες χωρίς γρίφα / Acrylic spheres without fitter base E27



AC.3532C

AC.3531C Ø25

AC.3532C Ø30

AC.3534CA Ø40

AC.3534C Ø40
για γρίφα αλουμινίου /
For aluminum base

AC.3530G γρίφα για
μπάλα Ø20

AC.3531G γρίφα για
μπάλα Ø25

AC.3532G γρίφα για
μπάλα Ø30

AC.3534G γρίφα για
μπάλα Ø40



AC.3534G

Γρίφες χυτού αλουμινίου / Die-casting aluminum fitter bases E27

IP45



ARGF Χωρίς σύστημα έναυσης /
Without gear box

ARGF40 70W Νατρίου / Sodium

Ακρυλικές κρεμαστές μπάλες με ανάρτηση / Acrylic pendant spheres with suspension E27

IP45



AC.18250KGO

AC.18250KOP

230V | E27 max. 40W

AC.18250KOP Ø25 Γαλακτερή / Opal

AC.18250KCL Ø25 Διαφανής / Transparent

AC.18250KGO Ø25 Κεχριμπάρι / Amber

AC.18250KSM Ø25 Φιμέ / Tint

- Πλαστικό ενισχυμένο σώμα με ειδική προστασία ενάντια στη UV ακτινοβολία του ήλιου / Reinforced plastic body with special protection towards sun UV radiation.
- PVC καλώδιο 1 μέτρου / 1m PVC cable.
- Μεταλλική βάση ανάρτησης / Metallic suspension base.
- Ντουί / Lampholder E27.

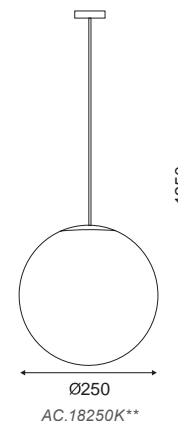

AC.18250KSM

AC.18250KCL

230V | E27 max. 40W
Πρισματική / Prismatic

AC.18272GH Ø25 Μέλι / Honey

Οβάλ πρισματική / Oval prismatic

AC.1837LGH Ø36 Μέλι / Honey

- Πλαστικό ενισχυμένο σώμα με ειδική προστασία ενάντια στη UV ακτινοβολία του ήλιου / Reinforced plastic body with special protection towards sun UV radiation.
- PVC καλώδιο 1 μέτρου / 1m PVC cable.
- Ντουί / Lampholder E27.

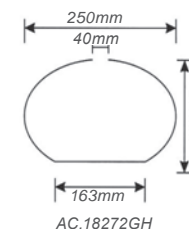

AC.1837LGH

AC.18272GH

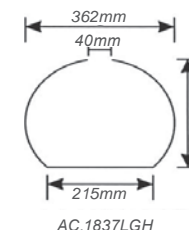

AC.18W

230V | E27 max. 40W
Ανάρτηση / Suspension

AC.18W 0,8m Λευκή / White

Πρισματικές ακρυλικές μπάλες με βάση για κολώνα Ø60
Prismatic acrylic spheres with base for Ø60 pole

IP45



AC.3533GO



AC.3533SM

230V | E27 max. 40W

AC.3533GO Κεχριμπάρι / Amber Ø15

AC.3533SM Φιμέ / Tint Ø15

- Πλαστικό ενισχυμένο σώμα με ειδική προστασία ενάντια στη UV ακτινοβολία του ήλιου / Reinforced plastic body with special protection towards sun UV radiation.
- Κεραμικό ντουί / Ceramic lampholder E27.

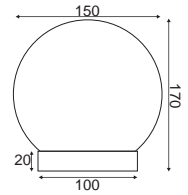

AC.3533**

Απλίκες με ακρυλική μπάλα / Wall luminaires with acrylic sphere E27

IP45



AC.1801PO



AC.1801L

230V | E27 max. 40W

AC.1801PO Γαλακτερή / Opal

AC.1801PM Φιμέ / Tinted

AC.1801LM Φιμέ / Tinted

AC.1801L Γαλακτερή / Opal

- Πλαστικό ενισχυμένο σώμα με ειδική προστασία ενάντια στη UV ακτινοβολία του ήλιου / Reinforced plastic body with special protection towards sun UV radiation.
- Κεραμικό ντουί / Ceramic lampholder E27.

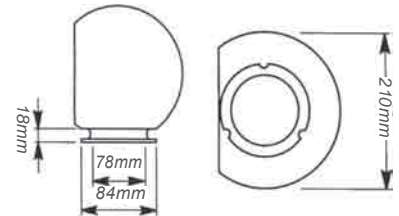

AC.1801P*

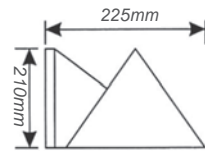

AC.1801L*



AC.1801PM



AC.1801LM

230V | E27 max. 40W

Βάση απλίκας για ακρυλική μπάλα
Wall luminaire base for acrylic ball

AC.280W1 Για μπάλα / For sphere Ø15-Ø20

AC.280W3 Για μπάλα / For sphere Ø15 35316N

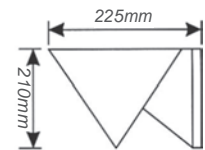

AC.1801L*

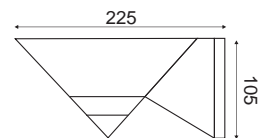

AC.280W1



AC.280W1



AC.280W3

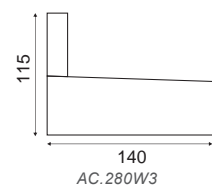

AC.280W3

Πολυκαρβονικός σύνδεσμος στήριξης για ακρυλικές μπάλες / PC mounting connector for acrylic spheres

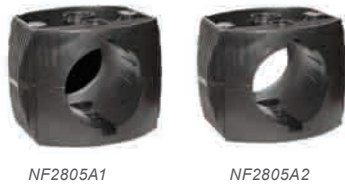

NF2805A1 Για 2 μπάλες / For 2 spheres
NF2805A2 Για 3 μπάλες / For 3 spheres



Βάσεις γλόμπου - πλαστικός γλόμπος / Acrylic spheres & bases



3533 Βάση γλόμπου κυρτή / Curved sphere base
3534 Βάση γλόμπου ίσια / Straight sphere base
35316N Γλόμπος πλαστικός / Plastic sphere Ø15
35317N Γλόμπος πλαστικός / Plastic sphere Ø20

Βάση “καλάθi” για μπάλες / “Basket” base for spheres



AC.NF2804A1 Για μπάλα / For sphere Ø25

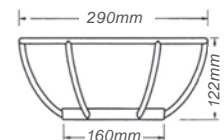

Πολυκαρβονικό κολωνάκι για μπάλες / PC pole for spheres



AC.28021 118 x 60mm
AC.28022 180 x 60mm

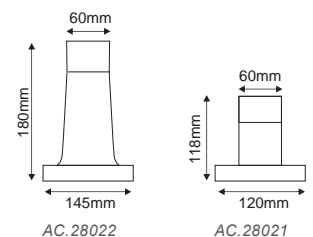

Πολυκαρβονικός βραχίονας τοιχου για μπαλες / PC wall bracket for spheres E27



AC.28031 190 x 60mm Για μπάλες / For spheres Ø15, Ø20, Ø25, Ø30
AC.28032 267 x 60mm Για μπάλες / For spheres Ø35, Ø40

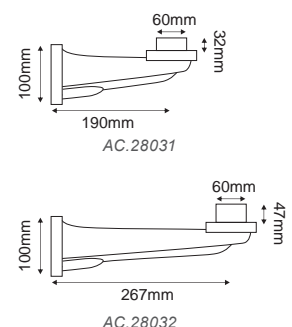

Περίδες πλαστικές & αλουμινίου E27 για μπάλες / Plastic & aluminum louvers E27 for spheres



NF4802AB NF4802AC NF4802AG NF4802AY

NF4802AG Πράσινη / Green

NF4802AY Κίτρινη / Yellow

NF4802AB Μπλε / Blue

NF4802AC Διαφανή / Clear

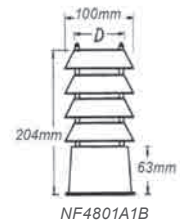

NF4801A1B



NF4801A1B AC.4801A3

AC.4801A3 Ø40 Με 6 νίκελ

δακτυλίδια / 6 nickel rings

NF4801A1B Ø30 Με 4 νίκελ

δακτυλίδια / 4 nickel rings

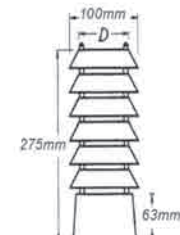

AC.4801A3

Πολυκαρβονικός σωλήνας Ø60 και βάση για μπάλες / PC tube Ø60 and tube base for spheres



AC.NFW6010

AC.NFWA1

AC.NFW6005 Σωλήνας / Tube 0.5m

AC.NFW6010 Σωλήνας / Tube 1m

AC.NFWA1 Βάση σωλήνα / Tube base

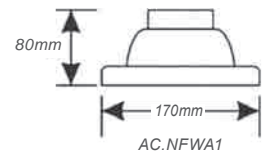

AC.NFWA1

Κολωνάκι αλουμινίου για μπάλες & φανάρια Ø60 / Poles for spheres & lanterns Ø60



HIPC500G

HIPC500B Μαύρο / Black 0,5m

HIPC500G Χρυσό-μαύρο / Gold-black 0,5m

HIPC500V Πράσινο-μαύρο / Green-black 0,5cm

HIPC1000B Μαύρο / Black 1,0m

HIPC1000G Χρυσό-μαύρο / Gold-black 1,0m

HIPC1000V Πράσινο-μαύρο / Green-black 1,0m

HIPC1000R Σκουριά / Rust 1,0m

ΜΑΥΡΟ
BLACK



ΧΡΥΣΟ-ΜΑΥΡΟ
GOLD-BLACK



ΠΡΑΣΙΝΟ-ΜΑΥΡΟ
GREEN-BLACK



ΣΚΟΥΡΙΑ
RUST



Πλαστικά φανάρια κήπου / Plastic garden lanterns

IP44



230V | ECO E27 max. 40W / LED E27 max. 10W

Τετράγωνο / Square

ΓΕΝ. ΣΥΣΚΕΥΑΣΙΑ
MASTER PACKING

PLGP1R Σκουριά φανάρι τοίχου / Rust wall lantern	8
PLGP1W Λευκό φανάρι τοίχου / White wall lantern	8
PLGP1B Μαύρο φανάρι τοίχου / Black wall lantern	8
PLGP3R Σκουριά φανάρι δαπέδου / Rust floor lantern	6
PLGP3W Λευκό φανάρι δαπέδου / White floor lantern	6
PLGP3B Μαύρο φανάρι δαπέδου / Black floor lantern	6
PLGP5R Σκουριά κολώνα με φανάρι / Rust pole with lantern	6
PLGP5W Λευκή κολώνα με φανάρι / White pole with lantern	6
PLGP5B Μαύρη κολώνα με φανάρι / Black pole with lantern	6

230V | ECO E27 max. 40W / LED E27 max. 10W

Εξάγωνο / Hexagon

ΓΕΝ. ΣΥΣΚΕΥΑΣΙΑ
MASTER PACKING

PLGQ1R Σκουριά φανάρι τοίχου / Rust wall lantern	16
PLGQ1W Λευκό φανάρι τοίχου / White wall lantern	16
PLGQ1B Μαύρο φανάρι τοίχου / Black wall lantern	16
PLGQ3R Σκουριά φανάρι δαπέδου / Rust floor lantern	6
PLGQ3W Λευκό φανάρι δαπέδου / White floor lantern	6
PLGQ3B Μαύρο φανάρι δαπέδου / Black floor lantern	6
PLGQ5R Σκουριά κολώνα με φανάρι / Rust pole with lantern	6
PLGQ5W Λευκή κολώνα με φανάρι / White pole with lantern	6
PLGQ5B Μαύρη κολώνα με φανάρι / Black pole with lantern	6

- Σώμα από πολυκαρβονικό πλαστικό / PC plastic body.
- Πυρίμαχο διαφανές γυαλί 4mm / Fire-resistant clear glass 4mm.
- Κολώνα από πολυπροπυλένιο / PP pole (PLGP5* & PLGQ5*).
- Ειδική προστασία ενάντια στη UV ακτινοβολία / Special protection towards UV radiation.



2 τρόποι εγκατάστασης / 2 installation ways

ΣΕ ΠΑΡΑΓΓΕΛΙΑ ΓΕΝ. ΣΥΣΚΕΥΑΣΙΑΣ ΕΠΙΠΛΕΟΝ ΕΚΠΤΩΣΗ 5%
FOR MASTER PACKING ORDER EXTRA DISCOUNT 5%

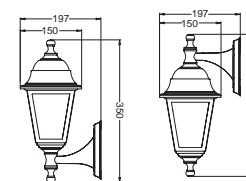

PLGP1*

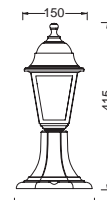

PLGP3*

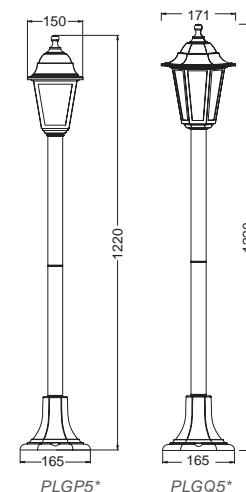

PLGP5*

PLGQ5*

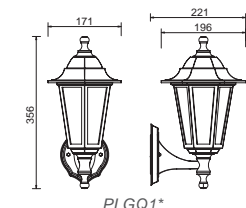

PLGQ1*



PLGQ3*



Τα τεχνικά στοιχεία του προϊόντος (Χρώμα-Διάσταση) ενδέχεται να διαφέρουν από τα αναγραφόμενα με μια απόκλιση +/- 10%
The technical data (Color-Dimension) of the product may differ from the listed +/- 10%

Πλαστικά φωτιστικά κήπου / Plastic garden luminaires

IP44



PLGM5B

PLGM5W

230V
ECO E27 max. 40W / LED E27 max. 10W ΓΕΝ. ΣΥΣΚΕΥΑΣΙΑ MASTER PACKING

PLGM1W Λευκό φωτιστικό τοίχου / White wall luminaire	8
PLGM1B Μαύρο φωτιστικό τοίχου / Black wall luminaire	8
PLGM3W Λευκό φωτιστικό εδάφους / White floor luminaire	6
PLGM3B Μαύρο φωτιστικό εδάφους / Black floor luminaire	6
PLGM5W Λευκή κολώνα με μπάλα / White pole with ball	6
PLGM5B Μαύρη κολώνα με μπάλα / Black pole with ball	6

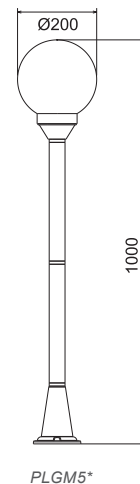

PLGM5*



PLGM1B

PLGM1W

- Σώμα από πολυκαρβονικό πλαστικό / PC plastic body.
- Οπάλ πολυκαρβονική μπάλα / Opal PC ball.
- Κολώνα από αλουμίνιο / Aluminum pole (PLGM5*).
- Ειδική προστασία ενάντια στη UV ακτινοβολία / Special protection towards UV radiation.

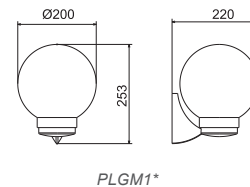

PLGM1*



PLGM3B

PLGM3W



2 τρόποι εγκατάστασης / 2 installation ways

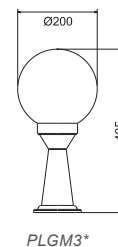

PLGM3*

Φωτιστικά κήπου / Garden luminaires CYCLEA

IP54



CYCLEA1M

CYCLEA

230V
ECO E27 max. 25W / LED E27 max. 6W ΓΕΝ. ΣΥΣΚΕΥΑΣΙΑ MASTER PACKING

CYCLEA Επίτοιχη απλίκα / Wall luminaire	12
CYCLEA1M Φωτιστικό δαπέδου / Floor luminaire	4

- Σώμα από χυτό αλουμίνιο / Die-casting aluminum body.
- Πλαστικό διάφανο κάλυμμα με ειδική προστασία στη UV ακτινοβολία / Reinforced plastic clear cover with special protection towards UV radiation.

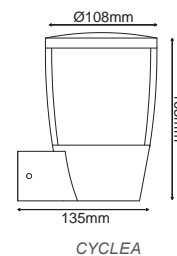

CYCLEA

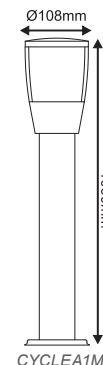

CYCLEA1M

ΓΚΡΙ
GREY



Σημείωση: Ο λαμπτήρας LED E27 που θα εγκατασταθεί πρέπει να είναι ονομαστικής ισχύς max. 6W και δεν συμπεριλαμβάνεται
Notice: The maximum wattage of the E27 LED lamp that is going to be installed inside is 6W and is not included.

Φανάρια αλουμινίου εξάγωνα / Hexagon aluminum lanterns E27

IP45



HI6021V



HI6022W



HI6023R



HI6024GB



HI6025

230V | E27 max. 60W

HI6021W Λευκό / White

HI6021B Μαύρο / Black

HI6021V Πράσινο-μαύρο / Green-black

HI6021GB Χρυσό-μαύρο / Gold-black

HI6021R Σκουριά / Rust

HI6022W Λευκό / White

HI6022B Μαύρο / Black

HI6022V Πράσινο-μαύρο / Green-black

HI6022GB Χρυσό-μαύρο / Gold-black

HI6022R Σκουριά / Rust

HI6023W Λευκό / White

HI6023B Μαύρο / Black

HI6023V Πράσινο-μαύρο / Green-black

HI6023GB Χρυσό-μαύρο / Gold-black

HI6023R Σκουριά / Rust

HI6024W Λευκό / White

HI6024B Μαύρο / Black

HI6024V Πράσινο-μαύρο / Green-black

HI6024GB Χρυσό-μαύρο / Gold-black

HI6025W Λευκό / White

HI6025B Μαύρο / Black

HI6025V Πράσινο-μαύρο / Green-black

HI6025GB Χρυσό-μαύρο / Gold-black

- Χυτό αλουμίνιο / Die-casting aluminum.
- Διαφανές γυαλί / Transparent glass.
- Ντουί / Lampholder E27.

ΛΕΥΚΟ
WHITE

ΜΑΥΡΟ
BLACK

ΧΡΥΣΟ-ΜΑΥΡΟ
GOLD-BLACK

ΠΡΑΣΙΝΟ-ΜΑΥΡΟ
GREEN-BLACK

ΣΚΟΥΡΙΑ
RUST



HI6021

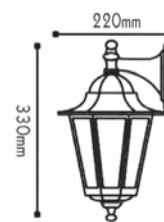

HI6022



HI6023

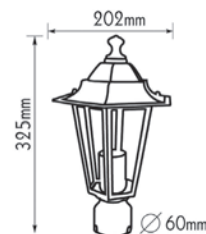

HI6024



HI6025

Τα τεχνικά στοιχεία του προϊόντος (Χρώμα-Διάσταση) ενδέχεται να διαφέρουν από τα αναγραφόμενα με μια απόκλιση +/- 10%
The technical data (Color-Dimension) of the product may differ from the listed +/- 10%

Φανάρια αλουμινίου τετράγωνα / Square aluminum lanterns E27

IP45



HI6041W



HI6042V



HI6043R



HI6044GB



HI6045B

230V | E27 max. 60W

HI6041W Λευκό / White

HI6041B Μαύρο / Black

HI6041V Πράσινο-μαύρο / Green-black

HI6041GB Χρυσό-μαύρο / Gold-black

HI6041R Σκουριά / Rust

HI6042W Λευκό / White

HI6042B Μαύρο / Black

HI6042V Πράσινο-μαύρο / Green-black

HI6042GB Χρυσό-μαύρο / Gold-black

HI6042R Σκουριά / Rust

HI6043W Λευκό / White

HI6043B Μαύρο / Black

HI6043V Πράσινο-μαύρο / Green-black

HI6043GB Χρυσό-μαύρο / Gold-black

HI6043R Σκουριά / Rust

HI6044W Λευκό / White

HI6044B Μαύρο / Black

HI6044V Πράσινο-μαύρο / Green-black

HI6044GB Χρυσό-μαύρο / Gold-black

HI6044R Σκουριά / Rust

HI6045W Λευκό / White

HI6045B Μαύρο / Black

HI6045V Πράσινο-μαύρο / Green-black

HI6045GB Χρυσό-μαύρο / Gold-black

HI6045R Σκουριά / Rust

- Χυτό αλουμίνιο / Die-casting aluminum.
- Διαφανές γυαλί / Transparent glass.
- Ντουί / Lampholder E27.

ΛΕΥΚΟ WHITE ΜΑΥΡΟ BLACK ΧΡΥΣΟ-ΜΑΥΡΟ GOLD-BLACK ΠΡΑΣΙΝΟ-ΜΑΥΡΟ GREEN-BLACK ΣΚΟΥΡΙΑ RUST

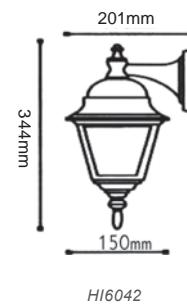
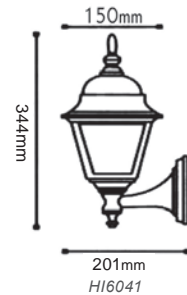

Τα τεχνικά στοιχεία του προϊόντος (Χρώμα-Διάσταση) ενδέχεται να διαφέρουν από τα αναγραφόμενα με μια απόκλιση +/- 10%
The technical data (Color-Dimension) of the product may differ from the listed +/- 10%

Φανάρια αλουμινίου εξάγωνα / Hexagon aluminum lanterns E27

IP45



HI6171V

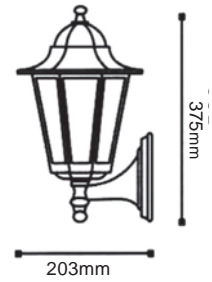

HI6171V

230V | E27 max. 60W

HI6171B Μαύρο / Black

HI6171V Πράσινο-μαύρο / Green-black

HI6171GB Χρυσό-μαύρο / Gold-black

HI6172B Μαύρο / Black

HI6172V Πράσινο-μαύρο / Green-black

HI6172GB Χρυσό-μαύρο / Gold-black

HI6173B Μαύρο / Black

HI6173V Πράσινο-μαύρο / Green-black

HI6173GB Χρυσό-μαύρο / Gold-black

HI6175B Μαύρο / Black

HI6175V Πράσινο-μαύρο / Green-black

HI6175GB Χρυσό-μαύρο / Gold-black



HI6172B

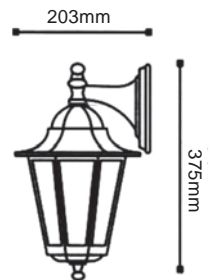

HI6172



HI6173B

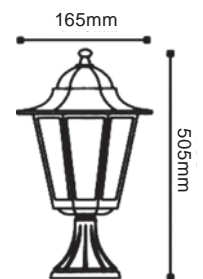

HI6173

- Χυτό αλουμινίου / Die-casting aluminum.
- Διαφανές γυαλί / Transparent glass.
- Ντουί / Lampholder E27.



HI6175GB

ΜΑΥΡΟ
BLACK



ΧΡΥΣΟ-ΜΑΥΡΟ
GOLD-BLACK



ΠΡΑΣΙΝΟ-ΜΑΥΡΟ
GREEN-BLACK



HI6175

Τα τεχνικά στοιχεία του προϊόντος (Χρώμα-Διάσταση) ενδέχεται να διαφέρουν από τα αναγραφόμενα με μια απόκλιση +/- 10%
The technical data (Color-Dimension) of the product may differ from the listed +/- 10%

Φανάρια αλουμινίου στρόγγυλα / Round aluminum lanterns E27

IP45



HI6221V

230V | E27 max. 60W

*HI6221V Πράσινο-μαύρο / Green-black

*HI6222V Πράσινο-μαύρο / Green-black

*HI6223V Πράσινο-μαύρο / Green-black

*HI6223GB Χρυσό-μαύρο / Gold-black

*HI6225B Μαύρο / Black

*HI6225V Πράσινο-μαύρο / Green-black



HI6221



HI6222V



HI6222

- Χυτό αλουμινίου / Die-casting aluminum.
- Διαφανές πλαστικό / Transparent PC.
- Ντουί / Lampholder E27.



HI6223GB

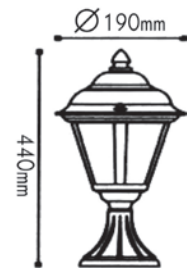

HI6223

230V | E27 max. 60W

*HI6202 Μαύρο / Black



HI6225B

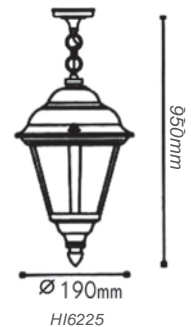

HI6225



HI6202

ΜΑΥΡΟ
BLACK



ΧΡΥΣΟ-ΜΑΥΡΟ
GOLD-BLACK



ΠΡΑΣΙΝΟ-ΜΑΥΡΟ
GREEN-BLACK

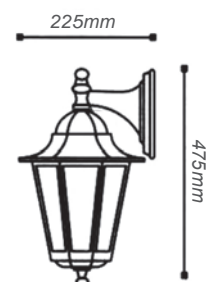

HI6202

Τα τεχνικά στοιχεία του προϊόντος (Χρώμα-Διάσταση) ενδέχεται να διαφέρουν από τα αναγραφόμενα με μια απόκλιση +/- 10%
The technical data (Color-Dimension) of the product may differ from the listed +/- 10%

*Υπό κατάργηση / Under abolition

www.acalight.gr

Επίτοιχα φανάρια αλουμινίου / Wall aluminum lanterns E27

IP44



HI8011B



HI8011R



HI8011GB

230V | E27 max. 100W

HI8011B Μαύρο / Black

HI8011GB Χρυσό-μαύρο / Gold-black

HI8011R Σκουριά / Rust

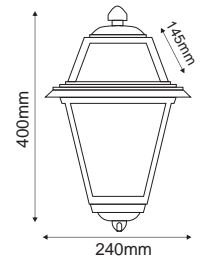

- Χυτό αλουμίνιο / Die-casting aluminum.
- Διαφανές γυαλί / Transparent glass.

MAYPO
BLACK



ΣΚΟΥΡΙΑ
RUST



ΧΡΥΣΟ-ΜΑΥΡΟ
GOLDEN-BLACK



Φανάρι παραδοσιακό / Traditional lantern CRES

IP45



BT5721



HI6501

BT5721 Γυαλί / Glass

HI6501 Γυαλί / Glass

HI6502 Γυαλί / Glass

HI6503 Γυαλί / Glass

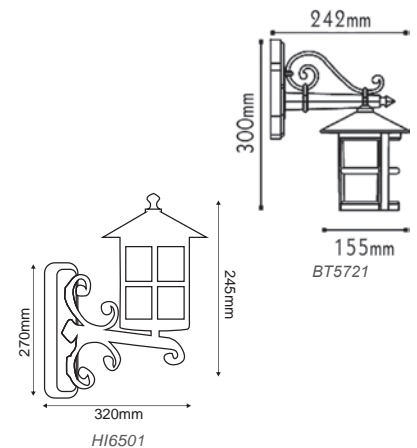

BT5721

- Χυτό αλουμινίου / Die-casting aluminum.
- Διαφανές γυαλί / Transparent glass.
- Ντουί / Lampholder E27.

ΣΚΟΥΡΙΑ
RUST



HI6502



HI6503

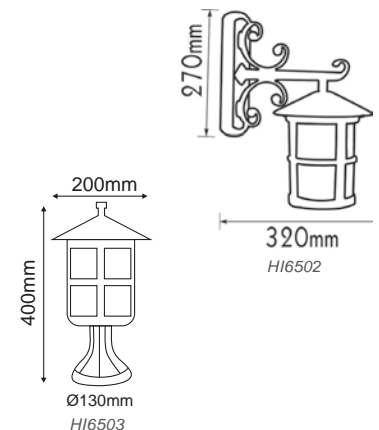

HI6502

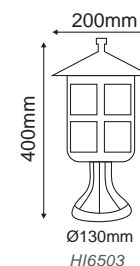

HI6503

Τα τεχνικά στοιχεία του προϊόντος (Χρώμα-Διάσταση) ενδέχεται να διαφέρουν από τα αναγραφόμενα με μια απόκλιση +/- 10%
The technical data (Color-Dimension) of the product may differ from the listed +/- 10%

*Υπό κατάργηση / Under abolition

Φωτιστικά κήπου / Garden luminaires LOOP

IP45

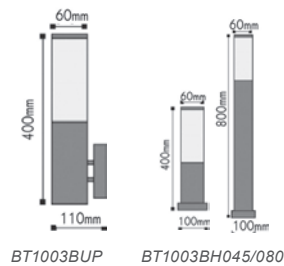
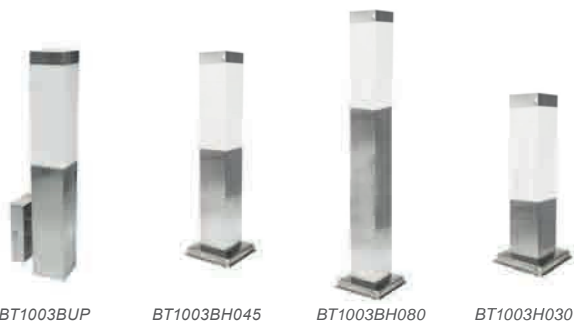

- BT1003BH030
- BT1003BH045
- BT1003BH080
- BT1003BUP
- BT1003WU
- BT1003SO
- BT1003H08
- *BT1008WU
- *BT1008SO
- *BT1008SENSOR
- *HI8123
- HI8133
- HI8134300
- HI8134740

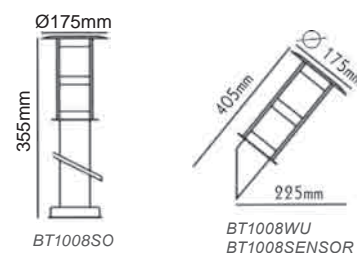
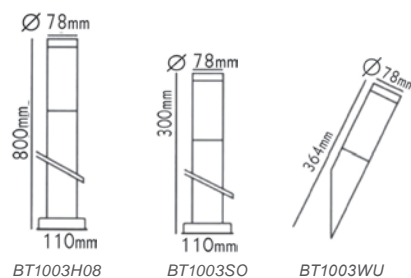
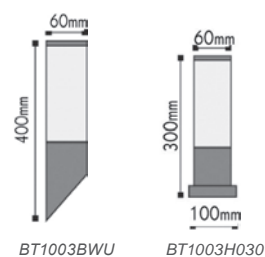

- Ανοξείδωτο ατσάλι / Stainless steel.
- Πλαστικό γαλακτερό κάλυμμα / Milky PC cover.
- (BT1008SO/WU/SENSOR) Γαλακτερό γυαλί / Opal glass.
- Ντουί / Lampholder E27.

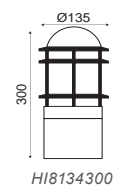
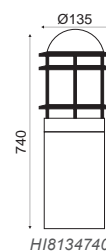
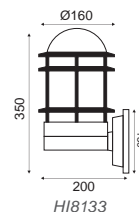

Φωτιστικά κήπου έμμεσου φωτισμού / Indirect lighting garden luminaires CAPO

IP44



HI8171

*HI8171

HI8161

HI8163450

HI81631100

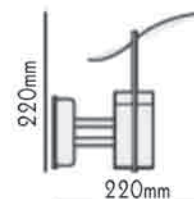

HI8171



HI8161



- Ανοξείδωτο ατσάλι / Stainless steel.
- Πυρίμαχο γυαλί / Fire resistant glass.
- Ντουί / Lampholder GU10.

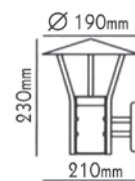

HI8161



HI81631100



HI8163450

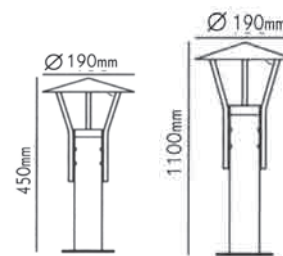

HI8163450

HI81631100

Φωτιστικά κήπου / Garden luminaires DISC

IP45



HI8021

*HI8021 E27 60W

*HI8023500 E27 60W

*HI80231050 E27 60W

*HI8064650 GU10 50W

*HI80641100 GU10 50W

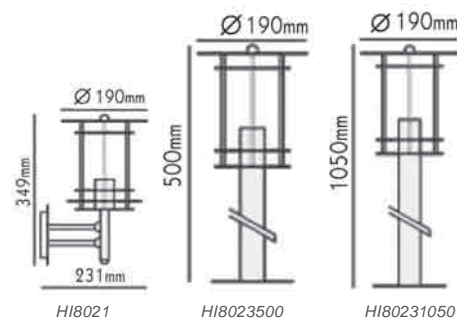

HI8021

HI8023500

HI80231050



HI8023500



HI80231050



- Ανοξείδωτο ατσάλι / Stainless steel.
- Διαφανές πλαστικό / Transparent PC.

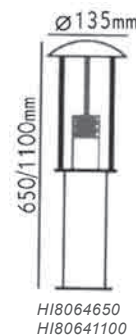

HI8064650
HI80641100

HI8064650
HI80641100

Απλίκες - κολωνάκια κήπου αλουμινίου / Garden aluminum poles - wall luminaires

IP45



HI7261



HI7263

HI7261

HI7262

HI7263

HI1032400 40cm

HI1032650 65cm

HI10321100 110cm

- Χυτό αλουμίνιο / Die-casting aluminum.
- Γαλακτερό πλαστικό / Opal PC.
- Ντουί / Lampholder E27.

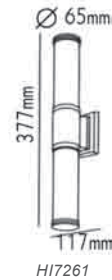

HI7261

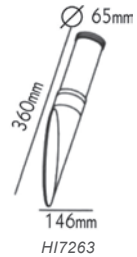

HI7263



HI7262



HI1032400
HI1032650
HI10321100

ΓΚΡΙ
GREY

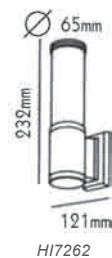

HI7262

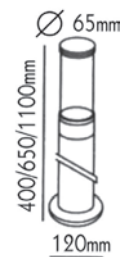

HI1032400
HI1032650
HI10321100

Φωτιστικά κήπου αλουμινίου / Garden aluminum luminaires GRIDA

IP45



HI8363650GR



HI8363650GB

HI8363650GB Χρυσό - μαύρο / Gold - black

HI8363650GR Γραφίτης / Graphite

HI8362GB Χρυσό - μαύρο / Gold - black

HI8362GR Γραφίτης / Graphite

- Χυτό αλουμίνιο / Die-casting aluminum.
- Γαλακτερό γυαλί / Opal glass.
- Ντουί

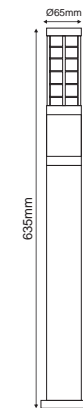

HI8363650GB
HI8363650GR



HI8362GR



HI8362GB

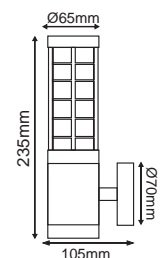

HI8362GR
HI8362GB

ΓΡΑΦΙΤΗΣ
GRAPHITE



ΧΡΥΣΟ-ΜΑΥΡΟ
GOLD-BLACK



Τα τεχνικά στοιχεία του προϊόντος (Χρώμα-Διάσταση) ενδέχεται να διαφέρουν από τα αναγραφόμενα με μια απόκλιση +/- 10%
The technical data (Color-Dimension) of the product may differ from the listed +/- 10%

Βιομηχανική πλαστική απλικά τύπου “χελώνα” / Industrial bulkhead plastic wall luminaire **IP44**



AC.045PBW

ΛΕΥΚΟ
WHITE

ΜΑΥΡΟ
BLACK

ΓΚΡΙ
GREY

AC.045PBB Μαύρο / Black

AC.045PBW Λευκό / White

AC.045PBG Γκρι / Grey

- Ενισχυμένο πλαστικό / Reinforced plastic
- Πρισματικό γυαλί / Frost glass
- Ντουί / Lampholder E27

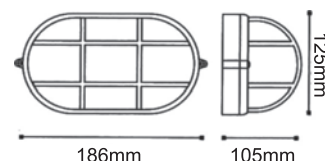

Απλίκες κήπου τύπου “χελώνα” αλουμινίου / Bulkhead aluminum wall luminaires **IP45**



HI5022W

HI5032GB



HI5021G

HI5031R



HI5033W



HI5001W

HI5011B



HI5002G

HI5012GB

HI5011W Λευκό / White

HI5011B Μαύρο / Black

HI5011G Γκρι / Grey

HI5011GB Χρυσό-μαύρο / Gold-black

HI5011R Σκουριά / Rust

HI5012W Λευκό / White

HI5012B Μαύρο / Black

HI5012G Γκρι / Grey

HI5012GB Χρυσό-μαύρο / Gold-black

HI5012R Σκουριά / Rust

HI5021W Λευκό / White

HI5021B Μαύρο / Black

HI5021G Γκρι / Grey

HI5021GB Χρυσό-μαύρο / Gold-black

HI5021R Σκουριά / Rust

HI5022W Λευκό / White

HI5022B Μαύρο / Black

HI5022G Γκρι / Grey

HI5022GB Χρυσό-μαύρο / Gold-black

HI5022R Σκουριά / Rust

HI5001W Λευκό / White

HI5001B Μαύρο / Black

HI5001G Γκρι / Grey

HI5001GB Χρυσό-μαύρο / Gold-black

HI5001R Σκουριά / Rust

HI5002W Λευκό / White

HI5002B Μαύρο / Black

HI5002G Γκρι / Grey

HI5002GB Χρυσό-μαύρο / Gold-black

HI5002R Σκουριά / Rust

HI5031W Λευκό / White

HI5031B Μαύρο / Black

HI5031G Γκρι / Grey

HI5031GB Χρυσό-μαύρο / Gold-black

HI5031R Σκουριά / Rust

HI5032W Λευκό / White

HI5032B Μαύρο / Black

HI5032G Γκρι / Grey

HI5032GB Χρυσό-μαύρο / Gold-black

HI5032R Σκουριά / Rust

HI5033W Λευκό / White

HI5033B Μαύρο / Black

HI5033G Γκρι / Grey

HI5033GB Χρυσό-μαύρο / Gold-black

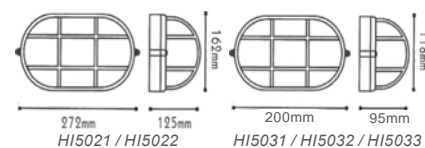
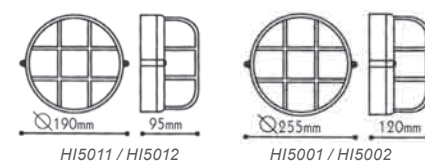

- Χυτό αλουμίνιο / Die-casting aluminum.
- Πρισματικό γυαλί / Prismatic glass.
- Ντουί / Lampholder E27.

ΛΕΥΚΟ
WHITE

ΜΑΥΡΟ
BLACK

ΓΚΡΙ
GREY

ΧΡΥΣΟ-ΜΑΥΡΟ
GOLD-BLACK

ΣΚΟΥΡΙΑ
RUST

Τα τεχνικά στοιχεία του προϊόντος (Χρώμα-Διάσταση) ενδέχεται να διαφέρουν από τα αναγραφόμενα με μια απόκλιση +/- 10%
The technical data (Color-Dimension) of the product may differ from the listed +/- 10%

Απλίκες κήπου τύπου “χελώνα” αλουμινίου / Bulkhead aluminum wall luminaires

IP45



HI5042G



HI5044G

HI5072W Λευκό / White

HI5072B Μαύρο / Black

HI5072G Γκρι / Grey

HI5072GB Χρυσό-μαύρο / Gold-black

HI5073W Λευκό / White

HI5073B Μαύρο / Black

HI5073G Γκρι / Grey

HI5073GB Χρυσό-μαύρο / Gold-black

HI5074W Λευκό / White

HI5074B Μαύρο / Black

HI5074G Γκρι / Grey

HI5074GB Χρυσό-μαύρο / Gold-black

HI5042W Λευκό / White

HI5042B Μαύρο / Black

HI5042G Γκρι / Grey

HI5042GB Χρυσό-μαύρο / Gold-black

HI5044W Λευκό / White

HI5044B Μαύρο / Black

HI5044G Γκρι / Grey

HI5044GB Χρυσό-μαύρο / Gold-black

HI5261W Λευκό / White

HI5261B Μαύρο / Black

HI5261G Γκρι / Grey

HI5262W Λευκό / White

HI5262B Μαύρο / Black

HI5263W Λευκό / White

HI5263B Μαύρο / Black

HI5263G Γκρι / Grey

HI5132 Γκρι / Grey

HI5133 Γκρι / Grey

HI5122 Γκρι / Grey

HI5123 Γκρι / Grey

HI5171W Λευκό / White

HI5171B Μαύρο / Black

HI5171G Γκρι / Grey

HI5172W Λευκό / White

HI5172B Μαύρο / Black

HI5172G Γκρι / Grey

HI5191 Γκρι / Grey

HI5192 Γκρι / Grey

HI5193 Γκρι / Grey

HI5194 Γκρι / Grey

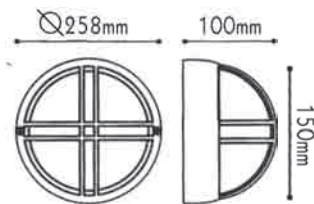

HI5042 / HI5044

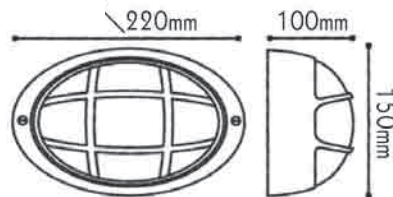

HI5072 / HI5073 / HI5074

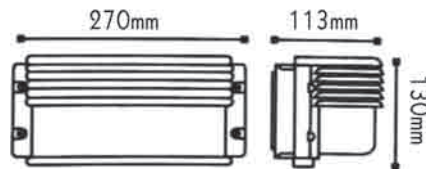

HI5261 / HI5262 / HI5263

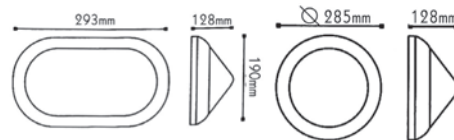

HI5132 / HI5133

HI5122 / HI5123

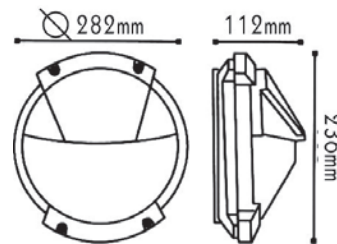

HI5171 / HI5172

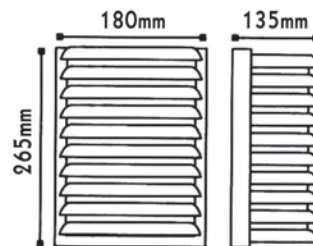

HI5191 / HI5192 / HI5193 / HI5194



HI5072GB



HI5261G



HI5073B



HI5262B



HI5074GB



HI5263B



HI5132



HI5133



HI5122



HI5123



HI5191



HI5192



HI5172WB/G



HI5193



HI5194



HI5171B

ΛΕΥΚΟ
WHITE

ΜΑΥΡΟ
BLACK

ΓΚΡΙ
GREY

ΧΡΥΣΟ-ΜΑΥΡΟ
GOLD-BLACK

- Χυτό αλουμίνιο / Die-casting aluminum.
- Πρισματικό γυαλί / Prismatic glass.
- Ντουσι / Lampholder E27.

Τα τεχνικά στοιχεία του προϊόντος (Χρώμα-Διάσταση) ενδέχεται να διαφέρουν από τα αναγραφόμενα με μια απόκλιση +/- 10%
The technical data (Color-Dimension) of the product may differ from the listed +/- 10%

Απλικές εξωτερικών χώρων / Outdoor wall luminaires RADES

IP45



HI8154

HI8155

HI8154 Νικελ ματ / Nickel matt

HI8155 Γκρι / Grey

OPAL PC

HI8142 Νικελ ματ / Nickel matt



HI8142

- Ανοξείδωτο ατσάλι / Stainless steel.
- Πρισματικό - γαλακτερό γυαλί / Prismatic - opal glass.
- Ντουί / Lampholder E27.

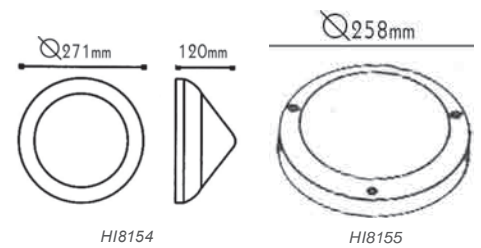

HI8154

HI8155

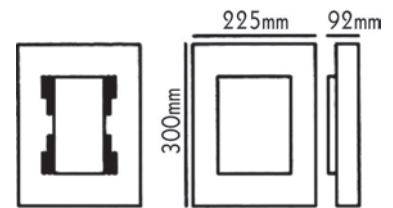

HI8142

Απλικές εξωτερικών χώρων αλουμινίου / Outdoor aluminum wall luminaires CUBE

IP54



HI5601

HI5502

HI5702



HI5701

HI5703



HI5612



HI5611

HI5601 2 x E27

HI5502 2 x E27

HI5701 E27

HI5702 E27

HI5703 E27

HI5611 2 x E27

HI5612 2 x E27

- Χυτό αλουμίνιο / Die-casting aluminum.
- Πολυκαρβονικό γαλακτερό κάλυμμα/ PC opal cover.
- Ντουί / Lampholder E27.

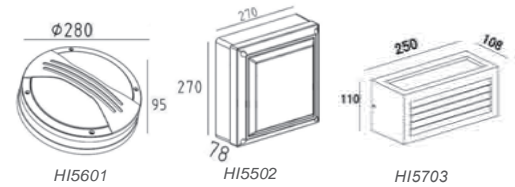

HI5601

HI5502

HI5703

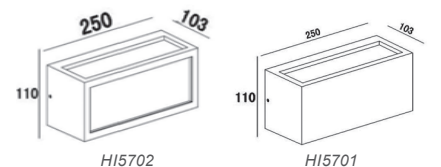

HI5702

HI5701

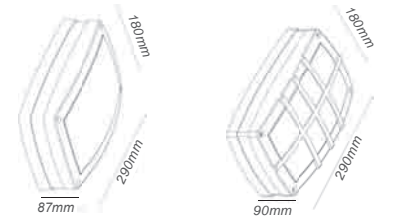

HI5612

HI5611

Απλικές διαδρόμων αλουμινίου / Corridor aluminum wall luminaires BERE

IP54



AC.045BS9222W

AC.045BS9223W

12V | G4 max. 20W

AC.045D02A Μαύρο / Black

AC.045BS9223W Λευκό / White

AC.045BS9223EG Γκρι / Grey

AC.045BS9222 Μαύρο / Black

AC.045BS9222W Λευκό / White

AC.045BS9222EG Γκρι / Grey



HI4142

HI4143

230V | G9 max. 20W

*HI4142 Γκρι / Grey

*HI4143 Γκρι / Grey

- Χυτό ή ανοδιωμένο αλουμίνιο / Die-casting or anodised aluminum.
- Πρισματικό γυαλί / Prismatic glass.

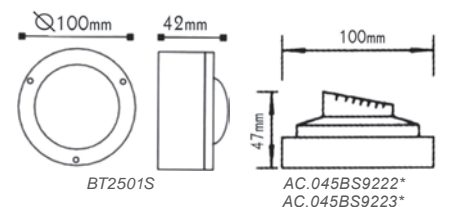

BT2501S

AC.045BS9222*
AC.045BS9223*

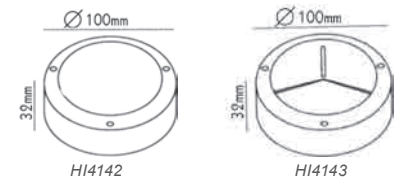

HI4142

HI4143



Σποτ οροφής / Spot ceiling luminaires ANCE

IP65



ΓΚΡΙ
GREY

XF9018GU10

230V | GU10 max. 50W

*XF9018GU10

- Χυτό αλουμίνιο / Die-casting aluminum
- Διαφανές πυρίμαχο γυαλί / Transparent fire resistant glass
- Ντου / Lampholder GU10

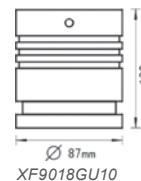

Απλίκες διαδρόμων / Corridor wall luminaires

IP54



HI019CG9



HI19AG9

230V | G9 max. 40W

*HI019AG9 Εξωτερικό / surface

HI019CG9 Εξωτερικό / surface

230V | E27 max. 40W

HI7002E27 Χωνευτό / Recessed

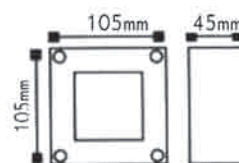

HI019CG9
HI19AG9



HI7002E27

ΝΙΚΕΛ
NICKEL

- Ανοξειδωτο ασάμι / Stainless steel.
- Ματ πυρίμαχο γυαλί / Fire-resistant mat glass.

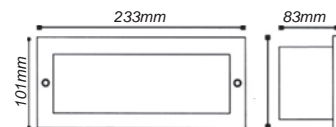

HI7002E27

Απλίκες χωνευτές αλουμινίου / Recessed wall aluminum luminaires

IP54



AC.045GL63B



AC.045GL64B Μαύρο / Black E27

AC.045GL64W Λευκό / White E27

AC.045GL64G Γκρι / Grey E27

AC.045GL63B Μαύρο / Black E27

AC.045GL63W Λευκό / White E27

AC.045GL63G Γκρι / Grey E27

*XFWL81G9 Γκρι / Grey G9

*XFWL81AG9 Γκρι / Grey G9



AC.045GL64B

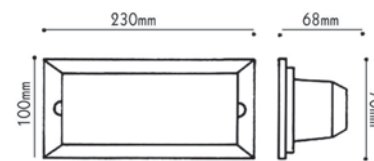

AC.045GL64B
AC.045GL63B

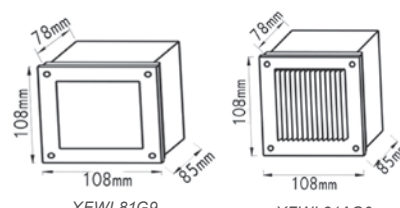

XFWL81G9

XFWL81AG9

- Σώμα χυτού αλουμινίου / Die-casting aluminum body.
- Πυρίμαχο γυαλί / Fire-resistant glass.
- Ντου / Lampholder G9, E27.

ΛΕΥΚΟ
WHITE

ΜΑΥΡΟ
BLACK

ΓΚΡΙ
GREY



XFWL81G9



XFWL81AG9

Πλαστικά σποτ τοίχου GU10 / GU10 plastic wall luminaires KERT

IP54



230V | GU10 max. 5W LED

ΓΕΝ. ΣΥΣΚΕΥΑΣΙΑ
MASTER PACKING

KERTGU10W Λευκό / White	20
KERTGU10B Μαύρο / Black	20
KERTGU10G Γκρι / Grey	20

Σετ 3 χρωματιστών φακών / Colorful 3 lenses kit

KERTCOV Πράσινος - πορτοκαλί - μωβ φακός /
Green - orange - purple lens

- Πλαστικό ενισχυμένο σώμα με ειδική προστασία ενάντια στη UV ακτινοβολία του ήλιου / Reinforced plastic body with special protection towards sun UV radiation.
- Πλαστικό οπάλ κάλυμμα / Plastic opal cover.
- Θερμοκρασία λειτουργίας -15°~+50°C / Operating temperature -15°~+50°C.
- Ρυθμιζόμενος βραχίονας / Adjustable bracket 0-240°.
- Φλάντζα στεγανοποίησης / Waterproof flange.



ΣΕ ΠΑΡΑΓΓΕΛΙΑ ΓΕΝ. ΣΥΣΚΕΥΑΣΙΑΣ ΕΠΙΠΛΕΟΝ ΕΚΠΤΩΣΗ 5%
FOR MASTER PACKING ORDER EXTRA DISCOUNT 5%

Πλαστικά σποτ κήπου GU10 / GU10 plastic garden spot luminaires KERTS

IP54



GU10 max. 5W LED

ΓΕΝ. ΣΥΣΚΕΥΑΣΙΑ
MASTER PACKING

KERTSGU10B Μαύρο / Black	20
--------------------------	----

Σετ 3 χρωματιστών φακών / Colorful 3 lenses kit

KERTCOV πράσινος - πορτοκαλί - μωβ φακός /
green - orange - purple lens

- Πλαστικό ενισχυμένο σώμα με ειδική προστασία ενάντια στη UV ακτινοβολία του ήλιου / Reinforced plastic body with special protection towards sun UV radiation.
- Πλαστικό οπάλ κάλυμμα / Plastic opal cover.
- Θερμοκρασία λειτουργίας -15°~+50°C / Operating temperature -15°~+50°C.
- Ρυθμιζόμενος βραχίονας / Adjustable bracket 0-300°.
- Φλάντζα στεγανοποίησης / Waterproof flange.
- Δυνατότητα σύνδεσης σε σειρά μέσω επιπλέον στεγανού στυπιοθλίπτη που συμπεριλαμβάνεται / Can be connected in series through extra waterproof connector which is included.

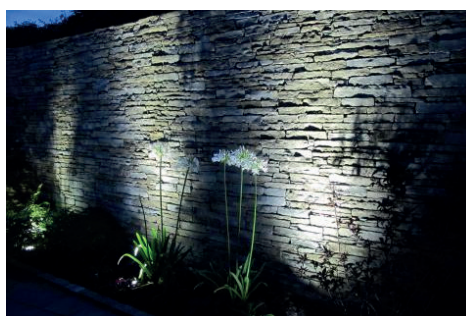
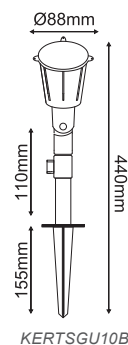

ΣΕ ΠΑΡΑΓΓΕΛΙΑ ΓΕΝ. ΣΥΣΚΕΥΑΣΙΑΣ ΕΠΙΠΛΕΟΝ ΕΚΠΤΩΣΗ 5%
FOR MASTER PACKING ORDER EXTRA DISCOUNT 5%

Σποτ κήπου πλαστικά / Garden plastic luminaires PAR38



AC.045GL78 AC.045GL79 AC.045GL76

- AC.045GL76 Μαύρο / Black
- AC.045GL77 Μαύρο / Black
- AC.045GL78 Μαύρο / Black
- AC.045GL79 Μαύρο / Black
- AC.045GL77G Πράσινο / Green
- AC.045GL79G Πράσινο / Green

- Πολυκαρβονικό πλαστικό / PC plastic.
- Ενισχυμένο ενάντια στη UV ακτινοβολία / Reinforced against UV Rays.
- Φλάντζα στεγανοποίησης / Waterproof flange.
- Ντουί / Lampholder E27.

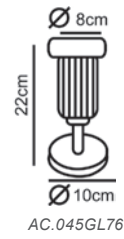

AC.045GL76

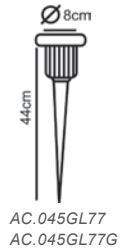

AC.045GL77
AC.045GL77G



AC.045GL77G AC.045GL79G AC.045GL77



Συνδυάστε το με
Λαμπτήρα LED PAR38
IP65 πράσινο ή R.G.B.
με τηλεχειριστήριο

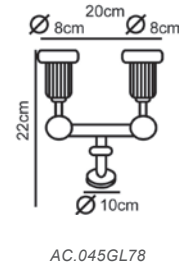

AC.045GL78

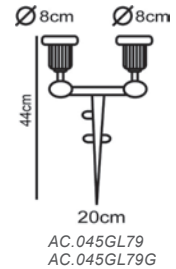

AC.045GL79
AC.045GL79G

Σποτ κήπου αλουμινίου / Garden aluminum luminaires SPIKER

IP65



AC.045XF828A HI7183R

230V | Halogen R7s max. 150W

*AC.045XF828A Μαύρο / Black

*AC.045XF828AG Γκρι / Grey

230V | GU10 max. 35W

HI7183 Γκρι / Grey

HI7183B Μαύρο / Black

HI7183R Σκουριά / Rust

- Χυτό αλουμίνιο / Die-casting aluminum.
- Πυρίμαχο γυαλί / Fire resistant glass.

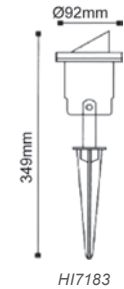

HI7183

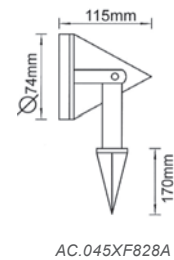

AC.045XF828A

Σποτ κήπου αλουμινίου / Garden aluminum luminaires

IP65



BT9013AG HI7182NGR

BT9013GBR

BT9013R

230V | GU10 max. 35W

12V | GU5.3 MR16 max. 35W

BT9013W GU10 Λευκό / White

BT9013A GU10 Γκρι / Grey

BT9013B GU10 Μαύρο / Black

BT9013GBR GU10 Χρυσό μαύρο / Gold black

BT9013R GU10 Σκουριά / Rust

BT9013WG MR16 Λευκό / White

BT9013AG MR16 Γκρι / Grey

BT9013BG MR16 Μαύρο / Black

BT9014G GU10 Γκρι / Grey

HI7182NGR Γκρι πασσαλάκι / Grey stake

HI7182NBL Μαύρο πασσαλάκι / Black stake

- Χυτό αλουμίνιο / Die-casting aluminum.
- Πυρίμαχο γυαλί / Fire resistant glass.

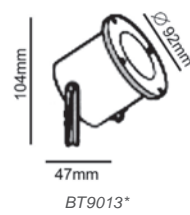

BT9013*

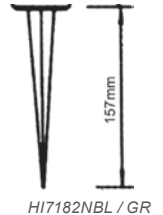

HI7182NBL / GR

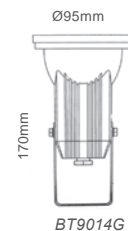

BT9014G

Τα τεχνικά στοιχεία του προϊόντος (Χρώμα-Διάσταση) ενδέχεται να διαφέρουν από τα αναγραφόμενα με μια απόκλιση +/- 10%
The technical data (Color-Dimension) of the product may differ from the listed +/- 10%

*Υπό κατάργηση / Under abolition

www.acalight.gr

Πλαστικά σποτ GU10 / GU10 plastic spot luminaires

IP65



230V | GU10 max. 3W LED ΓΕΝ. ΣΥΣΚΕΥΑΣΙΑ
MASTER PACKING

SL7030W Λευκό / White	20
SL7030B Μαύρο / Black	20
SL7030G Γκρι / Grey	20
SL7030R Σκουριά / Rust	20

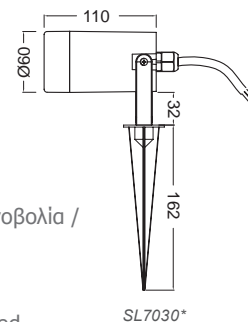

- Πλαστικό ενισχυμένο σώμα με ειδική προστασία ενάντια στη UV ακτινοβολία / Reinforced plastic body with special protection towards UV radiation.
- Πλαστικό διάφανο κάλυμμα / Plastic transparent cover.
- Στεγανός στυπιοθλιπτής / Waterproof stuffing tube.
- Συμπεριλαμβάνεται πλαστικό πασαλάκι / Garden plastic spike is included.
- Καλώδιο παροχής ρεύματος 30cm / Power supply cable 30cm.



2 Δέσμεων / 2 Beams
230V | 2 x GU10 max. 3W ΓΕΝ. ΣΥΣΚΕΥΑΣΙΑ
MASTER PACKING

SL7031W Λευκό / White	16
SL7031B Μαύρο / Black	16
SL7031G Γκρι / Grey	16
SL7031R Σκουριά / Rust	16

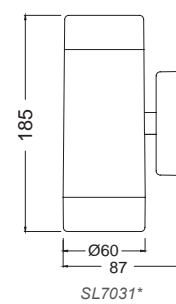

1 Δέσμης / 1 Beam
230V | GU10 max. 3W LED ΓΕΝ. ΣΥΣΚΕΥΑΣΙΑ
MASTER PACKING

SL7032W Λευκό / White	16
SL7032B Μαύρο / Black	16
SL7032G Γκρι / Grey	16
SL7032R Σκουριά / Rust	16

- Πλαστικό ενισχυμένο σώμα με ειδική προστασία στη UV ακτινοβολία του ήλιου / Reinforced plastic body with special protection towards sun UV radiation.
- Πλαστικό διάφανο κάλυμμα / Plastic transparent cover.
- Φλάντζα στεγανοποίησης / Waterproof flange.
- Λεπτός σχεδιασμός / Slim design.

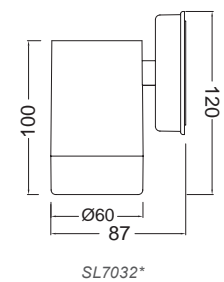

Με αισθητήρα ημέρας-νύχτας και κίνησης
With day-night and motion sensor
1 Δέσμης / 1 Beam
230V | GU10 max. 3W LED ΓΕΝ. ΣΥΣΚΕΥΑΣΙΑ
MASTER PACKING

SL7032WS Λευκό / White	16
SL7032BS Μαύρο / Black	16
SL7032GS Γκρι / Grey	16
SL7032RS Σκουριά / Rust	16

- Πλαστικό ενισχυμένο σώμα με ειδική προστασία ενάντια στη UV ακτινοβολία / Reinforced plastic body with special protection towards UV radiation.
- Πλαστικό διάφανο κάλυμμα / Plastic transparent cover.
- Φλάντζα στεγανοποίησης / Waterproof flange.
- Αυτόματη λειτουργία ημέρας-νύχτας / Day - night auto function.
- Ρυθμιζόμενος χρόνος λειτουργίας / Adjustable working time (10sec - 4min).
- 8 μέτρα μέγιστη εμβέλεια ανίχνευσης / 8 meters max detection range.
- 90° μέγιστη γωνία ανίχνευσης / 90° max detection angle.

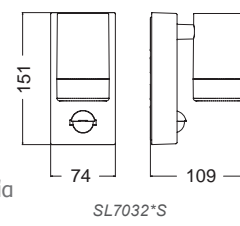

**ΣΕ ΠΑΡΑΓΓΕΛΙΑ ΓΕΝ. ΣΥΣΚΕΥΑΣΙΑΣ ΕΠΙΠΛΕΟΝ ΕΚΠΤΩΣΗ 5%
FOR MASTER PACKING ORDER EXTRA DISCOUNT 5%**

Ιδανικό για εγκατάσταση δίπλα στη θάλασσα / Ideal for installation nearby the sea



Σημείωση: Ο λαμπτήρας LED GU10 που θα εγκατασταθεί πρέπει να είναι ονομαστικής ισχύς max. 3W και δεν συμπεριλαμβάνεται
Notice: The maximum wattage of the GU10 LED lamp that is going to be installed inside is 3W and is not included.

Τα τεχνικά στοιχεία του προϊόντος (Χρώμα-Διάσταση) ενδέχεται να διαφέρουν από τα αναγραφόμενα με μια απόκλιση +/- 10%
The technical data (Color-Dimension) of the product may differ from the listed +/- 10%

Απλικές εξωτερικών χώρων αλουμινίου / Outdoor wall aluminum luminaires

IP54



HI7031W



HI7031B



HI7031G



HI7031R

2 Δέσμεων / 2 Beams
230V | 2xGU10 max. 35W

HI7031W Λευκό / White 2 x GU10

HI7031B Μαύρο / Black 2 x GU10

HI7031G Γκρι / Grey 2 x GU10

HI7031R Σκουριά / Rust 2 x GU10

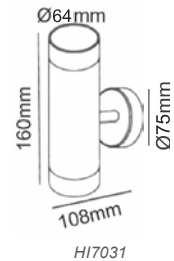

HI7031



HI7032AW



HI7032AB



HI7032AG



HI7032AR

1 Δέσμης / 1 Beam
230V | GU10 max. 35W

HI7032AW Λευκό / White 1 x GU10

HI7032AB Μαύρο / Black 1 x GU10

HI7032AG Γκρι / Grey 1 x GU10

HI7032AR Σκουριά / Rust 1 x GU10

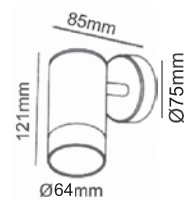

HI7032



HI7033AW



HI7033AB



HI7033AR

1 Δέσμης / 1 Beam
Ανακλιόμενος & περιστρεφόμενος βραχίονας /
Reclinating & rotating arm
230V | GU10 max. 35W

HI7033AW Λευκό / White 1 x GU10

HI7033AB Μαύρο / Black 1 x GU10

HI7033AR Σκουριά / Rust 1 x GU10



HI7033



HI7001W



HI7001B



HI7001R



HI7001B

2 Δέσμεων / 2 Beams
230V | 2xE27 max. 60W

HI7001W Λευκό / White 2 x E27

HI7001B Μαύρο / Black 2 x E27

HI7001 Γκρι / Grey 2 x E27

HI7001R Σκουριά / Rust 2 x E27

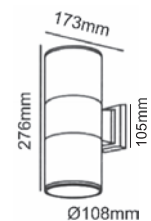

HI7001

1 Δέσμης / 1 Beam
230V | E27 max. 60W

HI7002W Λευκό / White 1 x E27

HI7002B Μαύρο / Black 1 x E27

HI7002 Γκρι / Grey 1 x E27

HI7002R Σκουριά / Rust 1 x E27



HI7002W



HI7002



HI7002R



HI7002B

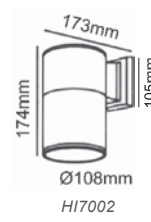

HI7002

- Χυτό αλουμίνιο / Die-casting aluminum
- Πυρίμαχο γυαλί / Fire resistant glass



ΛΕΥΚΟ
WHITE



ΜΑΥΡΟ
BLACK



ΓΚΡΙ
GREY



ΣΚΟΥΡΙΑ
RUST

Τα τεχνικά στοιχεία του προϊόντος (Χρώμα-Διάσταση) ενδέχεται να διαφέρουν από τα αναγραφόμενα με μια απόκλιση +/- 10%
The technical data (Color-Dimension) of the product may differ from the listed +/- 10%

Απλίκες - σποτ εξωτερικών χώρων / Outdoor wall - spot luminaires



HI7061/M

HI7033A

230V | GU10 max. 35W
12V | GU5.3 MR16 max. 35W

HI7061 GU10 IP65

HI7061M GU5.3 MR16 IP54

HI7033A GU10 Inox IP54

HI7032A GU10 Nickel matt IP54

HI7032AL GU10 Bronze IP54

HI7031A 2 x GU10 Inox IP54

HI7031AM 2 x GU5.3 MR16 Inox IP54

- Ανοξειδωτο σσάλι / Stainless steel
- Πυρίμαχο γυαλί / Fire resistant glass



HI7031A



HI7031AM



HI7032AL



HI7032A

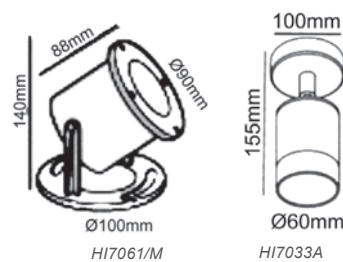

HI7061/M

HI7033A

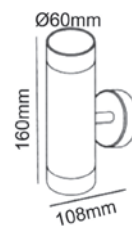

HI7031A
HI7031AM



HI7032AL

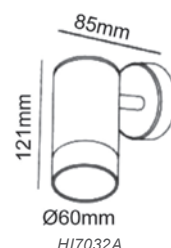

HI7032A

Απλίκες 2 δέσμεων αλουμινίου / Wall aluminum up-down beam luminaires

IP54



HI7355

HI7031AL

230V | 2 x GU10 max. 35W

HI7355 Νικελ ματ / Nickel matt

HI7031AL Μπρονζέ / Bronze

- Χυτό αλουμίνιο / Die-casting aluminum
- Πυρίμαχο γυαλί / Fire resistant glass
- Ντουί / Lampholder GU10

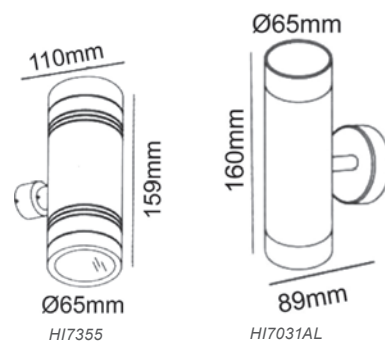

HI7355

HI7031AL

Απλίκες - σποτ εξωτερικών χώρων / Outdoor wall - spot luminaires

IP65



HI7072

HI7172

230V | GU10 max. 35W

HI7072 GU10

HI7071 GU10

12V | GU5.3 MR16 max. 35W

HI7172 GU5.3 / MR16

HI7171 GU5.3 / MR16

- Χυτό αλουμίνιο / Die-casting aluminum
- Πυρίμαχο γυαλί / Fire resistant glass



HI7171



HI7071

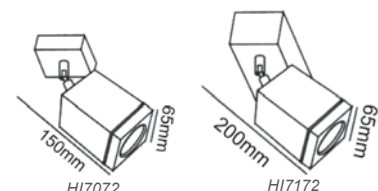

HI7072

HI7172

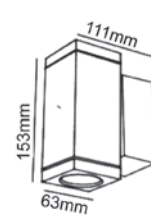

HI7171

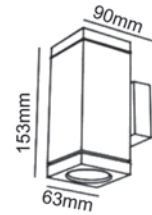

HI7071

Τα τεχνικά στοιχεία του προϊόντος (Χρώμα-Διάσταση) ενδέχεται να διαφέρουν από τα αναγραφόμενα με μια απόκλιση +/- 10%

The technical data (Color-Dimension) of the product may differ from the listed +/- 10%

Απλίκες - σποτ αλουμινίου εξωτερικών χώρων / Outdoor aluminum wall - spot luminaires

IP54



230V | GU10 max. 35W

HI7361

HI7362

HI7363

- Χυτό αλουμίνιο / Die-casting aluminum.
- Πυρίμαχο γυαλί / Fire resistant glass.
- Ντουί / Lampholder GU10.

ΓΚΡΙ
GREY

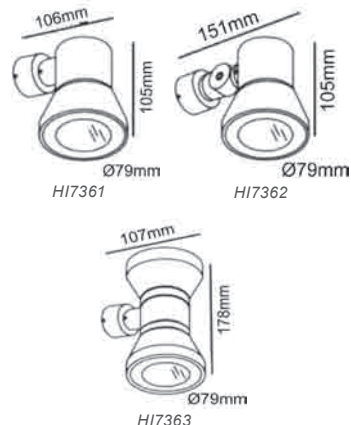

Απλίκες - σποτ αρχιτεκτονικού φωτισμού / Architectural wall - spot luminaires

IP54



HI7232A

INOX

4 Δέσμειων / Beams

2 Κλειστές & 2 Ανοιχτές / 2 Narrow & 2 Wide

230V | G9 max. 40W

*HI7232A

- Ανοξείδωτο ατσάλι / Stainless steel.
- Πυρίμαχο γυαλί / Fire resistant glass.
- Ντουί / Lampholder G9.

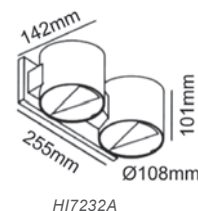

HI7232A

Σποτ δέσμειων αρχιτεκτονικού φωτισμού / Architectural lighting beam spot luminaire

IP54



HI4111

HI4113

230V | G9 max. 40W

*HI4111 2 Δέσμειων / Beams

*HI4113 4 πολλαπλών δέσμειων / 4 Multi Beams

- Χυτό αλουμίνιο / Die-casting aluminum.
- Πρισματικό γυαλί / Frost glass.
- Ντουί / Lampholder G9.

ΓΚΡΙ
GREY

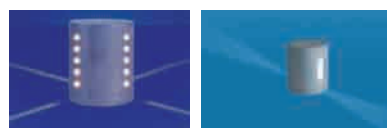

Απλίκες - σποτ εξωτερικών χώρων / Outdoor wall - spot luminaire



HI4101
HI4102

XFWL80B

XFWL80D

XFWL80C

230V | E27 max. 40W

*HI4101 2 Δέσμειων / Beams

(1 κλειστή -1 ανοιχτή)

*HI4102 2 Δέσμειων / Beams (2 ανοιχτές)

Κενό / Empty

*XFWL80D 2 Δέσμειων / Beams

*XFWL80C 1 Δέσμης / Beam

*XFWL80B Κινητό / Movable

- Χυτό αλουμίνιο / Die-casting aluminum.
- Πυρίμαχο γυαλί / Fire resistant glass.

ΓΚΡΙ
GREY

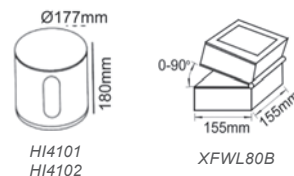

HI4101
HI4102

XFWL80B

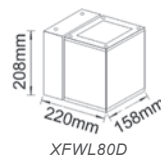

XFWL80D

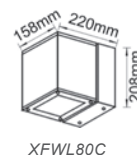

XFWL80C

Χωνευτό σποτ δαπέδου / Underground spot luminaire

IP66



HI7372/M

230V | GU10 max. 35W

HI7371

HI7372

12V | GU5.3 MR16 max. 35W

HI7371M

HI7372M

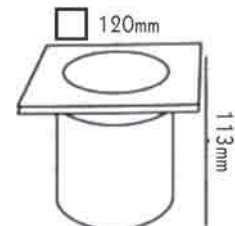

HI7372/M



HI7333



HI7331

230V | GU10 max. 35W

12V | GU5.3 MR16 max. 35W

HI7331 Νίκελ ματ / Nickel matt

HI7333 Νίκελ ματ / Nickel matt

HI7373 Νίκελ ματ με στρογγυλο ή τετράγωνο γυαλί / Nickel matt with round or square glass



HI7331
HI7333

- Κάλυμμα απο ανοξείδωτο αστάλι / Stainless steel cover.
- Σώμα απο χυτό αλουμίνιο / Die-casting aluminum body.
- Ανοξείδωτες βίδες / Stainless steel screws.

INOX



HI7371/M

HI7373



HI7371/M

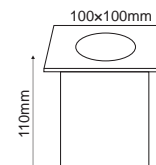

Στρογγυλο γυαλί
Round glass

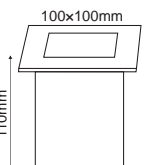

Τετράγωνο γυαλί
Square glass

HI7373

Σποτ δαπέδου / Floor spot luminaire



12V | GU5.3 MR16 max.50W
ΚΙΝΗΤΟΣ - MOVABLE

*AC.045XFFL2

- Ανοδιωμένο αλουμίνιο / Anodized aluminum
- Πυρίμαχο γυαλί / Fire resistant glass
- Ντουί / Lampholder GU5.3 MR16.
- Ανοξείδωτες βίδες / Stainless steel screws.

ΓΚΡΙ
GREY

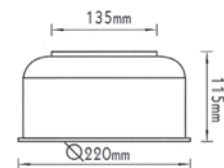

Φωτιστικό χωνευτό ΗQI δαπέδου / Floor recessed HQI luminaire

IP66



ΓΚΡΙ
GREY

RX7S / E27 / G12 / AR111 / LED MODULE

FYZW626I Κενό φωτιστικό / Empty Lighting

PB626 Πλαστικό κουτί τοποθέτησης / Plastic mounting box

- Κάλυμμα απο ανοξείδωτο αστάλι / Stainless steel cover.
- Σώμα απο χυτό αλουμίνιο / Die-casting aluminum body.
- Πυρίμαχο διαφανές γυαλί / Fire resistant transparent glass.
- Αντοχή στατικού βάρους 500Kg / Resistance static 500Kg.
- Ανοξείδωτες βίδες / Stainless steel screws.
- Δυνατότητα κινητής βάσης ντουί - LED module / Ability of movable lampholder base - LED module.

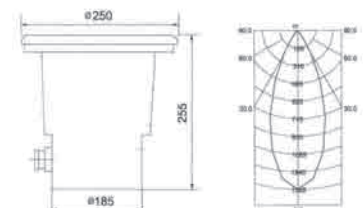

Φωτιστικό για λαμπτήρα LED T8 230V AC / Luminaire for T8 LED LAMP 230V AC DELED



Παροχή σύνδεσης στο κέντρο του φωτιστικού
Power supply at the middle of the lighting

- Σώμα από ατσάλι / Steel body.
- Εύκολη και γρήγορη τοποθέτηση / Fast and easy installation.
- Δεν δέχεται ανταυγαστήρα / Doesn't accept reflector.
- Ντουί / Lampholder T8 G13 lamp.

Φωτιστικό για ένα λαμπτήρα T8 G13.
Luminaire for one T8 G13 lamp.

ΓΕΝ. ΣΥΣΚΕΥΑΣΙΑ
 MASTER PACKING

*DELED60 600 x 34 x 15mm	1/60
*DELED90 900 x 34 x 15mm	1/60



Λεπτός σχεδιασμός!!!
Slim Design!!!



Παροχή σύνδεσης στο άκρο του φωτιστικού
Power supply at the end of the lighting

- Σώμα από φύλλο αλουμινίου / Aluminum sheet body.
- Ιδανικό για γραμμικό φωτισμό χωρίς σκιάσεις / Ideal for linear lighting without shadows.
- Δεν δέχεται ανταυγαστήρα / Doesn't accept reflector.
- Ντουί / Lampholder T8 G13 lamp.
- 200W μέγιστη ισχύς από μία παροχή ρεύματος / Max. 200W from one power supply.

Διασυνδεόμενο φωτιστικό για ένα λαμπτήρα T8 G13.
Linkable luminaire for one T8 G13 lamp.

ΓΕΝ. ΣΥΣΚΕΥΑΣΙΑ
 MASTER PACKING

DELED60L 600 x 34 x 15mm	1/60
DELED90L 900 x 34 x 15mm	1/60
DELED120L 1200 x 34 x 15mm	1/60
DELED150L 1500 x 34 x 15mm	1/60



Παροχή σύνδεσης στο κέντρο του φωτιστικού
Power supply at the middle of the lighting

- Σώμα από ατσάλι / Steel body.
- Εύκολη και γρήγορη τοποθέτηση / Fast and easy installation.
- Ντουί / Lampholder T8 G13 lamp.

Φωτιστικό για ένα λαμπτήρα T8 G13 με δυνατότητα τοποθέτησης ανταυγαστήρα.
Luminaire for one T8 G13 lamp with reflector installation ability.

ΓΕΝ. ΣΥΣΚΕΥΑΣΙΑ
 MASTER PACKING

DELED60M 600 x 34 x 15mm	1/60
DELED90M 900 x 34 x 15mm	1/60
DELED120M 1200 x 34 x 15mm	1/60
DELED150M 1500 x 34 x 15mm	1/60

Φωτιστικό για δύο λαμπτήρες T8 G13 με δυνατότητα τοποθέτησης ανταυγαστήρα.
Luminaire for two T8 G13 lamp with reflector installation ability.

ΓΕΝ. ΣΥΣΚΕΥΑΣΙΑ
 MASTER PACKING

DELED260M 600 x 34 x 15mm	1/60
DELED290M 900 x 34 x 15mm	1/60
DELED2120M 1200 x 34 x 15mm	1/60
DELED2150M 1500 x 34 x 15mm	1/60



ΛΕΥΚΟ
 WHITE

Ανταυγαστήρας αλουμινίου για φωτιστικό μονού λαμπτήρα T8 G13 DELEDM.**
Aluminum reflector for single lamp T8 G13 luminaire DELEDM.**

ΓΕΝ. ΣΥΣΚΕΥΑΣΙΑ
 MASTER PACKING

FLER60 600mm	1/60
FLER90 900mm	1/60
FLER120 1200mm	1/40

Ανταυγαστήρας αλουμινίου για φωτιστικό διπλού λαμπτήρα T8 G13 DELED2M.**
Aluminum reflector for double lamp T8 G13 luminaire DELED2M.**

ΓΕΝ. ΣΥΣΚΕΥΑΣΙΑ
 MASTER PACKING

FLER260 600mm	1/60
FLER290 900mm	1/50
FLER2120 1200mm	1/40

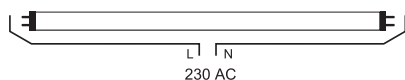

ΠΡΟΣΟΧΗ / ATTENTION

Η σειρά φωτιστικών DELED δέχεται αποκλειστικά λαμπτήρα LED T8 "Diolamp"
 DELED luminaires accepts only LED lamp T8 "Diolamp"

ΣΕ ΠΑΡΑΓΓΕΛΙΑ ΓΕΝ. ΣΥΣΚΕΥΑΣΙΑΣ ΕΠΙΠΛΕΟΝ ΕΚΠΤΩΣΗ 5%
FOR MASTER PACKING ORDER EXTRA DISCOUNT 5%

Σκαφάκι απλό Α' ποιότητας / High quality luminaire T8 DELTA



DELTA2X18

Σκαφάκια για λαμπτήρες LED
Light fitting for LED lamps

TH3118LED 1x600mm

TH31218LED 2x600mm

TH3136LED 1x1200mm

TH3236LED 2x1200mm

TH3158LED 1x1500mm

TH3258LED 2x1500mm

Με ηλεκτρονικό μετασχηματιστή
With electronic ballast

DELTA1X18L 1x18W

DELTA2X18L 2x18W

DELTA1X36L 1x36W

DELTA2X36L 2x36W

DELTA1X58L 1x58W

DELTA2X58L 2x58W

Με μαγνητικό μετασχηματιστή B2 χωρίς πυκνωτή
With magnetic ballast B2 without capacitor

DELTA1X18 1x18W

DELTA2X18 2x18W

DELTA1X36 1x36W

DELTA2X36 2x36W

DELTA1X58 1x58W

DELTA2X58 2x58W

- Σώμα από αστάλι / Steel body.
- Λευκή ηλεκτροστατική βαφή / White electrostatic paint.
- Ντουί / Lampholder G13 T8.

Σκαφάκι κενό με δυνατότητα τοποθέτησης ανταυγαστήρα /
Empty luminaire with reflector installation ability T8



DEL2X18

Κενό χωρίς ανταυγαστήρα
Empty without reflector

*DEL1X18 1x18W

*DEL2X18 2x18W

*DEL1X36 1x36W

*DEL2X36 2x36W

*DEL1X58 1x58W

*DEL2X58 2x58W

Ανταυγαστήρας καθρέπτης αλουμινίου
Aluminum mirror reflector

*T8118RE Για / For 1x18W

*T8218RE Για / For 2x18W

*T8136RE Για / For 1x36W

*T8236RE Για / For 2x36W

*T8158RE Για / For 1x58W

*T8258RE Για / For 2x58W

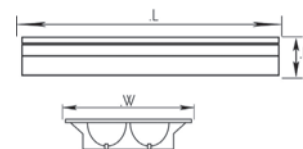

L W H

DEL1X18 620 x 50 x 33mm

DEL2X18 620 x 100 x 33mm

DEL1X36 1230 x 50 x 33mm

DEL2X36 1230 x 100 x 33mm

DEL1X58 1530 x 50 x 33mm

DEL2X58 1530 x 100 x 33mm

- Σώμα από αστάλι / Steel body.
- Λευκή ηλεκτροστατική βαφή / White electrostatic paint.
- Ανταυγαστήρας - καθρέπτης αλουμινίου (προαιρετικά) / Aluminum reflector-mirror (optional).
- Ντουί / Lampholder G13 T8.



Για διαφορετικά watt με οποιαδήποτε μπάλαστ, επικοινωνήστε μαζί μας
For different watt with any ballast, contact us

Σκαφάκι απλό Α' ποιότητας / High quality luminaire T5



T5228E

Με ηλεκτρονικό μετασχηματιστή
With electronic ballast

*T5114E 1x14W

*T5128E 1x28W

*Q5135E 1x35W

*T5214E 2x14W

*T5228E 2x28W

*Q5235E 2x35W

Ανταυγαστήρας αλουμινίου για σκαφάκι T5
Aluminium reflector for light fitting T5

*T5114RE Για / For 1x14W

*T5214RE Για / For 2x14W

*T5128RE Για / For 1x28W

*T5228RE Για / For 2x28W

*T5135RE Για / For 1x35W

*T5235RE Για / For 2x35W

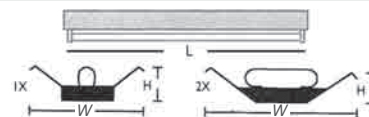

L W H

T5114E 580 x 38 x 20mm

T5128E 1180 x 38 x 20mm

Q5135E 1480 x 50 x 39mm

T5214E 580 x 38 x 20mm

T5228E 1180 x 38 x 20mm

Q5235E 1480 x 50 x 34mm

- Σώμα από αστάλι / Steel body.
- Λευκή ηλεκτροστατική βαφή / White electrostatic paint.
- Ντουί / Lampholder G5 T5.



Για διαφορετικά watt, επικοινωνήστε μαζί μας
For different watt, contact us

Όλα τα Φ/Σ T8 & T5 διατίθενται και με dimmable ballast, συστήματα επεδρικού φωτισμού κ.τ.λ.
All the fluorescent luminaires T8 & T5 are available with dimmable ballast, emergency systems e.t.c

*Υπό κατάργηση / Under abolition

Στεγανά φωτιστικά / Waterproof luminaires T8

IP65

Φωτιστικά για λαμπτήρες LED
Luminaires for LED lamps

AC.7118LED 1x600mm

AC.7136LED 1x1200mm

AC.7158LED 1x1500mm

AC.7218LED 2x600mm

AC.7236LED 2x1200mm

AC.7258LED 2x1500mm

AC.7SSC Μεταλλικό κλιπ /
Metallic clip

AC.7HOOKS Ανάρτηση /
Suspension

Κενά / Empty

AC.7118PCE 1x18W

AC.7218PCE 2x18W

AC.7136PCE 1x36W

AC.7236PCE 2x36W

AC.7158PCE 1x58W

AC.7258PCE 2x58W

Με ηλεκτρονικό μετασχηματιστή
With electronic ballast

AC.7118PCE 1x18W

AC.7218PCE 2x18W

AC.7136PCE 1x36W

AC.7236PCE 2x36W

AC.7158PCE 1x58W

AC.7258PCE 2x58W

AC.7SEC Μεταλ. ανοξείδωτα
κλιπ / Stainless metallic clips

Φωτιστικά για λαμπτήρες LED
Luminaires for LED lamps

AC.3118H 1x600mm

AC.3136H 1x1200mm

AC.3158H 1x1500mm

AC.3218H 2x600mm

AC.3236H 2x1200mm

AC.3258H 2x1500mm

Με μαγνητικό μετασχηματιστή B2 χωρίς πυκνωτή
With magnetic ballast B2 without capacitor

AC.7118FBB 1x18W

AC.7136FBB 1x36W

AC.7158FBB 1x58W

AC.7218FBB 2x18W

AC.7236FBB 2x36W

- Σώμα & κλιπ από ABS / ABS body & clip.
- Μεταλλικός καθρέπτης / Metal mirror.
- Κάλυμμα από PS / PS cover.
- Ντουί / Lampholder G13 T8.



A B C A B C

AC.7118PCE 650 x 72 x 86

AC.7218PCE 650 x 115 x 86

AC.7136PCE 1265 x 72 x 86

AC.7236PCE 1265 x 115 x 86

AC.7158PCE 1565 x 72 x 86

AC.7258PCE 1565 x 115 x 86

- Σώμα, κλιπ και κάλυμμα από PC πολυκαρμπονάτ / Body, clip and cover from polycarbonate PC.
- Μεταλλικός καθρέπτης / Metal mirror.
- Συμπεριλαμβάνονται ανοξείδωτες βάσεις εγκατάστασης / stainless bases for installation are included.
- Ντουί / Lampholder G13 T8.



A B C A B C

AC.3118H 680 x 70 x 63

AC.3218H 660 x 112 x 63

AC.3136H 1280 x 70 x 63

AC.3236H 1260 x 112 x 63

AC.3158H 1580 x 70 x 63

AC.3258H 1560 x 112 x 63

- Σώμα από ABS / ABS body
- Κάλυμμα από PS / PS cover.
- Μεταλλικά κλιπ / Metal clip.
- Μεταλλικός καθρέπτης / Metal mirror.
- Συμπεριλαμβάνονται ανοξείδωτες βάσεις εγκατάστασης / stainless bases for installation are included.
- Ντουί / Lampholder G13 T8.

Στεγανά πολυκαρβονικά φωτιστικά / Waterproof polycarbonate luminaires T5

IP65

Με ηλεκτρονικό μετασχηματιστή
With electronic ballast

AC.7114 1x14W

AC.7214 2x14W

AC.7128 1x28W

AC.7228 2x28W

AC.7135 1x35W

AC.7235 2x35W

- Σώμα, κλιπ και κάλυμμα από PC πολυκαρμπονάτ / Body, clip and cover from polycarbonate PC.
- Μεταλλικός καθρέπτης / Metal mirror.
- Ντουί / Lampholder G5 T5.



Για διαφορετικά watt με οποιαδήποτε μπάλαστ, επικοινωνήστε μαζί μας
For different watt with any ballast, contact us



A B C

AC.7114 615 x 65 x 50mm

AC.7214 615 x 100 x 50mm

AC.7128 1215 x 65 x 50mm

AC.7228 1215 x 100 x 50mm

AC.7135 1515 x 65 x 50mm

AC.7235 1515 x 100 x 50mm

Όλα τα Φ/Σ T8 & T5 διατίθενται και με dimmable ballast, συστήματα επεδρικού φωτισμού κ.τ.λ.
All the fluorescent luminaires T8 & T5 are available with dimmable ballast, emergency systems e.t.c

Φωτιστικά οροφής / Ceiling luminaires T8



AC.F5236

Με μαγνητικό μετασχηματιστή B2 starter & πυκνωτή
With magnetic ballast B2 starter & capacitor

*AC.F5118 1x18W

*AC.F5136 1x36W

*AC.F5236 2x36W

*AC.F5418 4x18W

Με ηλεκτρονικό μετασχηματιστή
With electronic ballast

*AC.F5218L 2x18W

*AC.F5136L 1x36W

*AC.F5236L 2x36W

*AC.F5258L 2x58W

*AC.F5418L 4x18W

*AC.F5436L 4x36W

Φωτιστικά κενά
Empty luminaires

AC.5136FCE 1x1200mm

AC.5236FCE 2x1200mm

AC.5258FCC 2x1500mm

AC.5418FCE 4x600mm



AC.5236FCE

Με μαγνητικό μετασχηματιστή B2 starter & πυκνωτή
With magnetic ballast B2 starter & capacitor

AC.5118FC 1x18W

AC.5218FC 2x18W

AC.5136FC 1x36W

AC.5236FC 2x36W

AC.5258FC 2x58W

AC.5418FC 4x18W

AC.5436FC 4x36W

Με ηλεκτρονικό ballast
With electronic ballast

AC.5118FCL 1x18W

AC.5218FCL 2x18W

AC.5136FCL 1x36W

AC.5236FCL 2x36W

AC.5258FCL 2x58W

AC.5418FCL 4x18W

AC.5436FCL 4x36W

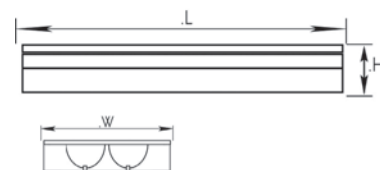

	L	W	H
AC.F5118	610	300	65mm
AC.F5218L	610	300	65mm
AC.F5136/L	1220	300	65mm
AC.F5236/L	1220	300	65mm
AC.F5418/L	610	600	65mm
AC.F5436/L	1220	600	65mm

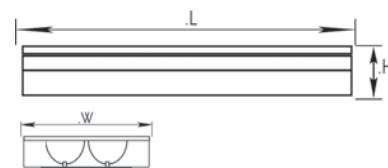

	L	W	H
AC.F5118FC/FCL	610	185	70mm
AC.F5218FC/FCL	610	300	70mm
AC.F5136FC/FCL	1220	185	70mm
AC.F5236FC/FCL	1220	300	70mm
AC.F5258FC/FCL	1520	300	70mm
AC.F5418FC/FCL	610	600	70mm
AC.F5436FC/FCL	1220	600	70mm

- Σώμα από ατσάλι / Steel body.
- Λευκή ηλεκτροστατική βαφή / White electrostatic paint.
- Διπλό παραβολικό απο ανοδιωμένο αλουμίνιο / Anodized aluminum double parabolic.
- Ντουί / Lampholder G13 T8.

Φωτιστικό ψευδοροφής T8 / Recessed T8 luminaire

Φωτιστικά κενά
Empty luminaires

AC.51418FE 4x600mm

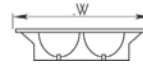

L W H

AC.5118FHL 600 x 180 x 85mm

AC.5218FHL 600 x 300 x 80mm

AC.5136FHL 1200 x 180 x 85mm

AC.5236FHL 1200 x 300 x 80mm

AC.5258FHL 1500 x 300 x 80mm

AC.5418FHL 600 x 600 x 80mm

AC.5436FHL 1200 x 600 x 80mm

Με μαγνητικό μετασχηματιστή B2 starter & πυκνωτή
With magnetic ballast B2 starter & capacitor

AC.5118FH 1x18W

AC.5218FH 2x18W

AC.5136FH 1x36W

AC.5236FH 2x36W

AC.5258FH 2x58W

AC.5418FH 4x18W

Με ηλεκτρονικό μετασχηματιστή
With electronic ballast

AC.5118FHL 1x18W

AC.5218FHL 2x18W

AC.5136FHL 1x36W

AC.5236FHL 2x36W

AC.5258FHL 2x58W

AC.5418FHL 4x18W

AC.5436FHL 4x36W

*AC.5455FH 4x55W

*AC.5236FCCL 2x36W
εμμέσου φωτισμού 60 x 60cm

- Σώμα από αστάλι / Steel body.
- Λευκή ηλεκτροστατική βαφή / White electrostatic paint.
- Διπλό παραβολικό από ανοδιωμένο αλουμίνιο / Anodized aluminum double parabolic.
- Ντουί / Lampholder G13 T8.



AC.5455FH



AC.5218FHL



AC.5236FCCL



*Υπάρχει η δυνατότητα τοποθέτησης διαφορετικών watt & μπάλαστ
Ability to place different watt & ballast

Καλύμματα & εξαρτήματα για φωτιστικά ψευδοροφής / Covers & accessories for recessed luminaires



AC.5418FP



AC.5418FM



AC.54C

AC.5418FP Κρυσταλιζέ κάλυμμα / Crystalize cover
600 x 600mm

AC.5418FM Γαλακτερό κάλυμμα / Opal cover
600 x 600mm

AC.5418FR Περσίδα σκέτη για / Shutter for 4x18W

AC.54C Κλιπ ψευδ/φής για στήριξη σε γυψοσανίδα /
False ceiling clip for gypsum board support

Πολυκαρβονική κενή πλαφονιέρα / Polycarbonate empty ceiling luminaire

IP65



SPKF43 Κενό / Empty



Δυνατότητα τοποθέτησης κυκλικών λαμπτήρων T9, E27 ντουϊ ή πλακέτας LED.
Possibility to place circular lamps T9, E27 lampholder or LED module

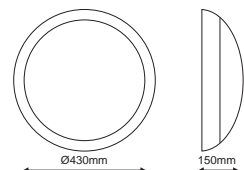

Όλα τα Φ/Σ T8 & T5 διατίθενται και με dimmable ballast, συστήματα εφεδρικού φωτισμού κ.τ.λ.
All the fluorescent luminaires T8 & T5 are available with dimmable ballast, emergency systems e.t.c

Φωτιστικά ψευδοροφής / Recessed luminaires T5



Για διαφορετικά watt, επικοινωνήστε μαζί μας
For different watt, contact us

Με ηλεκτρονικό μετασχηματιστή
With electronic ballast

- AC.5114FH 1x14W
- AC.5214FH 2x14W
- AC.5314FH 3x14W
- AC.5414FH 4x14W
- AC.5324FH 3x24W
- AC.5424FH 4x24W
- AC.5128FH 1x28W
- AC.5228FH 2x28W

- Σώμα από ατσάλι / Steel body.
- Λευκή ηλεκτροστατική βαφή / White electrostatic paint.
- Διπλό παραβολικό απο ανοδιωμένο αλουμίνιο / Anodized aluminum double parabolic.
- Ντουί / Lampholder G5 T5.

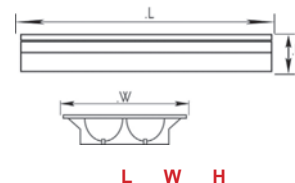

- AC.5114FH 600 x 210 x 60mm
- AC.5214FH 600 x 300 x 60mm
- AC.5414FH 600 x 600 x 60mm
- AC.5128FH 1200 x 210 x 60mm
- AC.5228FH 1200 x 300 x 60mm

Φωτιστικά οροφής / Ceiling luminaires T5



Για διαφορετικά watt, επικοινωνήστε μαζί μας
For different watt, contact us

Με ηλεκτρονικό μετασχηματιστή
With electronic ballast

- AC.5114FC 1x14W
- AC.5214FC 2x14W
- AC.5414FC 4x14W
- AC.5128FC 1x28W
- AC.5228FC 2x28W
- AC.5428FC 4x28W
- AC.5135FC 1x35W
- AC.5235FC 2x35W
- AC.5249FC 2x49W

- Σώμα από ατσάλι / Steel body.
- Λευκή ηλεκτροστατική βαφή / White electrostatic paint.
- Διπλό παραβολικό απο ανοδιωμένο αλουμίνιο / Anodized aluminum double parabolic.
- Ντουί / Lampholder G5 T5.

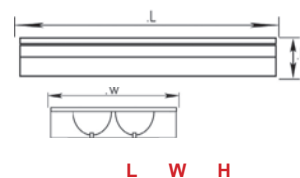

- AC.5114FC 572 x 210 x 70mm
- AC.5214FC 572 x 300 x 70mm
- AC.5414FC 572 x 600 x 70mm
- AC.5128FC 1173 x 210 x 70mm
- AC.5228FC 1173 x 300 x 70mm
- AC.5428FC 1173 x 600 x 70mm

Γραμμικά φωτιστικά ψευδοροφής / Linear recessed luminaires T5



AC.5214WE



AC.5214OE



TL114D



TL114O



Δυνατότητα κατόπιν ενδιαφέροντος, οποιασδήποτε κατασκευής φωτιστικών από προφίλ αλουμινίου σε T5 ή LED / Construct under demand any aluminum profile into T5 or LED luminaire

Στις παρακάτω τιμές δεν συμπεριλαμβάνεται μετασχηματιστής / Below prices do not include ballast

Με περσίδα / With louver

- *AC.5214WE 2x14-24W
- *AC.5228WE 2x28-54W
- *TL114D 14-24W
- *TL128D 28-54W
- *TL135D 35-49-80W

Με γαλακτερό κάλυμμα / With opal cover

- *AC.5214OE 2x14-24W
- *AC.5228OE 2x28-54W
- *TL114O 14-24W
- *TL128O 28-54W
- *TL135O 35-49-80W

Σετ χωνευτής εγκατάστασης (Σειρά TL*)
Recessed installation set (TL* Series)

- *STKN

- Σώμα από ατσάλι / Steel body.
- Λευκή ηλεκτροστατική βαφή / White electrostatic paint.
- Διπλό παραβολικό απο ανοδιωμένου αλουμινίου ή οπάλ κάλυμμα / Anodized aluminum double parabolic or opal cover.

Όλα τα Φ/Σ T8 & T5 διατίθενται και με dimmable ballast, συστήματα εφεδρικού φωτισμού κ.τ.λ.
All the fluorescent luminaires T8 & T5 are available with dimmable ballast, emergency systems e.t.c

*Υπό κατάργηση / Under abolition

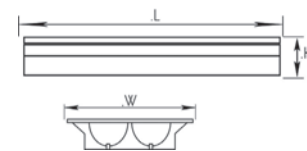

- AC.5214WE 595 x 144 x 80mm
- AC.5214OE 595 x 144 x 80mm
- AC.5228WE 1200 x 144 x 80mm
- AC.5228OE 1200 x 144 x 80mm



- TL114D 595 x 75 x 105mm
- TL128D 1195 x 75 x 105mm
- TL135D 1490 x 75 x 105mm
- TL114O 595 x 75 x 105mm
- TL128O 1195 x 75 x 105mm
- TL135O 1490 x 75 x 105mm

Γραμμικά κρεμαστά φωτιστικά / Linear pendant luminaires T5 ASPET

SPT51X21



SPT52X21



SPT51X28

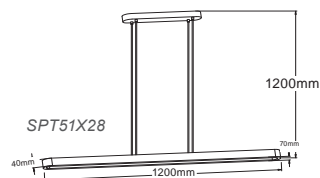
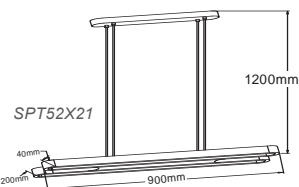
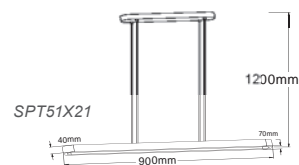

*SPT51X21 1x21W T5 900mm

*SPT51X28 1x28W T5 1200mm

*SPT52X21 2x21W T5 900mm

- Πολυκαρβονικό γαλακτερό κάλυμμα / PC opal cover.
- Φωτισμός μονής δέσμης / Down beam lighting.
- Minimal Design.
- Ιδανικός φωτισμός γραφείου / Ideal office lighting.

ΓΚΡΙ ΑΛΟΥΜΙΝΙΟΥ
ALUMINUM GREY

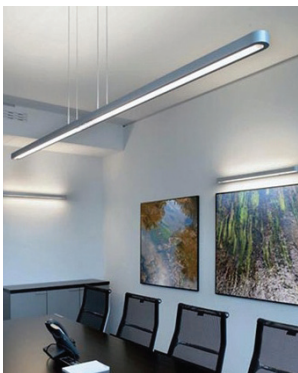

Απλίκες τοίχου διπλής δέσμης / Up-down wall luminaires T5 APTOR

APT51X21



APT51X14



APT51X8

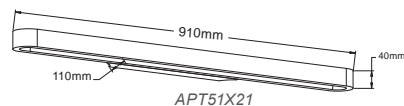
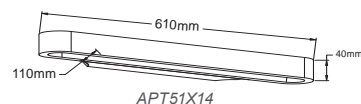
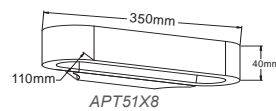

*APT51X8 1x8W T5 350mm

*APT51X14 1x14W T5 600mm

*APT51X21 1x21W T5 900mm

- Πολυκαρβονικό γαλακτερό κάλυμμα / PC opal cover.
- Φωτισμός διπλής δέσμης / Up-down beam lighting.
- Minimal Design.
- Ιδανικός φωτισμός για διαδρόμους / Ideal corridor lighting.

ΓΚΡΙ ΑΛΟΥΜΙΝΙΟΥ
ALUMINUM GREY

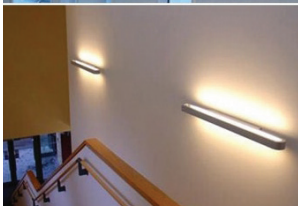

*Υπό κατάργηση / Under abolition

Γραμμικά κρεμαστά φωτιστικά / Linear pendant luminaires T5 **INTERNY**



INTERNY11424

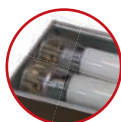

SW52



MC5290



MC52180



***INTERNY11424** 1x14-24W T5 600mm με ανταυγαστήρα αλουμινίου / With aluminum reflector

***INTERNY12139** 1x21-39W T5 900mm με ανταυγαστήρα αλουμινίου / With aluminum reflector

***INTERNY12854** 1x28-54W T5 1200mm με ανταυγαστήρα αλουμινίου / With aluminum reflector

***INTERNY13549** 1x35-49W T5 1500mm με ανταυγαστήρα αλουμινίου / With aluminum reflector

***INTERNY180** 1x80W T5 1500mm με ανταυγαστήρα αλουμινίου / With aluminum reflector

INTERNY21424 2x14-24W T5 600mm

INTERNY22139 2x21-39W T5 900mm

INTERNY22854 2x28-54W T5 1200mm

INTERNY23549 2x35-49W T5 1500mm

INTERNY280 2x80W T5 1500mm

Στις παραπάνω τιμές συμπεριλαμβάνεται μπάλαστ Osram, Helvar ή Tridonic
Above prices include ballast Osram, Helvar or Tridonic

SW52 Ατσάλενα ντίγια 2 μέτρων με ρυθμιζόμενο ύψος / Steel wire 2m with adjustable height

MC52180 Μεταλλικός σύνδεσμος ευθείας / Metallic straight connector

MC5290 Μεταλλικός σύνδεσμος γωνίας 90° / Metallic 90° corner connector

- Υψηλής καθαρότητας προφίλ αλουμινίου / High purity aluminum profile.
- Ανταυγαστήρας ανοδιωμένου αλουμινίου / Anodized aluminum reflector.
- Ημιδιαφάνες πολυκαρβονικό κάλυμμα / Semi clear PC cover.
- Διάφανα ντουί και κλιπ T5 για αποφυγή σκιάσεων / Transparent lamp holder and clip to avoid shadows.

***Ο ανταυγαστήρας αλουμινίου τοποθετείται μόνο στα μονά φωτιστικά (π.χ. 1x14W).**
Aluminum reflector is installed only in single lamp fixtures (eg. 1x14W).

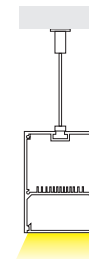
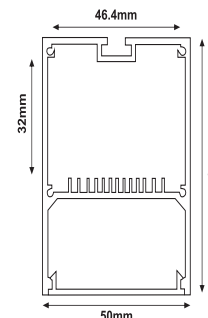

Δυνατότητα ηλεκτροστατικής βαφής με RAL της επιλογής σας με επιπλέον κόστος.
Ability of powder coating paint with RAL of your choice with extra cost.

Γραμμικά κωνευτά φωτιστικά / Linear recessed luminaires T5 **RECY**



RECY11424

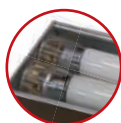

MC45



MCP180



MCP90



***RECY11424** 1x14-24W T5 600mm με ανταυγαστήρα αλουμινίου / With aluminum reflector

***RECY12139** 1x21-39W T5 900mm με ανταυγαστήρα αλουμινίου / With aluminum reflector

***RECY12854** 1x28-54W T5 1200mm με ανταυγαστήρα αλουμινίου / With aluminum reflector

***RECY13549** 1x35-49W T5 1500mm με ανταυγαστήρα αλουμινίου / With aluminum reflector

***RECY180** 1x80W T5 1500mm με ανταυγαστήρα αλουμινίου / With aluminum reflector

RECY21424 2x14-24W T5 600mm

RECY22139 2x21-39W T5 900mm

RECY22854 2x28-54W T5 1200mm

RECY23549 2x35-49W T5 1500mm

RECY280 2x80W T5 1500mm

Στις παραπάνω τιμές συμπεριλαμβάνεται μπάλαστ Osram, Helvar ή Tridonic
Above prices include ballast Osram, Helvar or Tridonic

MC45 Μεταλ. κλιπς στερέωσης / Metallic mounting clip

MCP180 Μεταλλικός σύνδεσμος ευθείας / Metallic straight connector

MCP90 Μεταλλικός σύνδεσμος γωνίας 90° / Metallic 90° corner connector

- Υψηλής καθαρότητας προφίλ αλουμινίου / High purity aluminum profile.
- Ανταυγαστήρας ανοδιωμένου αλουμινίου / Anodized aluminum reflector.
- Ημιδιαφάνες πολυκαρβονικό κάλυμμα / Semi clear PC cover.
- Διάφανα ντουί και κλιπ T5 για αποφυγή σκιάσεων / Transparent lamp holder and clip to avoid shadows.

***Ο ανταυγαστήρας αλουμινίου τοποθετείται μόνο στα μονά φωτιστικά (π.χ. 1x14W).**
Aluminum reflector is installed only in single lamp fixtures (eg. 1x14W).

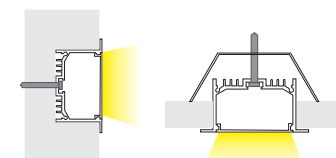
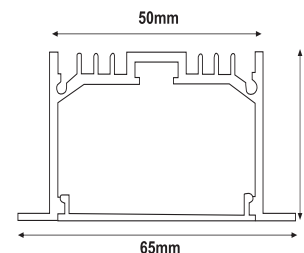

Δυνατότητα ηλεκτροστατικής βαφής με RAL της επιλογής σας με επιπλέον κόστος.
Ability of powder coating paint with RAL of your choice with extra cost.

Φωτιστικά οροφής / Ceiling luminaires T8

IP20



ΓΚΡΙ
GREY

Με μαγνητικό μετασχηματιστή B2
With magnetic ballast B2

*W1X18GREY 1x18W

*W1X36GREY 1x36W

*Υπό κατάργηση / Under abolition

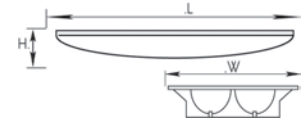

L W H

W1X18GREY 635 x 350 x 65mm

W1X36GREY 1245 x 350 x 65mm

Φωτιστικά ορυκτής ίνας / Mineral fiber luminaires T8

IP45



ERKE418IP440

Με ηλεκτρονικό μετασχηματιστή
With electronic ballast

Με γαλακτερό κάλυμμα / With opal cover

ERKE118IP440 1x18W

ERKE418IP440 4x18W

ERKE236IP440 2x36W

Με διαφανές κάλυμμα / With clear cover

ERKE136IP44P 1x36W

ERKE236IP44P 2x36W

ERKE418IP44P 4x18W

- Σώμα από ασάλι / Steel body.
- Λευκή ηλεκτροστατική βαφή / White electrostatic paint.
- Ντουί / Lampholder G13 T8.



L W H

ERKE118IP440 600 x 200 x 82mm

ERKE418IP440/P 595 x 595 x 82mm

ERKE136IP44P 1195 x 200 x 82mm

ERKE236IP440/P 1195 x 295 x 82mm

Φωτιστικά οροφής / Ceiling luminaires T8

IP45



PS236IP400

Με ηλεκτρονικό μετασχηματιστή
With electronic ballast

Με κρυσταλιζε κάλυμμα / With crystalize cover

PS118IP400 1x18W

PS218IP400 2x18W

PS418IP400 4x18W

PS136IP400 1x36W

PS236IP400 2x36W

PS158IP400 1x58W

PS258IP400 2x58W

Με διαφανές κάλυμμα / With clear cover

PS418IP40P 4x18W

PS236IP400 2x36W

PS158IP400 1x58W

PS258IP400 2x58W

- Σώμα από ασάλι / Steel body.
- Λευκή ηλεκτροστατική βαφή / White electrostatic paint.
- Κρυσταλιζε κάλυμμα / Crystalize cover.
- Ντουί / Lampholder G13 T8.

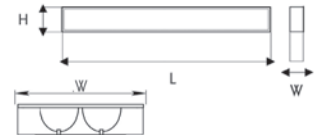

L W H

PS118IP400 610 x 185 x 70mm

PS218IP400 610 x 290 x 70mm

PS418IP400/P 610 x 610 x 70mm

PS136IP400 1220 x 185 x 70mm

PS236IP400/P 1220 x 290 x 70mm

PS158IP400/P 1520 x 185 x 70mm

PS258IP400/P 1520 x 290 x 70mm

Φωτιστικά οροφής inox / Surface aluminum inox luminaires T8

Κενά φωτιστικά για λαμπτήρες LED
Empty luminaires for LED lamps

*VS218IP20 Λευκό / White

*VS418IP20 Λευκό / White

*VS236IP20 Λευκό / White

*VS258IP20 Λευκό / White

Με ηλεκτρονικό μετασχηματιστή
With electronic ballast

*VS218IP20E 2x18W Λευκό / White

*VS418IP20E 4x18W Λευκό / White

*VS418IP20I 4x18W Γκρι / Grey

*VS236IP20E 2x36W Λευκό / White

*VS258IP20E 2x58W Λευκό / White



VS418IP20E

ΛΕΥΚΟ
WHITE

ΓΚΡΙ
GREY

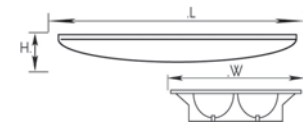

L W H

VS218IP20/E 621 x 284 x 52mm

VS236IP20/E 1231 x 284 x 52mm

VS258IP20/E 1531 x 284 x 52mm

VS418IP20/E 621 x 444 x 52mm

VS418IP20I 621 x 444 x 52mm



Δυνατότητα ηλεκτροστατικής βαφής με RAL της επιλογής σας
Ability of powder coating paint with RAL of your choice

*Υπό κατάργηση / Under abolition

Συνδεόμενα φωτιστικά φθορισμού / Linkable luminaires T5

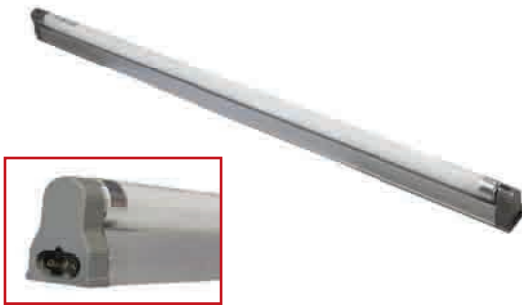

*GNT514ML 1x14W 57 x 22mm

*GNT528ML 1x28W 117 x 22 x 33mm

- Σώμα από αλουμίνιο / Aluminum body.
- Συμπεριλαμβάνονται ταχυσύνδεσμοι & κλιπς / Included fast connectors & clips.

Συνδεόμενα φωτιστικά φθορισμού με ανταυγαστήρα / Linkable luminaires with reflector T5



*GNT514MLF 1x14W 57 x 46mm

*GNT528MLF 1x28W 117 x 46 x 33mm

- Σώμα από αλουμίνιο / Aluminum body.
- Ασύμμετρος ανταυγαστήρας αλουμινίου / Asymmetry aluminum reflector.
- Συμπεριλαμβάνονται ταχυσύνδεσμοι & κλιπς / Included fast connectors & clips.

Κρεμαστά φωτιστικά φθορισμού / Pendant luminaires T5 EXTRA SLIM



MD930AY28X2

*MD930AY28X2 2x28W

*MD932Y28X2 2x28W

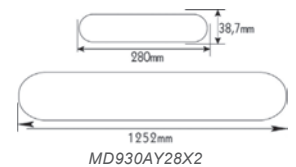

MD930AY28X2



MD932Y28X2

- Σώμα από αλουμίνιο / Aluminum body.
- Ακρυλικό κάλυμμα / Acrylic cover.
- Συμπεριλαμβάνονται ντίτζες απο ασάλι / Included steel wires.



MD932Y28X2

Τερματικά / End caps



*MD930B No 930 Μπλε / Blue

*MD932B No 932 Μπλε / Blue

*MD932O No 932 Πορτοκαλί / Orange

*MD932Y No 932 Κίτρινο / Yellow



MD930B



MD932B/O/Y

- Πλαστικά τερματικά σε διάφορα χρώματα /
- Plastic caps into different colors.

Φωτιστικά φθορισμού / Fluorescent luminaires T5 - T8 TUBO



Χρωματολόγιο / Colors



Και σε άλλα RAL κατόπιν συνηγορίας
More RAL colors available under demand

G5 / T5

AC.1001T 1x14 / 24W

AC.1003T 1x18 / 54W

AC.1004T 1x35 / 49 / 80W

G13 / T8 κενά για LED
G13 / T8 empty for LED

AC.1001LED 1,13m 60cm lamp

AC.1002LED 1,50m 90-100cm lamp

AC.1003LED 1,73m 120cm lamp

AC.1004LED 2,03m 150cm lamp

G13 / T8 με ηλεκτρονικό ballast
G13 / T8 with electronic ballast

AC.1001L 1x18W 1,13m

AC.1003L 1x36W 1,73m

AC.1004L 1x58W 2,03m

G13 / T8 με μαγνητικό ballast
G13 / T8 with magnetic ballast

AC.1001 1x18W 1,13m

AC.1002 1x23W 1,50m

AC.1003 1x36W 1,73m

AC.1004 1x58W 2,03m

- Σώμα από αλουμίνιο / Aluminum body.
- Καθρέπτης ανοδιωμένου αλουμινίου / Anodized aluminum reflector.
- Ντουί / Lampholder G5 T5 - G13 T8.

Εξαρτήματα σύνδεσης TUBO
Connection accessories for TUBO

AC.1005 Περισίδα λευκή /
White grid 300mm

AC.1005C Περισίδα διάφανη /
Clear grid 300mm

AC.1006(B) Φυσούνα λευκή
(μαύρη) / White (black) grid tube

AC.1007(B) Γωνία 90° λευκή
(μαύρη) / White (black) 90° angle

AC.1008(B) Γωνία "T" λευκή
(μαύρη) / White (black) "T" angle

AC.1009(B) Γωνία σταυρός
Λευκός (μαύρος) / White (black)
cross angle

AC.1000(B) Γωνία αστέρι λευκό
(μαύρο) / White (black) star angle

AC.1011(B) Σύνδεσμος ευθείας
Λευκός (μαύρος) / White (black)
straight connector

AC.1012(B) Τάπα λευκή (μαύρη) /
White (black) end-cap

AC.1013 Σετ εγκατάστασης
οροφής / Ceiling installation kit

AC.1014 Σετ εγκατάστασης
κρέμασης / Pendant installation kit



Διπλά φωτιστικά φθορισμού τύπου χελιδόνη / Double fluorescent luminaires T5 - T8 MARTIN



Χρωματολόγιο / Colors



G5 / T5

AC.1061T 2x14 / 24W

AC.1063T 2x18 / 54W

AC.1064T 2x35 / 49 / 80W

G13 / T8 κενά για LED
G13 / T8 empty for LED

AC.1061LED 1,13m 60cm lamp

AC.1062LED 1,50m 90-100cm lamp

AC.1063LED 1,73m 120cm lamp

AC.1064LED 2,03m 150cm lamp

G13 / T8 με ηλεκτρονικό ballast
G13 / T8 with electronic ballast

AC.1061L 2x18W 1,13m

AC.1063L 2x36W 1,73m

AC.1064L 2x58W 2,03m

G13 / T8 με μαγνητικό ballast
G13 / T8 with magnetic ballast

AC.1061 2x18W 1,13m

AC.1062 2x23W 1,50m

AC.1063 2x36W 1,73m

AC.1064 2x58W 2,03m

- Σώμα από αλουμίνιο / Aluminum body.
- Καθρέπτης ανοδιωμένου αλουμινίου / Anodized aluminum reflector.
- Ντουί / Lampholder G5 T5 - G13 T8.

Εξαρτήματα σύνδεσης MARTIN
Connection accessories for MARTIN

AC.1065 Περισίδα διάφανη /
Clear grid 300mm

AC.1066(B) Φυσούνα λευκή
(μαύρη) / White (black) grid tube

AC.1067(B) Γωνία 90° λευκή
(μαύρη) / White (black) 90° Angle

AC.1068(B) Μεταβλητή γωνία
Λευκή (μαύρη) / White (black)
adjustable angle

AC.1069(B) Γωνία σταυρός
Λευκός (μαύρος) / White (black)
cross angle

AC.10610(B) Γωνία "T" λευκή
(μαύρη) / White (black) "T" angle

AC.10611(B) Τάπα προέκτασης
Λευκή (μαύρη) / White (black)
extension end-cap

AC.10612(B) Τάπα λευκή (μαύρη)
/ White (black) end-cap

AC.10613 Μαστός ένωσης /
Connector

AC.1013 Σετ εγκατάστασης
οροφής / Ceiling installation kit

AC.1014 Σετ εγκατάστασης
κρέμασης / Pendant installation kit



Φωτιστικό οροφής διπλό φθορισμού / Ceiling double fluorescent luminaire T8



ΝΙΚΕΛ ΜΑΤ
NICKEL MATT

*AC.045XF218D 2x18W

- Σώμα αλουμινίου / Aluminum body.
- Ξύλινη επιφάνεια / Wooden surface.
- Ντουί / Lampholder 2 x G13 T8.

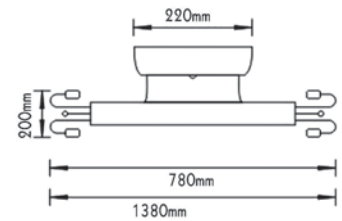

Κρεμαστό διπλό φωτιστικό φθορισμού / Pendant double fluorescent luminaire T8

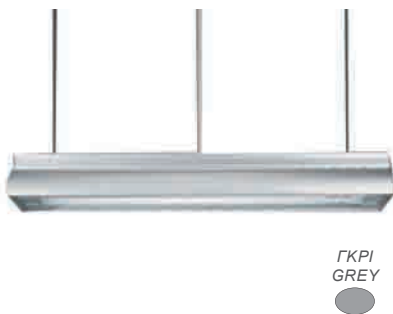

ΓΚΡΙ
GREY

*AC.045XF218C 2x18W

- Σώμα από αλουμίνιο / Aluminum body.
- Πυρίμαχο γυαλί / Fire-resistant glass.
- Ντουί / Lampholder 2 x G13 T8.

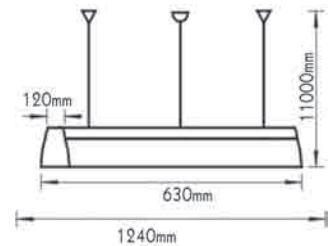

Κρεμαστό διπλό φωτιστικό φθορισμού / Pendant double fluorescent luminaire T5

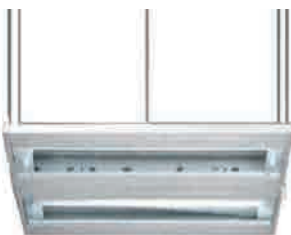

AC.045XF221A



AC.045XF221B

ΓΚΡΙ
GREY

*AC.045XF221A 2x21W

*AC.045XF221B 2x21W

- Σώμα από αλουμίνιο / Aluminum body.
- Πυρίμαχο γυαλί / Fire-resistant glass.
- Ντουί / Lampholder 2 x G5 T5.

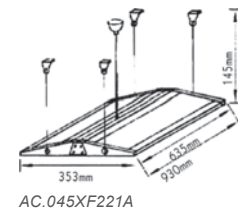

AC.045XF221A

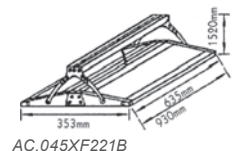

AC.045XF221B

Κρεμαστό κρυστάλλινο φθορισμού / Crystal pendant luminaire T5



ΚΡΥΣΤΑΛΛΟ / CRYSTAL

*MD67051A 1x39W

- Μέταλλο υψηλής διαύγειας / High clarity crystal.
- Ιnox λεπτομέρειες / Inox details.
- Ντουί / Lampholder G5 T5.
- Συμπεριλαμβάνεται λαμπτήρας / Included T5 lamp 4200K.

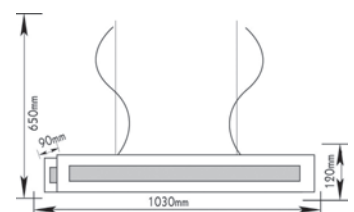

Φωτιστικά πλακέ φθορισμού T4 / T4 fluorescent luminaire



***28068 8W T4**

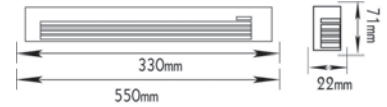

ΛΕΥΚΟ
WHITE



- Πλαστικό σώμα / Plastic body.
- Πολυκαρμπονάτ κάλυμμα/ PC cover.
- Ντουί / Lampholder T4.
- Συμπεριλαμβάνεται ο λαμπτήρας / Lamp is included.

Φωτιστικό φθορισμού T5 ρυθμιζόμενο / Adjustable T5 fluorescent luminaire



***T508Y081 8W T5**

***T521Y081 20W T5**

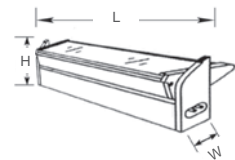

ΓΚΡΙ
GREY



- Σώμα από χυτό αλουμίνιο / Die-casting aluminum body.
- Καθρέπτης αλουμινίου / Aluminum reflector.
- Πυρίμαχο γυαλί / Fire-resistant glass.
- Ντουί / Lampholder G5 T5.

T508Y081 355 x 28 x 82mm

T521Y081 915 x 28 x 82mm

Φωτιστικό φθορισμού T5 / T5 fluorescent luminaire



ΛΕΥΚΟ
WHITE



***CAB048W 8W T5**

***CAB0414W 13W T5**

***CAB0421W 21W T5**

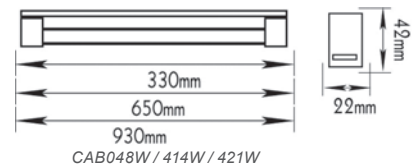

- Πλαστικό σώμα / Plastic body.
- Πολυκαρμπονάτ κάλυμμα/ PC cover.
- Ντουί / Lampholder T5.

CAB048W / 414W / 421W

Συνδεόμενο φωτιστικό φθορισμού / Linkable fluorescent luminaire T4



ΛΕΥΚΟ
WHITE



***28070 8W T4**

***28071 12W T4**

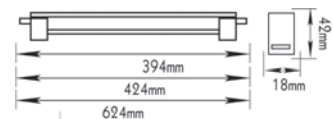

- Πλαστικό σώμα / Plastic body.
- Πολυκαρμπονάτ κάλυμμα/ PC cover.
- Ντουί / Lampholder T4.

Χωνευτά στρογγυλά σποτ / Recessed round spot luminaires GU5.3 MR16 - GU10

Ατσάλι / Steel

12V | GU5.3 MR16 max. 50W
230V | GU10 max. 50W

AC.0451042W Λευκό / White

AC.0451042WB Μαύρο / Black

AC.0451042SG Γκρι βαφής / Silver grey

AC.0451042EG Μεταλ. γκρι / Metallic grey

AC.0451042NM Νίκελ ματ / Nickel matt

AC.0451042N Νίκελ / Nickel

AC.0451042GA Μπρονζέ / Bronze

AC.0451042RA Χάλκινο / Copper

AC.0451042GM Χρυσό ματ / Matt gold

AC.0451042G Χρυσό / Gold

*AC.0451042PG Χρυσό περλέ / Pearl gold

*AC.0451042PN Νίκελ περλέ / Pearl nickel

*AC.0451042PS Ασημί περλέ / Pearl silver

Αλουμίνιο / Aluminum

12V | GU5.3 MR16 max. 50W
230V | GU10 max. 50W

AC.0451042NMA Νίκελ ματ / Nickel matt

AC.0451042NA Νίκελ / Nickel

- Σώμα από ατσάλι ή αλουμίνιο / Steel or aluminum body.
- Ντουί / Lampholder GU5.3 MR16, GU10.

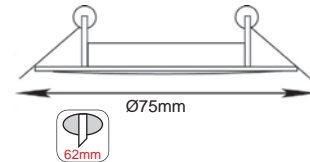

AC.0451042W



AC.0451042WB



AC.0451042SG



AC.0451042EG



AC.0451042RA



AC.0451042NM



AC.0451042N



AC.0451042GA



AC.0451042GM



AC.0451042G



AC.0451042PG



AC.0451042PN



AC.0451042PS



AC.0451042NMA



AC.0451042NA

ΛΕΥΚΟ
WHITE



ΜΑΥΡΟ
BLACK



ΓΚΡΙ/ΜΕΤΑΛ
GREY/METAL



ΝΙΚΕΛ/ΜΑΤ
NICKEL/MATT



ΧΡΥΣΟ/ΜΑΤ
GOLD/MATT



ΜΠΡΟΝΖΕ
BRONZE



ΧΑΛΚΙΝΟ
COPPER



Χωνευτά πλαστικά στρογγυλά σποτ / Recessed plastic round spot luminaires GU10



1042WPC

ΛΕΥΚΟ
WHITE



ΓΚΡΙ
GREY



230V | GU10 max. 50W

1042WPC Λευκό / White

1042GPC Γκρι / Grey

**Σημείωση: Διατίθεται σε συσκευασία των 2 τεμαχίων.
Notice: Available in packs of 2 pieces.**

- Πλαστικό σώμα / Plastic body.
- Αποσπώσιμο δαχτυλίδι για εύκολη εγκατάσταση-συντήρηση / Removable ring for easy installation-maintenance.
- Ντουί / Lampholder GU10.

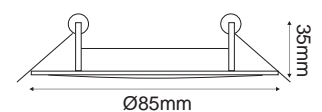

*Υπό κατάργηση / Under abolition

Χωνευτά στρογγυλά σποτ δίχρωμα / Recessed 2color round spot luminaires GU5.3 MR16 - GU10

12V | GU5.3 MR16 max. 50W
230V | GU10 max. 50W

- Χυτό αλουμίνιο / Die casting aluminum.
- Ντουί / Lampholder GU5.3 MR16, GU10.

*AC.04531GPGG Χρυσό - Χρυσό περλέ / Gold - Pearl gold

*AC.04531GPBG Χρυσό - Αιματίτης / Gold - Hematite

*AC.04531GPG Χρυσό- Ασημί περλέ / Gold - Pearl silver

*AC.04531SPGS Ασημί - Χρυσό περλέ / Silver - Pearl gold

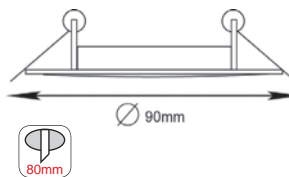

AC.04531GPGG



AC.04531GPG



AC.04531GPBG



AC.04531SPGS

ΧΡΥΣΟ-ΠΕΡΛΕ
GOLD-PEARL



ΧΡΥΣΟ-ΑΙΜΑΤΙΤΗΣ
GOLD-HEMATITE



ΧΡΥΣΟ-ΑΣΗΜΙ
GOLD-SILVER



Χωνευτά στρογγυλά σποτ / Recessed round spot luminaires G4 - MR11

12V | G4 max. 20W - MR11 max. 35W

BS3161W Λευκό / White

BS3161SG Γκρι βαφής / Silver grey

BS3161NM Νίκελ ματ / Nickel matt

BS3161N Νίκελ / Nickel

BS3161CP Ασημί / Silver

BS3161GAB Μπρονζέ / Bronze

BS3161G Χρυσό / Gold

BS3161GM Χρυσό ματ / Matt gold

BS3161RAB Χάλκινο / Copper

- Σώμα χυτού αλουμινίου / Aluminum die-casting body.
- Ντουί / Lampholder G4 MR11.

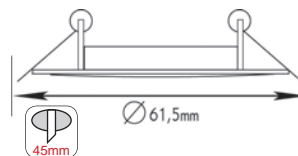

BS3161W



BS3161SG



BS3161CP



BS3161NM



BS3161N



BS3161GAB



BS3161RAB



BS3161G



BS3161GM

ΛΕΥΚΟ
WHITE



ΓΚΡΙ
GREY



ΝΙΚΕΛ/ΜΑΤ
NICKEL/MATT



ΑΣΗΜΙ
SILVER



ΧΡΥΣΟ/ΜΑΤ
GOLD/MATT



ΜΠΡΟΝΖΕ
BRONZE



ΧΑΛΚΙΝΟ
COPPER



*Υπό κατάργηση / Under abolition

Χωνευτά στρογγυλά σποτ / Recessed round spot luminaires G4

12V | G4 max. 20W

- BS3153NW** Λευκό / White
- BS3153NRAB** Χάλκινο / Copper
- BS3153NSG** Γκρι βαφής / Gray paint
- BS3153NNM** Νίκελ ματ / Nickel matt
- BS3153NCP** Νίκελ / Nickel
- BS3153NGAB** Μπρονζέ / Bronze
- BS3153NG** Χρυσό / Gold
- BS3153NGM** Χρυσό ματ / Matt gold

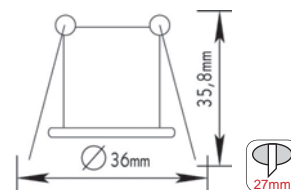

BS3153NW



BS3153NSG



BS3153NNM



BS3153NCP



BS3153NG



BS3153NGM



BS3153NGAB



BS3153NRAB

12V | G4 max. 20W

- BS3153AW** Λευκό / White
- BS3153AN** Νίκελ / Nickel
- BS3153ANM** Νίκελ ματ / Nickel matt
- BS3153AGM** Χρυσό ματ / Matt gold

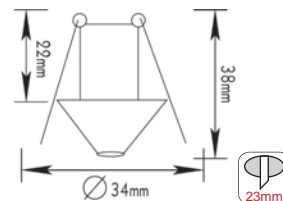

BS3153AW



BS3153AN



BS3153ANM



BS3153AGM

12V | G4 max. 20W

- BS3153W** Λευκό / White
- BS3153N** Νίκελ / Nickel
- BS3153NM** Νίκελ ματ / Nickel matt
- BS3153GM** Χρυσό ματ / Matt gold

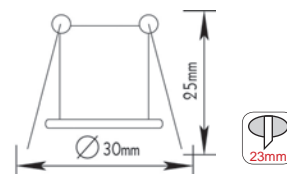

BS3153W



BS3153N



BS3153NM



BS3153GM

- Σώμα χυτού αλουμινίου / Die casting aluminum body.
- Ντουί / Lampholder G4.

ΛΕΥΚΟ WHITE	ΝΙΚΕΛ/ΜΑΤ NICKEL/MATT	ΧΡΥΣΟ/ΜΑΤ GOLD/MATT	ΜΠΡΟΝΖΕ BRONZE

Χωνευτά σποτ / Recessed spot luminaires GU5.3 MR16 - GU10

IP45

12V | GU5.3 MR16 max. 50W
230V | GU10 max. 50W

BS3407NM Νίκελ ματ / Nickel matt

BS3407GM Χρυσό ματ / Matt gold

BS3407GAB Μπρονζέ / Bronze

BS3406NM Νίκελ ματ / Nickel matt

BS3406GM Χρυσό ματ / Matt gold

BS3406GAB Μπρονζέ / Bronze

- Σώμα χυτού αλουμινίου / Die casting aluminum body.
- Πυρίμαχο μάτ γυαλί / Fire-resistant matt glass.
- Ντουί / Lampholder GU5.3 MR16, GU10.

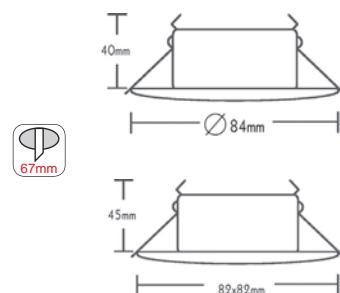

BS3407NM



BS3407GM



BS3407GAB



BS3406NM



BS3406GM



BS3406GAB

ΝΙΚΕΛ ΜΑΤ
NICKEL MATT



ΧΡΥΣΟ ΜΑΤ
GOLD MATT



ΜΠΡΟΝΖΕ
BRONZE



Χωνευτά στρογγυλά σποτ / Recessed round spot luminaires GU5.3 MR16 - GU10

IP45

12V | GU5.3 MR16 max. 50W
230V | GU10 max. 50W

BS3404NM Νίκελ ματ / Nickel matt GU5.3 MR16

BS3405W Λευκό / White GU10

BS3405NM Νίκελ ματ / Nickel matt GU10

- Σώμα χυτού αλουμινίου / Die casting aluminum body.
- Πυρίμαχο πλέγμα γυαλί / Fire-resistant grid glass.
- Ντουί / Lampholder GU5.3 MR16, GU10.

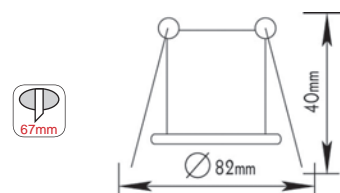

BS3405W



BS3404NM
BS3405NM

ΛΕΥΚΟ
WHITE



ΝΙΚΕΛ ΜΑΤ
NICKEL MATT



Χωνευτά σποτ αρχιτεκτονικού φωτισμού / Recessed architectural spot luminaires GU10

230V | GU10 max. 50W

*GL810001 12LED BLUE + GU10

*GL810002 16LED BLUE + GU10

*GL810006 12LED BLUE + GU10

*GL810007 9LED BLUE + GU10

- Σώμα χυτού αλουμινίου / Aluminum die-casting body.
- Ακρυλικός φακός διάχυσης / Acrylic diffusing lens.
- Ντουί / Lampholder GU10.



GL810001

GL810002



GL810007



GL810006

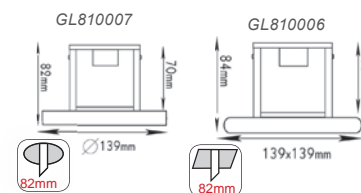
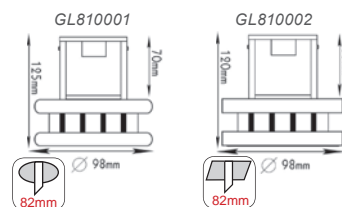

Χωνευτά στρογγυλά κινητά σποτ / Recessed round movable spot luminaires GU10

230V | GU10 max. 50W

AC.045R63KW Λευκό / White

AC.045R63KNM Νίκελ ματ / Nickel matt

AC.045R63KNMA Ανοξ. 316 / Stainless 316

- Σώμα από αστάλι / Steel body.
- Ντουί / Lampholder GU10.

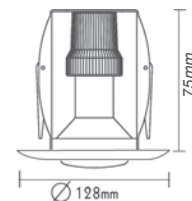

AC.045R63KW



AC.045R63KNM



AC.045R63KNMA

ΛΕΥΚΟ
WHITE



ΝΙΚΕΛ ΜΑΤ
NICKEL MATT



ΑΝΟΞΕΙΔΩΤΟ
STAINLESS



Χωνευτά στρογγυλά σποτ / Recessed round spot luminaires R50 - R63 - R80

230V | R50 E14 max.60W

AC.045R50W Λευκό / White

AC.045R50B Μαύρο / Black

AC.045R50G Γκρι / Grey

AC.045R50NM Νίκελ ματ / Nickel matt

AC.045R50GAB Μπρονζέ / Bronze

AC.045R50GM Χρυσό ματ / Matt gold

AC.045R50GO Χρυσό / Gold

AC.045R50RAB Χάλκινο / Copper



AC.045R50B

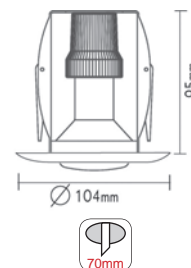

230V | R63 E27 max.60W

AC.045R63W Λευκό / White

AC.045R63B Μαύρο / Black

AC.045R63G Γκρι / Grey

AC.045R63NM Νίκελ ματ / Nickel matt

AC.045R63RAB Χάλκινο / Copper

AC.045R63GAB Μπρονζέ / Bronze

AC.045R63GM Χρυσό ματ / Matt gold

AC.045R63GO Χρυσό / Gold

AC.045R63NMA Ανοξ. 316 / Stainless 316



AC.045R63GAB

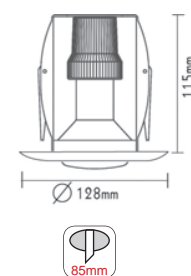

230V | R80 E27 max.75W

AC.045R80W Λευκό / White

AC.045R80B Μαύρο / Black

AC.045R80NM Νίκελ ματ / Nickel matt

AC.045R80RAB Χάλκινο / Copper

AC.045R80GAB Μπρονζέ / Bronze

AC.045R80GO Χρυσό / Gold

AC.045R80GM Χρυσό ματ / Matt gold



AC.045R80NM

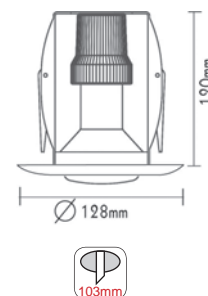

- Σώμα από αστάλι / Steel body.

ΛΕΥΚΟ
WHITE



ΜΑΥΡΟ
BLACK



ΓΚΡΙ
GREY



ΝΙΚΕΛ ΜΑΤ
NICKEL MATT



ΑΝΟΞΕΙΔΩΤΟ
STAINLESS



ΧΡΥΣΟ/ΜΑΤ
GOLD/MATT



ΜΠΡΟΝΖΕ
BRONZE



Χωνευτά στρογγυλά κινητά σποτ / Recessed round movable spot luminaires GU5.3 MR16 - GU10

Ατσάλι / Steel

12V | GU5.3 MR16 max. 50W
230V | GU10 max. 50W

AC.0453254W Λευκό / White

AC.0453254WB Μαύρο / Black

AC.0453254NM Νικελ ματ / Nickel matt

AC.0453254SG Γκρι βαφής / Silver grey

AC.0453254B Μεταλ. γκρι / Metallic grey

AC.0453254PS Νικελ περλέ / Pearl nickel

AC.0453254CP Νικελ / Nickel

AC.0453254GA Μπρονζέ / Bronze

AC.0453254G Χρυσό / Gold

AC.0453254GM Χρυσό ματ / Matt gold

AC.0453254PG Χρυσό περλέ / Pearl gold

AC.0453254RA Χάλκινο / Copper

Αλουμίνιο / Aluminum

12V | GU5.3 MR16 max. 50W
230V | GU10 max. 50W

AC.0453254NMA Νικελ ματ / Nickel matt

AC.0453254CPA Νικελ / Nickel

- Σώμα αλουμινίου ή ατσάλι / Aluminum or steel body.
- Ντρουί / Lampholder GU5.3 MR16 - GU10.

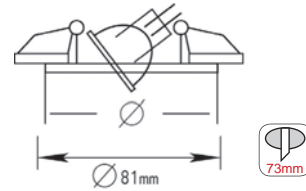

AC.0453254W



AC.0453254WB



AC.0453254NM



AC.0453254SG



AC.0453254B



AC.0453254PS



AC.0453254CP



AC.0453254GA



AC.0453254G



AC.0453254GM



AC.0453254PG



AC.0453254RA



AC.0453254NMA



AC.0453254CPA

ΛΕΥΚΟ
WHITE

ΜΑΥΡΟ
BLACK

ΓΚΡΙ/ΜΕΤΑΛ
GREY/METAL

ΝΙΚΕΛ/ΜΑΤ
NICKEL/MATT

ΧΡΥΣΟ/ΜΑΤ/ΠΕΡΛΕ
GOLD/MATT/PEARL

ΜΠΡΟΝΖΕ
BRONZE

ΧΑΛΚΙΝΟ
COPPER

Χωνευτά στρογγυλά σποτ / Recessed round spot luminaires E27

230V | E27 max.60W

AC.19127W Λευκό / White

AC.19127NM Νίκελ ματ / Nickel matt

AC.045XF300G Χρυσό / Gold

- Σώμα από σσάλι / Steel body.
- Ανταυγαστήρας αλουμινίου υψηλής καθαρότητας / High purity aluminum reflector.
- Ντουί / Lampholder E27.

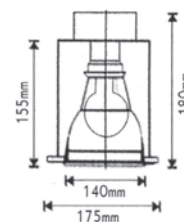

AC.19127W



AC.19127NM



AC.045XF300G

ΛΕΥΚΟ
WHITE



ΝΙΚΕΛ ΜΑΤ
NICKEL MATT



ΧΡΥΣΟ
GOLD



Χωνευτά στρογγυλά κινητά σποτ / Recessed round movable spot luminaires GU5.3 MR16 - GU10

12V | GU5.3 MR16 max. 50W

230V | GU10 max. 50W

AC.04533W Λευκό / White

AC.04533WB Μαύρο / Black

AC.04533NM Νίκελ ματ / Nickel matt

AC.04533G Χρυσό / Gold

AC.04533GM Χρυσό ματ / Matt gold

AC.04533GAB Μπρονζέ / Bronze

AC.04533RAB Χάλκινο / Copper

- Σώμα από σσάλι / Steel body.
- Ντουί / Lampholder GU5.3 MR16 - GU10.

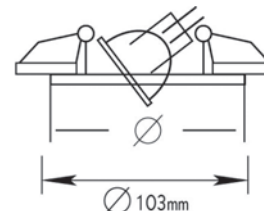

AC.04533W



AC.04533WB



AC.04533NM



AC.04533GAB



AC.04533G



AC.04533GM



AC.04533GAB

ΛΕΥΚΟ
WHITE



ΜΑΥΡΟ
BLACK



ΝΙΚΕΛ ΜΑΤ
NICKEL MATT



ΧΡΥΣΟ/ΜΑΤ
GOLD/MATT



ΜΠΡΟΝΖΕ
BRONZE



ΧΑΛΚΙΝΟ
COPPER



Χωνευτά στρογγυλά κινητά σποτ / Recessed round movable spot luminaires G4 - MR11

12V | G4 max. 20W - MR11 max. 35W

AC.04532W Λευκό / White

BS3259EG Μεταλ. γκρι / Metallic grey

AC.04532NM Νικελ ματ / Nickel matt

AC.04532N Νικελ / Nickel

AC.04532PN Νικελ περλέ / Pearl nickel

AC.04532S Ασημί / Silver

BS3259SPNMS Ασημί - Νικελ ματ περλέ / Silver - Pearl nickel matt

AC.04532SPS Ασημί - Χρυσό περλέ / Silver - Pearl gold

BS3259GPBG Χρυσό - Αιματίτης / Gold - Hematite

BS3259GPG Χρυσό - Χρυσό περλέ / Gold - Pearl gold

BS3259GM Χρυσό ματ / Matt gold

AC.04532G Χρυσό / Gold

AC.04532PG Χρυσό περλέ / Pearl gold

AC.04532GPG Χρυσό - Ασημί περλέ / Gold - Pearl silver

AC.04532GAB Μπρονζέ / Bronze

AC.04532RAB Χάλκινο / Copper

- Σώμα από ατσάλι / Steel body.
- Ντουί / Lampholder G4 MR11.

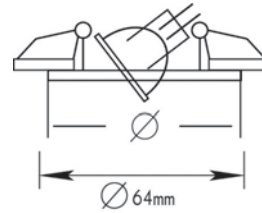

AC.04532W



BS3259EG



AC.04532NM



AC.04532N



AC.04532PN



AC.04532S



BS3259SPNMS



AC.04532SPS



BS3259GPBG



BS3259GPG



BS3259GM



AC.04532G



AC.04532PG



AC.04532GPG



AC.04532GAB



AC.04532RAB

ΛΕΥΚΟ
WHITE

ΓΚΡΙ/ΜΕΤΑΛ
GREY/METAL

ΑΣΗΜΙ
SILVER

ΝΙΚΕΛ/ΜΑΤ/ΠΕΑΛ
NICKEL/MATT/PEAL

ΧΡΥΣΟ/ΜΑΤ/ΠΕΑΛ
GOLD/MATT/PEAL

ΧΡΥΣΟ-ΑΙΜΑΤΙΤΗΣ
GOLD-HEMATITE

ΧΡΥΣΟ-ΑΣΗΜΙ
GOLD-SILVER

ΜΠΡΟΝΖΕ
BRONZE

ΧΑΛΚΙΝΟ
COPPER

Χωνευτά στρογγυλά κινητά σποτ / Recessed round movable spot luminaires GU5.3 MR16 - GU10

12V | GU5.3 MR16 max. 50W
230V | GU10 max. 50W

*AC.045MRCHN Χρώμιο / Chrome

*AC.045MRCHG Χρυσό / Gold

*AC.045MR16CB Χρώμιο / Chrome

*BS3371W Λευκό / White

*BS3371NM Νίκελ ματ / Nickel matt

*BS3371GM Χρυσό ματ / Matt gold

*BS3371GAB Μπρονζέ / Bronze

- Σώμα χυτού αλουμινίου / Die-casting aluminum.
- Κινητή δέσμη έως 90° / Movable beam till 90°.
- Ντουί / Lampholder GU5.3 MR16 - GU10.

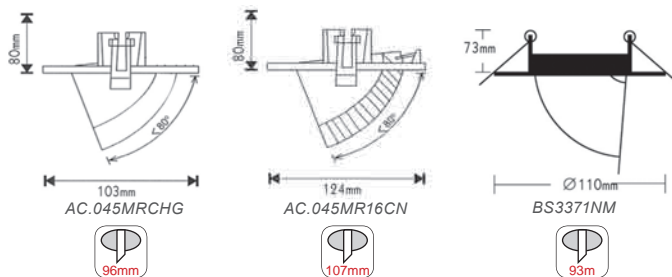

AC.045MRCHN



AC.045MRCHG



AC.045MR16CB



BS3371W



BS3371NM



BS3371GM



BS3371GAB

ΛΕΥΚΟ
WHITE

ΝΙΚΕΛ/ΜΑΤ
NICKEL/MATT

ΧΡΩΜΙΟ
CHROME

ΧΡΥΣΟ/ΜΑΤ
GOLD/MATT

ΜΠΡΟΝΖΕ
BRONZE

Χωνευτά σποτ κρυφού φωτισμού / Recessed trimless spot luminaires GU10



GL5300467W



GL5300468B

230V | GU10 max. 50W

GL5300467W Λευκό / White

GL5300467B Μαύρο / Black

GL5300468W Λευκό / White

GL5300468B Μαύρο / Black

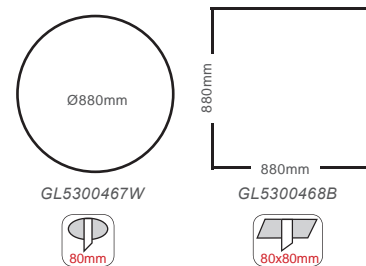

- Σώμα από σπασάλι / Steel body
- Ντουί / Lampholder GU10

ΛΕΥΚΟ
WHITE

ΜΑΥΡΟ
BLACK



Τοποθετείστε / Install
LED Module WISP
10W COB



Και σε άλλα RAL κατόπιν συνεννόησης
More RAL colors available under demand

Χωνευτά τετράγωνα σποτ / Recessed square spot luminaires GU5.3 MR16 - GU10

12V | GU5.3 MR16 max. 50W
230V | GU10 max. 50W

BS3159WMMR16 Λευκό / White

BS3159EGMR16 Μεταλ. γκρι / Metallic grey

BS3159NMMR16 Νικελ ματ / Nickel matt

BS3159CPMR16 Χρώμιο / Chrome

BS3159GMMR16 Χρυσό ματ / Matt gold

BS3159GABMR16 Μπρονζέ / Bronze

- Σώμα αλουμινίου / Aluminum body.
- Ντουί / Lampholder GU5.3 MR16 - GU10.

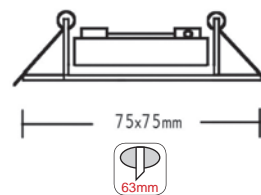

BS3159WMMR16



BS3159EGMR16



BS3159NMMR16



BS3159CPMR16



BS3159GMMR16



BS3159GABMR16



ΛΕΥΚΟ
WHITE



ΓΚΡΙ ΜΕΤΑΛ.
GREY METAL.



ΝΙΚΕΛ ΜΑΤ
NICKEL MATT



ΧΡΩΜΙΟ
CHROME



ΧΡΥΣΟ ΜΑΤ
GOLD MATT



ΜΠΡΟΝΖΕ
BRONZE

Χωνευτά τετράγωνα σποτ / Recessed square spot luminaires G4 - MR11

12V | G4 max. 20W - MR11 max. 35W

BS3154WMMR11 Λευκό / White

BS3154NMMR11 Νικελ ματ / Nickel matt

BS3154CPMR11 Νικελ / Nickel

BS3154EGMR11 Γκρι / Grey

BS3154GABMR11 Μπρονζέ / Bronze

BS3154GMMR11 Χρυσό ματ / Matt gold

- Σώμα αλουμινίου / Aluminum body
- Ντουί / Lampholder G4 - MR11

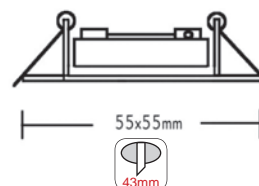

BS3154WMMR11



BS3154EGMR11



BS3154NMMR11



BS3154CPMR11



BS3154GMMR11



BS3154GABMR11



ΛΕΥΚΟ
WHITE



ΓΚΡΙ ΜΕΤΑΛ.
GREY METAL.



ΝΙΚΕΛ ΜΑΤ
NICKEL MATT



ΧΡΩΜΙΟ
CHROME



ΧΡΥΣΟ ΜΑΤ
GOLD MATT



ΜΠΡΟΝΖΕ
BRONZE

Χωνευτά τετράγωνα σποτ κρυφού φωτισμού / Recessed square hidden spot luminaires GU5.3 MR16

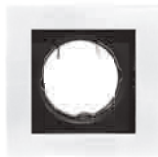

BS3167W



BS3167NM

12V | GU5.3 MR16 max. 50W

BS3167W Λευκό / White

BS3167NM Νίκελ ματ / Nickel matt

- Σώμα αλουμινίου / Aluminum body.
- Ντουί / Lampholder GU5.3 MR16.



ΛΕΥΚΟ
WHITE



NIKEL MAT
NICKEL MATT

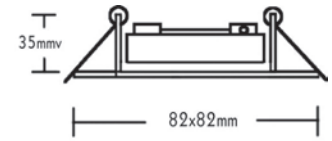

Χωνευτά τετράγωνα κινητά σποτ / Recessed square movable spot luminaires GU5.3 MR16 - GU10



BS3261NMMR16



BS3261CPMR16

12V | GU5.3 MR16 max. 50W

230V | GU10 max. 50W

BS3261EGMR16 Μεταλ. γκρι / Metallic grey

BS3261NMMR16 Νίκελ ματ / Nickel matt

BS3261CPMR16 Νίκελ / Nickel

BS3261GMMR16 Χρυσό ματ / Matt gold

BS3261GABMR16 Μπρονζέ / Bronze

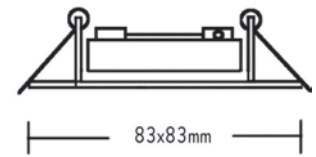

BS3261EGMR16



BS3261GMMR16



BS3261GABMR16



BS3234FNM

BS3234FNM Νίκελ ματ / Nickel matt

5.80€

- Σώμα αλουμινίου / Aluminum body.
- Ντουί / Lampholder GU5.3 MR16 - GU10.



ΓΚΡΙ ΜΕΤΑΛ.
GREY METAL.



NIKEL/MAT
NICKEL/MATT



ΧΡΥΣΟ MAT
GOLD MATT



ΜΠΡΟΝΖΕ
BRONZE

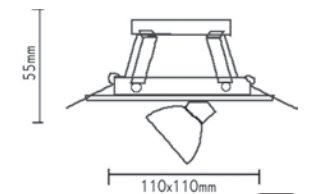

Χωνευτά τετράγωνα κινητά σποτ / Recessed square movable spot luminaires G4 - MR11



BS3262NMMR11



BS3262CPMR11

12V | G4 max. 20W - MR11 max. 35W

BS3262EGMR11 Μεταλ. γκρι / Metallic grey

BS3262NMMR11 Νίκελ ματ / Nickel matt

BS3262CPMR11 Νίκελ / Nickel

BS3262GMMR11 Χρυσό ματ / Matt gold

BS3262GABMR11 Μπρονζέ / Bronze

- Σώμα αλουμινίου / Aluminum body.
- Ντουί / Lampholder G4 - MR11.

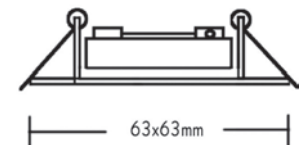

BS3262EGMR11



BS3262GMMR11



BS3262GABMR11



ΓΚΡΙ ΜΕΤΑΛ.
GREY METAL.



NIKEL/MAT
NICKEL/MATT



ΧΡΥΣΟ MAT
GOLD MATT



ΜΠΡΟΝΖΕ
BRONZE

Χωνευτά στρογγυλά σποτ επίπλου / Recessed round furniture spot luminaires G4

12V | G4 max. 20W

AC.045B813W Λευκό / White

AC.045B813NM Νίκελ ματ / Nickel matt

AC.045B813N Νίκελ / Nickel

AC.045B813G Χρυσό / Gold

AC.045B813GM Χρυσό ματ / Matt gold

AC.045B813GAB Μπρονζέ / Bronze

- Σώμα από αστάλι / Steel body.
- Ντουί / Lampholder G4.

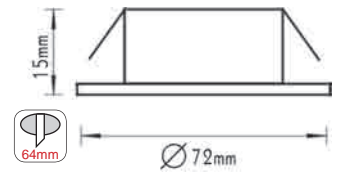

AC.045B813W



AC.045B813N



AC.045B813NM



AC.045B813G



AC.045B813GM



AC.045B813GAB

12V | G4 max. 20W

AC.045XFPW Λευκό / White

AC.045XFPN Νίκελ ματ / Nickel matt

AC.045XFPG Χρυσό / Gold

BS812GM Χρυσό ματ / Matt gold

BS812GAB Μπρονζέ / Bronze

- Σώμα από αστάλι / Steel body.
- Ματ πυρίμαχο γυαλί / Fire-resistant matt glass.
- Ντουί / Lampholder G4.

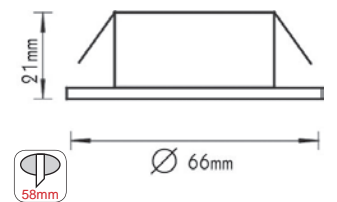

AC.045XFPW



AC.045XFPN



AC.045XFPG



BS812GM



BS812GAB



Χωνευτά σποτ / Recessed spot luminaires G4



BS125FDNM

BS125FENM

12V | G4 max. 20W

***BS125FDNM**

***BS125FENM**

***AC.6001SWC**

***AC.6003WC**

***AC.6012WC**



AC.6001SWC

AC.6003WC

- Σώμα από ατσάλι / Steel body.
- Διάφανο γυαλί με φινιρίσμα αμμοβολής στο χώρο του λαμπτήρα / Clear glass with sand blast in the lamp area.
- Ντουί / Lampholder G4.

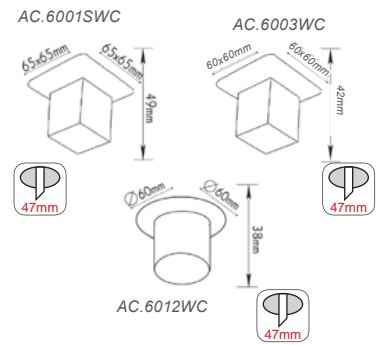
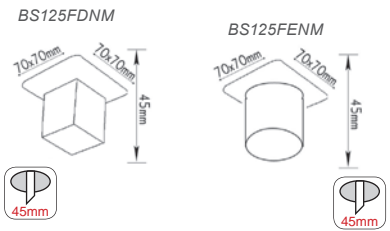

AC.6012WC



Χωνευτά στρογγυλά σποτ / Recessed round spot luminaires G4



SD8016T4G4

12V | G4 max. 20W

***SD8016T4G4 92 x 64mm**

- Σώμα από ατσάλι και γυαλί / Steel and glass body.
- Ντουί / Lampholder G4.



Χωνευτά στρογγυλά σποτ / Recessed round spot luminaires GU5.3 MR16 - GU10



S7009

S7226

12V | GU5.3 MR16 max. 50W
230V | GU10 max. 50W

S7009 82mm x 375mm

S7226 90mm x 230mm

- Σώμα από ατσάλι / Steel body.
- Κρύσταλλοι γυαλιού / Glass crystals.
- Ντουί / Lampholder GU5.3 MR16 - GU10.



Χωνευτά στρογγυλά σποτ / Recessed round spot luminaires G9 - G4



BS92CNMCPWG9

230V | G9 max. 50W

*BS92CNMCPWG9

- Σώμα από ατσάλι / Steel body.
- Ματ γυαλί / Matt glass.
- Ντουί / Lampholder G9.

ΝΙΚΕΛ ΜΑΤ
NICKEL MATT

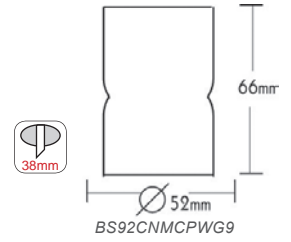

XM2708AB

12V | G4 max. 20W

*XM2708AB

- Σώμα από ατσάλι και γυαλί / Steel and glass body.
- Ντουί / Lampholder G4.

ΛΕΥΚΟ
WHITE

ΜΠΛΕ
BLUE

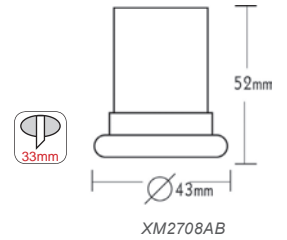

Χωνευτά στρογγυλά σποτ / Recessed round spot luminaires GU5.3 MR16 - GU10



AC.0452711

12V | GU5.3 MR16 max. 50W
230V | GU10 max. 50W

*AC.0452711 Μπλε γυαλί / Blue glass

*AC.0452781 Κίτρινο γυαλί / Yellow glass

*AC.0452731 Μπλε γυαλί / Blue glass

XM27311621W Λευκό γυαλί / White glass

XM27311621B Μπλε γυαλί / Blue glass



AC.0452731



AC.0452781



XM27311621B



XM27311621W

ΛΕΥΚΟ
WHITE

ΜΠΛΕ
BLUE

ΚΙΤΡΙΝΟ
YELLOW

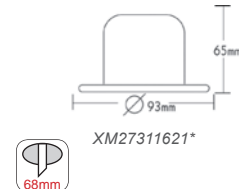
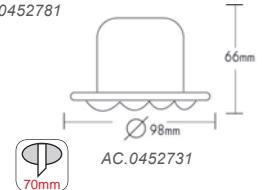
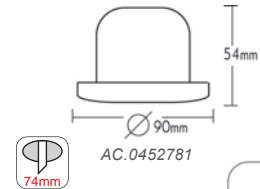
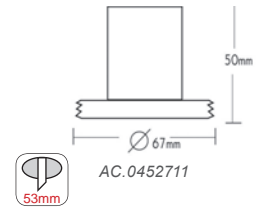

BS3181NMB



BS3181NMW

12V | GU5.3 MR16 max. 50W
230V | GU10 max. 50W

*BS3181NMW Νικελ ματ με διαφανές γυαλί /
Nickel matt with clear glass

*BS3181NMB Νικελ ματ με μπλε γυαλί /
Nickel matt with blue glass

*BS3181GMW Χρυσό ματ διαφανές γυαλί /
Matt gold with clear glass

*BS3181GMB Χρυσό ματ με μπλε γυαλί /
Matt gold with blue glass

ΝΙΚΕΛ/ΜΑΤ
NICKEL/MATT

ΧΡΥΣΟ/ΜΑΤ
GOLD/MATT

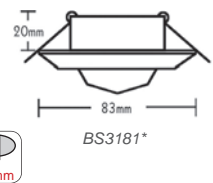

- Σώμα από αλουμίνιο / Aluminum body.
- Κυρτό γυαλί με φυσαλίδες / Curved glass with bubbles.
- Ντουί / Lampholder GU5.3 MR16 - GU10.

Χωνευτά τετράγωνα σποτ / Recessed square spot luminaires GU5.3 MR16 - GU10



XM2707NMW

12V | GU5.3 MR16 max. 50W
230V | GU10 max. 50W

***XM2707NMW** Νίκελ ματ / Nickel matt

***XM2707GMW** Χρυσό ματ / Matt gold

***XM2707GABW** Μπρονζέ / Bronze

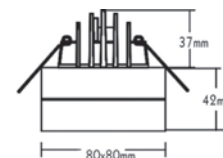

XFWL1A



XFWL2A

12V | GU5.3 MR16 max. 50W
230V | GU10 max. 50W

***XFWL1A** Νίκελ ματ / Nickel matt

***XFWL2A** Νίκελ ματ / Nickel matt

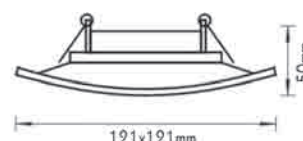

- Σώμα αλουμινίου / Aluminum body.
- Ματ πυρίμαχο γυαλί / Fire-resistant matt glass.
- Ντουί / Lampholder GU5.3 MR16.

Χωνευτά σποτ κρυστάλλου / Recessed crystal spot luminaires GU10



MQ613051A



230V | GU10 max. 50W

***MQ613051A**

- Σώμα μεταλλικού καθρέπτη / Metal mirror body.
- Κρύσταλλο υψηλής διαύγειας / High purity crystal.
- Ντουί / Lampholder GU10.

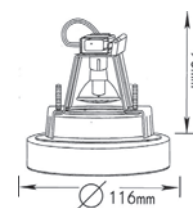

Χωνευτά τετράγωνα σποτ κρυστάλλου / Recessed square crystal spot luminaires GU5.3 MR16 - GU10



MQ513021A



12V | GU5.3 MR16 max. 50W
230V | GU10 max. 50W

***MQ513021A**

- Σώμα αλουμινίου / Aluminum body.
- Κρύσταλλο υψηλής διαύγειας / High purity crystal.
- Συμπεριλαμβάνεται Μ/Σ και λαμπτήρας OSRAM / Included transformer and OSRAM lamp.
- Ντουί / Lampholder GU5.3 MR16 - GU10.

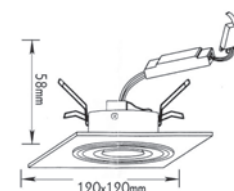

Χωνευτά στρογγυλά σποτ κρυστάλλου / Recessed round crystal spot luminaires G4 - MR11



MQ613021D



12V | G4 max. 20W - MR11 max. 35W

***MQ613021D**

- Σώμα αλουμινίου / Aluminum body.
- Κρύσταλλο υψηλής διαύγειας / High purity crystal.
- Συμπεριλαμβάνεται Μ/Σ και λαμπτήρας OSRAM / Included transformer and OSRAM lamp.
- Ντουί / Lampholder G4 - MR11.

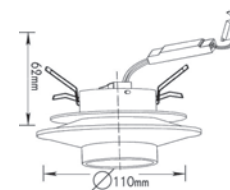

Χωνευτά σποτ διαδρόμων / Recessed corridor spot luminaires G4



BS820NM

12V | G4 max. 20W

*BS823NM Νίκελ ματ / Nickel matt

*BS820NM Νίκελ ματ / Nickel matt

*BS820GM Χρυσό ματ / Matt gold

*BS820GAB Μπρονζέ / Bronze

*BS3122NM Νίκελ ματ / Nickel matt



BS820NM



BS823NM

- Σώμα από αστάλι / Steel body.
- Πυρίμαχο ματ ή πλέγμα γυαλί / Fire-resistant matt or grid glass.
- Ντουί / Lampholder G4.

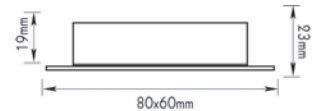

BS823NM



BS3122NM

ΝΙΚΕΛ/ΜΑΤ
NICKEL/MATT



ΧΡΥΣΟ ΜΑΤ
GOLD MATT



ΜΠΡΟΝΖΕ
BRONZE

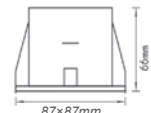

BS3122NM



AC.045XFW10D

12V | G4 max. 20W

*AC.045XFW10D

- Σώμα από αστάλι και αλουμίνιο/ Steel and aluminum body.
- Πυρίμαχο ματ γυαλί / Fire-resistant matt glass.
- Ντουί / Lampholder G4.

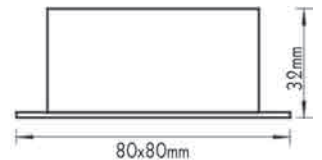

ΓΚΡΙ
GREY



Χωνευτά τετράγωνα σποτ / Recessed square spot luminaires GU10



XFWL4B

230V | GU10 max. 50W

*XFWL4B

- Σώμα χυτού αλουμινίου / Die-casting aluminum body.
- Ματ πυρίμαχο γυαλί / Fire-resistant matt glass.
- Ντουί / Lampholder GU10.

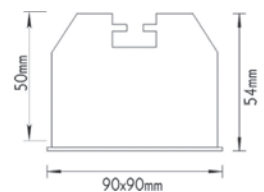

ΓΚΡΙ
GREY



Χωνευτά φωτιστικά κρυφού φωτισμού διαδρόμων / Recessed hidden light corridor luminaires G4



XFWL33

AC.045XFWL56

12V | G4 max. 50W

*XFWL33 12V 50W

*AC.045XFWL56 12V 2x50W

- Σώμα από ασάλι & αλουμίνιο / Steel & aluminum body.
- Ριγωτή φωτιζόμενη επιφάνεια για αποφυγή λαμπρών σημείων & θάμβωσης / Striped illuminated surface to avoid extra bright spots & glare.
- Ντουί / Lampholder G4.

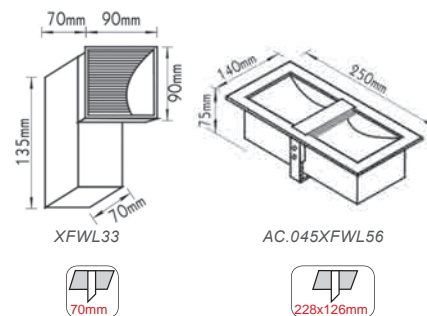

XFWL33

AC.045XFWL56



ΓΚΡΙ
GREY



Χωνευτά φωτιστικά κρυφού φωτισμού διαδρόμων / Recessed hidden light corridor luminaires G9

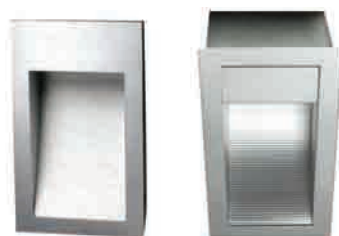

XFWL21AG9

XFWL21G9

230V | G9 max. 50W

*XFWL21AG9

*XFWL21G9

- Σώμα από ασάλι & αλουμίνιο / Steel & aluminum body.
- Ριγωτή φωτιζόμενη επιφάνεια για αποφυγή λαμπρών σημείων & θάμβωσης / Striped illuminated surface to avoid extra bright spots & glare.
- Ντουί / Lampholder G9.

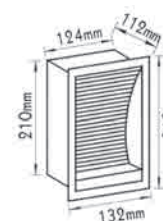

ΓΚΡΙ
GREY



Χωνευτά φωτιστικά κρυφού φωτισμού διαδρόμων / Recessed hidden light corridor luminaires R7s



XFWL35

230V | R7s 78mm max. 100W

*XFWL35

- Σώμα από ασάλι & αλουμίνιο / Steel & aluminum body.
- Ριγωτή φωτιζόμενη επιφάνεια για αποφυγή λαμπρών σημείων & θάμβωσης / Striped illuminated surface to avoid extra bright spots & glare.
- Ντουί / Lampholder R7s 78mm.

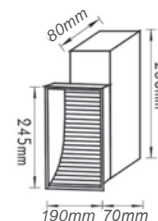

ΓΚΡΙ
GREY



Χωνευτά φωτιστικά ενδεικτικού φωτισμού διαδρόμων / Recessed indicative light corridor luminaires G4



XFWL78JC

XFWL77JC

12V | G4 max. 50W

*XFWL77JC

*XFWL78JC

- Σώμα από ασάλι & αλουμίνιο / Steel & aluminum body.
- Ματ πυρίμαχο γυαλί / Fire-resistant matt glass.
- Ντουί / Lampholder G4.

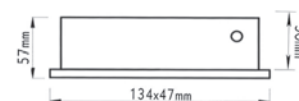

ΓΚΡΙ
GREY



Ηχεία ψευδοροφής / Recessed speakers



EKOW Λευκό / White

EKOB Μαύρο / Black

EKOSG Γκρι βαφής / Grey paint

EKONM Νικελ ματ / Nickel matt

- Σώμα από ασάλι / Steel body.
- Πλέγμα προστασίας / Protection grid.
- Ισχύς / Wattage 30W.

ΛΕΥΚΟ
WHITE



ΜΑΥΡΟ
BLACK



ΓΚΡΙ
GREY

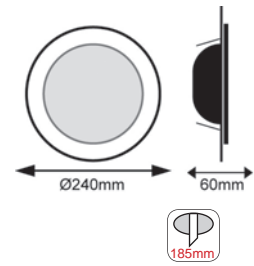

ΝΙΚΕΛ ΜΑΤ
NICKEL MAT

Διάφορα φωτιστικά / Various luminaires

Λόγω αντικατάστασης των Φ/Σ PL και HQI με τα νέας τεχνολογίας LED στον παρών κατάλογο, σας υπενθυμίζουμε διάφορα Φ/Σ που διατίθενται ακόμη με φωτογραφίες και για περισσότερες πληροφορίες επικοινωνήστε με τους πωλητές μας
Due to the replacement of PL and HQI luminaires with the new LED technology in this catalogue, we remind you of several luminaires still available with photos and for more information please contact our sales representatives

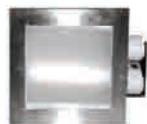

Σε λευκό & Νικελ ματ
In white & Nickel Matte

Σε λευκό & Νικελ ματ
In white & Nickel Matte



Σε όλα τα χρώματα
In all colors

Σε όλα τα χρώματα
In all colors

Σε λευκό & Νικελ ματ
In white & Nickel Matte

Σε λευκό & Νικελ ματ
In white & Nickel Matte

Σε λευκό & Νικελ ματ
In white & Nickel Matte

ΠΡΟΣΟΧΗ: Σε όλα ανεξαιρέτως τα φωτιστικά PL ή HQI, υπάρχει η δυνατότητα τοποθέτησης LED MODULE TRIDONIC.
 Ακόμη και στα παλιά σας φωτιστικά. Με 5ετή εγγύηση
CAUTION: In all PL or HQI luminaires, the MODULE TRIDONIC LED can be installed.
 Even in your old luminaires. With 5 years guarantee

Φωτιστικό οροφής GU10 / Ceiling luminaire GU10 RANGER "A"



RANGER "A" series

- RANGER90RA 90mm**
- RANGER150RA 150mm**
- RANGER200RA 200mm**
- RANGER250RA 250mm**
- RANGER300RA 300mm**
- RANGER350RA 350mm**
- RANGER400RA 400mm**
- RANGER500RA 500mm**
- RANGER600RA 600mm**

- Σώμα αλουμινίου 2mm / Aluminum 2mm body.
- Ηλεκτροστατική βαφή / Electrostatic painting.
- Λεπτός σχεδιασμός / Slim design.
- Ντου / Lampholder GU10.

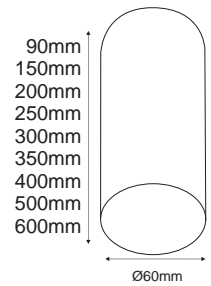

Τοποθετήστε οποιοδήποτε LED Module Ø50 ή λαμπτήρα LED GU10. Place any Ø50 LED Module or LED GU10 lamp.



**Σημείωση: Για βαφή διαφορετικού RAL εσωτερικά και εξωτερικά του φωτιστικού υπάρχει επιβάρυνση .
Για κρεμαστή εγκατάσταση υπάρχει επιβάρυνση .
Notice: For different RAL paint interior and exterior of the luminaire there is extra charge .
For pendant installation there is extra charge .**

Φωτιστικό οροφής GU10 / Ceiling luminaire GU10 RANGER "B"



RANGER "B" series

- RANGER150RB 150mm**
- RANGER200RB 200mm**
- RANGER250RB 250mm**
- RANGER300RB 300mm**
- RANGER350RB 350mm**
- RANGER400RB 400mm**
- RANGER500RB 500mm**
- RANGER600RB 600mm**

- Σώμα αλουμινίου 2mm / Aluminum 2mm body.
- Ηλεκτροστατική βαφή / Electrostatic painting.
- Λεπτός σχεδιασμός / Slim design.
- Ντου / Lampholder GU10.

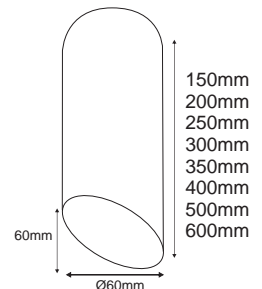













Τοποθετήστε οποιοδήποτε LED Module Ø50 ή λαμπτήρα LED GU10. Place any Ø50 LED Module or LED GU10 lamp.



**Σημείωση: Για βαφή διαφορετικού RAL εσωτερικά και εξωτερικά του φωτιστικού υπάρχει επιβάρυνση .
Για κρεμαστή εγκατάσταση υπάρχει επιβάρυνση .
Notice: For different RAL paint interior and exterior of the luminaire there is extra charge .
For pendant installation there is extra charge .**

Επιλέξτε χρώμα ηλεκτροστατικής βαφής όπως παρατίθενται παρακάτω / Choose electrostatic painting as listed below.

								
ΜΠΛΕ BLUE	ΠΡΑΣΙΝΟ GREEN	ΜΕΝΤΑ MINT	ΚΟΚΚΙΝΟ RED	ΠΟΡΤΟΚΑΛΙ ORANGE	ΚΙΤΡΙΝΟ YELLOW			
								
ΛΕΥΚΟ ΜΑΤ MATT WHITE H / OR ΛΕΥΚΟ ΓΥΑΛ. GLOSS WHITE	ΜΑΥΡΟ ΜΑΤ MATT BLACK H / OR ΜΑΥΡΟ ΓΥΑΛ. GLOSS BLACK	ΛΕΥΚΟ/WHITE RAFAELO	ΜΑΥΡΟ/BLACK RAFAELO	ΓΚΡΙ GREY	ΧΡΩΜΙΟ CHROME	ΜΑΥΡΟ ΧΡΩΜΙΟ BLACK CHROME	ΜΠΡΟΝΖΕ BRONZE	ΟΡΕΙΧΑΛΚΟΣ BRASS

Φωτιστικό οροφής / Ceiling luminaire **ROMEA "A"**



ROMEA "A" series

- ROMEA50RA** 50mm GX53
- ROMEA100RA** 100mm GU10
- ROMEA150RA** 150mm GU10-E27
- ROMEA200RA** 200mm GU10-E27
- ROMEA250RA** 250mm GU10-E27
- ROMEA300RA** 300mm GU10-E27
- ROMEA350RA** 350mm GU10-E27
- ROMEA400RA** 400mm GU10-E27
- ROMEA500RA** 500mm GU10-E27
- ROMEA600RA** 600mm GU10-E27

- Σώμα αλουμινίου 2mm / Aluminum 2mm body.
- Ηλεκτροστατική βαφή / Electrostatic painting.
- Λεπτός σχεδιασμός / Slim design.
- Ντουί / Lampholder E27-GU10.

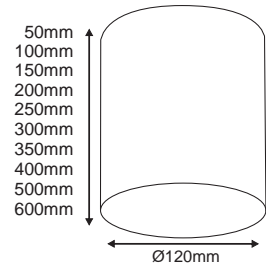

Τοποθετείστε LED Module ή λαμπτήρα LED GX53-AR111-GU10-PAR30. Place LED Module or LED lamp GX53-AR111-GU10-PAR30.



**Σημείωση: Για βαφή διαφορετικού RAL εσωτερικά και εξωτερικά του φωτιστικού υπάρχει επιβάρυνση .
 Για κρεμαστή εγκατάσταση υπάρχει επιβάρυνση .
 Notice: For different RAL paint interior and exterior of the luminaire there is extra charge .
 For pendant installation there is extra charge .**

Φωτιστικό οροφής / Ceiling luminaire **ROMEA "B"**



ROMEA "B" series

- ROMEA150RB** 150mm GX53
- ROMEA250RB** 250mm GU10-E27
- ROMEA300RB** 300mm GU10-E27
- ROMEA350RB** 350mm GU10-E27
- ROMEA400RB** 400mm GU10-E27
- ROMEA500RB** 500mm GU10-E27
- ROMEA600RB** 600mm GU10-E27

- Σώμα αλουμινίου 2mm / Aluminum 2mm body.
- Ηλεκτροστατική βαφή / Electrostatic painting.
- Λεπτός σχεδιασμός / Slim design.
- Ντουί / Lampholder GX53-GU10-E27.

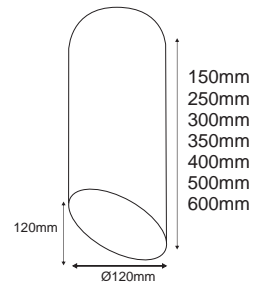

Τοποθετείστε LED Module ή λαμπτήρα LED GX53-AR111-GU10-PAR30. Place LED Module or LED lamp GX53-AR111-GU10-PAR30.



**Σημείωση: Για βαφή διαφορετικού RAL εσωτερικά και εξωτερικά του φωτιστικού υπάρχει επιβάρυνση .
 Για κρεμαστή εγκατάσταση υπάρχει επιβάρυνση .
 Notice: For different RAL paint interior and exterior of the luminaire there is extra charge .
 For pendant installation there is extra charge .**

Επιλέξτε χρώμα ηλεκτροστατικής βαφής όπως παρατίθενται παρακάτω / Choose electrostatic painting as listed below.

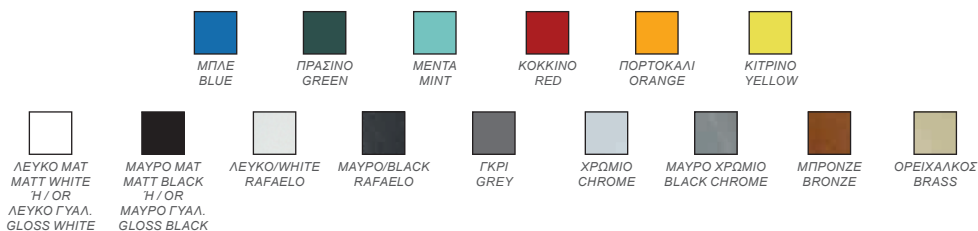

Φωτιστικό οροφής GU10 mini / Ceiling luminaire GU10 mini RENO "A"



RENO "A" series

- RENO90SA 90mm**
- RENO150SA 150mm**
- RENO200SA 200mm**
- RENO250SA 250mm**
- RENO300SA 300mm**
- RENO350SA 350mm**
- RENO400SA 400mm**
- RENO500SA 500mm**
- RENO600SA 600mm**

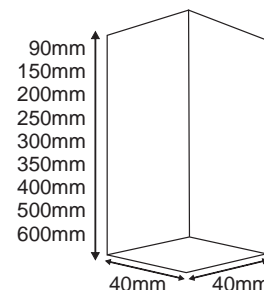

Τοποθετείστε λαμπτήρα LED Mini Ø35 GU10. Place LED lamp Mini Ø35 GU10.



- Σώμα σιδήρου 2mm / Steel 2mm body.
- Ηλεκτροστατική βαφή / Electrostatic painting.
- Λεπτός σχεδιασμός / Slim design.
- Ντουί / Lampholder GU10.

**Σημείωση: Για βαφή διαφορετικού RAL εσωτερικά και εξωτερικά του φωτιστικού υπάρχει επιβάρυνση .
 Για κρεμαστή εγκατάσταση υπάρχει επιβάρυνση .
 Notice: For different RAL paint interior and exterior of the luminaire there is extra charge .
 For pendant installation there is extra charge .**

Φωτιστικό οροφής GU10 / Ceiling luminaire GU10 RENO "B"



RENO "B" series

- RENO90SB 90mm**
- RENO150SB 150mm**
- RENO200SB 200mm**
- RENO250SB 250mm**
- RENO300SB 300mm**
- RENO350SB 350mm**
- RENO400SB 400mm**
- RENO500SB 500mm**
- RENO600SB 600mm**

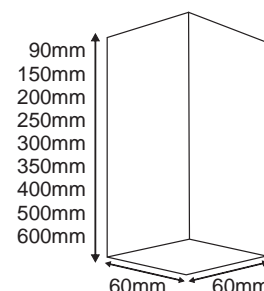

Τοποθετείστε οποιοδήποτε LED Module Ø50 ή λαμπτήρα LED GU10. Place any Ø50 LED Module or LED GU10 lamp.

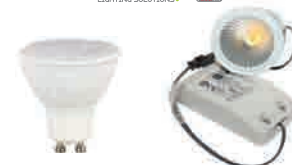

- Σώμα σιδήρου 2mm / Steel 2mm body.
- Ηλεκτροστατική βαφή / Electrostatic painting.
- Λεπτός σχεδιασμός / Slim design.
- Ντουί / Lampholder GU10.

**Σημείωση: Για βαφή διαφορετικού RAL εσωτερικά και εξωτερικά του φωτιστικού υπάρχει επιβάρυνση .
 Για κρεμαστή εγκατάσταση υπάρχει επιβάρυνση .
 Notice: For different RAL paint interior and exterior of the luminaire there is extra charge .
 For pendant installation there is extra charge .**

Επιλέξτε χρώμα ηλεκτροστατικής βαφής όπως παρατίθενται παρακάτω / Choose electrostatic painting as listed below.

ΛΕΥΚΟ ΜΑΤ MATT WHITE H/OR	ΜΑΥΡΟ ΜΑΤ MATT BLACK H/OR	ΛΕΥΚΟ/ΓΥΑΛ. RAFAELO	ΜΑΥΡΟ/ΓΥΑΛ. RAFAELO	ΓΚΡΙ GREY	ΧΡΩΜΙΟ CHROME	ΜΑΥΡΟ ΧΡΩΜΙΟ BLACK CHROME	ΜΠΡΟΝΖΕ BRONZE	ΟΡΕΙΧΑΛΚΟΣ BRASS
ΛΕΥΚΟ ΓΥΑΛ. GLOSS WHITE	ΜΑΥΡΟ ΓΥΑΛ. GLOSS BLACK							

Φωτιστικό οροφής E27-GU10 / Ceiling luminaire E27-GU10 RENO "C"



RENO "C" series

RENO150SC 150mm

RENO200SC 200mm

RENO250SC 250mm

RENO300SC 300mm

RENO350SC 350mm

RENO400SC 400mm

RENO500SC 500mm

RENO600SC 600mm

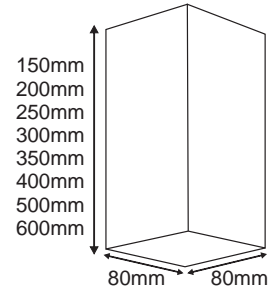

Τοποθετείστε οποιοδήποτε LED Module Ø50, λαμπτήρα LED GU10 ή R63. Place any Ø50 LED Module, LED GU10 or R63 lamp.

- Σώμα σιδήρου 2mm / Steel 2mm body.
- Ηλεκτροστατική βαφή / Electrostatic painting.
- Λεπτός σχεδιασμός / Slim design.
- Ντουί / Lampholder GU10-E27.



Σημείωση: Για βαφή διαφορετικού RAL εσωτερικά και εξωτερικά του φωτιστικού υπάρχει επιβάρυνση +4.00€ netto. Για κρεμαστή εγκατάσταση υπάρχει επιβάρυνση +10.00€ netto. Notice: For different RAL paint interior and exterior of the luminaire there is extra charge +4.00€ netto. For pendant installation there is extra charge +10.00€ netto

Φωτιστικό οροφής / Ceiling luminaire RENO "D"



RENO "D" series

RENO50SD 50mm GX53

RENO100SD 100mm GU10

RENO150SD 150mm GU10-E27

RENO200SD 200mm GU10-E27

RENO250SD 250mm GU10-E27

RENO300SD 300mm GU10-E27

RENO350SD 350mm GU10-E27

RENO400SD 400mm GU10-E27

RENO500SD 500mm GU10-E27

RENO600SD 600mm GU10-E27

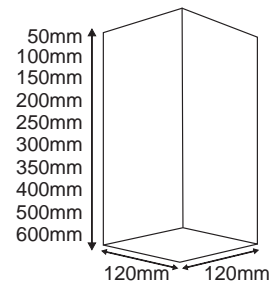

Τοποθετείστε LED Module ή λαμπτήρα LED GX53-AR111-GU10-PAR30. Place LED Module or LED lamp GX53-AR111-GU10-PAR30.

- Σώμα σιδήρου 3mm / Steel 3mm body.
- Ηλεκτροστατική βαφή / Electrostatic painting.
- Λεπτός σχεδιασμός / Slim design.
- Ντουί / Lampholder GX53-GU10-E27.



Σημείωση: Για βαφή διαφορετικού RAL εσωτερικά και εξωτερικά του φωτιστικού υπάρχει επιβάρυνση. Για κρεμαστή εγκατάσταση υπάρχει επιβάρυνση. Notice: For different RAL paint interior and exterior of the luminaire there is extra charge. For pendant installation there is extra charge.

Επιλέξτε χρώμα ηλεκτροστατικής βαφής όπως παρατίθενται παρακάτω / Choose electrostatic painting as listed below.

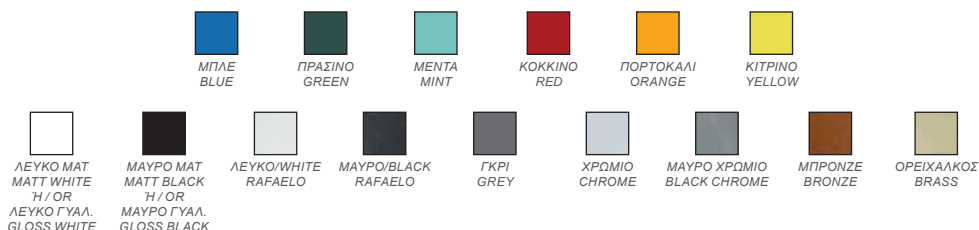

Επίτοιχο σποτ / Wall spot luminaire G4 NIMM



BS805NM



BS805GM

BS805W Λευκό / White

BS805NM Νίκελ ματ / Nickel matt

BS805GM Χρυσό ματ / Matt gold

BS805GAB Μπρονζέ / Bronze

- Σώμα από αστάλι / Steel body.
- Πυρίμαχο διαφανές γυαλί / Fire-resistant clear glass.
- Ντουί / Lampholder G4.

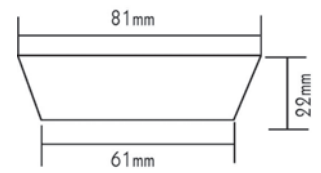

Επίτοιχο σποτ / Wall spot luminaire G4 TRIAN



AC.045BS812S



BS812S1NMS

***AC.045BS812S** Χωρίς διακόπτη / Without switch

***BS812S1NMS** Με διακόπτη / With switch

- Σώμα από αστάλι / Steel body.
- Πυρίμαχο ματ γυαλί / Fire-resistant matt glass.
- Ντουί / Lampholder G4.

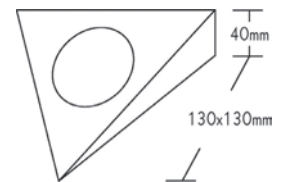

Σποτ οροφής / Ceiling spot luminaire G4 VERAS



XF9014

***XF9014**

- Σώμα χυτού αλουμινίου / Die-casting aluminum body.
- Ματ γυαλί / Matt glass.
- Ντουί / Lampholder G4.

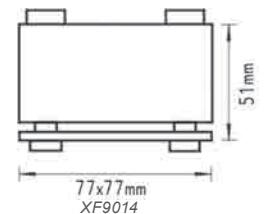

Δεν συμπεριλαμβάνεται μετασχηματιστής 12V / Ballast 12V is not included

Απλικά αρχιτεκτονικού φωτισμού / Architectural wall luminaire G9 BIMY



BS92353SG

***BS92353SG**

- Σώμα αλουμινίου / Aluminum body.
- Πολλαπλές δέσμες / Multiple beams.
- Ντουί / Lampholder G9.

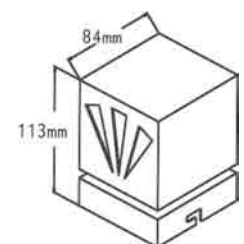

BS92353SG

Απλικά μονής & διπλής δέσμης / Single and up-down beam wall luminaire G9 REZO

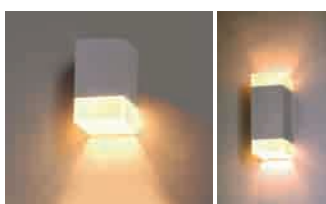

BS9215GSG

BS9216GSG

***BS9215GSG**

***BS9216GSG**

- Σώμα χυτού αλουμινίου / Die-casting aluminum body.
- Ματ γυαλί / Matt glass.
- Ντουί / Lampholder G9.

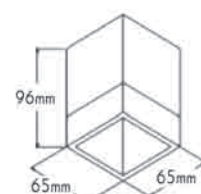

BS9215GSG

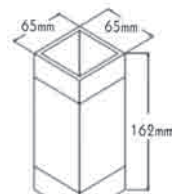

BS9216GSG

**Υπό κατάργηση / Under abolition*

Απλικά / Wall luminaire G9 ZELKO



***BS9252NMCP** Μονής δέσμης / Single beam

***BS92RNMCPWG9** Διπλής δέσμης / Up-down beam

- Σώμα από αστάλι / Steel body.
- Πυρίμαχο ματ γυαλί / Fire-resistant matt glass.
- Ντουί / Lampholder G9.

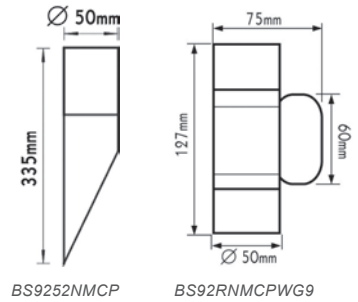

Απλικά αρχιτεκτονικού φωτισμού / Architectural wall luminaire G9 ABAS

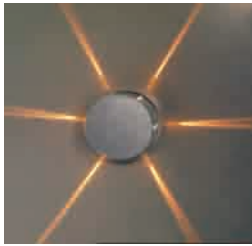

BS92186SG

***BS92186SG**

- Σώμα από αστάλι / Steel body.
- 6 δέσμες κυκλικής διάταξης 2° / 6 beams circular arrangement 2°.
- Ντουί / Lampholder G9.

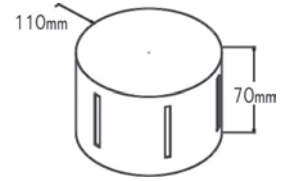

Απλικά αρχιτεκτονικού φωτισμού / Architectural wall luminaire G9 ALASTAR

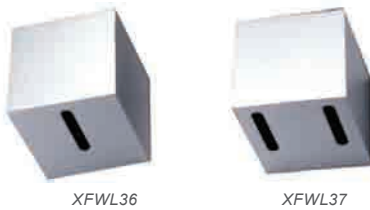

XFWL36

XFWL37

***XFWL36**

***XFWL37**

***XFWL38**

***XFWL37BG9**

***XFWL36BG9**



XFWL38

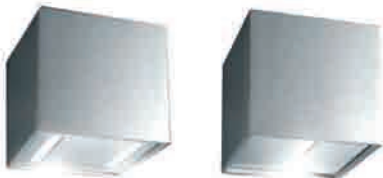

XFWL37BG9

XFWL36BG9

- Σώμα χυτού αλουμινίου / Die-casting aluminum body.
- Δέσμες πολλαπλών επιλογών / Multiple choice beams.
- Ντουί / Lampholder G9.

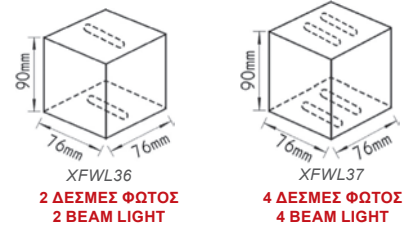

XFWL36
2 ΔΕΣΜΕΣ ΦΩΤΟΣ
2 BEAM LIGHT

XFWL37
4 ΔΕΣΜΕΣ ΦΩΤΟΣ
4 BEAM LIGHT

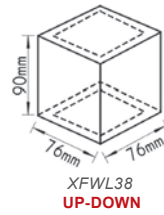

XFWL38
UP-DOWN

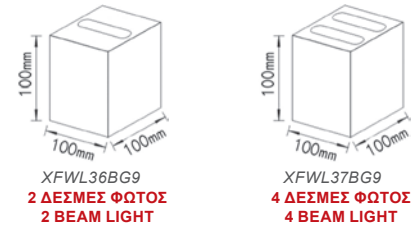

XFWL36BG9
2 ΔΕΣΜΕΣ ΦΩΤΟΣ
2 BEAM LIGHT

XFWL37BG9
4 ΔΕΣΜΕΣ ΦΩΤΟΣ
4 BEAM LIGHT

Απλικά / Wall luminaire R7s COEB



AC.045XFWL48

***AC.045XFWL48** L:118mm

- Σώμα από αστάλι / Steel body.
- Λεπτομέρειες αλουμινίου / Aluminum details.
- Πυρίμαχο ματ γυαλί / Fire-resistant matt glass.
- Ντουί / Lampholder R7s 118mm.

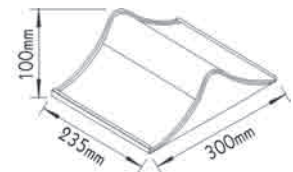

Απλικά μονής δέσμης / Single beam wall luminaire G9



AC.045XFWL30

AC.045XFWL31

***AC.045XFWL30 2 x G9**

***AC.045XFWL31 2 x G9**

- Σώμα χυτού αλουμινίου / Die-casting aluminum body.
- Μονής κατεύθυνσης δέσμη / Single direction lighting beam.
- Ντουί / Lampholder G9.

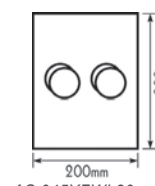

AC.045XFWL30

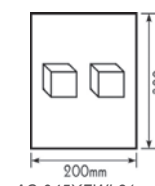

AC.045XFWL31

ΓΚΡΙ
GREY

Απλικά 2 δέσεων έμμεσου φωτισμού / Up-down beam wall indirect luminaire R7s



AC.045XFWL25

AC.045XFWL26

***AC.045XFWL25 L: 118mm**

***AC.045XFWL26 L: 78mm**

- Σώμα χυτού αλουμινίου / Die-casting aluminum body.
- Ντουί / Lampholder R7s 78-118mm.

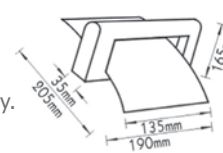

AC.045XFWL25

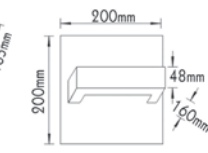

AC.045XFWL26



AC.045XFWL40

AC.045XFWL39

***AC.045XFWL39 1 x G9**

***AC.045XFWL40 2 x G9**

- Σώμα χυτού αλουμινίου / Die-casting aluminum body.
- Ριγωτή επιφάνεια φωτισμού για αποφυγή θάμβωσης / Grid lighting surface to avoid glare.
- Ντουί / Lampholder G9.

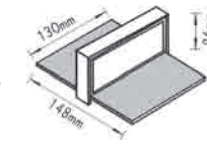

AC.045XFWL40

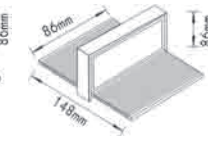

AC.045XFWL39

ΓΚΡΙ
GREY

Περιστρεφόμενη απλικά / Rotating wall luminaire R7s - G5



XFWL44

XFWL44A

***XFWL44 R7s L: 78mm**

***XFWL44A T5 8W με μπάλαστ / with ballast**

- Σώμα χυτού αλουμινίου / Die-casting aluminum body.
- Πυρίμαχο ματ γυαλί / Fire-resistant matt glass.
- Ρυθμιζόμενη γωνία φωτισμού / Adjustable beam angle.
- Ντουί / Lampholder R7s-G5.

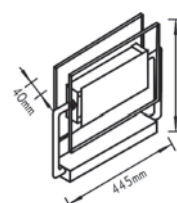

XFWL44A

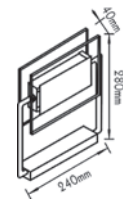

XFWL44

ΓΚΡΙ
GREY

Απλικά / Wall luminaire G9 - T5 - G23



AC.045XFWL28

AC.045XFWL27

***AC.045XFWL27 2xG9**

***AC.045XFWL28 1xT5 14W με μπάλαστ / with ballast**

***AC.045XFWL29 1xT5 21W με μπάλαστ / with ballast**

- Σώμα χυτού αλουμινίου / Die-casting aluminum body.
- Πυρίμαχο ματ γυαλί / Fire-resistant matt glass.
- Ντουί / Lampholder G9-G5 T5.

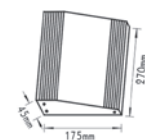

AC.045XFWL27

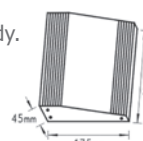

AC.045XFWL28

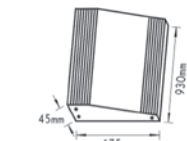

AC.045XFWL29



AC.045XFWL29



XFWL64

XFWL65

***XFWL64 2x9W με μπάλαστ / with ballast**

***XFWL65 1x11W με μπάλαστ / with ballast**

- Σώμα από ατσάλι / Steel body.
- Πλαστικό ακρυλικό κάλυμμα / Plastic acrylic cover.
- Ντουί / Lampholder G23.

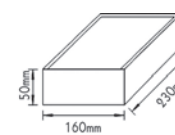

XFWL64

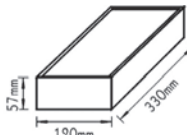

XFWL65

ΓΚΡΙ
GREY

***Υπό κατάργηση / Under abolition**

Απλικά / Wall luminaire E27 - GY6.35



AC.045XFWL8

AC.045XFWL7

***AC.045XFWL7**

***AC.045XFWL8**

- Σώμα από ατσάλι / Steel body.
- Ματ γυαλί / Matt glass.
- Ντουί / Lampholder E27.

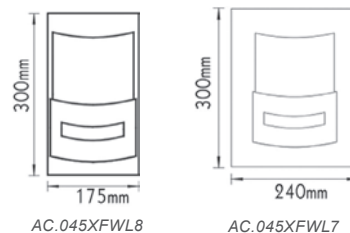

AC.045XFWL8

AC.045XFWL7



XFWL90

***XFWL90 GY6.35 με μπάλαστ / with ballast**

- Σώμα χυτού αλουμινίου / Die-casting aluminum body.
- Πυρίμαχο ματ γυαλί / Fire-resistant matt glass.
- Ντουί / Lampholder GY6.35.

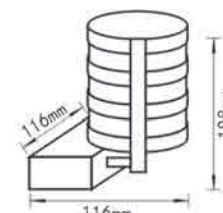

XFWL90

ΓΚΡΙ
GREY



Κρεμαστό σποτ / Pendant spot luminaire GY6.35



XFSP001S

***XFSP001S GY6.35 με μπάλαστ / with ballast**

- Σώμα χυτού αλουμινίου / Die-casting aluminum body.
- Πυρίμαχο ματ γυαλί / Fire-resistant matt glass.
- Ντουί / Lampholder GY6.35.

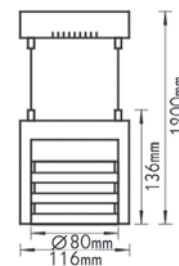

XFSP001S

ΓΚΡΙ
GREY



Απλικά διαδρόμων / Corridor wall luminaire E14



AC.045XF100

AC.045XF100A

***AC.045XF100**

***AC.045XF100A**

- Σώμα χυτού αλουμινίου / Die-casting aluminum body.
- (AC.045XF100) Ματ - διάφανο γυαλί / Matt - clear glass.
- (AC.045XF100A) Κίτρινος πάπυρος / Yellow papyrus.
- Ντουί / Lampholder E14.

ΝΙΚΕΛ ΜΑΤ
NICKEL MATT

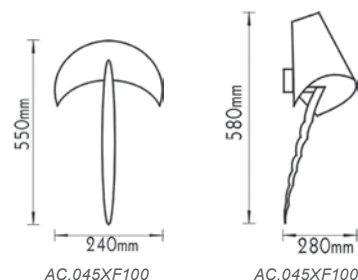

AC.045XF100

AC.045XF100A

Απλικά μονής δέσμης / Single beam wall luminaire GU5.3 MR16 - E14



AC.045XF200

AC.045XF200B

***AC.045XF200 MR16**

***AC.045XF200B E14**

- Σώμα χυτού αλουμινίου / Die-casting aluminum body.
- Ματ γυαλί / Matt glass.
- Ντουί / Lampholder GU5.3 MR16 - E14.

ΓΚΡΙ
GREY

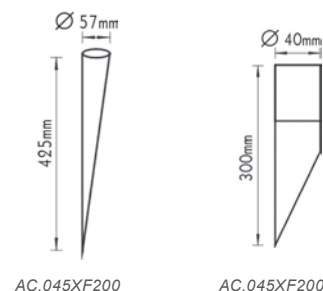

AC.045XF200

AC.045XF200B

Κονσόλες οροφής χαμηλού προφίλ / Ceiling low profile consoles G53 AR111



MC1001G



MC1002G



MC1003G

12V | G53 AR111 max. 100W

MC1001G 1xAR111

MC1002G 2xAR111

MC1003G 3xAR111

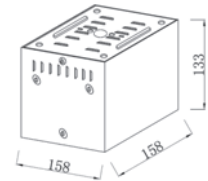

MC1001G

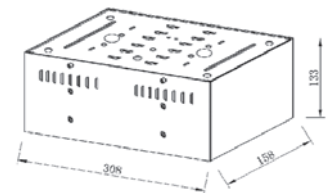

MC1002G

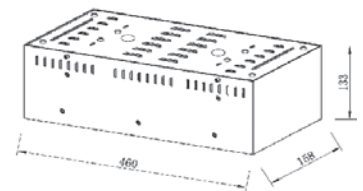

MC1003G

- Σώμα χυτού αλουμινίου / Die-casting aluminum body.
- Ρυθμιζόμενη γωνία φωτισμού / Adjustable lighting beam.
- Κατάλληλο για λαμπτήρες AR111, LED AR111 και LED modules / Suitable for lamps AR111, LED AR111 and LED modules.

ΓΚΡΙ
GREY



Και σε άλλα RAL κατόπιν συνεννόησης
More RAL colors available under demand

Κονσόλες οροφής κενές / Ceiling empty consoles



MC1001BG



MC1002BG



MC1003BG

12V | G53 AR111 max. 100W

MC1001BG Κενή / Empty 1xAR111

MC1002BG Κενή / Empty 2xAR111

MC1003BG Κενή / Empty 3xAR111

- Σώμα χυτού αλουμινίου / Die-casting aluminum body.
- Ρυθμιζόμενη γωνία φωτισμού / Adjustable lighting beam.
- Κατάλληλο για λαμπτήρες AR111, LED AR111 και LED modules / Suitable for lamps AR111, LED AR111 and LED modules.

Σποτ / Spot luminaires

*SDLCDMT Γκρι / Grey G12 - E27

*SDLCDMTN Νίκελ ματ / Nickel matt G12 - E27

*SDLCDMR Γκρι / Grey CDMR - E27

*SDLCDMRN Νίκελ ματ / Nickel matt CDMR - E27

*SDLQR111 Γκρι / Grey AR111

*SDLQR111N Νίκελ ματ / Nickel matt AR111

*SDLCDMR111 Γκρι / Grey CDMR111

*SDLCDMR111N Νίκελ ματ / Nickel matt CDMR111

ΓΚΡΙ
GREY



Και σε άλλα RAL κατόπιν συνεννόησης
More RAL colors available under demand

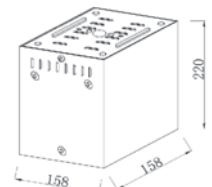

MC1001BG

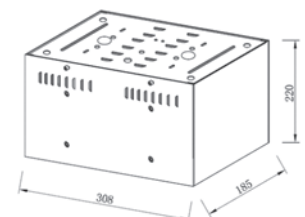

MC1002BG

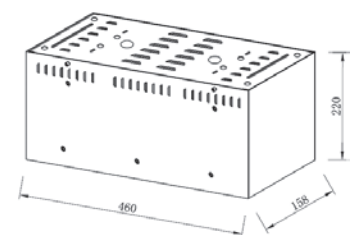

MC1003BG

Χωνευτά κινητά σποτ κρυφού φωτισμού / Trimless recessed movable spot luminaires G53 AR111



Μηδενική θάμβωση
No glare

12V | G53 AR111 max. 100W

GL111W Λευκό / White 1xAR111

GL111B Μαύρο / Black 1xAR111

- Σώμα από αστάλι / Steel body.
- Ρυθμιζόμενη γωνία φωτισμού / Adjustable beam angle.
- Ντουί / Lampholder G53 AR111.

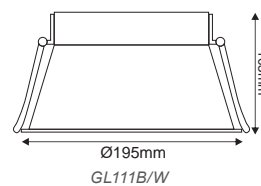

12V | G53 AR111 max. 100W

GL180W Λευκό / White 1xAR111

GL280W Λευκό / White 2xAR111

GL180B Μαύρο / Black 1xAR111

GL280B Μαύρο / Black 2xAR111

- Σώμα από χυτό αλουμίνιο & αστάλι / Die-casting aluminum & steel body.
- Ρυθμιζόμενη γωνία φωτισμού / Adjustable beam angle.
- Ντουί / Lampholder G53 AR111.

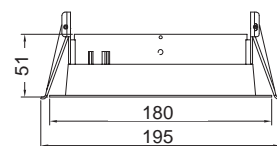

GL180B/W

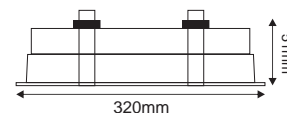

GL280B/W



Τοποθετείστε / Install
LED COB Module 15W 10-60°
ή / or LED SMD Module 30W 120°



ΛΕΥΚΟ
WHITE



ΜΑΥΡΟ
BLACK



Χωνευτές κινητές κονσόλες / Recessed movable consoles G53 AR111 - R7s



12V | G53 AR111 max. 100W

XM2901SNM Νίκελ ματ / Nickel matt 1xAR111

XM2902SNM Νίκελ ματ / Nickel matt 2xAR111

XM2902SW Λευκό / White 2xAR111

XM2902SB Μαύρο / Black 2xAR111

*XM2902S1SG Γκρι / Grey 2xAR111 & 1xR7s 118mm

XM2903SNM Νίκελ ματ / Nickel matt 3xAR111

*XM2904SNM Νίκελ ματ / Nickel matt 4xAR111

*XM2905SSNM Νίκελ ματ / Nickel matt 4xAR111

- Σώμα από χυτό αλουμίνιο & αστάλι / Die-casting aluminum & steel body.
- Ρυθμιζόμενη γωνία φωτισμού / Adjustable lighting beam.
- Ντουί / Lampholder G53 AR111.

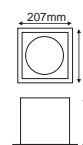

XM2901SNM

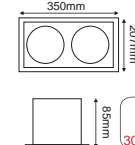

XM2902S*

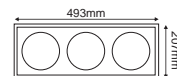

XM2903SNM

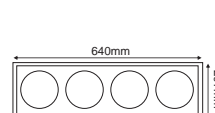

XM2904SNM

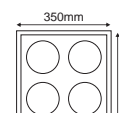

XM2905SSNM



ΛΕΥΚΟ
WHITE



ΜΑΥΡΟ
BLACK



ΓΚΡΙ
GREY



ΝΙΚΕΛ/ΜΑΤ
NICKEL/MATT

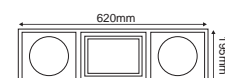

XM2902S1SG

*Υπό κατάργηση / Under abolition

Χωνευτές κινητές κονσόλες / Recessed movable consoles G53 AR111



AC.045XF001B



AC.045XF002B



AC.045XF003B



AC.045XF004R



AC.045XF004B

12V | G53 AR111 max. 100W

AC.045XF001B 1xAR111

AC.045XF002B 2xAR111

AC.045XF003B 3xAR111

AC.045XF004B 4xAR111

AC.045XF004R 4xAR111

- Μεταλλικό σώμα / Metallic body.
- Ρυθμιζόμενη γωνία φωτισμού / Adjustable beam angle.
- Ντουί / Lampholder G53 AR111.

ΓΚΡΙ
GREY

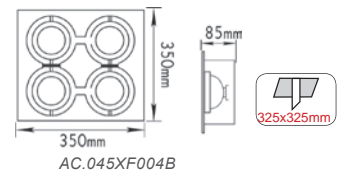
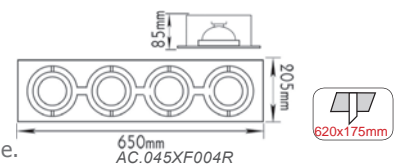
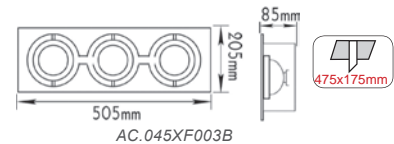
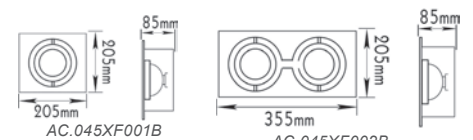

Φίλτρα χρώματος για λαμπτήρες AR111 / Color filters for AR111 lamps



*AC.0979RVI Βιολετί / Violet

*AC.0979RBL Μπλε / Blue

*AC.0979RYE Κίτρινο / Yellow

*AC.0979RRE Κόκκινο / Red

*AC.0979RGR Πράσινο / Green

ΒΙΟΛΕΤΙ
VIOLET



ΜΠΛΕ
BLUE



ΚΙΤΡΙΝΟ
YELLOW



ΚΟΚΚΙΝΟ
RED



ΠΡΑΣΙΝΟ
GREEN

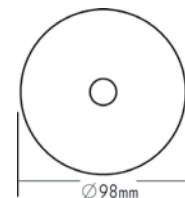

Χωνευτές κινητές κονσόλες κρυφού φωτισμού / Recessed movable hidden light consoles GU5.3 MR16



XF002C



XF003C

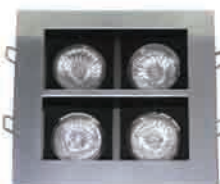

XF004C

12V | GU5.3 MR16 max. 50W

*XF002C 2xMR16

*XF003C 3xMR16

*XF004C 4xMR16

- Σώμα από ασάλι / Steel body.
- Ρυθμιζόμενη γωνία φωτισμού / Adjustable lighting beam.
- Μηδενική θάμβωση / Zero glare.
- Ντουί / Lampholder GU5.3 MR16.



ΓΚΡΙ
GREY

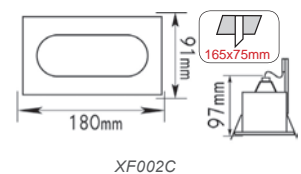

XF002C

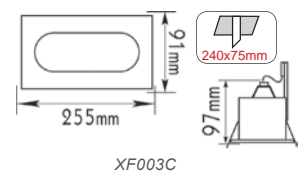

XF003C

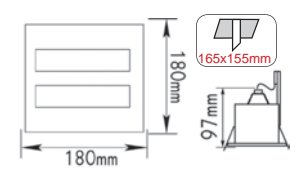

XF004C

*Υπό κατάργηση / Under abolition

Χωνευτές κινητές κονσόλες / Recessed movable consoles GU5.3 MR16 - GU10



BS3601N

12V | GU5.3 MR16 max. 50W
230V | GU10 max. 50W

BS3601N

BS3602N

BS3603N



BS3602N

BS3601

BS3602

BS3603

BS3604



BS3601



BS3602



BS3603



BS3604

- Σώμα αλουμινίου / Aluminum body.
- Ρυθμιζόμενη γωνία φωτισμού / Adjustable lighting beam.
- Ντρουί / Lampholder GU5.3 MR16 - GU10.

ΓΚΡΙ
GREY

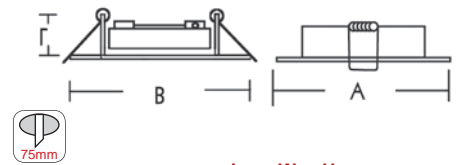

L W H

BS3601N 92 x 92 x 20mm

BS3602N 172 x 92 x 20mm

BS3603N 252 x 92 x 20mm

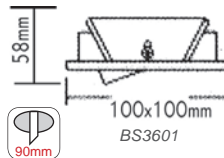

BS3601

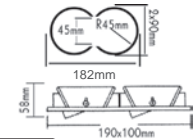

BS3602

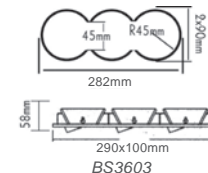

BS3603

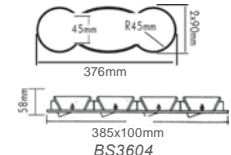

BS3604

Χωνευτές κινητές κονσόλες / Recessed movable consoles GU10



AC.045XF001F

230V | GU10 max. 50W

*AC.045XF001F

*AC.045XF002F

*AC.045XF003F

*AC.045XF004F



AC.045XF002F



AC.045XF003F



AC.045XF004F

- Σώμα από αλουμίνιο & ασάλι / Steel & aluminum body.
- Ρυθμιζόμενη γωνία φωτισμού / Adjustable lighting beam.
- Ντρουί / Lampholder GU10.

ΓΚΡΙ
GREY

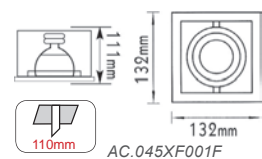

AC.045XF001F

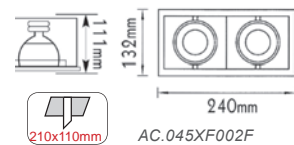

AC.045XF002F

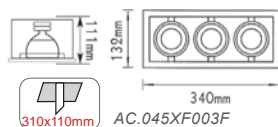

AC.045XF003F

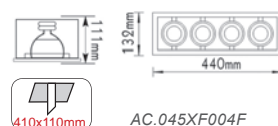

AC.045XF004F

*Υπό κατάργηση / Under abolition

Χωνευτές κινητές κενές κονσόλες και σποτ διαφόρων τύπων /
Recessed movable empty consoles and various spot luminaires



SLDH1001B/N



SLDH1002B/N



SLDH1003B/N



SLDH1004B/N



SLDH1014B/N

Κονσόλες κενές για σποτ
Empty consoles for spot luminaires

***SLDH1001BN** Νίκελ ματ / Nickel matt

***SLDH1001B** Γκρι / Grey

***SLDH1002B** Γκρι / Grey

***SLDH1003B** Γκρι / Grey

***SLDH1003BN** Νίκελ ματ / Nickel matt

***SLDH1004B** Γκρι / Grey

***SLDH1004BN** Νίκελ ματ / Nickel matt

***SLDH1014B** Γκρι / Grey

***SLDH1014BN** Νίκελ ματ / Nickel matt

- Σώμα από χυτό αλουμίνιο & ασάλι / Die-casting aluminum & steel body.
- Ρυθμιζόμενη γωνία φωτισμού / Adjustable beam angle.



SLDH1001B/N

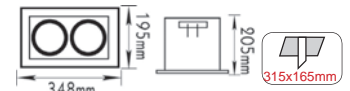

SLDH1002B/N

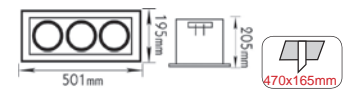

SLDH1003B/N

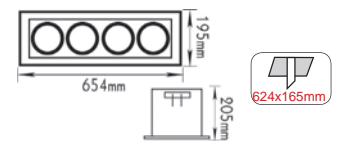

SLDH1004B/N

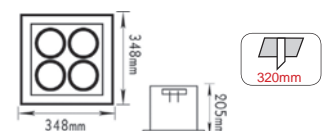

SLDH1014B/N



Σποτ / Spot luminaires

***SDLCDMT** Γκρι / Grey G12 - E27

***SDLCDMTN** Νίκελ ματ / Nickel matt G12- E27

***SDLCDMR** Γκρι / Grey CDMR- E27

***SDLCDMRN** Νίκελ ματ / Nickel matt CDMR- E27

***SDLQR111** Γκρι / Grey AR111

***SDLQR111N** Νίκελ ματ / Nickel matt AR111

***SDLCDMR111** Γκρι / Grey CDMR111

***SDLCDMR111N** Νίκελ ματ / Nickel matt CDMR111



SDLCDMT/N



SDLCDMR/N



SDLQR111/NM



SDLMR111/N



Χωνευτές κενές κονσόλες και σποτ διαφόρων τύπων / Recessed empty consoles and various spot luminaires MULTILIGHT



SDLCB1180FR

SDLCB1180F



SDLCB2180F



SDLCB3180F



SDLCB4180FR



SDLCB4180F

**Κονσόλες κενές για σποτ
Empty consoles for spot luminaires**

SDLCB1180FRW Στρογγυλό λευκό × 1 σποτ /
White round × 1 spot luminaire

SDLCB1180FRB Στρογγυλό μαύρο × 1 σποτ /
Black round × 1 spot luminaire

SDLCB1180FR Στρογγυλό γκρι × 1 σποτ /
Grey round × 1 spot luminaire

SDLCB1180FW Τετράγωνο λευκό × 1 σποτ /
White square × 1 spot luminaire

SDLCB1180F Τετράγωνο γκρι × 1 σποτ / Grey
square × 1 spot luminaire

SDLCB2180FW Λευκό × 2 σποτ /
White × 2 spot luminaires

SDLCB2180F Γκρι × 2 σποτ /
Grey × 2 spot luminaires

SDLCB3180FW Λευκό × 3 σποτ /
White × 3 spot luminaires

SDLCB3180F Γκρι × 3 σποτ /
Grey × 3 spot luminaires

SDLCB4180F Γκρι × 4 σποτ /
Grey × 4 spot luminaires

SDLCB4180FR Γκρι × 4 σποτ /
Grey × 4 spot luminaires

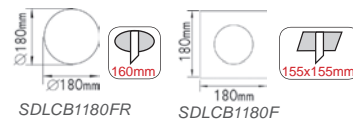

SDLCB1180FR

SDLCB1180F



SDLCB2180F

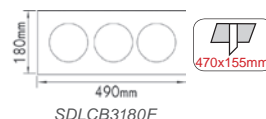

SDLCB3180F

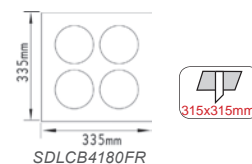

SDLCB4180FR

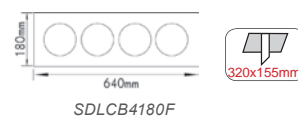

SDLCB4180F

- Σώμα από χυτό αλουμίνιο & ατσάλι / Die-casting aluminum & steel body.
- Ρυθμιζόμενη γωνία φωτισμού / Adjustable beam angle.



CBCDMR

CBCDMT



CBA26

CBQR111 / CDMR111

Σποτ / Spot luminaires

CBCDMRWH Λευκό / White PAR E27 - CDMR

CBCDMR Γκρι / Grey PAR E27 - CDMR

CBCDMTWH Λευκό / White G12-E27

CBCDMT Γκρι / Grey G12-E27

CBA26 Γκρι / Grey PL-1x26W-E27

CBQR111WH Λευκό / White AR111

CBQR111 Γκρι / Grey AR111

CBCDMR111 Γκρι / Grey CDMR111

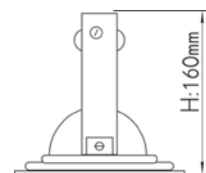

Αυτή η σειρά φωτιστικών συμπεριλαμβάνει 5 διαφορετικές κονσόλες στις οποίες μπορούν να τοποθετηθούν διάφορων ειδών σποτ όπως G12, HQI, CDMR, CDMR111, AR111, E27 PAR30 έτσι ώστε να δημιουργηθεί η σύνθεση της αρεσκείας σας. This series include 5 kind of consoles, where different spots such as G12, HQI, CDMR, CDMR111, AR111, E27 PAR30 can be placed so that all ideas and effects to be completed.

Χωνευτές κενές κονσόλες κρυφού φωτισμού και σποτ διαφόρων τύπων / Recessed hidden light empty consoles and various spot luminaires



SDLFCB1180A



SDLFCB2180A



SDLFCB3180A



SDLFCB4180A

**Κονσόλες κενές για σποτ
Empty consoles for spot luminaires**

SDLFCB1180A 1 σποτ /
1 spot luminaire

SDLFCB2180A 2 σποτ /
2 spot luminaires

SDLFCB3180A 3 σποτ /
3 spot luminaires

SDLFCB4180A 4 σποτ /
4 spot luminaires

Σποτ / Spot luminaires

CBCDMRB E27

CBCDMR111B CDMR111-E27

CBCDMTB E27

CBQR111B AR111

- Σώμα από χυτό αλουμίνιο & ασάλι / Die-casting aluminum & steel body.
- Ρυθμιζόμενη γωνία φωτισμού / Adjustable beam angle.

MAYPO
BLACK



CBCDMRB



CBCDMTB



CBCDMR111B / CBQR111B

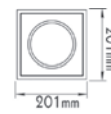

SDLFCB1180A



192x185mm

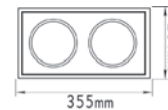

SDLFCB2180A



340x187mm

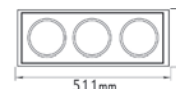

SDLFCB3180A



495x187mm

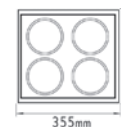

SDLFCB4180A



347x340mm

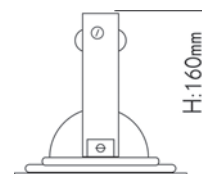

CBCDMRB
CBCDMTB



Και σε άλλα RAL κατόπιν συνηνόησης
More RAL colors available under demand

Χωνευτά κινητά φωτιστικά / Recessed movable luminaires



ME1080TC



ME1080CDMT

*ME1080TCW Λευκό / White G8.5-E27

*ME1080TC Γκρι / Grey G8.5-E27

*ME1080CDMT Νικελ ματ / Nickel matt G12-E27

*ME1080QR111 Γκρι / Grey AR111

*ME1080CDMR Γκρι / Grey E27 - CDMR

- Σώμα από χυτό αλουμίνιο & ασάλι / Die-casting aluminum & steel body.
- Ρυθμιζόμενη γωνία φωτισμού / Adjustable beam angle.



ME1080QR111



ME1080CDMR

ΛΕΥΚΟ
WHITE



ΓΚΡΙ
GREY



ΝΙΚΕΛ ΜΑΤ
NICKEL MATT



ME1080TC

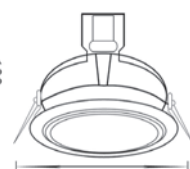

ME1080CDMT

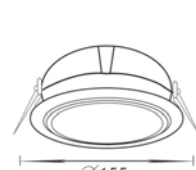

ME1080QR111



ME1080CDMR

Χωρίς σύστημα έναυσης / Without gear box

*Υπό κατάργηση / Under abolition

Χωνευτά κινητά φωτιστικά / Recessed movable luminaires E27



AC.045XF001J

***AC.045XF001J**

***AC.045XF003J**

- Σώμα χυτού αλουμινίου / Die-casting aluminum body.
- Πυρίμαχο διαφανές γυαλί / Clear fire-resistant glass.
- Ρυθμιζόμενη γωνία φωτισμού / Adjustable beam angle.
- Ντουί / Lampholder HQI E27.

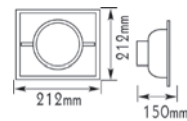

AC.045XF001J



AC.045XF003J

ΓΚΡΙ
GREY

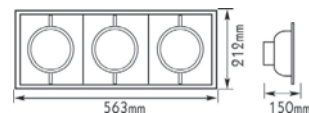

AC.045XF003J



Χωνευτά ρυθμιζόμενα φωτιστικά / Recessed adjustable luminaires G53 AR111



***XM2901PSG**

- Σώμα από χυτό αλουμίνιο & ασάλι / Die-casting aluminum & steel body.
- Σπαστή βάση και κατεύθυνση 360° / Sectional base and 360° direction.
- Ντουί / Lampholder G53 AR111.

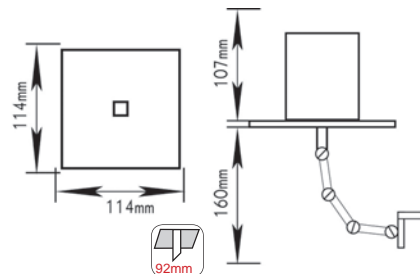

ΓΚΡΙ
GREY



Κρεμαστά φωτιστικά / Pendant luminaires G9



AC.045XFGJ3

***AC.045XFGJ3**

***AC.045XFGJ4S**

- Σώμα από χυτό αλουμίνιο & ασάλι / Die-casting aluminum & steel body.
- Μεταλλικές περσίδες για ιδανική διάχυση φωτισμού / Metal louvers for ideal diffusion lighting.
- Ντουί / Lampholder G9.

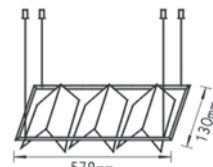

AC.045XFGJ3



AC.045XFGJ4S

ΓΚΡΙ
GREY

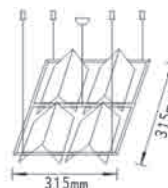

AC.045XFGJ4S

Κρεμαστά φωτιστικά / Pendant luminaires E27



AC.045XF002JB

***AC.045XF004JB**

***AC.045XF002JB**

- Σώμα χυτού αλουμινίου / Die-casting aluminum body.
- Πυρίμαχο διαφανές γυαλί / Clear fire-resistant glass.
- Ρυθμιζόμενη γωνία φωτισμού / Adjustable beam angle.
- Ντουί / Lampholder HQI G12 - E27.

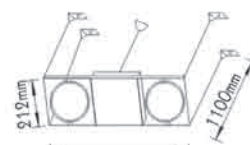

AC.045XF002JB

ΓΚΡΙ
GREY

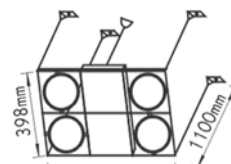

AC.045XF004JB

Χωρίς σύστημα έναυσης / Without gear box

***Υπό κατάργηση / Under abolition**

Επίτοιχα-κρεμαστά φωτιστικά / Ceiling-pendant luminaires G53 AR111



AC.045XF04DR



AC.045XF04DS

*AC.045XF04DR

*AC.045XF04DS

*AC.045XF04GR

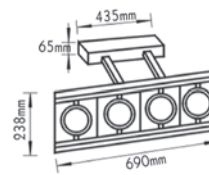

AC.045XF04DR

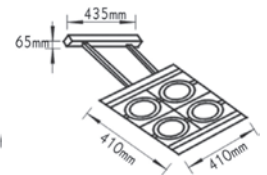

AC.045XF04DS

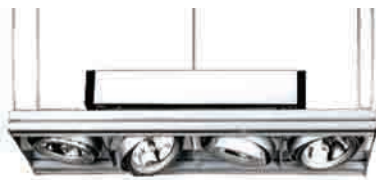

AC.045XF04GR

- Σώμα χυτού αλουμινίου / Die-casting aluminum body.
- Ρυθμιζόμενη γωνία φωτισμού / Adjustable beam angle.
- Ντου / Lampholder G53 AR111.

ΓΚΡΙ
GREY

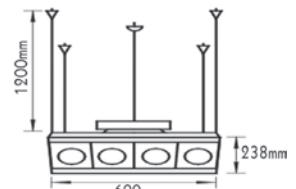

AC.045XF04GR

Πλαίσια & εξαρτήματα για σύστημα PERGOLA / Frames & accessories for PERGOLA system



*DZDIYAL1M W:1m

*DZDIYAL15M W:1,5m

*DZDIYAL2M W:2m

*DZDIYAL3M W:3m

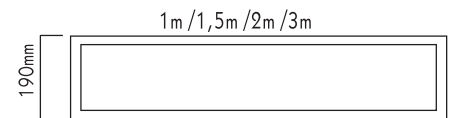

DZDIYL



DZDIYI

*DZDIYL

*DZDIYI

*DZDIYT

*DZDIYX

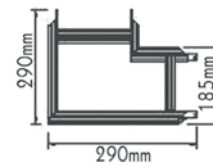

DZDIYL

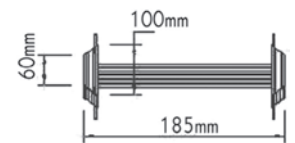

DZDIYI

- Σώμα αλουμινίου / Aluminum body.
- Δυνατότητα οποιασδήποτε σύνθεσης / Possibility of any composition.

ΓΚΡΙ
GREY

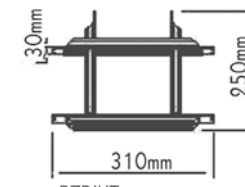

DZDIYT

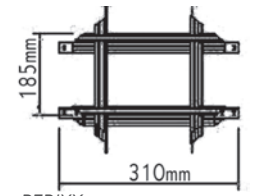

DZDIYX

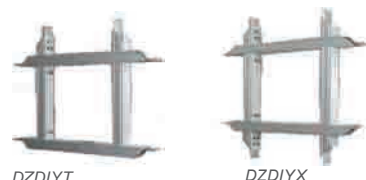

DZDIYT



DZDIYX

*Όλα τα τμήματα μπορούν να σχηματίσουν διαφορετικά σχήματα πλαισίου αλουμινίου
All of the parts can be formed into different shapes of aluminium frame*

Ράγες 2 καλωδίων & εξαρτήματα για σύστημα PERGOLA /
2 cable tracks & accessories for PERGOLA system



DZDIY2MT1M

*DZDIY2MT15M W:1,5m

*DZDIY2MT2M W:2m

*DZDIY2MT3M W:3m

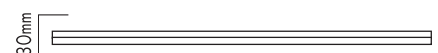

DZDIY2MTT



DZDIY2MTX

*DZDIY2MTT

*DZDIY2MTX

*DZDIY2MTL

*DZDIY2MTI

- Σώμα αλουμινίου / Aluminum body.
- Δυνατότητα οποιασδήποτε σύνθεσης / Possibility of any composition.

ΓΚΡΙ
GREY



DZDIY2MTL



DZDIY2MTI

*Όλα τα τμήματα μπορούν να σχηματίσουν διαφορετικά σχήματα πλαισίου αλουμινίου
All of the parts can be formed into different shapes of aluminium frame*

**Υπό κατάργηση / Under abolition*

Φωτιστικά & σποτ για σύστημα PERGOLA / Luminaires & spot luminaires for PERGOLA system

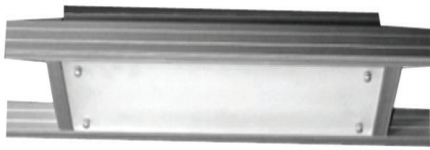

DZDIYT5314W

Με μπάλαστ / With ballast

*DZDIYT5314W 700mm 3x14W

*DZDIYT5321W 981mm 3x21W

*DZDIYT5335W 1580mm 3x35W

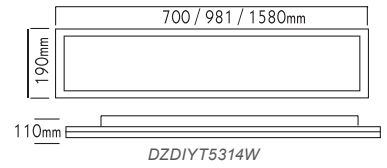

DZDIYT5314W



DZDIYQR111

AR111 χωρίς μπάλαστ / AR111 without ballast

*DZDIYQR111 50W

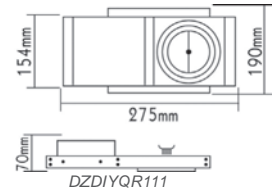

DZDIYQR111



DZDIYCDMT

G12 ή E27 χωρίς μπάλαστ / G12 or E27 without ballast

*DZDIYCDMT 150W

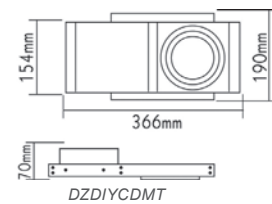

DZDIYCDMT



DZDIYHQI

RX7s χωρίς μπάλαστ / RX7s without ballast

*DZDIYHQI 150W

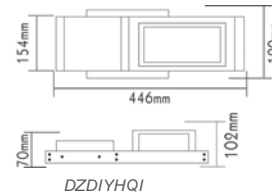

DZDIYHQI



DZDIYCDMR

E27 χωρίς μπάλαστ / E27 without ballast

*DZDIYCDMR E27 PAR30

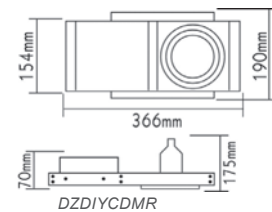

DZDIYCDMR



DZDIYCDMRIII

CDMR111 χωρίς μπάλαστ / CDMR111 without ballast

*DZDIYCDMRIII 35W / 70W

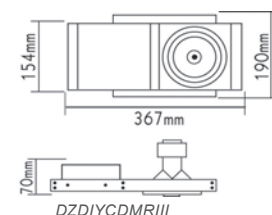

DZDIYCDMRIII



DZDIYAMR16

DZDIYAQRIII

MR16 χωρίς μπάλαστ / MR16 without ballast

*DZDIYAMR16 max 50W

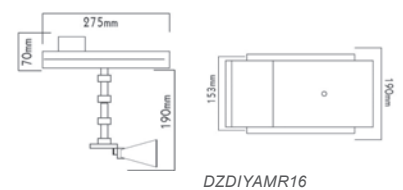

DZDIYAMR16

AR111 χωρίς μπάλαστ / AR111 without ballast

*DZDIYAQRIII max 50W

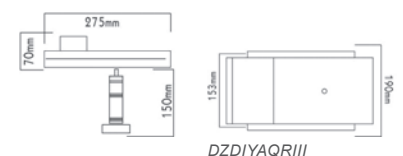

DZDIYAQRIII

ΓΚΡΙ
GREY



*Υπό κατάργηση / Under abolition

www.acalight.gr

Σποτ οροφής / Ceiling spot luminaires E14 R50



AC.04544Y2

AC.04544Y4

230V | E14 R50 max. 40W

***AC.04544Y2**

***AC.04544Y4**

- Σώμα από ασάλι & ξύλο / Steel & wood body.
- Διαφανές γυαλί / Clear glass.
- Ρυθμιζόμενη γωνία φωτισμού / Adjustable beam angle.
- Ντουί / Lampholder E14 R50.

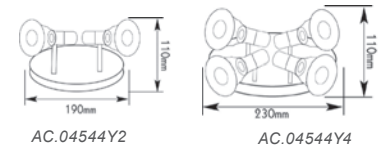

AC.04544Y2

AC.04544Y4

Σποτ οροφής / Ceiling spot luminaires E27 R63



AC.04597Y2

230V | E27 R63 max. 40W

***AC.04597Y2**

***AC.04597Y3**

- Σώμα από ασάλι / Steel body.
- Ρυθμιζόμενη γωνία φωτισμού / Adjustable beam angle.
- Ντουί πορσελάνης / Porcelain lampholder E27 R63.

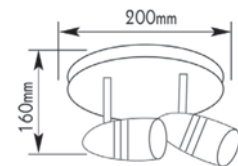

AC.04597Y2

Σποτ οροφής - απλίκες / Ceiling spot luminaires - wall luminaires GU10



SOLAR1WOF

SOLAR1TL1

230V | GU10 max. 50W

***SOLAR1WOF**

***SOLAR1TL1**

- Σώμα από χυτό αλουμίνιο & ασάλι / Die-casting aluminum & steel body.
- Διαφανές γυαλί / Clear glass.
- Ρυθμιζόμενη γωνία φωτισμού / Adjustable beam angle.
- Ντουί / Lampholder GU10.

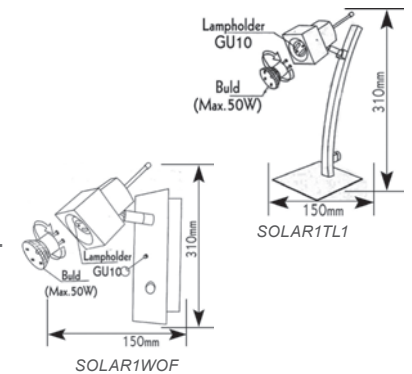

SOLAR1WOF

SOLAR1TL1

Σποτ οροφής - απλίκες - επιτραπέζια φωτιστικά / Ceiling spot luminaires - wall luminaires - table luminaires GU10



V222001TLI



V222003CSI



V222004CSQ

230V | GU10 max. 50W

***V222001TLI**

***V222003CSI**

***V222004CSQ**

- Σώμα από χυτό αλουμίνιο & ασάλι / Die-casting aluminum & steel body.
- Διαφανές γυαλί / Clear glass.
- Ρυθμιζόμενη γωνία φωτισμού / Adjustable beam angle.
- Ντουί / Lampholder GU10.



V222001TLI

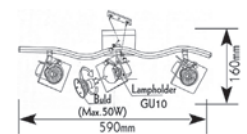

V222003CSI

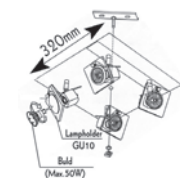

V222004CSQ

Σποτ οροφής - απλικές - επιτραπέζια φωτιστικά - επιδαπέδια φωτιστικά / Ceiling spot luminaires - wall luminaires - table luminaires - floor luminaires G9



V221981W



V221984PAL

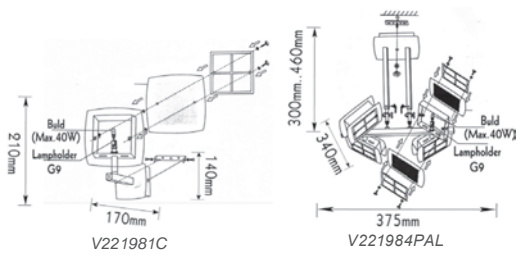

V221986PAL

- 230V | G9 max. 40W**
- *V221981W
 - *V221984PAL
 - *V221986PAL
 - *V221981C
 - *V221982C
 - *V221984C
 - *V221981T
 - *V221983F

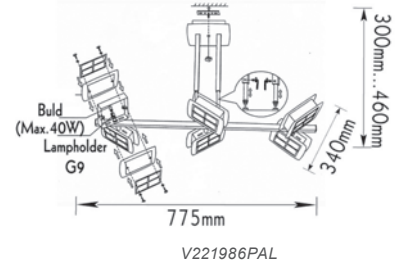

V221982C

- Σώμα από χυτό αλουμίνιο & ατσάλι / Die-casting aluminum & steel body.
- Πυρίμαχο ματ γυαλί / Fire-resistant matt glass.
- Ντουί / Lampholder G9.

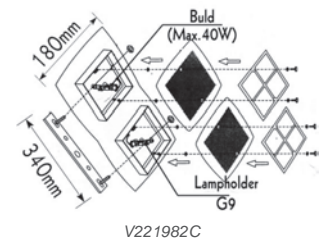

V221983F



V221981C

ΓΚΡΙ
GREY

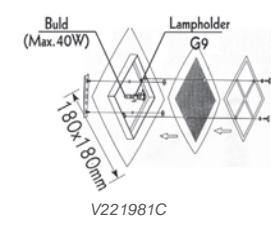

V221984C

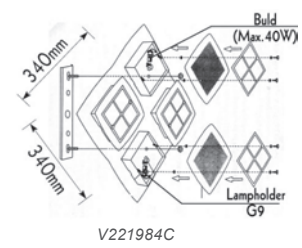

V221981T

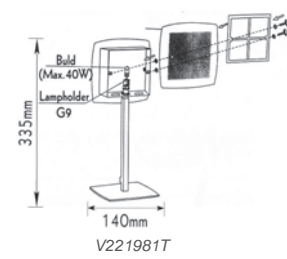

Φωτιστικό / Luminaire PAR36



AC.045008CP

12V | PAR36 max. 50W

AC.045008CWL Κενό λευκό / Empty white

AC.045008CB Κενό μαύρο / Empty black

AC.045008CW Κενό νικελ / Empty nickel

AC.045008CP Νικελ / Nickel 12V

AC.045008B Μαύρο / Black 12V

- Πρεσσαριστό φύλλο αλουμινίου / Pressing aluminum sheet.
- Ρυθμιζόμενος βραχίονας / Adjustable bracket.
- Ρυθμιζόμενη γωνία φωτισμού / Adjustable beam angle.
- Ντου / Lampholder PAR36 12V.

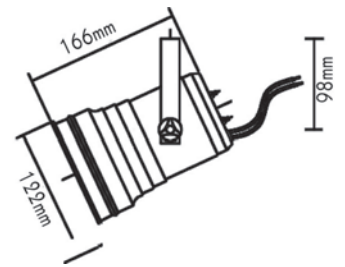

Με ηλεκτρονικό μετασχηματιστή / With electronic ballast

Φωτιστικό / Luminaire PAR30 - PAR56 - PAR64



AC.045XFST3

***AC.045XFST3** PAR30

***AC.045XFST4** PAR56 1x300W

***AC.045XFST5** PAR64 1x1000W

- Σώμα αλουμινίου / Aluminum body.
- Ρυθμιζόμενος βραχίονας / Adjustable bracket.
- Πλέγμα προστασίας / Safety grid.
- Ντου / Lampholder PAR30-PAR56-PAR64.

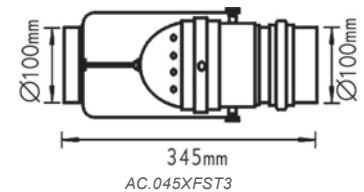

AC.045XFST4

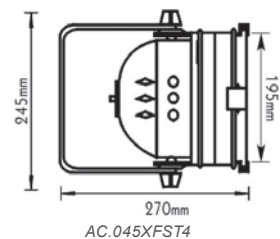

AC.045XFST5

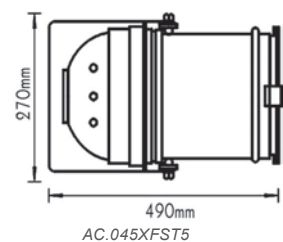

***Υπό κατάργηση / Under abolition**

Φωτιστικό οροφής / Ceiling luminaire PAR30



AC.045XFST6

***AC.045XFST6 PAR30**

- Σώμα χυτού αλουμινίου / Die-casting aluminum.
- Ρυθμιζόμενος βραχίονας / Adjustable bracket.
- Ντουί / Lampholder PAR30.



ΓΚΡΙ
GREY

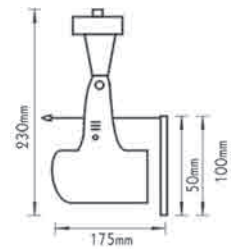

AC.045XFST6

Προβολέας οροφής - επίτοιχος / Ceiling - wall flood luminaire MR16



XFST29A

***XFST29A MR16**

- Σώμα αλουμινίου / Aluminum body.
- Ρυθμιζόμενος βραχίονας / Adjustable bracket.
- Ντουί / Lampholder MR16.

ΓΚΡΙ
GREY

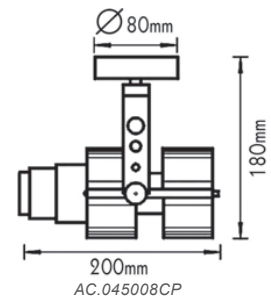

AC.045008CP

Συμπεριλαμβάνεται μετασχηματιστής / Ballast is included

Επίτοιχα σποτ / Wall spot luminaires G12 - R7s



AC.045XF828G

***AC.045XF828G G12 Metal Halide max. 70W**

***AC.045XF8028 R7s 78mm max. 150W**

- Σώμα αλουμινίου / Aluminum body.
- Πυρίμαχο διαφανές γυαλί / Fire-resistant clear glass.
- Ανταυγαστήρας ανοδιωμένου αλουμινίου / Anodized aluminum reflector.
- Ρυθμιζόμενος βραχίονας / Adjustable bracket.
- Ντουί / Lampholder G12 - R7s.

ΓΚΡΙ
GREY

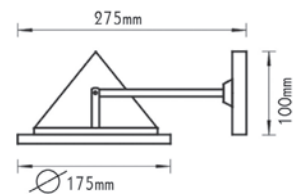

AC.045XF8028

Δεν συμπεριλαμβάνεται σύστημα έναυσης / No included gear box

***Υπό κατάργηση / Under abolition**

www.acalight.gr

Προβολέας / Flood luminaire HQI RX7s



AC.045H75W

ΛΕΥΚΟ
WHITE



ΜΑΥΡΟ
BLACK



ΓΚΡΙ
GREY



METAL HALIDE 70W HQI-TS

*AC.045H75M Λευκό / White

METAL HALIDE 150W HQI-TS

*AC.045H75B Μαύρο / Black

- Σώμα χυτού αλουμινίου / Die-casting aluminum body.
- Πυρίμαχο διαφανές γυαλί / Fire-resistant clear glass.
- Ρυθμιζόμενος βραχίονας / Adjustable bracket.
- Ντουί / Lampholder RX7s.

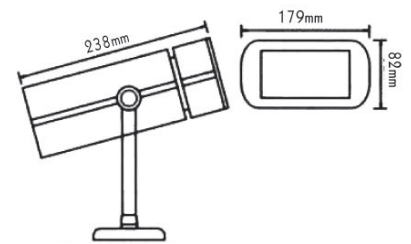

AC.045H75W

Προβολέας οροφής / Ceiling flood luminaire HQI



AC.045XF803B

*AC.045XF803B G12 max. 150w

*XFST27C G12 max. 70w

- Σώμα χυτού αλουμινίου / Die-casting aluminum body.
- Πυρίμαχο διαφανές γυαλί / Fire-resistant clear glass.
- Ντουί / Lampholder G12.

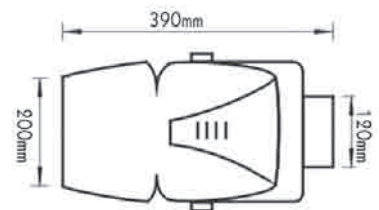

AC.045XF803B



XFST27C

ΓΚΡΙ
GREY

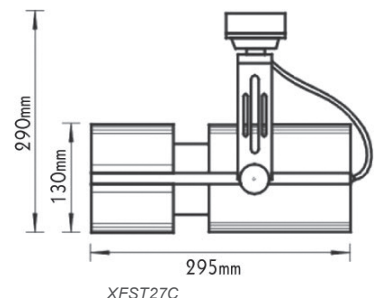

XFST27C

Προβολέας / Ceiling flood luminaire HQI RX7s



AC.045XFS13A



AC.045XFS13

230V | RX7s max. 70W

*AC.045XFST13

*AC.045XFS13A

- Σώμα χυτού αλουμινίου / Die-casting aluminum body.
- Πυρίμαχο διαφανές γυαλί / Fire-resistant clear glass.
- Αποσπώμενη επέκταση αλουμινίου / Removable aluminum extension.
- Ντουί / Lampholder RX7s HQI.



Τοποθετείστε / Install
LED SMD Module 30W
ή / or LED RX7s dimmable

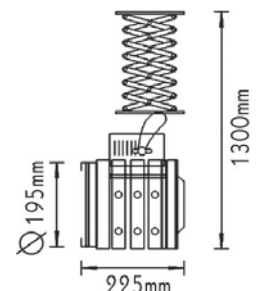

ΧΡΩΜΙΟ
CHROME



*Υπό κατάργηση / Under abolition

Σποτ ράγας 2 καλωδίων / 2 wires track luminaires GU10



TS67GU3CW

TS67GU3CW Λευκό / White No67

TS67GU3CB Μαύρο / Black No67

- Σώμα από μέταλλο / Metal body.
- Ρυθμιζόμενος βραχίονας / Adjustable bracket.
- Ντουί / Lampholder GU10.

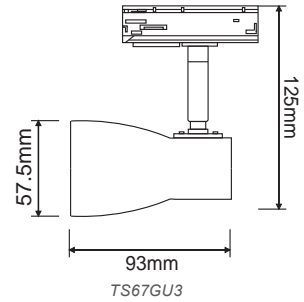

TS67GU3



TS68GU3CG

TS68GU3CW Λευκό / White No68

TS68GU3CB Μαύρο / Black No68

TS68GU3CG Γκρι / Grey No68

- Σώμα χυτού αλουμινίου / Die-casting aluminum body.
- Ρυθμιζόμενος βραχίονας / Adjustable bracket.
- Ντουί / Lampholder GU10.

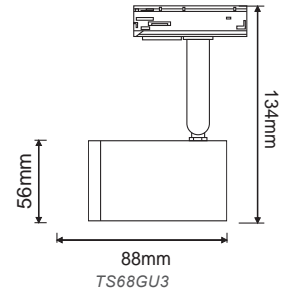

TS68GU3



TS75GU3CB

TS75GU3CW Λευκό / White No75

TS75GU3CB Μαύρο / Black No75

- Σώμα από μέταλλο / Metal body.
- Ρυθμιζόμενος βραχίονας / Adjustable bracket.
- Ντουί / Lampholder GU10.

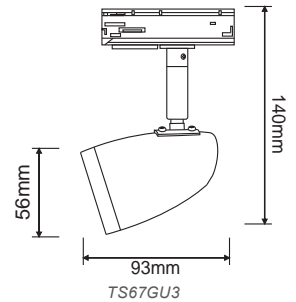

TS67GU3



TS40GU3CNM

TS40GU3CNM Νίκελ ματ / Nickel matt No40

- Σώμα χυτού αλουμινίου & γυαλιού / Die-casting aluminum & glass body.
- Ρυθμιζόμενος βραχίονας / Adjustable bracket.
- Ντουί / Lampholder GU10.

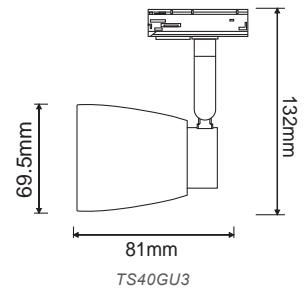

TS40GU3

Σποτ ράγας 2 καλωδίων / 2 wires track luminaires GU10 MASTO



BS49T2SG

BS49T2BN Μαύρο νέου τύπου / New type black

BS49T2WN Λευκό νέου τύπου / New type white

BS49T2GN Γκρι νέου τύπου / New type grey

BS49T2W Λευκό / White

BS49T2SG Γκρι / Grey

- Σώμα χυτού αλουμινίου / Die-casting aluminum body.
- Ρυθμιζόμενη γωνία φωτισμού / Adjustable beam angle.
- Ελατήρια για συγκράτηση οποιουδήποτε μήκους λαμπτήρα GU10 / Springs to hold any length of GU10 lamp.
- Ντουί / Lampholder GU10.

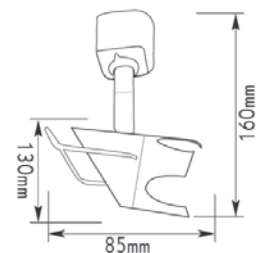

Ο λαμπτήρας δεν συμπεριλαμβάνεται / Lamp is not included

Σποτ ράγας 2 καλωδίων / 2 wires track luminaires GU10 AR111



TS68AR3CW



TS68AR3CB

TS68AR3CW Λευκό / White No68

TS68AR3CB Μαύρο / Black No68

TS68AR3CG Γκρι / Grey No68

- Σώμα χυτού αλουμινίου / Die-casting aluminum body.
- Ρυθμιζόμενος βραχίονας / Adjustable bracket.
- Ντουί / Lampholder GU10 AR111.

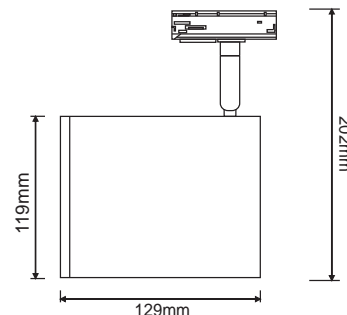

Τοποθετείστε / Install
LED AR111 GU10



Σποτ ράγας 2 καλωδίων / 2 wires track luminaires G53 AR111 ESTER



***AC.045XM2931**

- Σώμα χυτού αλουμινίου / Die-casting aluminum body
- Ρυθμιζόμενος βραχίονας / Adjustable bracket
- Ντουί / Lampholder G53 AR111 12V



Συμπεριλαμβάνεται μετασχηματιστής 12V
Included ballast 12V

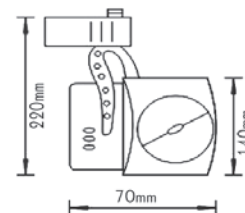

Σποτ ράγας 2 καλωδίων / 2 wires track spot luminaire E27 PAR30 SPYDIE



SPYDIE27W

SPYDIE27W Λευκό κενό / White empty

SPYDIE27B Μαύρο κενό / Black empty

SPYDIE27G Γκρι κενό / Grey empty

- Σώμα από χυτό αλουμίνιο / Die-casting aluminium body.
- Ντουί E27 PAR30 / Lampholder E27 PAR30.



Ο λαμπτήρας δεν συμπεριλαμβάνεται / Lamp is not included

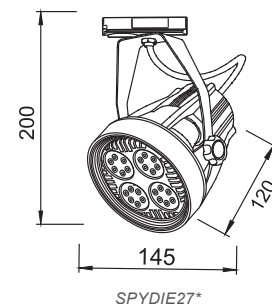

Περιστροφή / Rotation



Σημείωση: Συμβατά μόνο με ράγα 2 καλωδίων του τύπου 2W*M* (2W1MW, 2W2MW κλπ)
Notice: Compatible only with 2 wires track of type 2W*M* (2W1MW, 2W2MW etc)



Τοποθετείστε / Install

PAR30 LED 35W



Σποτ ράγας 2 καλωδίων / 2 wires track luminaires PAR30



TS68PAR3CB

TS68PAR3CW Λευκό / White No68

TS68PAR3CB Μαύρο / Black No68

TS68PAR3CG Γκρι / Grey No68

- Σώμα χυτού αλουμινίου / Die-casting aluminum body.
- Ρυθμιζόμενος βραχίονας / Adjustable bracket.
- Ντουί / Lampholder E27 PAR30.

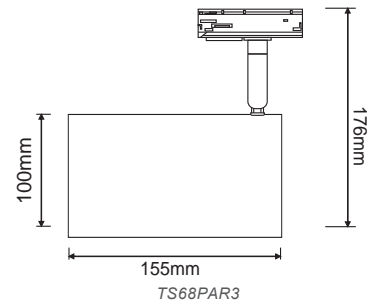

TS13PAR3CWG

TS13PAR3CWG Λευκό - Βουρτσιστό χρυσό / White - Brushed gold No13

TS13PAR3CB Μαύρο / Black No13

- Σώμα από μέταλλο / Metal body.
- Ρυθμιζόμενος βραχίονας / Adjustable bracket.
- Ντουί / Lampholder E27 PAR30.

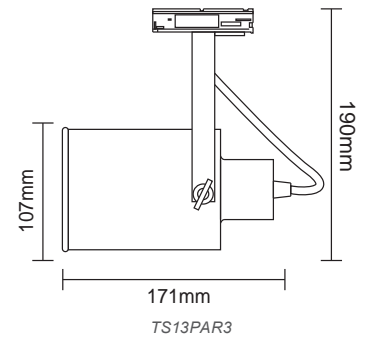

Σποτ ράγας 2 & 4 καλωδίων / 2 & 4 wires track luminaires PAR30 - PAR38 E27 CLUMP



AC.045XFST6T4

***AC.045XFST6T4** 4 καλωδίων / 4 wires PAR30

***AC.045XFST7T** 2 καλωδίων / 2 wires PAR38

***AC.045XFST7T4** 4 καλωδίων / 4 wires PAR38

- Σώμα χυτού αλουμινίου / Die-casting aluminum body.
- Ντουί / Lampholder E27 PAR30-PAR38.

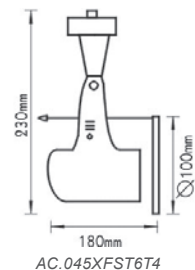

AC.045XFST7T4

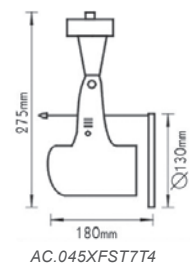

Σποτ ράγας 4 καλωδίων / 4 wires track luminaires GU10



TS67GU4CW

TS67GU4CW Λευκό / White No67

TS67GU4CB Μαύρο / Black No67

- Σώμα από μέταλλο / Metal body.
- Ρυθμιζόμενος βραχίονας / Adjustable bracket.
- Ντουί / Lampholder GU10.

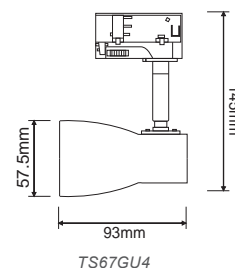

TS67GU4



TS68GU4CW

TS68GU4CW Λευκό / White No68

TS68GU4CB Μαύρο / Black No68

TS68GU4CG Γκρι / Grey No68

- Σώμα χυτού αλουμινίου / Die-casting aluminum body.
- Ρυθμιζόμενος βραχίονας / Adjustable bracket.
- Ντουί / Lampholder GU10.

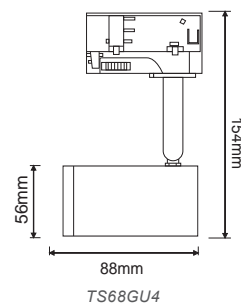

TS68GU4



TS75GU4CB

TS75GU4CW Λευκό / White No75

TS75GU4CB Μαύρο / Black No75

- Σώμα από μέταλλο / Metal body.
- Ρυθμιζόμενος βραχίονας / Adjustable bracket.
- Ντουί / Lampholder GU10.

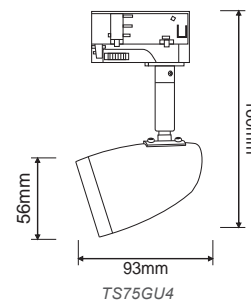

TS75GU4



TS40GU4CNM

TS40GU4CNM Νίκελ ματ / Nickel matt No40

- Σώμα χυτού αλουμινίου & γυαλιού / Die-casting aluminum & glass body.
- Ρυθμιζόμενος βραχίονας / Adjustable bracket
- Ντουί / Lampholder GU10.

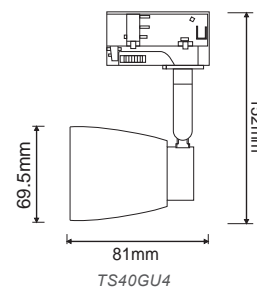

TS40GU4

Σποτ ράγας 4 καλωδίων / 4 wires track luminaires GU10 PARSCO



F8GU104KW

F8GU104KW Λευκό μικρό / Small white

F8GU104KB Μαύρο μικρό / Small black

F8GU104KG Γκρι μικρό / Small grey

F10GU104KW Λευκό μεγάλο / Big white

F10GU104KB Μαύρο μεγάλο / Big black

F10GU104KG Γκρι μεγάλο / Big grey

- Σώμα χυτού αλουμινίου / Die-casting aluminum body.
- Ρυθμιζόμενος βραχίονας / Adjustable bracket.
- Ντουί / Lampholder GU10.

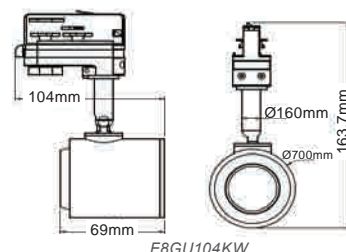

F8GU104KW

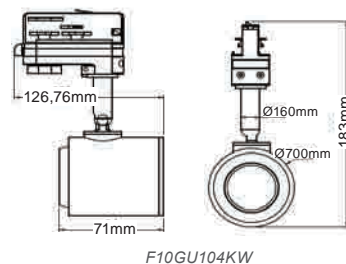

F10GU104KW



Σποτ ράγας 4 καλωδίων / 4 wires track luminaires GU10 AR111

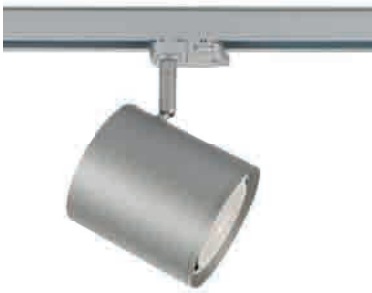

TS68AR4CW

TS68AR4CW Λευκό / White No68

TS68AR4CB Μαύρο / Black No68

TS68AR4CG Γκρι / Grey No68

- Σώμα χυτού αλουμινίου / Die-casting aluminum body.
- Ρυθμιζόμενος βραχίονας / Adjustable bracket.
- Ντουί / Lampholder GU10 AR111.

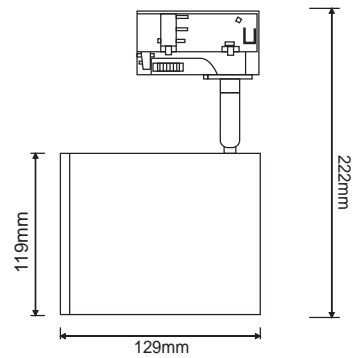

Τοποθετείστε / Install
LED AR111 GU10



Σποτ ράγας 4 καλωδίων / 4 wires track luminaires G53 AR111 OPTIC



Q41114KW

***Q41114KW** Λευκό / White

***Q41114KB** Μαύρο / Black

***Q41114KG** Γκρι / Grey

- Σώμα χυτού αλουμινίου / Die-casting aluminum body.
- Ρυθμιζόμενος βραχίονας / Adjustable bracket.
- Ντουί / Lampholder G53 AR111.

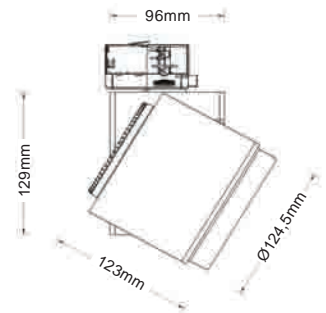

Τοποθετείστε / Install
LED SMD Module 30W
ή / or LED ARGU10



Τα σποτ είναι κενά και δεν συμπεριλαμβάνουν μετασχηματιστή 12V
Spot luminaires are empty and do not include ballast 12V



Σποτ ράγας 4 καλωδίων / 4 wires track luminaires G53 AR111 GUNO



GD18QTN4MTB

***GD18QTN4MTW** Λευκό / White

***GD18QTN4MTB** Μαύρο / Black

***GD18QTN4MT** Γκρι / Grey

- Σώμα χυτού αλουμινίου / Die-casting aluminum body.
- Ρυθμιζόμενος βραχίονας / Adjustable bracket.
- Ντουί / Lampholder G53 AR111.

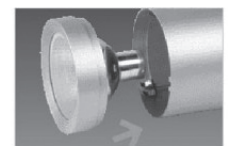
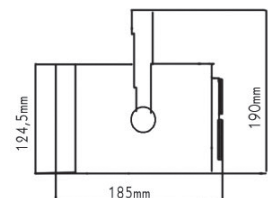

Τα σποτ είναι κενά και δεν συμπεριλαμβάνουν μετασχηματιστή 12V
Spot luminaires are empty and do not include ballast 12V

Σποτ ράγας 4 καλωδίων / 4 wires track luminaires PAR30



TS68PAR4CW

TS68PAR4CW Λευκό / White No68

TS68PAR4CB Μαύρο / Black No68

TS68PAR4CG Γκρι / Grey No68

- Σώμα χυτού αλουμινίου / Die-casting aluminum body
- Ρυθμιζόμενος βραχίονας / Adjustable bracket
- Ντουί / Lampholder E27 PAR30.

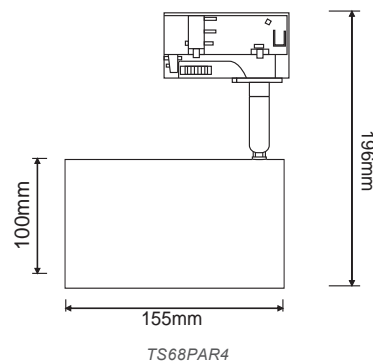

TS68PAR4CG



TS13PAR4CB

TS13PAR4CWG Λευκό - Βουρτσιαστό χρυσό / White - Brushed gold No13

TS13PAR4CB Μαύρο / Black No13

- Σώμα από μέταλλο / Metal body.
- Ρυθμιζόμενος βραχίονας / Adjustable bracket.
- Ντουί / Lampholder E27 PAR30.

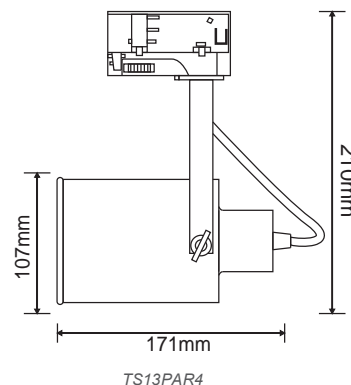

Τοποθετείστε / Install
LED PAR30



Σποτ ράγας 4 καλωδίων / 4 wires track luminaires GU5.3 MR16 QANO



***XFST29AT** Γκρι / Grey

- Σώμα χυτού αλουμινίου / Die-casting aluminum body
- Ρυθμιζόμενος βραχίονας / Adjustable bracket
- Ντουί / Lampholder GU5.3 MR16.

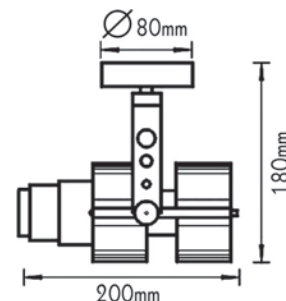

Συμπεριλαμβάνεται μετασχηματιστής 12V
Included ballast 12V

Σποτ ράγας 4 καλωδίων / 4 wires track luminaires GU5.3 MR16 - GU10 RODOL



GD35CBTN4MT

*GD35CBTN4MTW Λευκό / White MR16

*GD35CBTN4MT Γκρι / Grey MR16

*GD35GU10TN4MTW Λευκό / White GU10

- Σώμα χυτού αλουμινίου / Die-casting aluminum body.
- Ρυθμιζόμενος βραχίονας / Adjustable bracket.
- Ντουί / Lampholder GU5.3 MR16 - GU10.

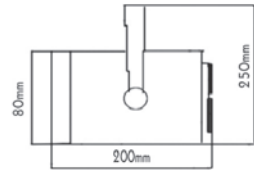

Τα φωτιστικά GU5.3 MR16 δεν συμπεριλαμβάνουν μετασχηματιστή 12V
Luminaires GU5.3 MR16 do not include ballast 12V

Σποτ ράγας 4 καλωδίων / 4 wires track luminaires PAR30 E27 TOOB



GD18PTN4MT

*GD18PTN4MTW Λευκό / White

*GD18PTN4MTB Μαύρο / Black

*GD18PTN4MT Γκρι / Grey

- Σώμα χυτού αλουμινίου / Die-casting aluminum body.
- Ρυθμιζόμενος βραχίονας / Adjustable bracket.
- Ντουί / Lampholder E27 PAR30.

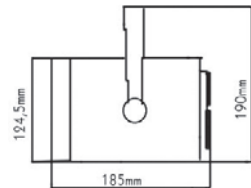

Σποτ ράγας 4 καλωδίων / 4 wires track luminaires CDMR HQI - PAR30 E27 TOGI



GD19RTN4MTB

*GD19RTN4MTB Μαύρο / Black

*GD19RTN4MT Γκρι / Grey

- Σώμα χυτού αλουμινίου / Die-casting aluminum body.
- Ρυθμιζόμενος βραχίονας / Adjustable bracket.
- Ντουί / Lampholder CDMR HQI E27 PAR30.

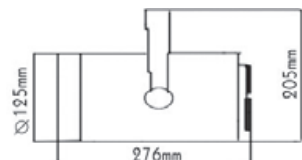

Τα φωτιστικά δεν συμπεριλαμβάνουν σύστημα έναυσης
Luminaires do not include gear box

*Υπό κατάργηση / Under abolition

www.acalight.gr

Σποτ ράγας 4 καλωδίων / 4 wires track luminaires G12 CDMT - E27



GD20TTN4MTB

*GD20TTN4MTW Λευκό / White

*GD20TTN4MTB Μαύρο / Black

*GD20TTN4MT Γκρι / Grey

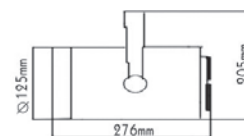

GD20TTN4MTB



GD15TTN4MT

*GD15TTN4MT Γκρι / Grey

*GD16TTN4MT Γκρι / Grey

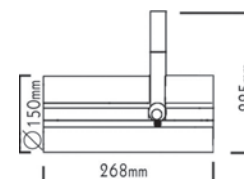

GD15TTN4MT



GD16TTN4MT

- Σώμα χυτού αλουμινίου / Die-casting aluminum body.
- Ρυθμιζόμενος βραχίονας / Adjustable bracket.
- Ντουί / Lampholder G12 CDMT max. 150W - E27.

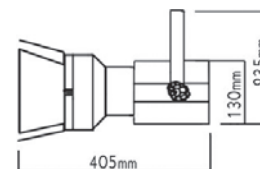

GD16TTN4MT

Τα φωτιστικά δεν συμπεριλαμβάνουν σύστημα έναυσης
Luminaires do not include gear box

Σποτ ράγας 4 καλωδίων / 4 wires track luminaires RX7s HQI CARPY



*XM2475SG

- Σώμα χυτού αλουμινίου / Die-casting aluminum body.
- Ρυθμιζόμενος βραχίονας / Adjustable bracket.
- Ντουί / Lampholder RX7s.

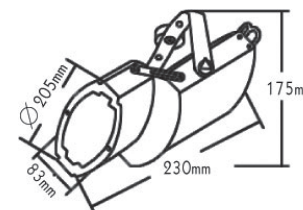

Τα φωτιστικά δεν συμπεριλαμβάνουν σύστημα έναυσης
Luminaires do not include gear box

Επίτοιχη βάση για προβολείς & σποτ ράγας / Wall mounted base for flood & track luminaires



GDBAW Λευκό / White

GDBA Γκρι / Grey

GDBAB Μαύρο / Black

- Σώμα αλουμινίου / Aluminum body.

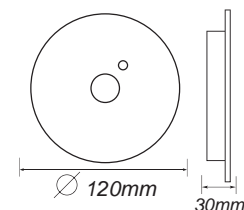

Η βάση προσαρμόζεται στους περισσότερους προβολείς ράγας για μετατροπή σε επίτοιχος.
Base is adaptable in most track floodlights in order to become wall mounted.

Ράγες & εξαρτήματα ράγας 2 καλωδίων (μονοφασική) / 2 wires (1 phase) tracks & accessories



2W1MB
2W2MB
2W3MB



2WIB



2WLW



2WVW



2WTRB



2WTB



2WADW



2WTEW



2WXW

ΛΕΥΚΟ MAT
MATT WHITE



ΜΑΥΡΟ MAT
MATT BLACK



ΓΚΡΙ MAT
MATT GREY



2W1MW Ράγα 2 καλωδίων 1m λευκή / Track 2 wires 1m white

2W1MG Ράγα 2 καλωδίων 1m γκρι / Track 2 wires 1m grey

2W1MB Ράγα 2 καλωδίων 1m μαύρη / Track 2 wires 1m black

2W2MW Ράγα 2 καλωδίων 2m λευκή / Track 2 wires 2m white

2W2MG Ράγα 2 καλωδίων 2m γκρι / Track 2 wires 2m grey

2W2MB Ράγα 2 καλωδίων 2m μαύρη / Track 2 wires 2m black

2W3MW Ράγα 2 καλωδίων 3m λευκή / Track 2 wires 3m white

2W3MG Ράγα 2 καλωδίων 3m γκρι / Track 2 wires 3m grey

2W3MB Ράγα 2 καλωδίων 3m μαύρη / Track 2 wires 3m black

2WIW Ένωση ευθείας 2 καλωδίων λευκή / White straight connector for 2 wires

2WIG Ένωση ευθείας 2 καλωδίων γκρι / Grey straight connector for 2 wires

2WIB Ένωση ευθείας 2 καλωδίων μαύρη / Black straight connector for 2 wires

2WLW Γωνία 90° 2 καλωδίων λευκή / White 90° corner for 2 wires

2WLG Γωνία 90° 2 καλωδίων γκρι / Grey 90° corner for 2 wires

2WLB Γωνία 90° 2 καλωδίων μαύρη / Black 90° corner for 2 wires

2WTW ΤΑΦ ράγας 2 καλωδίων λευκό / White "T" connector for 2 wires

2WTG ΤΑΦ ράγας 2 καλωδίων γκρι / Grey "T" connector for 2 wires

2WTB ΤΑΦ ράγας 2 καλωδίων μαύρο / Black "T" connector for 2 wires

2WXW Σταυρός ράγας 2 καλωδίων λευκός / White cross connector for 2 wires

2WVW Μεταβλητή γωνία 2 καλωδίων λευκή / White variable angle for 2 wires

2WVG Μεταβλητή γωνία 2 καλωδίων γκρι / Grey variable angle for 2 wires

2WVB Μεταβλητή γωνία 2 καλωδίων μαύρη / Black variable angle for 2 wires

2WADW Αντάπτορας 2 καλωδίων λευκός / White adaptor for 2 wires track

2WADG Αντάπτορας 2 καλωδίων γκρι / Grey adaptor for 2 wires track

2WADB Αντάπτορας 2 καλωδίων μαύρος / Black adaptor for 2 wires track

2WTRW Τροφ/κό 2 καλωδίων λευκό / White power supply for 2 wires track

2WTRG Τροφ/κό 2 καλωδίων γκρι / Grey power supply for 2 wires track

2WTRB Τροφ/κό 2 καλωδίων μαύρο / Black power supply for 2 wires track

2WTEW Τερματικό 2 καλωδίων λευκό / White end-cap for 2 wires track

2WTEG Τερματικό 2 καλωδίων γκρι / Grey end-cap for 2 wires track

2WTEB Τερματικό 2 καλωδίων μαύρο / Black end-cap for 2 wires track

Ράγες & εξαρτήματα ράγας 2 καλωδίων (μονοφασική) παλαιού τύπου / Old type 2 wires (1 phase) tracks & accessories



DZDIY2MT1MW



DZDIY2MTI



DZDIY2MTL



2MTADW



AC.045304

ΛΕΥΚΟ
WHITE



ΓΚΡΙ
GREY



***DZDIY2MT1MW** Ράγα 1m λευκή / Track 1m white

***DZDIY2MT15M** Ράγα 1,5m γκρι / Track 1,5m grey

***DZDIY2MT2MW** Ράγα 2m λευκή / Track 2m white

***DZDIY2MT3M** Ράγα 3m γκρι / Track 3m grey

***2MTADG** Αντάπτορας χωρίς καλώδιο γκρι / Adaptor without wire grey

***2MTADW** Αντάπτορας με 2m καλώδιο γκρι / Track adaptor with 2m wire grey

***DZDIY2MTIW** Ένωση ράγας λευκή / Track Joint white

***DZDIY2MTI** Ένωση ράγας γκρι / Track Joint grey

***DZDIY2MTL** Γωνία ράγας γκρι / "L" joint grey

***WTW** Ταφ ράγας λευκό / "T" white

***DZDIY2MTT** Ταφ ράγας γκρι / "T" grey

***WTSG** Ταφ ράγας γκρι / "T" grey

***DZDIY2MTX** Σταυρός ράγας γκρι / Cross track grey

WE2SG Τάπα ράγας γκρι

***Υπό κατάργηση / Under abolition**

Ράγες & εξαρτήματα ράγας 4 καλωδίων (τριφασική) / 4 wires (3phase) tracks & accessories



- 4W1MW Ράγα 4 καλωδίων 1m λευκή / Track 4 wires 1m white
- 4W1MG Ράγα 4 καλωδίων 1m γκρι / Track 4 wires 1m grey
- 4W1MB Ράγα 4 καλωδίων 1m μαύρη / Track 4 wires 1m black
- 4W2MW Ράγα 4 καλωδίων 2m λευκή / Track 4 wires 2m white
- 4W2MG Ράγα 4 καλωδίων 2m γκρι / Track 4 wires 2m grey
- 4W2MB Ράγα 4 καλωδίων 2m μαύρη / Track 4 wires 2m black
- 4W3MW Ράγα 4 καλωδίων 3m λευκή / Track 4 wires 3m white
- 4W3MG Ράγα 4 καλωδίων 3m γκρι / Track 4 wires 3m grey
- 4W3MB Ράγα 4 καλωδίων 3m μαύρη / Track 4 wires 3m black
- 4WIB Ένωση ευθείας 4 καλωδίων λευκή / White straight connector for 4 wires
- 4WIG Ένωση ευθείας 4 καλωδίων γκρι / Grey straight connector for 4 wires
- 4WIB Ένωση ευθείας 4 καλωδίων μαύρη / Black straight connector for 4 wires
- 4WLW Γωνία 90° 4 καλωδίων λευκή / White 90° corner for 4 wires
- 4WLG Γωνία 90° 4 καλωδίων γκρι / Grey 90° corner for 4 wires
- 4WLB Γωνία 90° 4 καλωδίων μαύρη / Black 90° corner for 4 wires
- 4WTW ΤΑΦ ράγας 4 καλωδίων λευκό / White "T" connector for 4 wires
- 4WTG ΤΑΦ ράγας 4 καλωδίων γκρι / Grey "T" connector for 4 wires
- 4WTB ΤΑΦ ράγας 4 καλωδίων μαύρο / Black "T" connector for 4 wires
- 4WXW Σταυρός ράγας 4 καλωδίων λευκός / White cross connector for 4 wires
- 4WXG Σταυρός ράγας 4 καλωδίων γκρι / Grey cross connector for 4 wires
- 4WXB Σταυρός ράγας 4 καλωδίων μαύρος / Black cross connector for 4 wires
- 4WVW Μεταβλητή γωνία 4 καλωδίων λευκή / White variable angle for 4 wires
- 4WVG Μεταβλητή γωνία 4 καλωδίων γκρι / Grey variable angle for 4 wires
- 4WVB Μεταβλητή γωνία 4 καλωδίων μαύρη / Black variable angle for 4 wires
- 4WADW Αντάπτορας 4 καλωδίων λευκός / White adaptor for 4 wires track
- 4WADG Αντάπτορας 4 καλωδίων γκρι / Grey adaptor for 4 wires track
- 4WADB Αντάπτορας 4 καλωδίων μαύρος / Black adaptor for 4 wires track
- 4WTRW Τροφ/κό 4 καλωδίων λευκό / White power supply for 4 wires track
- 4WTRG Τροφ/κό 4 καλωδίων γκρι / Grey power supply for 4 wires track
- 4WTRB Τροφ/κό 4 καλωδίων μαύρο / Black power supply for 4 wires track
- 4WTEW Τερματικό 4 καλωδίων λευκό / White end-cap for 4 wires track
- 4WTEG Τερματικό 4 καλωδίων γκρι / Grey end-cap for 4 wires track
- 4WTEB Τερματικό 4 καλωδίων μαύρο / Black end-cap for 4 wires track
- 4WKRW Κρέμαση ράγας 4 καλωδίων λευκή / White pendant kit for 4 wires (2m)
- 4WKRK Κρέμαση ράγας 4 καλωδίων γκρι / Grey pendant kit for 4 wires (2m)
- 4WKRK Κρέμαση ράγας 4 καλωδίων μαύρη / Black pendant kit for 4 wires (2m)
- 4WSTW Στήριξη τοίχου 4 καλωδίων λευκή / White wall mounting for 4 wires
- 4WSTG Στήριξη τοίχου 4 καλωδίων γκρι / Grey wall mounting for 4 wires
- 4WSTB Στήριξη τοίχου 4 καλωδίων μαύρη / Black wall mounting for 4 wires
- 4WADSW Αντάπτορας στήριξης 4 καλωδίων λευκό / 4 wire white mount adaptor
- 4WADSG Αντάπτορας στήριξης 4 καλωδίων γκρι / 4 wire grey mount adaptor
- 4WADSB Αντάπτορας στήριξης 4 καλωδίων μαύρο / 4 wire black mount adaptor

Χωνευτές ράγες 4 καλωδίων / Recessed 4 wires tracks



- 4WRE1MW Χωνευτή ράγα 4 καλωδίων 1m λευκή / Recessed 4 wire track 1m white
- 4WRE2MW Χωνευτή ράγα 4 καλωδίων 2m λευκή / Recessed 4 wire track 2m white
- 4WRE3MW Χωνευτή ράγα 4 καλωδίων 3m λευκή / Recessed 4 wire track 3m white
- 4WREST Κλιπ χωνευτής εγκατάστασης ράγας 4 καλωδίων / Recessed installation clip for 4 wires track

Ράγες & εξαρτήματα ράγας 4 καλωδίων (τριφασική) παλαιού τύπου / Old type 4 wires (3phase) tracks & accessories

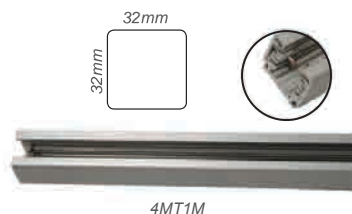

4MT1M



4MTLEW

4MTCB



4MTDEW

4MTAD



4MTIW

4MTLLEW



NK010GY

4MTADK



NK009CW

NK009CB

- *4MT1MW Ράγα 4 καλωδίων 1m λευκή / Track 4 wires 1m white
- *4MT1MB Ράγα 4 καλωδίων 1m μαύρη / Track 4 wires 1m black
- *4MT1M Ράγα 4 καλωδίων 1m γκρι / Track 4 wires 1m grey
- *4MT2M Ράγα 4 καλωδίων 2m γκρι / Track 4 wires 2m grey
- *4MT3M Ράγα 4 καλωδίων 3m γκρι / Track 4 wires 3m grey
- *4MT3MB Ράγα 4 καλωδίων 3m μαύρη / Track 4 wires 3m black
- *4MTLEW Τροφ/κό 4 καλωδίων λευκό / Power supply Track 4 wires white
- *4MTLEB Τροφ/κό 4 καλωδίων μαύρο / Power supply Track 4 wires black
- *4MTLE Τροφ/κό 4 καλωδίων γκρι / Power supply Track 4 wires grey
- *4MTDEW Τερματικό 4 καλωδίων λευκό / Terminal Track 4 wires white
- *4MTDEB Τερματικό 4 καλωδίων μαύρο / Terminal Track 4 wires black
- *4MTDE Τερματικό 4 καλωδίων γκρι / Terminal Track 4 wires grey
- *4MTADW Αντάπτορας 4 καλωδίων λευκός / Adaptor Track 4 wires white
- *4MTADB Αντάπτορας 4 καλωδίων μαύρος / Adaptor Track 4 wires black
- *4MTAD Αντάπτορας 4 καλωδίων γκρι / Adaptor Track 4 wires grey
- *4MTADK Αντάπτορας ράγας 4 καλωδίων γκρι με 2μ καλώδιο / Adaptor Track 4 wires grey with 2m wire
- *4MTADKB Αντάπτορας ράγας 4 καλωδίων μαύρος με 2μ καλώδιο / Adaptor Track 4 wires black with 2m wire
- *4MTADKW Αντάπτορας ράγας 4 καλωδίων λευκός με 2μ καλώδιο / Adaptor Track 4 wires white with 2m wire
- *4MTADKWT Αντάπτορας ράγας 4 καλωδίων λευκός με 2μ διαφανές καλώδιο / Adaptor Track 4 wires black with 2m transparent wire
- *4MTIW Ένωση 4 καλωδίων λευκή / "I" Joint for 4 wires white
- *4MTIB Ένωση 4 καλωδίων μαύρη / "I" Joint for 4 wires black
- *4MTI Ένωση 4 καλωδίων γκρι / "I" Joint for 4 wires grey
- *4MTLLEW Γωνία 4 καλωδίων λευκή / "L" Joint for 4 wires white
- *4MTLLE Γωνία 4 καλωδίων γκρι / "L" Joint for 4 wires grey
- *NK009CB Κρέμαση ράγας 4 καλωδίων μαύρη
- *NK010GY Σφιγκτήρας Κρέμασης ράγας 4 καλωδίων γκρι
- *4MTCB Σύνδεσμος στήριξης μαύρος / Connector for track support black
- *4MTC Σύνδεσμος στήριξης γκρι / Connector for track support grey
- *4MTT Ταφ ράγας 4 καλωδίων / "T" for 4 wires



Ράγες & εξαρτήματα ράγας 4 καλωδίων (μονοφασική) παλαιού τύπου / Old type 4 wires (1 phase) tracks & accessories OVAL



2M4SG



AD4SG

WI4SG



WL4SG

WT4SG

- *2M4SG Πλήρης ράγα 4 καλωδίων 2m γκρι / Complete track 4 wires 2m grey
- *AD4SG Αντάπτορας 4 καλωδίων γκρι / Adaptor track 4 wires grey
- *WI4SG Ένωση 4 καλωδίων γκρι / "I" Joint for 4 wires grey
- *WT4SG Ταφ ράγας 4 καλωδίων / "T" for 4 wires
- *WH4SG Τροφοδοτικό ράγας / Power supply track
- *WX4SG Σταυρός ράγας / Cross track

Καμπάνες στενής δέσμης / Narrow beam high bays G9



XM5201G9

XM5202G9

***XM5201G9**

***XM5202G9**

- Σώμα αλουμινίου / Aluminum body.
- Εσωτερική λευκή ηλεκτροστατική βαφή για μέγιστο αποτέλεσμα φωτισμού / Internal white powder coating for maximum lighting effect.
- Ντουί / Lampholder G9.

INOX

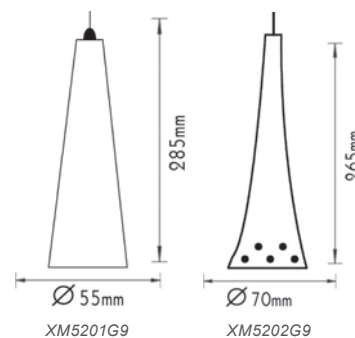

Καμπάνες / High bays GU10



XM5213GU10

***XM5213GU10**

- Σώμα αλουμινίου / Aluminum body.
- Εσωτερική λευκή ηλεκτροστατική βαφή για μέγιστο αποτέλεσμα φωτισμού / Internal white powder coating for maximum lighting effect.
- Ντουί / Lampholder GU10.

INOX



Καμπάνες / High bays E27 - G9



XM5222E27

XM5707SGG9

***XM5222E27 E27 inox**

***XM5707SGG9 G9 Γκρι / Grey**

- Σώμα αλουμινίου / Aluminum body.
- Δέσμη φωτισμού 90° / Lighting beam 90°.
- Ντουί / Lampholder E27.

INOX



ΓΚΡΙ
GREY

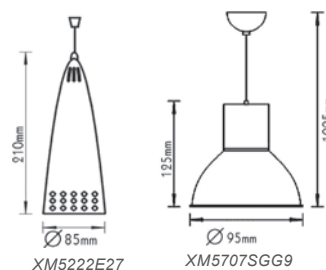

Απλικά τύπου καμπάνα Καμπάνες / High bay type wall luminaire E14



AC.045XFWL19

***AC.045XFWL19**

- Σώμα αλουμινίου / Aluminum body.
- Περιστρεφόμενος σπείρα βραχίονας / Rotating spiral bracket.
- Ντουί / Lampholder E14.

INOX

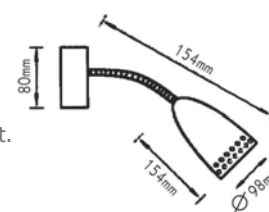

AC.045XFWL19

Καμπάνες / High bays E27



AC.3XF15B



AC.3XF15A



AC.3XF15



AC.3XF153



AC.3XF22



AC.3XF26



AC.3XF32



AC.3XF37



AC.3XF38



AC.3XF41



AC.3XF43



AC.045XF44W



AC.3XF48

- *AC.3XF15 Inox
- *AC.3XF15A Inox
- *AC.3XF15B Inox
- *AC.3XF153 Inox
- *AC.3XF22 Inox
- *AC.3XF26 Inox
- *AC.3XF32 Μπρονζέ / Bronze
- *AC.3XF37 Inox
- *AC.3XF38 Inox
- *AC.3XF41 Inox
- *AC.3XF43 Inox
- *AC.045XF44W Λευκό / White
- *AC.3XF48 Μπρονζέ / Bronze

- Σώμα αλουμινίου / Aluminum body.
- Εσωτερική λευκή ηλεκτροστατική βαφή για μέγιστο αποτέλεσμα φωτισμού / Internal white powder coating for maximum lighting effect.
- Ντου / Lampholder E27.

ΛΕΥΚΟ WHITE ΙΝΟΧ ΜΠΡΟΝΖΕ BRONZE



AC.3XF15B



AC.3XF15A

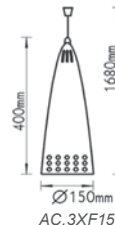

AC.3XF15

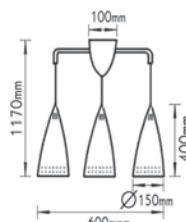

AC.3XF153

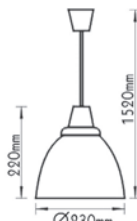

AC.3XF22

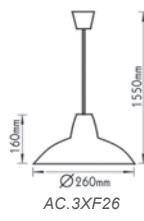

AC.3XF26

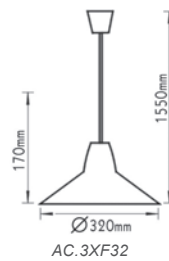

AC.3XF32

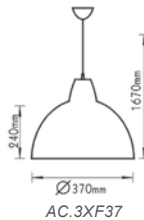

AC.3XF37

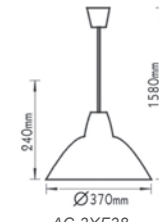

AC.3XF38

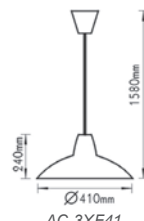

AC.3XF41

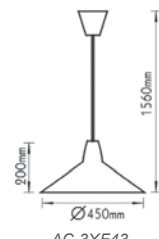

AC.3XF43

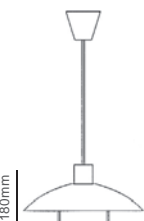

AC.045XF44W

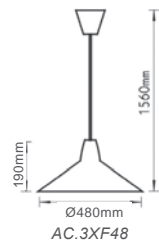

AC.3XF48

Καμπάνες με γυαλί / High bays with glass E27



AC.045XF47



AC.045XF330G

***AC.045XF47**

***AC.045XF330G**

- Σώμα αλουμινίου / Aluminum body.
- Ματ γυαλί / Matt glass.
- Ντουί / Lampholder E27.

INOX

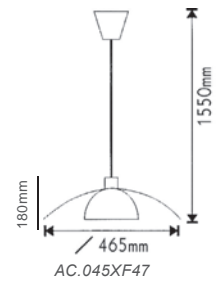

AC.045XF47

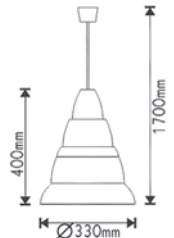

AC.045XF330G

Φωτιστικά τύπου πυροφάνι / Lantern type luminaires E27



***AC.045XF31**

***AC.045XF40A**

INOX

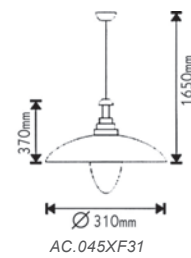

AC.045XF31

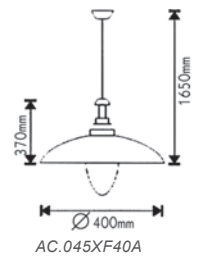

AC.045XF40A



AC.045F25A



AC.045F25K



AC.045F35K

AC.045F25K Κρεμαστό / Pendant Ø25

AC.045F30K Κρεμαστό / Pendant Ø30

AC.045F35K Κρεμαστό / Pendant Ø35

AC.045F25A Απλικά / Wall luminaire Ø25

AC.045F30A Απλικά / Wall luminaire Ø30

AC.045F35A Απλικά / Wall luminaire Ø35

- Σώμα αλουμινίου / Aluminum body.
- Διαφανές γυαλί / Clear glass.
- Ντουί / Lampholder E27.

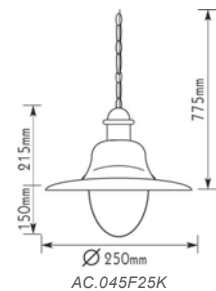

AC.045F25K

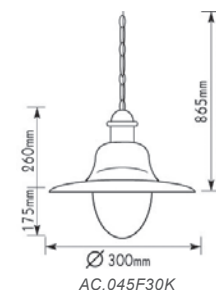

AC.045F30K

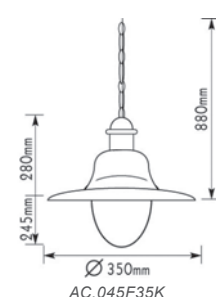

AC.045F35K



***Υπό κατάργηση / Under abolition**

Κρεμαστές καμπάνες / Pendant high bays E27

Καμπάνες / High bays

R020DL Κόκκινη / Red Ø25 max 26W IP65

B020DL Μπλε / Blue Ø25 max 26W IP65

G020DL Πράσινη / Green Ø25 max 26W IP65

R026DL Κόκκινη / Red Ø31 max 36W IP65

B026DL Μπλε / Blue Ø31 max 36W IP65

G026DL Πράσινη / Green Ø31 max 36W IP65

R027DL Κόκκινη / Red Ø31 max 36W IP45

B027DL Μπλε / Blue Ø31 max 36W IP45

G027DL Πράσινη / Green Ø31 max 36W IP45

Εξαρτήματα / Accessories

RSP45 Κόκκινη προέκταση σωλήνα + ροζέτα / Red tube extension + rosette

BSP45 Μπλε προέκταση σωλήνα + ροζέτα / Blue tube extension + rosette

GSP45 Πράσινη προέκταση σωλήνα + ροζέτα / Green tube extension + rosette

BPG9 Στυπιοθλίπτρας καμπάνας / High bay connector PG-9

- Σώμα χυτού αλουμινίου / Die-casting aluminum body.
- Ανταυγαστήρας ανοδιωμένου αλουμινίου / Anodized aluminum reflector.
- Διαφανές πυρίμαχο επίπεδο γυαλί (IP65) / Fire-resistant clear flat glass (IP65).
- Κρυσταλιζέ ηρισματικό πολυκαρμπονάτ κάλυμμα (IP45) / Granulated prismatic PC cover (IP45).
- Ανοξείδωτα μεταλλικά κλιπς / Stainless steel clips.
- Δυνατότητα τοποθέτησης σταθερής προέκτασης για υπαίθριους χώρους / Ability of mounting stable extension for outdoor applications.
- Φλάντζα στεγανοποίησης / Waterproof flange.
- Ντουί / Lampholder E27.

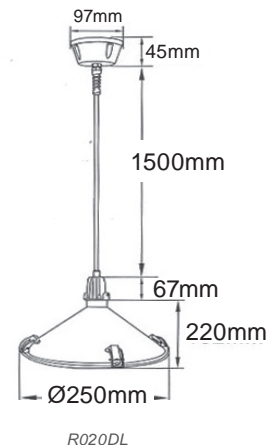

R020DL

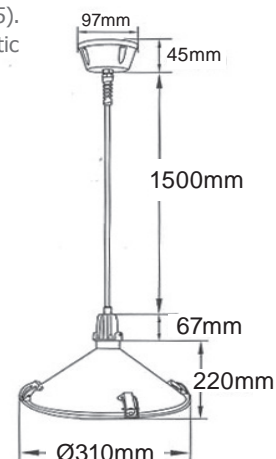

G026DL

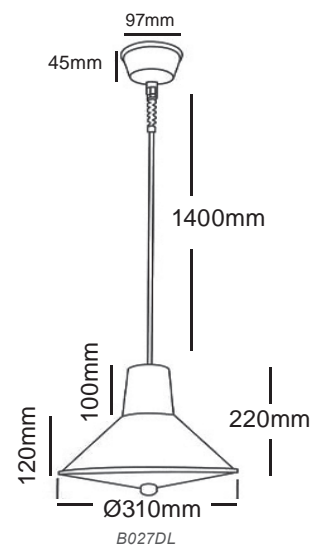

B027DL



R020DL



RSP45



G026DL



B027DL



ΚΟΚΚΙΝΟ
RED



ΜΠΛΕ
BLUE



ΠΡΑΣΙΝΟ
GREEN



Ιδανικό για χώρους εστίασης
Ideal for for dining areas

Κρεμαστές καμπάνες / Pendant high bays E27



SS008

SS008**AC.045XF12G**

- Σώμα από αστάλι / Steel body.
- Ακρυλικό πρισματικό κάλυμμα / Acrylic prismatic cover.
- Επιχρωμιωμένες λεπτομέρειες / Chromed details.
- Ντουί / Lampholder E27.

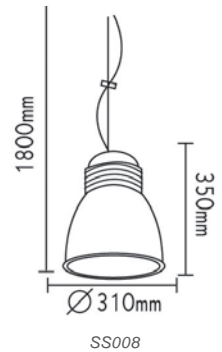

SS008



AC.045XF12G

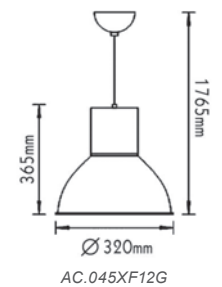
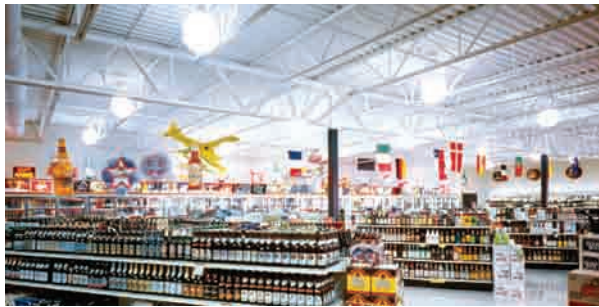

AC.045XF12G

NIKEL
NICKEL



Κρεμαστές καμπάνες / Pendant high bays R7s - RX7s - LED Module



SS015

SS015

- Σώμα αλουμινίου / Aluminum body.
- Πυρίμαχο διαφανές γυαλί / Fire-resistant clear glass.
- Επιχρωμιωμένες λεπτομέρειες / Chromed details.
- Ντουί / Lampholder L: 118mm R7s max100W - LED Module.

ΓΚΡΙ
GREY



SS015

Δεν συμπεριλαμβάνεται σύστημα έναυσης / Gear box is not included

Κρεμαστές καμπάνες / Pendant high bays G12 - E27 - LED Module



AC.045XF12E

AC.045XF12E E27 Κενό / Empty

- Σώμα χυτού αλουμινίου / Die-casting aluminum body.
- Ακρυλικό πρισματικό κάλυμμα / Acrylic prismatic cover.
- Ντουί / Lampholder E27 - LED Module.

ΓΚΡΙ
GREY

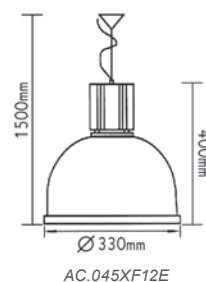

AC.045XF12E

Κρεμαστές καμπάνες στενής δέσμης / Pendant narrow beam high bays G12 - E27 - LED Module



SS020



SS022

***SS020 E27 Κενό / Empty**

***SS022 CDMT-E27 Κενό / Empty**

- Σώμα χυτού αλουμινίου / Die-casting aluminum body.
- Πυρίμαχο διαφανές γυαλί (SS022) / Fire-resistant clear glass (SS022).
- Ντουί / Lampholder E27 - LED Module.

ΓΚΡΙ
GREY

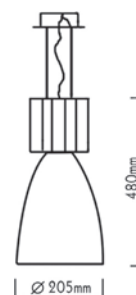

SS020

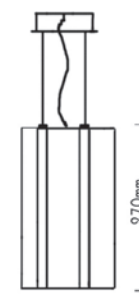

SS022

Κρεμαστές καμπάνες / Pendant high bays G12 - LED Module



SS036T400

***SS036T400 E27**

- Σώμα χυτού αλουμινίου / Die-casting aluminum body.
- Ανταυγαστήρας ανοδιωμένου αλουμινίου / Anodized aluminum reflector.
- Ντουί / Lampholder E27 - LED Module.

ΓΚΡΙ
GREY

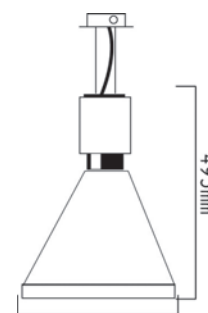

SS036T400

Σποτ πινάκων / Wall luminaires G4 - T5

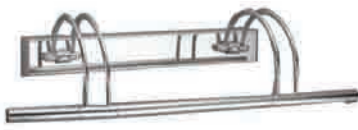

AC.045XFWL41

***AC.045XFWL41** Νικελ ματ / Nickel matt 4xG4

***AC.045XFWL41GA** Μπρονζέ / Bronze 4xG4

***XFWL58S** Γκρι / Grey T5 8W

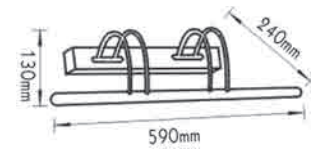

AC.045XFWL41



XFWL58S

- Σώμα από ατσάλι & χυτό αλουμίνιο / Steel & die-casting aluminum body.
- Ρυθμιζόμενος βραχίονας / Adjustable bracket.
- Ντουί / Lampholder G4 - G5 T5.

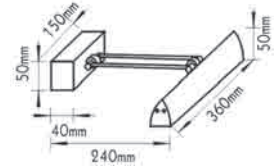

XFWL58S

Σποτ πινάκων / Wall luminaires G9



MB8223NM

MB8223NM Νικελ ματ / Nickel matt

MB8223GAB Μπρονζέ / Bronze

- Σώμα από ατσάλι & χυτό αλουμίνιο / Steel & die-casting aluminum body.
- Ρυθμιζόμενος βραχίονας / Adjustable bracket.
- Ντουί / Lampholder 2xG9.

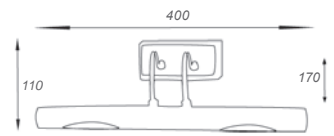

Σποτ πινάκων / Wall luminaires T5



MB0968GAB

1 x T5 max 8W

MB0968WGAB Μπρονζέ / Bronze

MB0808WGAB Μπρονζέ / Bronze

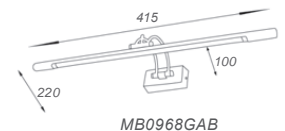

MB0968GAB



MB0808GAB

1 x T5 max 14W

MB09614WNM Νικελ ματ / Nickel matt

MB09614WGAB Μπρονζέ / Bronze

MB08014WNM Νικελ ματ / Nickel matt

MB08014WGAB Μπρονζέ / Bronz

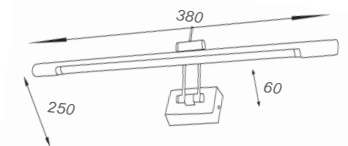

MB0808GAB



MB09614WGAB

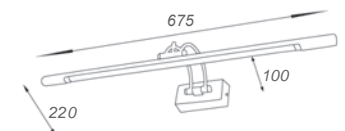

MB09614W*

- Σώμα από ατσάλι & χυτό αλουμίνιο / Steel & die-casting aluminum body.
- Ρυθμιζόμενος βραχίονας / Adjustable bracket.
- Ντουί / Lampholder G5 T5.



MB08014WNM

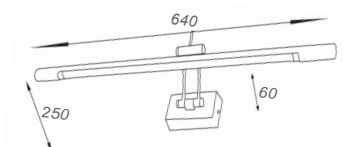

MB08014W*

Συμπεριλαμβάνεται λαμπτήρας T5 4.000K / T5 4.000K lamp is included

*Υπό κατάργηση / Under abolition

Multi string star fiber optic data



Διαφανής / Transparent

*PSTL075 Ø0,75mm L2700mm

*PSTL1 Ø1,00mm L1500mm

*PSTL15 Ø1,50mm L700mm



Σαγρή / Smooth

*PCL60 10mm

*PCL11 15mm



Διαφανής / Transparent

*PSL6 Ø6mm/8,8mm L60m

*PSL11 Ø11mm/14mm L60m



Μαύρη / Black

*PEL10 Ø1mm/2,3mm L1500m

*PEL25 Ø2,5mm/3,5mm L250m

*PEL3 Ø3mm/4,5mm L150m

*PEL6 Ø6mm/8,8mm L60m

*PEL14 Ø5,2mm/17,3mm L60m

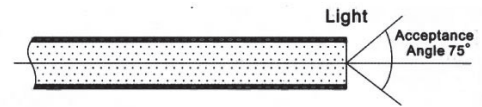
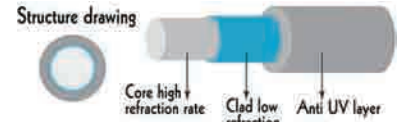
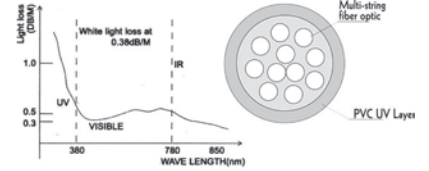

Solid fiber optic technical data	
1. core diameter (NO UV)	Ø 6mm: Ø 11mm: Ø 14mm
2. minimum bending radius recommended	4 times of the diameter
3. light loss	< 2% / feet
4. wave length	380 - 780NM
5. life-time	10 years
6. temperature	-20°C ~ 120°C
7. maximum length	60M
8. keeping temperature recommended	-15°C ~ +50°C

ΦΩΤΙΣΤΙΚΑ ΟΠΤΙΚΩΝ ΙΝΩΝ / Fiber optic luminaires

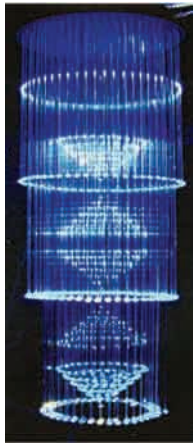

PCOFC4



PCOFC1

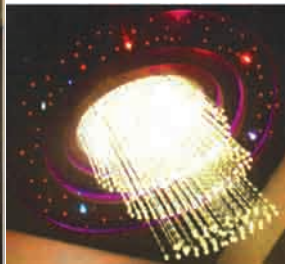

PCOFC3

*PCOFC4 Ø60x200cm

*PCOFC1 80x80x140cm

*PCOFC3 Ø120/60x150cm



Τερματικά οπτικών ινών / Fiber optic terminals

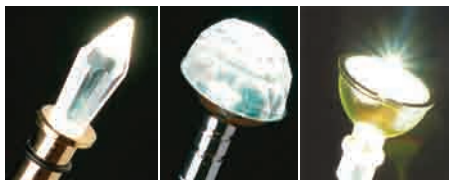

PFF005

PFF006

PFF012

*PFF005 BIG ICE

*PFF006 DIAMOND

*PFF012 DICHROIC

*PFF017 CRYSTAL

*PFF022 COW EYE

*PFF025 ROCKET GUN



PFF017

PFF025

PFF022

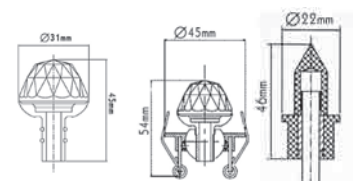
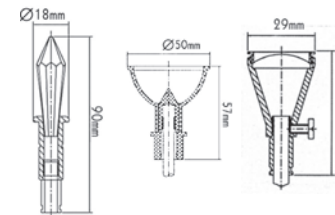

Εξαρτήματα οπτικών ινών / Fiber optic accessories series

**Πλαστικά διαφανή κανάλια στήριξης / Plastic transparent fixing channels**

*PA16 Για / For PSL-6,0/PSTL-314 L1,8m

*PA111 Για / For PSL-11/PSTL-614 L1,8m

Τα πλαστικά κανάλια χρησιμοποιούνται για τη στερέωση των οπτικών ινών και είναι πολύ εύκολο να εγκατασταθούν τόσο σε εσωτερικό όσο και σε εξωτερικό χώρο για τη στερέωση οπτικών ινών ευθείας γραμμής. / The plastic channels is used for fixing the fiberoptic, and it is very easy to install both indoors and outdoors for fixing straight-line fiberoptic.

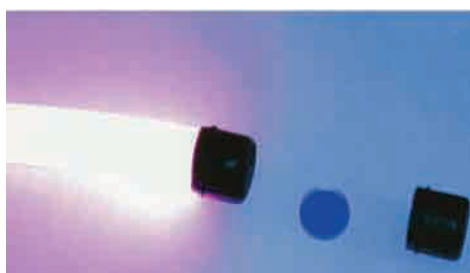
**Τερματική τάπα με ανακλαστήρα / End cap with reflector**

*PA26 Μαύρη / Black PSL-6,0 7,5mm

*PA211 Μαύρη / Black PSL-11 7,5mm

1. WITH LIGHT-REFLECT GLASS INSIDE.
2. SHOULD BE USED TOGETHER WITH SIDE-LIGHT FIBER OPTIC.

**Κλιπ τοποθέτησης / Mounting clips**

*PA36 Διαφανές για / Clear for PSL-6,0 9mm

*PA311 Διαφανές για / Clear for PSL-11 16mm

Τα κλιπ τοποθέτησης χρησιμοποιούνται για τη στερέωση της οπτικής ίνας. Πρέπει πρώτα να στερεωθούν με βίδες και στη συνέχεια τοποθετήστε την κατάλληλη οπτική ίνα στα κλιπ. Αυτό το είδος στερέωσης είναι πολύ σταθερό. / Mounting clip is used for fixing the fiberoptic. When mounting clip is used, it should be fixed by screws firstly, and then put the appropriate fiberoptic into the clips. Such kind of fixing is very firm.

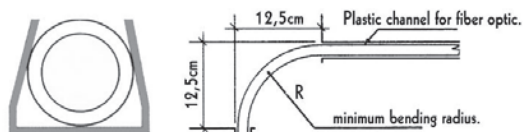

When the fiber optic should be fixed in certain forms (especially in straight lines), plastic or aluminium channel can be used. Such kind of accessories is most suitable for straight line fiber optic.

Attention: when the fiber optic should be bent installed, the bending radius should be larger than the minimum radius.

Ανεμιστήρες οροφής / Ceiling fans

IP44

 USA PATENT DESIGN



4TS52HAB
52"



4TS52HABOL
52"



4PH52CB
54"

4PH52CB 4 φτερών, τρίφωτο / 4 blades, three lights

4TS52HAB 8 φτερών χωρίς φως / 8 blades without lighting

4TS52HABOL 8 φτερών, μονόφωτο / 8 blades, one light

- Σώμα χυτού αλουμινίου / Die-casting aluminum body.
- Φτερά από πολυκαρβονικό ανθεκτικό πλαστικό / Durable polycarbonate plastic blades.
- Μοτέρ χαλκού υψηλής ποιότητας / High quality copper motor.
- Αλάβαστρο γυαλί (4PH52CB) / Alabaster glass (4PH52CB).
- Δυνατότητα ρύθμισης ύψους / Ability of height adjustment.
- Γωνία ρύθμισης φτερών 0-45° / Blade angle adjustment 0-45°.
- Ντουί / Lampholder E27.



0	098SO075	14
1	1042GPC	61
	1042WPC	61
2	28068	60
	28070	60
	28071	60
	28076	17
	2M4SG	112
	2MTADC	110
	2MTADW	110
	2W1MB	110
	2W1MG	110
	2W1MW	110
	2W2MB	110
	2W2MG	110
	2W2MW	110
	2W3MB	110
	2W3MG	110
	2W3MW	110
	2WADB	110
	2WADG	110
	2WADW	110
	2WIB	110
	2WIG	110
	2WIW	110
	2WLB	110
	2WLG	110
	2WLW	110
	2WTB	110
	2WTEB	110
	2WTEG	110
	2WTEW	110
	2WTG	110
	2WTRB	110
	2WTRG	110
	2WTRW	110
	2WTW	110
	2WVB	110
	2WVG	110
	2WVW	110
	2WXW	110
3	35316N	25
	35317N	25
	3533	25
	3534	25
4	47000	10
	4MT1M	112
	4MT1MB	112
	4MT1MW	112
	4MT2M	112
	4MT3M	112
	4MT3MB	112
	4MTAD	112
	4MTADB	112
	4MTADK	112
	4MTADKB	108
	4MTADKW	108
	4MTADKWT	108
	4MTADW	112
	4MTC	112
	4MTCB	112
	4MTDE	112
4MTDEB	112	
4MTDEW	112	
4MTI	112	

	4MTIB	112
	4MTIW	112
	4MTLE	112
	4MTLEB	112
	4MTLEW	112
	4MTLLE	112
	4MTLLEW	112
	4MTT	112
	4PH52CB	122
	4TS52HAB	122
	4TS52HABOL	122
	4W1MB	111
	4W1MG	111
	4W1MW	111
	4W2MB	111
	4W2MG	111
	4W2MW	111
	4W3MB	111
	4W3MG	111
	4W3MW	111
	4WADB	111
	4WADG	111
	4WADSB	111
	4WADSG	111
	4WADSW	111
	4WADW	111
	4WIB	111
	4WIG	111
	4WIW	111
	4WKRB	111
	4WKRG	111
	4WKRW	111
	4WLB	111
	4WLG	111
	4WLW	111
	4WRE1MW	111
	4WRE2MW	111
	4WRE3MW	111
	4WREST	111
	4WSTB	111
	4WSTG	111
	4WSTW	111
	4WTB	111
	4WTEB	111
	4WTEG	111
	4WTEW	111
	4WTG	111
	4WTRB	111
	4WTRG	111
	4WTRW	111
	4WTW	111
	4WVB	111
	4WVG	111
	4WVW	111
	4WXB	111
	4WXG	111
	4WXW	111
8	8001	9
	8003	10
	8004	9
	8021	5
	8033	5
	8035I	5
	8035II	5
	8080	9

	8087	9
	8202	9
	8318	9
	8328II	10
	8338II	9
	8338V	6
	8338I	6
	8416	9
	8430	10
	8502	7
A	AC.045005SG	17
	AC.045005WL	17
	AC.0450063	17
	AC.045006SG	17
	AC.045006WL	17
	AC.045007W	17
	AC.045008B	99
	AC.045008CB	99
	AC.045008CP	99
	AC.045008CW	99
	AC.045008CWL	99
	AC.045017W	17
	AC.045017WL	17
	AC.0451042EG	61
	AC.0451042G	61
	AC.0451042GA	61
	AC.0451042GM	61
	AC.0451042N	61
	AC.0451042NA	61
	AC.0451042NM	61
	AC.0451042NMA	61
	AC.0451042PG	61
	AC.0451042PN	61
	AC.0451042PS	61
	AC.0451042RA	61
	AC.0451042SG	61
	AC.0451042W	61
	AC.0451042WB	61
	AC.045250CB	20
	AC.045250CG	20
	AC.045250CW	20
	AC.0452711	74
	AC.0452731	74
	AC.0452781	74
	AC.04531GPBG	62
	AC.04531GPG	62
	AC.04531GPGG	62
	AC.04531SPGS	62
	AC.0453254B	66
	AC.0453254CP	66
	AC.0453254CPA	66
	AC.0453254G	66
	AC.0453254GA	66
	AC.0453254GM	66
	AC.0453254NM	66
	AC.0453254NMA	66
	AC.0453254PG	66
	AC.0453254PS	66
	AC.0453254RA	66
	AC.0453254SG	66
	AC.0453254W	66
	AC.0453254WB	66
	AC.04532G	68
	AC.04532GAB	68
	AC.04532GPG	68

	AC.04532N	68
	AC.04532NM	68
	AC.04532PG	68
	AC.04532PN	68
	AC.04532RAB	68
	AC.04532S	68
	AC.04532SPS	68
	AC.04532W	68
	AC.04533G	67
	AC.04533GAB	67
	AC.04533GM	67
	AC.04533NM	67
	AC.04533RAB	67
	AC.04533W	67
	AC.04533WB	67
	AC.045400CG	20
	AC.045400CO	20
	AC.045400CW	20
	AC.045400E	20
	AC.045400E27B	20
	AC.045400E27W	20
	AC.045400GE	20
	AC.045400LE	20
	AC.04544Y2	97
	AC.04544Y4	97
	AC.04597Y2	97
	AC.04597Y3	97
	AC.045B813G	72
	AC.045B813GAB	72
	AC.045B813GM	72
	AC.045B813N	72
	AC.045B813NM	72
	AC.045B813W	72
	AC.045BS812S	83
	AC.045BS9222	39
	AC.045BS9222EG	39
	AC.045BS9222W	39
	AC.045BS9223EG	39
	AC.045BS9223W	39
	AC.045D02A	39
	AC.045F25A	115
	AC.045F25K	115
	AC.045F30A	115
	AC.045F30K	115
	AC.045F35A	115
	AC.045F35K	115
	AC.045GL63B	40
	AC.045GL63G	40
	AC.045GL63W	40
	AC.045GL64B	40
	AC.045GL64G	40
	AC.045GL64W	40
	AC.045GL76	42
	AC.045GL77	42
	AC.045GL77G	42
	AC.045GL78	42
	AC.045GL79	42
	AC.045GL79G	42
	AC.045H150CB	18
	AC.045H150CG	18
	AC.045H150CW	18
	AC.045H70CB	18
	AC.045H70CG	18
	AC.045H70CW	18
	AC.045H75B	101

	AC.045H75M	101
	AC.045MR16CB	69
	AC.045MRCHG	69
	AC.045MRCHN	69
	AC.045PBB	37
	AC.045PBG	37
	AC.045PBW	37
	AC.045R50B	65
	AC.045R50G	65
	AC.045R50GAB	65
	AC.045R50GM	65
	AC.045R50GO	65
	AC.045R50NM	65
	AC.045R50RAB	65
	AC.045R50W	65
	AC.045R63B	65
	AC.045R63G	65
	AC.045R63GAB	65
	AC.045R63GM	65
	AC.045R63GO	65
	AC.045R63KNM	65
	AC.045R63KNMA	65
	AC.045R63KW	65
	AC.045R63NM	65
	AC.045R63NMA	65
	AC.045R63RAB	65
	AC.045R63W	65
	AC.045R80B	65
	AC.045R80GAB	65
	AC.045R80GM	65
	AC.045R80GO	65
	AC.045R80NM	65
	AC.045R80RAB	65
	AC.045R80W	65
	AC.045SP05	19
	AC.045SP05	19
	AC.045XF001B	89
	AC.045XF001F	90
	AC.045XF001J	94
	AC.045XF002B	89
	AC.045XF002F	90
	AC.045XF002JB	94
	AC.045XF003B	89
	AC.045XF003F	90
	AC.045XF003J	94
	AC.045XF004B	89
	AC.045XF004F	90
	AC.045XF004JB	94
	AC.045XF004R	88
	AC.045XF04DR	95
	AC.045XF04DS	95
	AC.045XF04GR	95
	AC.045XF100	86
	AC.045XF100A	86
	AC.045XF12E	118
	AC.045XF12G	117
	AC.045XF200	86
	AC.045XF200B	86
	AC.045XF218C	59
	AC.045XF218D	59
	AC.045XF221A	59
	AC.045XF221B	59
	AC.045XF300G	67
	AC.045XF31	115
	AC.045XF330G	115

AC.045XF40A	115
AC.045XF44W	114
AC.045XF47	115
AC.045XF8028	100
AC.045XF803B	101
AC.045XF828A	42
AC.045XF828AG	42
AC.045XF828G	100
AC.045XFFL2	47
AC.045XFGJ3	94
AC.045XFGJ4S	94
AC.045XFFG	72
AC.045XFFN	72
AC.045XFFW	72
AC.045XFS13A	101
AC.045XFST13	101
AC.045XFST3	99
AC.045XFST4	99
AC.045XFST5	99
AC.045XFST6	100
AC.045XFST6T4	104
AC.045XFST7T	104
AC.045XFST7T4	104
AC.045XFW10D	76
AC.045XFWL19	113
AC.045XFWL25	85
AC.045XFWL26	85
AC.045XFWL27	85
AC.045XFWL28	85
AC.045XFWL29	85
AC.045XFWL30	85
AC.045XFWL31	85
AC.045XFWL39	85
AC.045XFWL40	85
AC.045XFWL40	85
AC.045XFWL41	119
AC.045XFWL41GA	119
AC.045XFWL48	84
AC.045XFWL56	77
AC.045XFWL7	86
AC.045XFWL8	86
AC.045XM2931	103
AC.0979RBL	89
AC.0979RGR	89
AC.0979RRE	89
AC.0979RVI	89
AC.0979RYE	89
AC.09998	20
AC.09999	20
AC.1000	58
AC.1001	58
AC.1001L	58
AC.1001LED	58
AC.1001T	58
AC.1002	58
AC.1002LED	58
AC.1003	58
AC.1003L	58
AC.1003LED	58
AC.1003T	58
AC.1004	58
AC.1004L	58
AC.1004LED	58
AC.1004T	58
AC.1005	58

AC.1005C	58
AC.1006	58
AC.1007	58
AC.1008	58
AC.1009	58
AC.1011	58
AC.1012	58
AC.1013	58
AC.1014	58
AC.1061	58
AC.10610	58
AC.10611	58
AC.10612	58
AC.10613	58
AC.1061L	58
AC.1061LED	58
AC.1061T	58
AC.1062	58
AC.1062LED	58
AC.1063	58
AC.1063L	58
AC.1063LED	58
AC.1063T	58
AC.1064	58
AC.1064L	58
AC.1064LED	58
AC.1064T	58
AC.1065	58
AC.1066	58
AC.1067	58
AC.1068	58
AC.1069	58
AC.1124	14
AC.11241	14
AC.11251	14
AC.11252	14
AC.1150NAP	13
AC.1150NP	11
AC.1160M	11
AC.1160MA	13
AC.1250M	11
AC.1250MA	13
AC.1250NAP	13
AC.1250NP	11
AC.1273	13
AC.170NAP	13
AC.170NP	11
AC.18008	21
AC.18017	21
AC.1801L	24
AC.1801LM	24
AC.1801PM	24
AC.1801PO	24
AC.180725C	22
AC.180725G	22
AC.180730C	22
AC.180730G	22
AC.18250KCL	23
AC.18250KGO	23
AC.18250KOP	23
AC.18250KSM	23
AC.18272	22
AC.18272GH	23
AC.1837	22
AC.1837G	22

AC.1837LG	22
AC.1837LGH	23
AC.1837LO	22
AC.1837SG	22
AC.1837SO	22
AC.18401HP	11
AC.18401M	11
AC.18401NP	11
AC.18405NP	11
AC.18W	23
AC.19127NM	67
AC.19127W	67
AC.2160M	7
AC.2250M	7
AC.28021	25
AC.28022	25
AC.28031	25
AC.28032	25
AC.280W1	24
AC.280W3	24
AC.3118H	50
AC.3136H	50
AC.3158H	50
AC.3160M	15
AC.3160MB	15
AC.31901	16
AC.31901G	16
AC.319RE	16
AC.3218H	50
AC.3236H	50
AC.3250M	15
AC.3258H	50
AC.3530	21
AC.3530G	22
AC.3530M	21
AC.3530T	21
AC.3531	21
AC.3531C	22
AC.3531G	22
AC.3531M	21
AC.3531T	21
AC.3532	21
AC.3532C	22
AC.3532G	22
AC.3532M	21
AC.3532T	21
AC.3533GO	24
AC.3533M	21
AC.3533SM	24
AC.3534	21
AC.3534C	22
AC.3534CA	22
AC.3534G	22
AC.3534M	21
AC.3534T	21
AC.3535	21
AC.3FYGC121	16
AC.3FYGC122	15
AC.3XF15	114
AC.3XF153	114
AC.3XF15A	114
AC.3XF15B	114
AC.3XF22	114
AC.3XF26	114
AC.3XF32	114

AC.3XF37	114
AC.3XF38	114
AC.3XF41	114
AC.3XF43	114
AC.3XF48	114
AC.4100AB	10
AC.4121GL	15
AC.4121GSG	16
AC.4122GS	15
AC.41CUR	14
AC.41M	14
AC.41MA	14
AC.41MB	14
AC.41MKK1A	10
AC.41MKK2	10
AC.4801A3	26
AC.4KALA7	15
AC.4PME	11
AC.4PMI	11
AC.4SM	14
AC.5114FC	53
AC.5114FH	53
AC.5118FC	51
AC.5118FCL	51
AC.5118FH	52
AC.5118FHL	52
AC.5128FC	53
AC.5128FH	53
AC.5135FC	53
AC.5136FC	51
AC.5136FCE	51
AC.5136FCL	51
AC.5136FH	52
AC.5136FHL	52
AC.51418FE	52
AC.5214FC	53
AC.5214FH	53
AC.5214OE	53
AC.5214WE	53
AC.5218FC	51
AC.5218FCL	51
AC.5218FH	52
AC.5218FHL	52
AC.5228FC	53
AC.5228FH	53
AC.5228OE	53
AC.5228WE	53
AC.5235FC	53
AC.5236FC	51
AC.5236FCE	51
AC.5236FCL	51
AC.5236FH	52
AC.5236FHL	52
AC.5249FC	53
AC.5258FC	51
AC.5258FCL	51
AC.5258FH	52
AC.5258FHL	52
AC.5314FH	53
AC.5324FH	53
AC.5414FC	53
AC.5414FH	53
AC.5418FC	51
AC.5418FCE	51
AC.5418FCL	51

AC.5418FH	52
AC.5418FHL	52
AC.5418FM	52
AC.5418FP	52
AC.5418FR	52
AC.5424FH	53
AC.5428FC	53
AC.5436FC	51
AC.5436FCL	51
AC.5436FHL	52
AC.5455FH	52
AC.54C	52
AC.6001SWC	73
AC.6003WC	73
AC.6012WC	73
AC.7114	50
AC.7118FBB	50
AC.7118LED	50
AC.7118PCE	50
AC.7128	50
AC.7135	50
AC.7136FBB	50
AC.7136LED	50
AC.7136PCE	50
AC.7158FBB	50
AC.7158LED	50
AC.7158PCE	50
AC.7214	50
AC.7218FBB	50
AC.7218LED	50
AC.7218PCE	50
AC.7228	50
AC.7235	50
AC.7236FBB	50
AC.7236LED	50
AC.7236PCE	50
AC.7258LED	50
AC.7258PCE	50
AC.7HOOKS	50
AC.7SEC	50
AC.7SSC	50
AC.F5118	51
AC.F5136	51
AC.F5136L	51
AC.F5218L	51
AC.F5236	51
AC.F5236L	51
AC.F5258L	51
AC.F5418	51
AC.F5418L	51
AC.F5436L	51
AC.ISRLE27MF	11
AC.ISRLE40MF	12
AC.ISRN150P	12
AC.ISRN250P	12
AC.ISRN400P	12
AC.ISRN70P	11
AC.NF1824	21
AC.NF2804A1	25
AC.NFW6005	26
AC.NFW6010	26
AC.NFWA1	26
AD4SG	112
AMM3	10
APT51X14	54

B	APT51X21	54
	APT51X8	54
	ARGF	22
	ARGF40	22
	B020DL	116
	B026DL	116
	B027DL	116
	BPG9	116
	BS125FDNM	73
	BS125FENM	73
	BS3122NM	76
	BS3153AGM	63
	BS3153AN	63
	BS3153ANM	63
	BS3153AW	63
	BS3153GM	63
	BS3153N	63
	BS3153NCP	63
	BS3153NG	63
	BS3153NGAB	63
	BS3153NGM	63
	BS3153NM	63
	BS3153NNM	63
	BS3153NRAB	63
	BS3153NSG	63
	BS3153NW	63
	BS3153W	63
	BS3154CPMR11	70
	BS3154EGMR11	70
	BS3154GABMR11	70
	BS3154GMMR11	70
	BS3154NMMR11	70
	BS3154WMMR11	70
	BS3159CPMR16	70
	BS3159EGMR16	70
	BS3159GABMR16	70
	BS3159GMMR16	70
	BS3159NMMR16	70
	BS3159WMMR16	70
	BS3161CP	62
	BS3161G	62
	BS3161GAB	62
	BS3161GM	62
	BS3161N	62
	BS3161NM	62
	BS3161RAB	62
	BS3161SG	62
	BS3161W	62
	BS3167NM	71
	BS3167W	71
	BS3181GMB	74
	BS3181GMW	74
	BS3181NMB	74
	BS3181NMW	74
	BS3234FNM	71
	BS3259EG	68
	BS3259GM	68
	BS3259GPBG	68
	BS3259GPG	68
	BS3259SPNMS	68
	BS3261CPMR16	71
	BS3261EGMR16	71
	BS3261GABMR16	71
	BS3261GMMR16	71
	BS3261NMMR16	71

	BS3262CPMR11	71
	BS3262EGMR11	71
	BS3262GABMR11	71
	BS3262GMMR11	71
	BS3262NMMR11	71
	BS3371GAB	69
	BS3371GM	69
	BS3371NM	69
	BS3371W	69
	BS3404NM	64
	BS3405NM	64
	BS3406GAB	64
	BS3406GM	64
	BS3406NM	64
	BS3407GAB	64
	BS3407GM	64
	BS3407NM	64
	BS3601	89
	BS3601N	90
	BS3602	90
	BS3602N	90
	BS3603	90
	BS3603N	90
	BS3604	90
	BS49T2BN	102
	BS49T2GN	102
	BS49T2SG	102
	BS49T2W	102
	BS49T2WN	102
	BS805GAB	83
	BS805GM	83
	BS805NM	83
	BS805W	83
	BS812GAB	72
	BS812GM	72
	BS812S1NMS	83
	BS820GAB	76
	BS820GM	76
	BS820NM	76
	BS823NM	76
	BS9215GSG	83
	BS9216GSG	83
	BS92186SG	84
	BS92353SG	83
	BS9252NMCP	84
	BS92CNMCPWG9	74
	BS92RNMCPWG9	84
	BSP45	116
	BST2160A	6
	BST2160AN	6
	BST2160C	6
	BST2170A	6
	BST2170AR	6
	BST2590B	6
	BT1003BH030	34
	BT1003BH045	34
	BT1003BH080	34
	BT1003BUP	34
	BT1003H08	34
	BT1003SO	34
	BT1003WU	34
	BT1008SENSOR	34
	BT1008SO	34
	BT1008WU	34
	BT5721	33

C	BT9013A	42
	BT9013AG	42
	BT9013B	42
	BT9013BG	42
	BT9013GBR	42
	BT9013R	42
	BT9013W	42
	BT9013WG	42
	BT9014G	42
	CAB0414W	60
	CAB0421W	60
	CAB048W	60
	CBA26	92
	CBCDMR	92
	CBCDMR111	92
	CBCDMR111B	93
	CBCDMRB	93
	CBCDMRWH	92
	CBCDMT	92
	CBCDMTB	93
	CBCDMTWH	92
	CBQR111	92
	CBQR111B	93
	CBQR111WH	92
	CYCLEA	28
	CYCLEA1M	28
D	DEL0913	14
	DEL1X18	49
	DEL1X36	49
	DEL1X58	49
	DEL2X18	49
	DEL2X36	49
	DEL2X58	49
	DELED120	48
	DELED120L	48
	DELED120M	48
	DELED150	48
	DELED150L	48
	DELED150M	48
	DELED2120M	48
	DELED2150M	48
	DELED260M	48
	DELED290M	48
	DELED60	48
	DELED60L	48
	DELED60M	48
	DELED90	48
	DELED90L	48
	DELED90M	48
	DELTA1X18	49
	DELTA1X18L	49
	DELTA1X36	49
	DELTA1X36L	49
	DELTA1X58	49
	DELTA1X58L	49
	DELTA2X18	49
	DELTA2X18L	49
	DELTA2X36	49
	DELTA2X36L	49
	DELTA2X58	49
	DELTA2X58L	49
	DZDIY2MT1MW	110
	DZDIY2MT2MW	110
	DZDIY2MTI	110
	DZDIY2MTI	95

	DZDIY2MTIW	110
	DZDIY2MTL	110
	DZDIY2MTL	95
	DZDIY2MTT	110
	DZDIY2MTT	95
	DZDIY2MTX	110
	DZDIY2MTX	95
	DZDIY2MT15M	110
	DZDIY2MT15M	95
	DZDIY2MT2M	95
	DZDIY2MT3M	110
	DZDIY2MT3M	95
	DZDIYAL15M	95
	DZDIYAL1M	95
	DZDIYAL2M	95
	DZDIYAL3M	95
	DZDIYAMR16	96
	DZDIYAMR16	96
	DZDIYAQR111	96
	DZDIYCDMR	96
	DZDIYCDMR111	96
	DZDIYCDMT	96
	DZDIYHQI	96
	DZDIYI	95
	DZDIYL	95
	DZDIYQR111	96
	DZDIYT	95
	DZDIYT5314W	96
	DZDIYT5321W	96
	DZDIYT5335W	96
	DZDIYX	95
E	E400SBN202	19
	E400SBN350	19
	EKOB	78
	EKONM	78
	EKOSG	78
	EKOW	78
	ERKE118IP440	56
	ERKE136IP44P	56
	ERKE236IP440	56
	ERKE236IP44P	56
	ERKE418IP440	56
	ERKE418IP44P	56
F	F10GU104KB	105
	F10GU104KG	105
	F10GU104KW	105
	F601142M	10
	F601143M	10
	F601144M	10
	F761403M	10
	F761404M	10
	F76TAP	10
	F862A	13
	F891404M	10
	F891405M	10
	F8GU104KB	105
	F8GU104KG	105
	F8GU104KW	105
	FLER120	48
	FLER2120	48
	FLER260	48
	FLER290	48
	FLER60	48
	FLER90	48
	FYD863	13

G	FYG24CL	20
	FYGC10	16
	FYGT24	20
	FYGT303II	19
	FYGT33111C	20
	FYGT331II	20
	FYGT337I	19
	FYZD920	12
	FYZD920150H	12
	FYZD920150N	12
	FYZD920250H	12
	FYZD920250N	12
	FYZD920400H	12
	FYZD920400N	12
	FYZD920S	12
	FYZD920S150H	12
	FYZD920S150N	12
	FYZD920S250H	12
	FYZD920S250N	12
	FYZD920S400H	12
	FYZD920S400N	12
	FYZW626I	47
	G020DL	116
	G026DL	116
	G027DL	116
	GD15TTN4MT	109
	GD16TTN4MT	109
	GD18PTN4MT	108
	GD18PTN4MTB	108
	GD18PTN4MTW	108
	GD18QTN4MT	106
	GD18QTN4MTB	106
	GD18QTN4MTW	106
	GD19RTN4MT	108
	GD19RTN4MTB	108
	GD20TTN4MT	109
	GD20TTN4MTB	109
	GD20TTN4MTW	109
	GD35CBTN4MT	108
	GD35CBTN4MTW	108
	GD35GU10TN4MTW	108
	GDBA	109
	GDBAB	109
	GDBAW	109
	GL111B	88
	GL111W	88
	GL180B	88
	GL180W	88
	GL280B	88
	GL280W	88
	GL5300467B	69
	GL5300467W	69
	GL5300468B	69
	GL5300468W	69
	GL810001	64
	GL810002	64
	GL810006	64
	GL810007	64
	GNT514ML	57
	GNT514MLF	57
	GNT528ML	57
	GNT528MLF	57
	GR020BL	14
	GR020L	14
	GR026L	14

H	GSP45	116
	HI019AG9	40
	HI10321100	36
	HI1032400	36
	HI1032650	36
	HI234060	10
	HI4101	46
	HI4102	46
	HI4111	46
	HI4113	46
	HI4142	39
	HI4143	39
	HI5001B	37
	HI5001G	37
	HI5001GB	37
	HI5001R	37
	HI5001W	37
	HI5002B	37
	HI5002G	37
	HI5002GB	37
	HI5002R	37
	HI5002W	37
	HI50030	8
	HI501133	8
	HI5011B	37
	HI5011G	37
	HI5011GB	37
	HI5011R	37
	HI5011W	37
	HI501201	8
	HI501261	8
	HI5012B	37
	HI5012G	37
	HI5012GB	37
	HI5012R	37
	HI5012W	37
	HI5021B	37
	HI5021G	37
	HI5021GB	37
	HI5021R	37
	HI5021W	37
	HI5022B	37
	HI5022G	37
	HI5022GB	37
	HI5022R	37
	HI5022W	37
	HI5031B	37
	HI5031G	37
	HI5031GB	37
	HI5031R	37
	HI5031W	37
	HI5032B	37
	HI5032G	37
	HI5032GB	37
	HI5032R	37
	HI5032W	37
	HI5033B	37
	HI5033G	37
	HI5033GB	37
	HI5033W	37
	HI5042B	38
	HI5042G	38
	HI5042GB	38
	HI5042W	38
	HI5044B	38

	HI5044G	38
	HI5044GB	38
	HI5044W	38
	HI5072B	38
	HI5072G	38
	HI5072GB	38
	HI5072W	38
	HI5073B	38
	HI5073G	38
	HI5073GB	38
	HI5073W	38
	HI5074B	38
	HI5074G	38
	HI5074GB	38
	HI5074W	38
	HI5122	38
	HI5123	38
	HI5132	38
	HI5133	38
	HI5171B	38
	HI5171G	38
	HI5171W	38
	HI5172B	38
	HI5172G	38
	HI5172W	38
	HI5191	38
	HI5192	38
	HI5193	38
	HI5194	38
	HI5261B	38
	HI5261G	38
	HI5261W	38
	HI5262B	38
	HI5262W	38
	HI5263B	38
	HI5263G	38
	HI5263W	38
	HI5502	39
	HI5601	39
	HI5611	39
	HI5612	39
	HI5701	39
	HI5702	39
	HI5703	39
	HI6021B	29
	HI6021GB	29
	HI6021R	29
	HI6021V	29
	HI6021W	29
	HI6022B	29
	HI6022GB	29
	HI6022R	29
	HI6022V	29
	HI6022W	29
	HI6023B	29
	HI6023GB	29
	HI6023R	29
	HI6023V	29
	HI6023W	29
	HI6024B	29
	HI6024GB	29
	HI6024V	29
	HI6024W	29
	HI6025B	29
	HI6025GB	29

	HI6025V	29
	HI6025W	29
	HI6041B	30
	HI6041GB	30
	HI6041R	30
	HI6041V	30
	HI6041W	30
	HI6042B	30
	HI6042GB	30
	HI6042R	30
	HI6042V	30
	HI6042W	30
	HI6043B	30
	HI6043GB	30
	HI6043R	30
	HI6043V	30
	HI6043W	30
	HI6044B	30
	HI6044GB	30
	HI6044R	30
	HI6044V	30
	HI6044W	30
	HI6045B	30
	HI6045GB	30
	HI6045R	30
	HI6045V	30
	HI6045W	30
	HI60CM	14
	HI6171B	31
	HI6171GB	31
	HI6171V	31
	HI6172B	31
	HI6172GB	31
	HI6172V	31
	HI6173B	31
	HI6173GB	31
	HI6173V	31
	HI6175B	31
	HI6175GB	31
	HI6175V	31
	HI6202	32
	HI6221V	32
	HI6222V	32
	HI6223GB	32
	HI6223V	32
	HI6225B	32
	HI6225V	32
	HI6501	33
	HI6502	33
	HI6503	33
	HI7001	46
	HI7001B	44
	HI7001R	44
	HI7001W	44
	HI7002	46
	HI7002B	44
	HI7002E27	40
	HI7002R	44
	HI7002W	44
	HI7031A	45
	HI7031AL	45
	HI7031AM	45
	HI7031B	44
	HI7031G	44
	HI7031R	44

	HI7031W	44
	HI7032A	45
	HI7032AB	44
	HI7032AG	44
	HI7032AL	45
	HI7032AR	44
	HI7032AW	44
	HI7033A	45
	HI7033AR	44
	HI7033AW	44
	HI7061	45
	HI7061M	45
	HI7071	45
	HI7072	45
	HI7171	45
	HI7172	45
	HI7182NBL	42
	HI7182NGR	42
	HI7183	42
	HI7183B	42
	HI7183R	42
	HI7232A	46
	HI7261	36
	HI7262	36
	HI7263	36
	HI7331	47
	HI7333	47
	HI7355	45
	HI7361	46
	HI7362	46
	HI7363	46
	HI7371	47
	HI7371M	47
	HI7372	47
	HI7372M	47
	HI7373	47
	HI8001G	8
	HI8002G	8
	HI8003G	8
	HI8011B	33
	HI8011GB	33
	HI8011R	33
	HI8021	35
	HI80231050	35
	HI8023500	35
	HI80641100	35
	HI8064650	35
	HI8111	8
	HI8112	8
	HI8123	34
	HI8133	34
	HI8134300	34
	HI8134740	34
	HI8142	39
	HI8154	39
	HI8155	39
	HI8161	35
	HI81631100	35
	HI8163450	35
	HI8171	35
	HI8362GB	36
	HI8362GR	36
	HI8363650GB	36
	HI8363650GR	36
	HI80073	10

	HI8002	10
	HIPC1000B	26
	HIPC1000G	26
	HIPC1000R	26
	HIPC1000V	26
	HIPC500B	26
	HIPC500G	26
	HIPC500V	26
	HLSGMU019	7
I	INTERNY11424	55
	INTERNY12139	55
	INTERNY12854	55
	INTERNY13549	55
	INTERNY180	55
	INTERNY21424	55
	INTERNY22139	55
	INTERNY22854	55
	INTERNY23549	55
	INTERNY280	55
K	KERTCOV	41
	KERTCOV	41
	KERTGU10B	41
	KERTGU10G	41
	KERTGU10W	41
	KERTSGU10B	41
M	MB08014WGAB	119
	MB08014WNNM	119
	MB0808WGAB	119
	MB09614WGAB	119
	MB09614WNNM	119
	MB0968WGAB	119
	MB8223GAB	119
	MB8223NM	119
	MC1001BG	87
	MC1001G	87
	MC1002BG	87
	MC1002G	87
	MC1003BG	87
	MC1003G	87
	MC45	55
	MC52180	55
	MC5290	55
	MCP180	55
	MCP90	55
	MD67051A	59
	MD930AY28X2	57
	MD930B	57
	MD932B	57
	MD932O	57
	MD932Y	57
	MD932Y28X2	57
	ME1080CDMR	93
	ME1080CDMT	93
	ME1080QR111	93
	ME1080TC	93
	ME1080TCW	93
	MQ513021A	75
	MQ613021D	75
	MQ613051A	75
N	NF2805A1	25
	NF2805A2	25
	NF4801A1B	26
	NF4802AB	26
	NF4802AC	26
	NF4802AG	26

NF4802AY	26
NK009CB	112
NK010GY	112
P PA111	121
PA16	121
PA211	121
PA26	121
PA311	121
PA36	121
PB626	47
PCL11	120
PCL60	120
PCOFC1	120
PCOFC3	120
PCOFC4	120
PEL10	120
PEL14	120
PEL25	120
PEL3	120
PEL6	120
PFF005	120
PFF006	120
PFF012	120
PFF017	120
PFF022	120
PFF025	120
PLGM1B	28
PLGM1W	28
PLGM3B	28
PLGM3W	28
PLGM5B	28
PLGM5W	28
PLGP1B	27
PLGP1R	27
PLGP1W	27
PLGP3B	27
PLGP3R	27
PLGP3W	27
PLGP5B	27
PLGP5R	27
PLGP5W	27
PLGQ1B	27
PLGQ1R	27
PLGQ1W	27
PLGQ3B	27
PLGQ3R	27
PLGQ3W	27
PLGQ5B	27
PLGQ5R	27
PLGQ5W	27
PS118IP400	56
PS136IP400	56
PS158IP400	56
PS218IP400	56
PS236IP400	56
PS258IP400	56
PS418IP400	56
PSL11	120
PSL6	120
PSTL075	120
PSTL1	120
PSTL15	120
Q Q41114KB	106
Q41114KG	106
Q41114KW	106

R Q5135E	49
Q5235E	49
R020DL	116
R026DL	116
R027DL	116
R150SBN200	18
R150SBN350	18
R150SBN746	18
R150SBN747	18
RANGER A	79
RANGER B	79
RECY11424	55
RECY12139	55
RECY12854	55
RECY13549	55
RECY180	55
RECY21424	55
RECY22139	55
RECY22854	55
RECY23549	55
RECY280	55
RENO A	81
RENO B	81
RENO C	82
RENO D	82
ROMEA A	80
ROMEA B	80
RSP45	116
S S0016	5
S0018	7
S0019	7
S0022E27	5
S0022E40	5
S0022RX7S	5
S0050	7
S7009	73
S7226	73
SD8016T4G4	73
SDLCB1180F	92
SDLCB1180FR	92
SDLCB1180FRB	92
SDLCB1180FRW	92
SDLCB1180FW	92
SDLCB2180F	92
SDLCB2180FW	92
SDLCB3180F	92
SDLCB3180FW	92
SDLCB4180F	92
SDLCB4180FR	92
SDLCDMR	91
SDLCDMR111	91
SDLCDMR111N	91
SDLCDMRN	91
SDLCDMT	91
SDLCDMTN	91
SDLDH1001B	91
SDLDH1001BN	91
SDLDH1002B	91
SDLDH1003B	91
SDLDH1003BN	91
SDLDH1004B	91
SDLDH1004BN	91
SDLDH1014B	91
SDLDH1014BN	91
SDLFCB1180A	93

SDLFCB2180A	93
SDLFCB3180A	93
SDLFCB4180A	93
SDLQR111 91	91
SDLQR111N	91
SL7030B	43
SL7030G	43
SL7030R	43
SL7030W	43
SL7031B	43
SL7031G	43
SL7031R	43
SL7031W	43
SL7032B	43
SL7032BS	43
SL7032G	43
SL7032GS	43
SL7032R	43
SL7032RS	43
SL7032W	43
SL7032WS	43
SOLAR1TL1	97
SOLAR1WOF	97
SP60	10
SP89	10
SPKF43	52
SPT51X21	54
SPT51X28	54
SPT52X21	54
SPYDIE27B	103
SPYDIE27G	103
SPYDIE27W	103
SS008	117
SS015	117
SS020	118
SS022	118
SS036T400	118
T STKN	53
SW52	55
T508Y081	60
T5114E	49
T5114RE	49
T5128E	49
T5128RE	49
T5135RE	49
T5214E	49
T5214RE	49
T521Y081	60
T5228E	49
T5228RE	49
T5235RE	49
T8118RE	49
T8136RE	49
T8158RE	49
T8218RE	49
T8236RE	49
T8258RE	49
TH3118LED	49
TH31218LED	49
TH3136LED	49
TH3158LED	49
TH3236LED	49
TH3258LED	49
TL114D	53
TL114O	53

TL128D	53
TL128O	53
TL135D	53
TL135O	53
TS13PAR3CB	104
TS13PAR3CWG	104
TS13PAR4CB	107
TS13PAR4CWG	107
TS40GU3CNM	102
TS40GU4CNM	105
TS67GU3CB	102
TS67GU3CW	102
TS67GU4CB	105
TS67GU4CW	105
TS68AR3CB	103
TS68AR3CG	103
TS68AR3CW	103
TS68AR4CB	106
TS68AR4CG	106
TS68AR4CW	106
TS68GU3CB	102
TS68GU3CG	102
TS68GU3CW	102
TS68GU4CB	105
TS68GU4CG	105
TS68GU4CW	105
TS68PAR3CB	104
TS68PAR3CG	104
TS68PAR3CW	104
TS68PAR4CB	107
TS68PAR4CG	107
TS68PAR4CW	107
TS75GU3CB	102
TS75GU3CW	102
TS75GU4CB	105
TS75GU4CW	105
V V221981C	98
V221981T	98
V221981W	98
V221982C	98
V221983F	98
V221984C	98
V221984PAL	98
V221986PAL	98
V222001TLI	97
V222003CSI	97
V222004CSQ	97
VS218IP20	56
VS218IP20E	56
VS236IP20	56
VS236IP20E	56
VS258IP20	56
VS258IP20E	56
VS418IP20	56
VS418IP20E	56
VS418IP20I	56
W W1X18GREY	56
W1X36GREY	56
WE2SG	110
WH4SG	112
WI4SG	112
WT4SG	112
WTSG	110
WTW	110
WX4SG	112

X XF002C	89
XF003C	89
XF004C	89
XF9014	83
XF9018GU10	40
XFSP001S	86
XFST27C	101
XFST29A	100
XFST29AT	107
XFWL1A	75
XFWL21AG9	77
XFWL21G9	77
XFWL2A	75
XFWL33	77
XFWL35	77
XFWL36	84
XFWL36BG9	84
XFWL37	84
XFWL37BG9	84
XFWL38	84
XFWL44	85
XFWL44A	85
XFWL4B	76
XFWL58S	119
XFWL64 8	5
XFWL65	85
XFWL77JC	77
XFWL78JC	77
XFWL80B	46
XFWL80C	46
XFWL80D	46
XFWL81AG9	40
XFWL81G9	40
XFWL90	86
XM2475SG	109
XM2707GABW	75
XM2707GMW	75
XM2707NMW	75
XM2708AB	74
XM27311621B	74
XM27311621W	74
XM2901PSG	94
XM2901SNM	88
XM2902S1SG	88
XM2902SB	88
XM2902SNM	88
XM2902SW	88
XM2903SNM	88
XM2904SNM	88
XM2905SSNM	88
XM5201G9	113
XM5202G9	113
XM5213GU10	113
XM5222E27	113
XM5707SGG9	113
Y YZDH702	12

ΟΡΟΙ ΠΩΛΗΣΕΩΝ (GREEK)

Τα εμπορεύματα παραδίδονται συσκευασμένα στην έδρα σας για τις πόλεις της Αθήνας και της Θεσσαλονίκης ενώ για την επαρχία στο πρακτορείο της επιλογής σας. Οι αποστολές παραγγελιών χαμηλότερης τιμολογιακής αξίας χωρίς Φ.Π.Α. των **50€** θα επιβαρύνουν τον αγοραστή με τα ανάλογα κόμιστρα.

Η μεταφορά των προϊόντων επιβαρύνει τον αγοραστή και ο κίνδυνος που προκύπτει από αυτή είναι αποκλειστικά ευθύνη του.

Οι συσκευασίες των προϊόντων είναι δεδομένες και όσον αφορά τα προϊόντα χαμηλής αξίας, προτείνουμε την αγορά συσκευασίας.

Επιστροφές προϊόντων θα γίνονται δεκτές **μόνο κατόπιν συνεννόησης με την εταιρεία** και ακολουθώντας τους ειδικούς όρους επιστροφών. Τα επιστρεφόμενα θα πρέπει να είναι άρτια, αχρησιμοποιήτα και στις συσκευασίες τους για να γίνουν δεκτά.

Επιστροφές προϊόντων που οφείλονται σε λάθος παραγγελία του αγοραστή, θα τιμολογούνται (πιστωτικό) στο **85%** της αξίας τους.

Οποιοδήποτε υλικό δεν λειτουργεί λόγω αστοχίας του εργοστασίου, η εταιρεία μας είναι υπεύθυνη για την επισκευή/επιδιόρθωσή του.

Για προϊόντα που έχουν χρησιμοποιηθεί και παρουσιάσουν βλάβες, σπασμένα εξαρτήματα, φθορές κλπ, η εταιρεία μας παρέχει χρεώσιμο service υπό την προϋπόθεση ότι είναι διαθέσιμα τα απαραίτητα ανταλλακτικά.

Το χρώμα και η διάσταση των φωτιστικών ενδέχεται να έχουν μια μικρή απόκλιση από παρτίδα σε παρτίδα.

Η εταιρεία έχει το δικαίωμα να καταργήσει κωδικούς προϊόντων χωρίς προειδοποίηση.

Οι τιμές των προϊόντων μπορούν να αλλάξουν χωρίς προειδοποίηση.

Η εταιρεία δεν ευθύνεται για τυχόν τυπογραφικά λάθη.

ΠΡΟΣΟΧΗ η εταιρεία δεν ευθύνεται για ενδεχόμενες φθορές στη βαφή προϊόντων που έχουν εγκατασταθεί σε παραθαλάσσιες περιοχές.

Η εταιρεία μας παραμένει κλειστή:

-Στις 25 Μαρτίου & 28 Οκτωβρίου

-Από τη Μ.Παρασκευή έως και τη δεύτερη ημέρα του Πάσχα

-Την εβδομάδα του Δεκαπενταύγουστου

-Την τελευταία εβδομάδα του χρόνου και την πρώτη του επομένου

ΟΡΟΙ ΕΠΙΣΤΡΟΦΩΝ:

(Παρακαλούμε ακολουθείτε τους όρους για την καλύτερη εξυπηρέτησή σας)

Απαραίτητη η συμπλήρωση όλων των πεδίων της **φόρμας επιστροφών** της εταιρείας μας, αποστολή μέσω φαξ ή mail και επιστροφή των προϊόντων **ΜΟΝΟ** κατόπιν επιβεβαίωσης της εταιρείας μας.

Επιστροφές γίνονται δεκτές μόνο εντός μηνός από την ημερομηνία του τιμολογίου και μόνο αν συνοδεύονται από δελτίο αποστολής και επιβεβαίωση της εταιρείας μας. Επίσης, τα υγιή προϊόντα θα πρέπει να είναι στη συσκευασία τους όπως αυτά στάλθηκαν σε εσάς.

Σε περίπτωση επιστροφής προϊόντος άλλης εταιρείας, ελαττωματικού προϊόντος στο οποίο δεν θα διαπιστωθεί βλάβη / δυσλειτουργία ή αυτή οφείλεται σε κακή χρήση / λάθος σύνδεση του εγκαταστάτη, θα υπάρχει χρέωση **5€** ανά κωδικό. Επίσης, στο Δελτίο Αποστολής θα πρέπει να αναγράφεται ευκρινώς η φράση **“ΠΡΟΣ ΕΛΕΓΧΟ”** ή **“ΠΡΟΣ ΕΠΙΣΚΕΥΗ”**.

Επιστροφές, οι οποίες μεταφέρονται σε συσκευασία, που δεν διασφαλίζει τη σωστή μεταφορά τους, δε γίνονται δεκτές.

Παρακαλούμε να γίνεται ενδελεχής έλεγχος κατά τη παραλαβή των παραγγελιών και να ενημερώνεται η εταιρεία την ίδια ημέρα για τυχόν φθορές.

TERMS OF SALES (ENGLISH)

The transport of products charged to the purchaser and the risk that arises from this is solely his responsibility. The packaging of products is standard and as for the low-value products , we recommend packaging market .

Returns will be accepted **only by prior arrangement with the company** and following special conditions returns. Returned products must be intact, unused and in their packaging to be accepted.

Product returns due to buyer wrong order, they are billed (credit) at **85%** of their value.

Any material not functioning due to the failure of the factory , our company is responsible for the repair.

For products used and processing defects , broken parts , damage etc. , our company provides billable service provided that the necessary parts are available.

The color and dimension of the luminaires may have a small declination from batch to batch.

The company has the right to remove product codes without notice.

The prices of the products can change without notice.

The company is not responsible for typographical faults.

ATTENTION the company is not liable for any damage to the paint products installed in coastal areas.

Our company remains closed :

-On March 25 and October 28

-From Good Friday until the second day of Easter

-The week of the Assumption

-In the last week of the year and the first of the following

RETURN TERMS :

(Please follow the requirements for your convenience)

Necessary to complete all fields of our company's **refund form** , send it via fax or mail and return the products **only** after confirmation of our company.

Returns are only accepted within one month of the date / time of the invoice and only if accompanied by a consignment note and confirmation of our company. Also, undamaged products must be in their packaging as they were sent to you.

The return of another's company product , defective product which will determine damage / malfunction or is attributable to misuse / wrong connection of the installer , there will be charge **5€** per code. Also, the Delivery Note shall be clearly marked “ **FOR INSPECTION** “ or “ **TO REPAIR** “.

Returns , which are transported in a package that does not ensure the proper transposition , are not accepted .

Please do a thorough check in the receipt of orders and inform the company on the same day for any possible damage.

PODMÍNKY PRODEJE (CZECH)

Náklady na přepravu zboží hradí kupující a riziko spojené s přepravou nese výhradně kupující.
Obaly zboží jsou dané, a pokud se jedná o zboží s nízkou hodnotou, pak doporučujeme zakoupení obalu.

Reklamací zboží lze vyhovět pouze **po dohodě se společností** a v souladu se zvláštními podmínkami pro navrácení zboží.

Při reklamaci zboží z důvodu chybně učiněné objednávky ze strany kupujícího bude počítáno **85%** z hodnoty tohoto zboží.

Naše společnost zajistí opravu/úpravu každého nefunkčního výrobku, za jehož nefunkčnost je zodpovědný výrobce.

Pokud jde o zboží, které bylo použito a u kterého se vyskytla vada, zlomené díly, opotřebením apod., naše společnost poskytuje placený servis za předpokladu, že jsou k dispozici příslušné náhradní díly.

Barva různých materiálů (sklo, textil, plast apod.) se může při zapnutém svítidle lišit, což přináší případné odchylky v odstínu a barvě.

Společnost je bez předchozího upozornění oprávněna zrušit některé výrobky.

Ceny výrobků mohou být bez předchozího upozornění zrušeny.

Společnost neodpovídá za případné tiskové chyby.

UPOZORNĚNÍ Společnost není odpovědná za případné poškození barvy výrobků instalovaných na pobřeží.

Naše společnost má zavřeno:

-25. Března a 28. Října

-Od Velkého pátku do druhého dne Velikonoc

-Týden kolem 15. Srpna

-Poslední týden v roce a první týden následujícího roku

REKLAMAČNÍ ŘÁD:

(Pro lepší vyřízení reklamace, dodržujte prosím následující podmínky)

Vyplňte všechna pole **reklamačního formuláře** naší společnosti, zašlete jej faxem nebo e-mailem a výrobek vraťte **POUZE** po vyjádření souhlasu naší společností.

Výrobek lze vrátit pouze ve lhůtě jednoho měsíce od data vystavení faktury a musí být k němu přiložen dodací list a souhlas naší společnosti. Výrobek musí být v balení, ve kterém Vám byl zaslán.

V případě vrácení výrobku jiné společnosti, vadného výrobku, u kterého nebyla zjištěna závada / nefunkčnost, nebo se tato vyskytla v důsledku nesprávného užívání / napojení od uživatele, bude účtován poplatek **5 EUR** za každý výrobek. Dále musí být v dodacím listu zřetelně napsáno "**KE KONTROLE**" nebo "**K OPRAVĚ**".

Nebude přijato zboží, které bude navraceno v obalech, jež nemohou zajistit jeho vhodnou přepravu.

Barva skla (v katalogu uvedeno: glass) může vykazovat rozdíly v odstínech a nepatrné bublinky z důvodu ručního barvení. V těchto případech nelze reklamaci vyhovět.

Při převzetí objednávky zkontrolujte důkladně zboží a v případě, že zjistíte jeho poškození, informujte tentýž den společnost.

УСЛОВИЯ ЗА ПРОДАВАНЕ (BULGARIAN)

Транспортирането на стоки за сметка на купувача и рискът, който възниква от това е само негова отговорност. Пакетирането на продуктите е стандартно, а за продукти с ниска стойност, ние препоръчваме на пазарни опаковки.

Връщането на продукти се приемат **само с предварителна уговорка с фирмата** и при спазване на специални условия за връщане.

Върнатите продукти трябва да са непокътнати, неизползвани и в оригиналната опаковка, за да бъдат приети.

Връщане на продукта поради грешка на купувача се таксува (кредитира) с **85%** от стойността им.

За всеки материал, който не функционира поради грешка на завода, нашата фирма е отговорна за ремонт.

За продукти, които са използвани и са показали дефекти, имат счупени части, щети и т.н., нашата фирмата осигурява безплатен сервиз, при условие че необходимите части са налични.

Цветът на различни материали (стъкло, тъкани, пластмаса и т.н.) може да варира в тон и нюанс, когато има изкуствено осветление.

Фирмата има правото да премахва продуктови кодове без предизвестие.

Цените на продуктите могат да се променят без предупреждение.

Фирмата не носи отговорност за печатни грешки.

ВНИМАНИЕ, фирмата не носи отговорност за щети на боядисаните продукти, намиращи се в крайбрежните райони.

Нашата компания е затворена:

-На 25 Март и 28 Октомври

-От Разпети Петък до втория ден на Великден

-Седмица на Успение Богородично

-През последната седмица на годината и първата на следващата година.

УСЛОВИЯ ЗА ВРЪЩАНЕ:

(Моля, спазвайте изискванията за ваше улеснение)

Необходимо да попълните всички полета на нашия **формуляр за възстановяване**, да го изпратите по факс или по пощата и да се върне продуктите **само** след потвърждение от нашата компания.

Връщането на продуктите се приемат само в рамките на един месец от датата / часа на фактурата и само ако са придружени от товарителница и потвърждение на нашата компания. Също така, неповредени продукти трябва да са в опаковката им, така като те са били изпратени до вас.

Връщането на продукти от друга компания, дефектен продукт, който ще нанесе повреда (неизправност или неправилна употреба), неправилно свързване на инсталатора, ще се начислява **5 €** на код. Също така, на документа за доставка трябва ясно да е отбелязано **“ЗА ПРОВЕРКА“** или **“ЗА РЕМОНТ“**.

Върнати продукти, които са транспортирани в опаковка, която не гарантира правилното им транспорт, не се приемат.

aca[®] Group

LIGHTING APOSTOLIDIS

CZECH REPUBLIC ACA LIGHTING CZECH s.r.o.



Greece

•Head Offices:

Industrial Area of Serres
P.C. 62100 | T.: +30 23210 77020-21 | F.: +30 23210 77022
info@acalight.gr

•Showroom:

1st klm of Serres - Drama
P.C. 62100 | T.: +30 23210 97790-8 | F.: +30 23210 97799
contact@acalight.gr

•Showroom 2:

26 Georgiou Papandreou | Serres
P.C. 62100 | T.: +30 23210 68500 | F.: +30 23210 68501
ilek@acalight.gr

•Athens Warehouses:

15 Palamidiou | Piraeus
P.C. 18545 | T.: +30 210 4251901 | F.: +30 210 4914696
sales10@acalight.gr

Czech Republic

•ACA Lighting Czech s.r.o.:

Nuselska 1545/128 | Praha 4 | Prague
P.C. 14000 | T.: +420 2225 20477
info@acalighting.cz

Bulgaria

•ACA Lighting BG LTD:

Christo Smirnenski 22A | Novo Delchevo village | Sandanski
P.C. 2814 | T.: +359 8954 12212
info@acalighting.bg

BULGARIA ACA LIGHTING BG LTD



CHINA DIOLAMP Co. LTD



GREECE
ACA LIGHTING
APOSTOLIDIS TRADING S.A.



aca Group[®]
LIGHTING APOSTOLIDIS

aca Group[®]
LIGHTING APOSTOLIDIS



www.acalight.gr